

ZERO TRACK

ZERO TRAC

ZERO TRA

ZERO TR

ZERO T

ZERO

ZER

ZE

Z

Innovative 24V system composed of an extremely miniaturised track that subtly adapts to the surface deceiving the eye: it causes an effect of recessed installation because of the simplicity of a surface mounted track. It integrates to all types of ceilings and walls, offering a variety of dimmable luminaires, including the Atom collection by Piero Lissoni and the Find Me collection by Jorge Herrera.

Sistema innovador de 24V compuesto por un carril de extrema miniaturización que se adapta sutilmente engañando al ojo: provoca un efecto de instalación empotrada por la simplicidad de su carril de montaje en superficie. Se integra en todo tipo de techos y paredes, ofreciendo una gran variedad de luminarias regulables, incluyendo la colección Atom de Piero Lissoni y la colección Find Me de Jorge Herrera.

ZERO TRACK

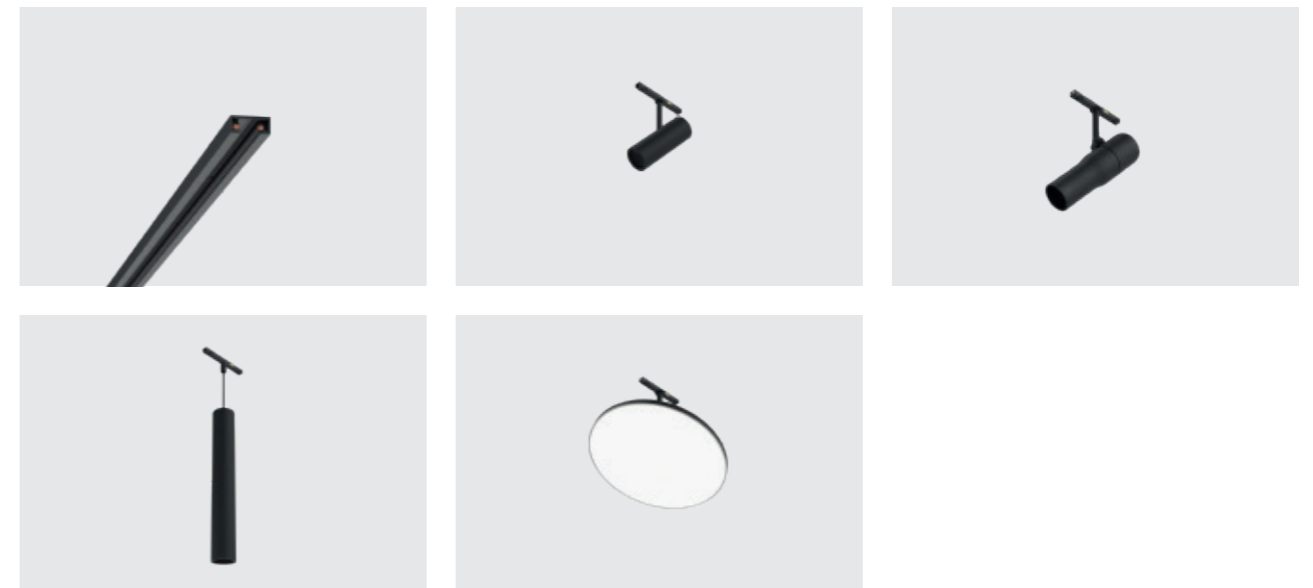



Restaurant Hert, Belgium



Total integration into different architectural spaces thanks to the minimal dimensions of the track surface and the stylish miniaturisation of the spotlights.

Adaptación total a diferentes espacios arquitectónicos gracias a las dimensiones mínimas de la superficie del carril y la elegante miniaturización de los proyectores.

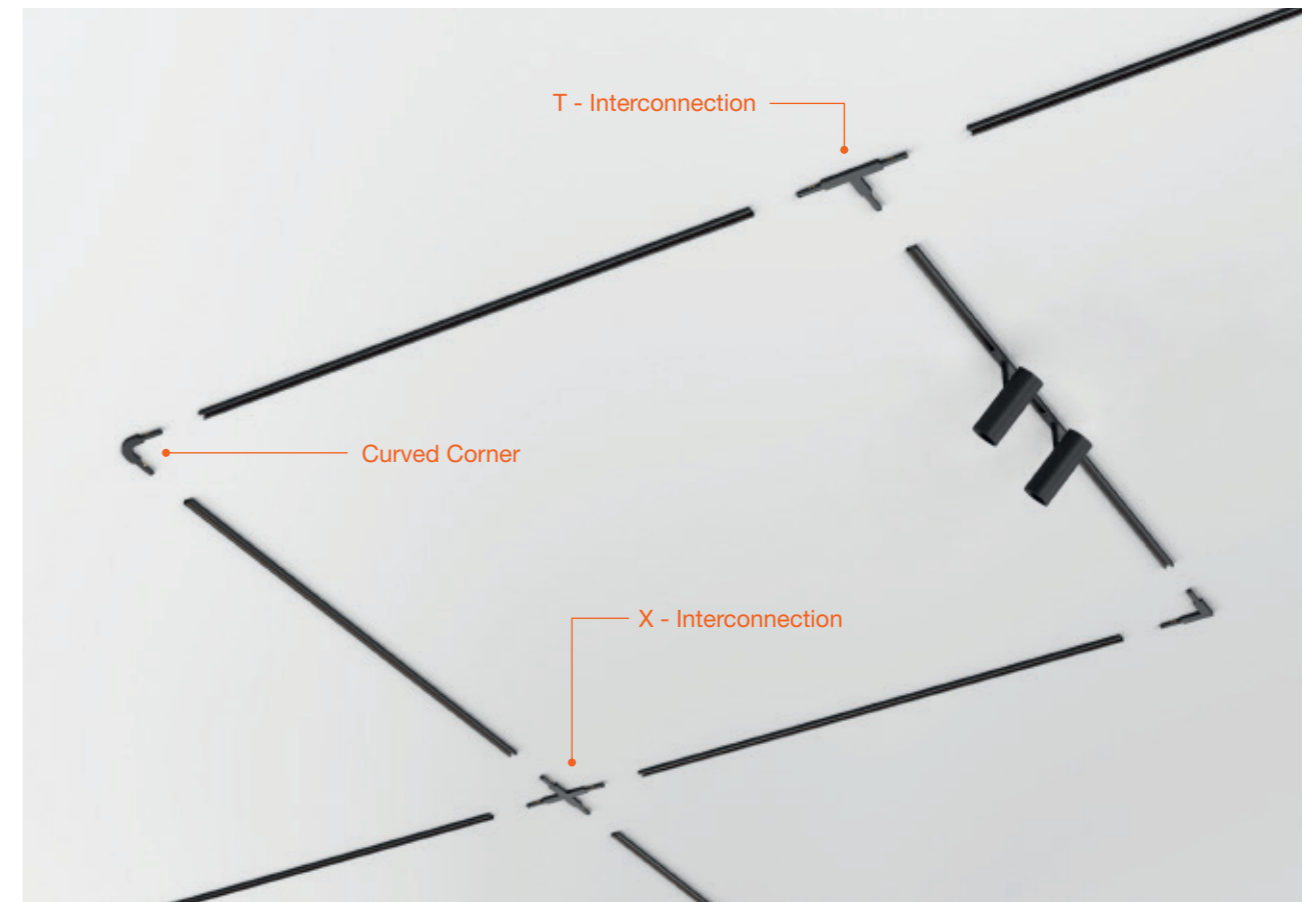

A minimal line only 17 mm wide and 7 mm high combined with the extreme miniaturization of the electronics bodies: this is how the Zero Track can seem like a recessed luminaire, merging with any architectural structure in a perfect integration.

Una línea mínima de solo 17 mm de ancho y 7 mm de alto combinada con la miniaturización extrema de los cuerpos electrónicos: así es como Zero Track puede parecer una luminaria empotrada, fusionándose con cualquier estructura arquitectónica en una integración perfecta.

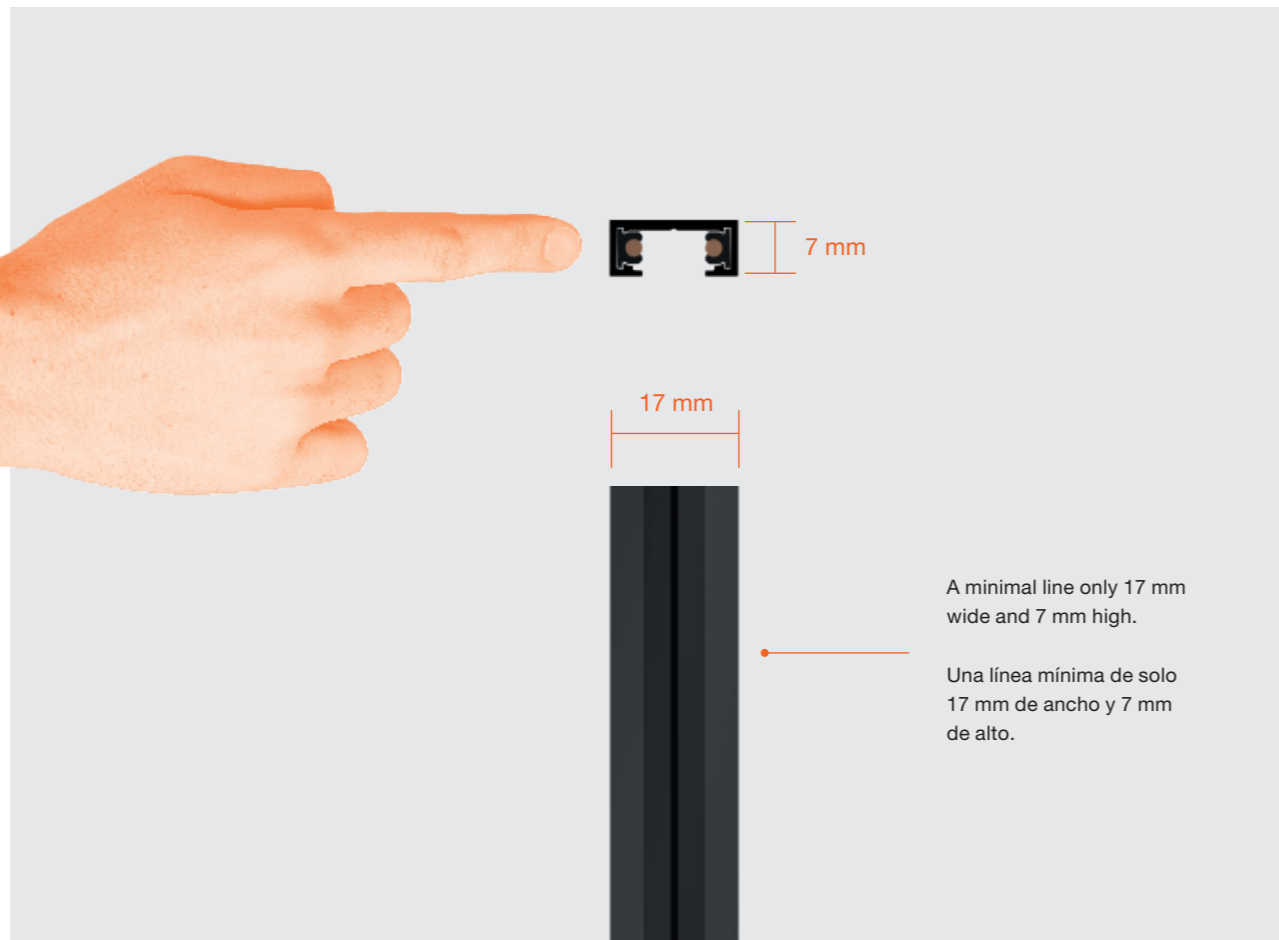

ZERO TRACK SYSTEM

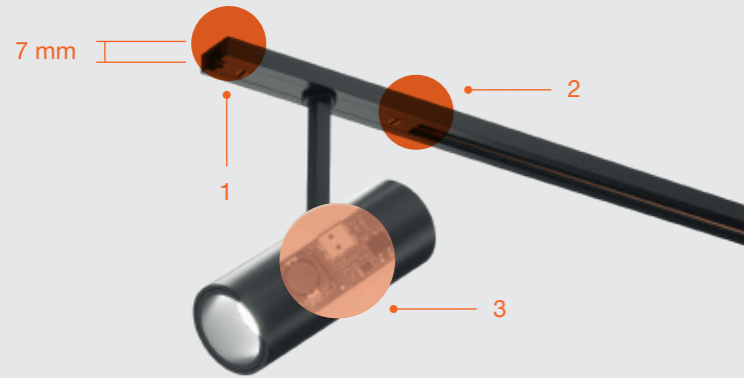

The ultimate level of miniaturization: track and spot dimensions are taken to the minimum size, with a pure design and the most radical control technology.

Máximo nivel de miniaturización: las dimensiones del carril y de los proyectores se llevan al tamaño mínimo, con un diseño puro y la tecnología de control más radical.

1 A minimal line only 7 mm high.
Una línea mínima de 7 mm de alto.

2 Maximum integration due to the extreme miniaturization of the electrical and mechanical devices.
Máxima integración debido a la extrema miniaturización del aparato eléctrico y mecánico.

3 Control electronics totally integrated into the projector head.
Electrónica de control totalmente integrada en la cabeza del proyector.

1 Traditional Engine
Motor Tradicional

2 Traditional Track
Track Tradicional

TRADITIONAL SYSTEM

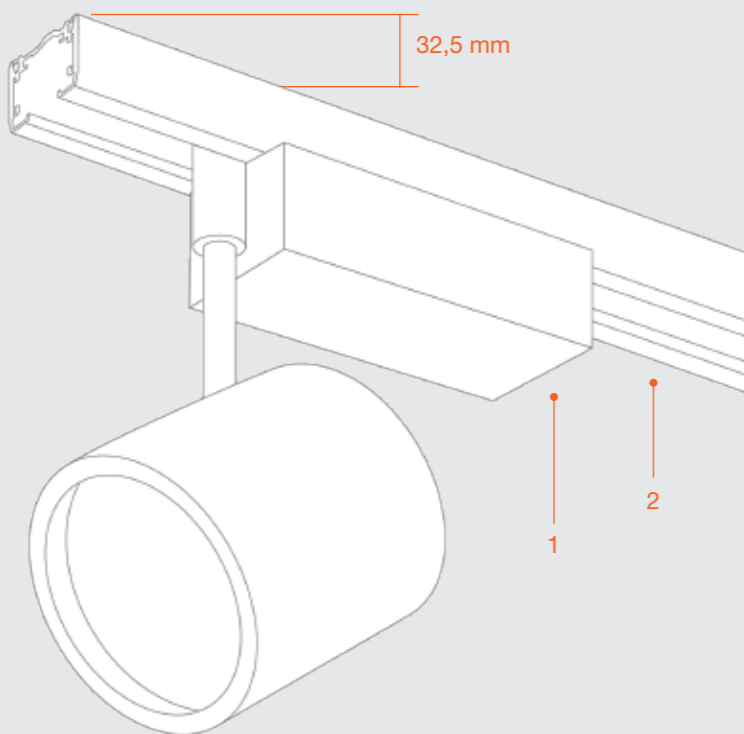

Surface power supply.
There are also versions of power supplies for remote installation equipped with various regulation protocols.

Fuente de alimentación de superficie. También existen versiones de fuentes de alimentación para instalación remota equipadas con diversos protocolos de regulación.





FIND ME



The Zero Track luminaire range culminates with the Find Me spots designed by Jorge Herrera. This innovative design embraces two different sizes, including the new Find Me 0, which brings the minimal designs of the successful Find Me collection now available for a track installation.

La gama de luminarias Zero Track culmina con los spots Find Me, diseñados por Jorge Herrera. Este innovador diseño abarca dos tamaños diferentes, incluyendo el nuevo Find Me 0, el cual brinda los diseños más minimalistas de la exitosa colección Find Me, ahora disponible para una instalación en carriles.

White, grey, black, bronze and brown



ATOM



With the exquisite design touch of Piero Lissoni, the Zero Track system offers Atom: a series of spotlights in two different sizes, perfect for an accent lighting. The Zero Track system provides the highest comfort level thanks to the deep position of the optic and the screening accessories included with each spot, completed by a round shape luminaire for a general lighting.

Con el excelente toque de diseño de Piero Lissoni, el sistema Zero Track ofrece Atom: una serie de focos en dos tamaños diferentes, perfectos para una iluminación de acento. El sistema Zero Track proporciona el máximo nivel de confort gracias a la posición profunda de la óptica y a los accesorios de apantallamiento incluidos en cada spot, completados por una luminaria de forma redonda para una iluminación más general.

White, grey, black, bronze and brown

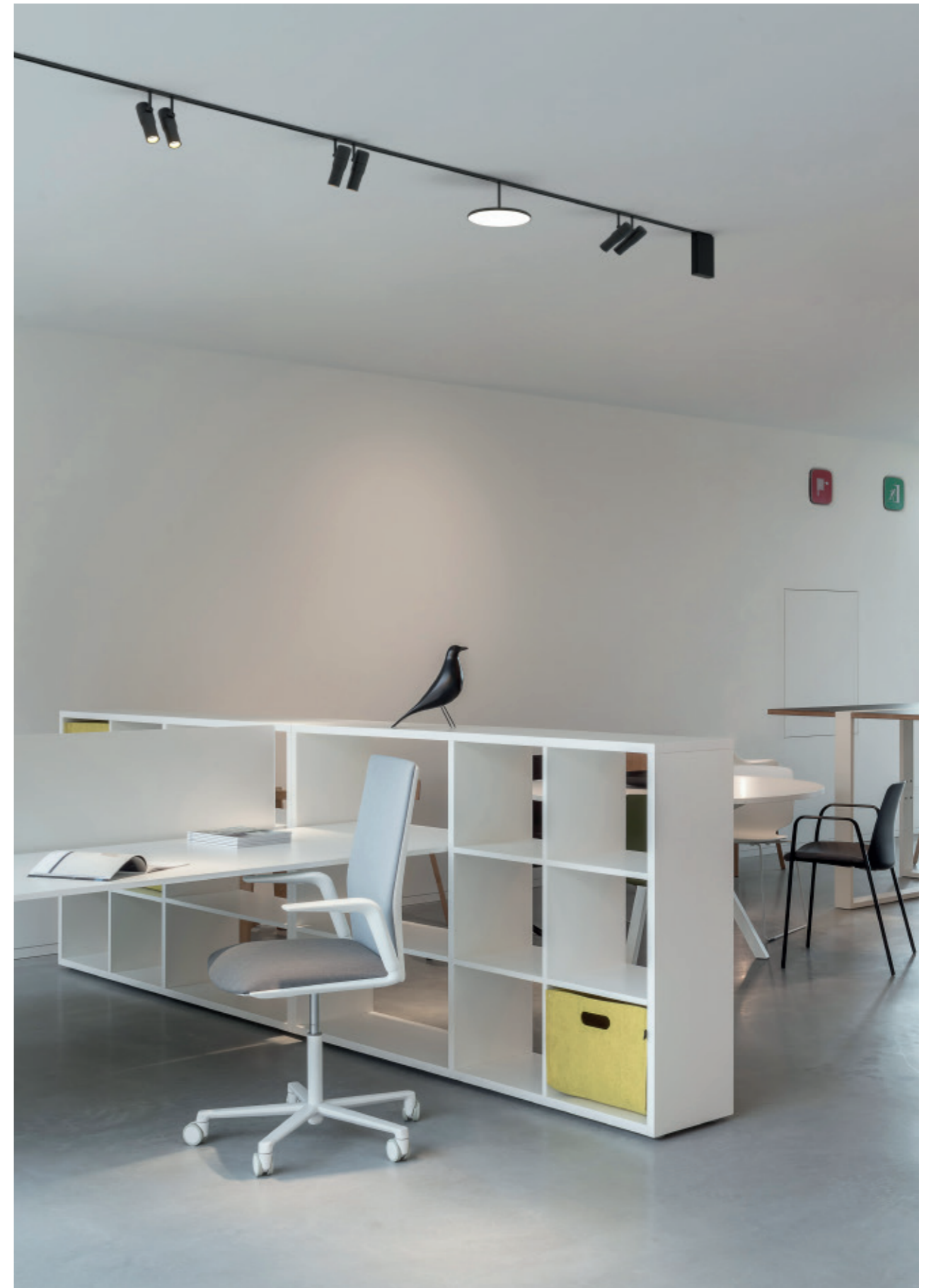

Different control options for dimming the Zero Track, all available for remote recessed or surface installation.

Diferentes opciones de control para la regulación de Zero Track, todas disponibles para una instalación empotrada o de superficie.

PUSH DIMMING

Control trough a simple pushbutton.

Control de la pista a través de un dispositivo de regulación.

DALI

Standard protocol for integration with any control system.

Protocolo estándar para la integración con cualquier sistema de control.

1-10V

Track control trough a dimmer device.

Control de la pista a través de un dispositivo de regulación.

CASAMBI

Track wireless control trough the FLOS Control[®], available iOS and Android devices.

Control inalámbrico de la pista a través de la aplicación FLOS Control[®], disponible para dispositivos iOS y Android.

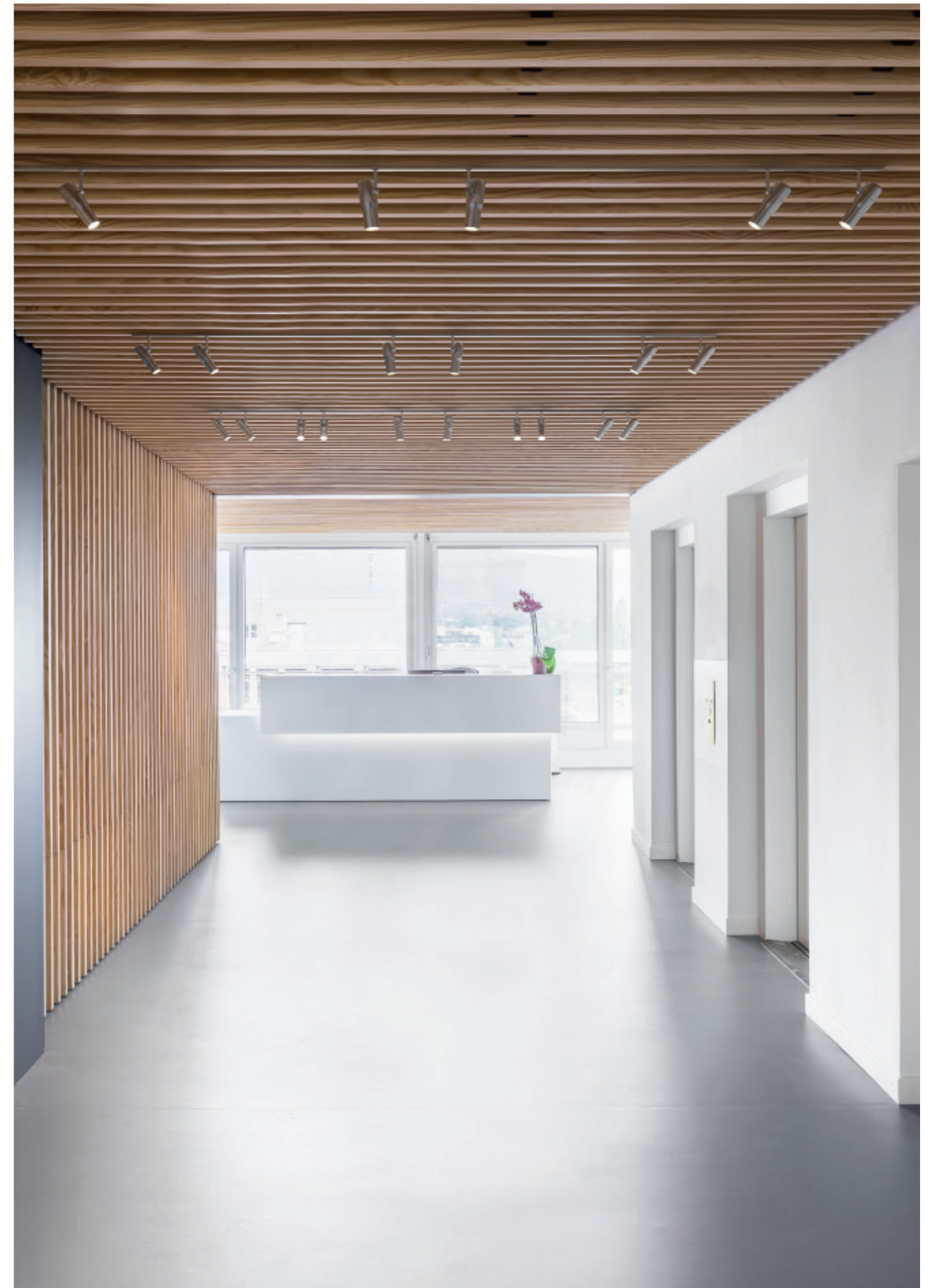
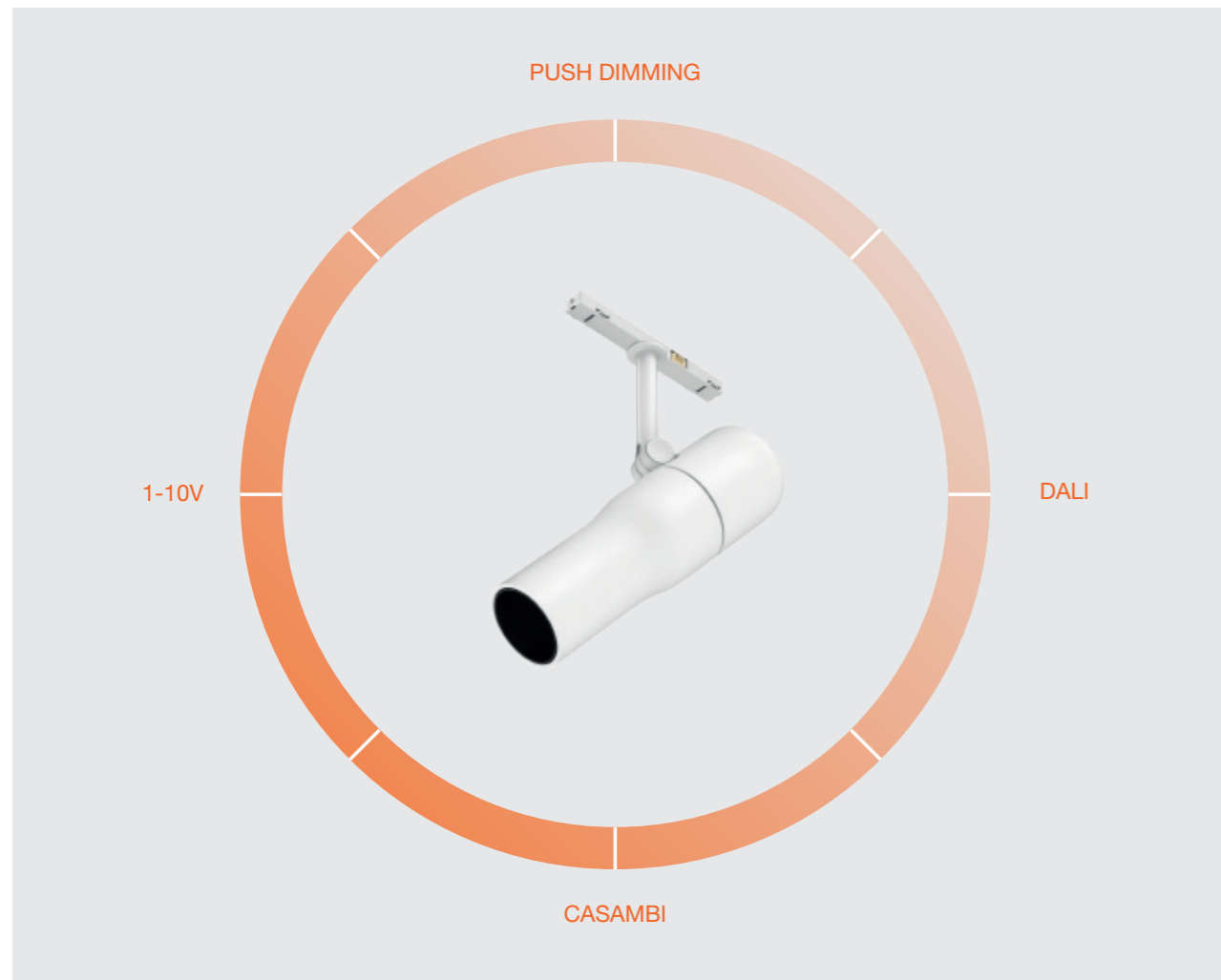

LIGHT MODULES

SURFACE PROFILES

FIND ME 0



POWER LED
3,5W

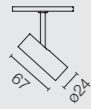

FIND ME 1



POWER LED
5,5W

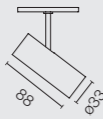

FIND ME 2



POWER LED
10,5W

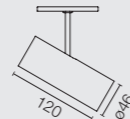

FIND ME 1
SUSPENSION



POWER LED
5,5W



ATOM 90



POWER LED
5,5W

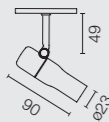

ATOM 120



POWER LED
8W

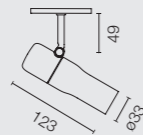

ATOM 200



POWER LED
10,5W

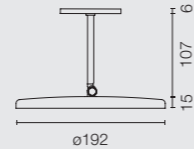

40 White
40 Blanco

06 Chrome
06 Cromo

14 Black
14 Negro

CZ Bronze
CZ Bronce

18 Deep brown
18 Deep brown

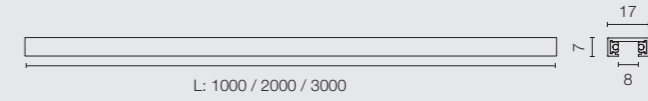

Spot



Medium



Flood

FLOS
CONTROL BY CASAMBI

