

**P**

**Paulmann**



**2022**

















--	--	--	--	--	--	--	--	--	--

Customer No. / N.º de cliente / N. cliente

We provide our products and services in accordance with our terms and conditions of payment and delivery. These are available on request or at [www.paulmann.com](http://www.paulmann.com)

Trabajamos sobre la base de nuestras condiciones de suministro y pago. Se las podemos enviar con mucho gusto previa solicitud o puede encontrarlas en [www.paulmann.com](http://www.paulmann.com).

Operiamo secondo le nostre condizioni di consegna e pagamento.  
Potete riceverle su richiesta o consultando il sito [www.paulmann.com](http://www.paulmann.com)

14	Living room	
60	Wall & Ceiling	
72	Panels	
88	Downlights	
144	Spotlights	
150	Rail Systems	
184	Wire Systems CorDuo	
212	LED Strips & Profiles	
268	Assistance	
280	Furniture	
304	Bathroom	
320	Outdoor	
386	Transformers	
392	Lamps	
438	Technical information, indexes	



## Realise your lighting ideas

Paulmann Licht GmbH, located in Springe in Lower Saxony (Germany), offers over 2500 innovative products; as one of the leading manufacturers in the light industry, we are able to share our expertise – from luminaires through luminaire systems to a complete bulb assortment with many speciality lamps.

Paulmann products appeal to your customers with feel-good lighting, trendy designs and high energy efficiency.

Sales offices and agencies in around 40 countries in Europe ensure that customers receive direct, local support.

## Da forma a tus ideas de iluminación

Paulmann Licht GmbH con sede en Springe, Baja Sajonia (Alemania), con sus más de 2500 productos innovadores, es uno de los proveedores líderes en el sector de luminarias y ofrece soluciones competentes para toda la gama de productos: desde luminarias y sistemas de iluminación hasta un surtido completo de lámparas con muchas especialidades.

Los productos Paulmann entusiasman a sus clientes por su luz agradable, diseño actual y alta eficiencia energética.

Gracias a las sucursales y representaciones en cerca de 40 países de Europa, los clientes reciben un asesoramiento individual y sin desplazamientos.

## Realizza i tuoi progetti di illuminazione

Con oltre 2500 prodotti innovativi, Paulmann Licht GmbH, che ha sede a Springe (Bassa Sassonia, Germania), è uno dei fornitori leader nel settore dell'illuminazione. Le sue competenze coprono l'intero assortimento: dai singoli apparecchi ai sistemi d'illuminazione fino a un assortimento completo di lampadine che vanta prodotti esclusivi.

I prodotti Paulmann soddisfano i clienti con la loro luce per il benessere, il design moderno e l'elevata efficienza energetica.

Grazie alle nostre filiali e rappresentanze in 40 Paesi europei, i clienti possono usufruire di un'assistenza individuale direttamente in loco.



EN High-performance logistics power  
 ES Potencia logística eficiente  
 IT Organizzazione logistica efficiente

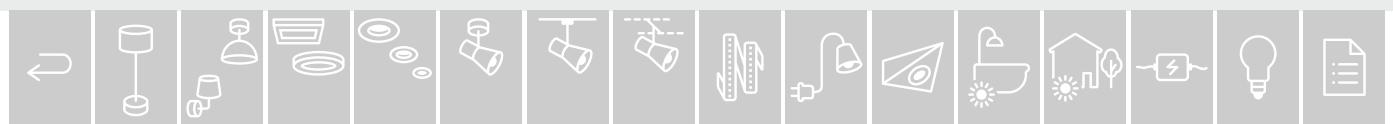



EN Strong point-of-sale presentation increases added value  
 ES Presencia fuerte en el punto de venta para un mayor valor añadido  
 IT La presentazione forte nel punto vendita aumenta la creazione di valore

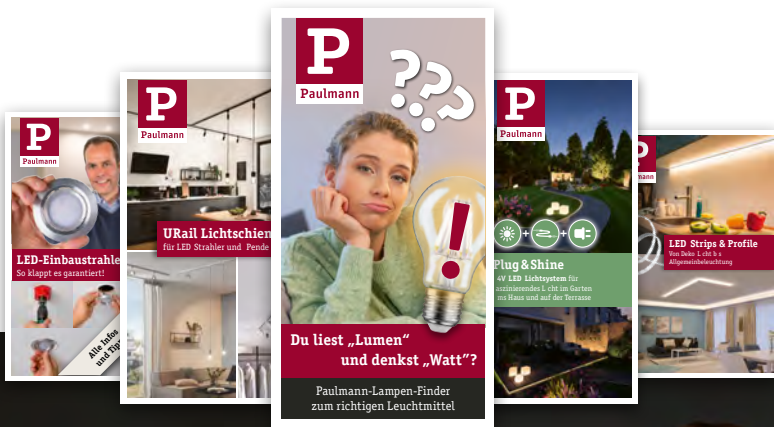

EN Unique, all-in-one content packages  
 ES Paquetes únicos de contenidos completos  
 IT Pacchetti di contenuti completi

**P Paulmann**  
**LICHTWELT**

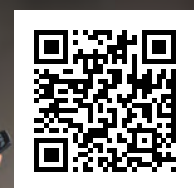

[www.youtube.com/PaulmannLicht](https://www.youtube.com/PaulmannLicht)

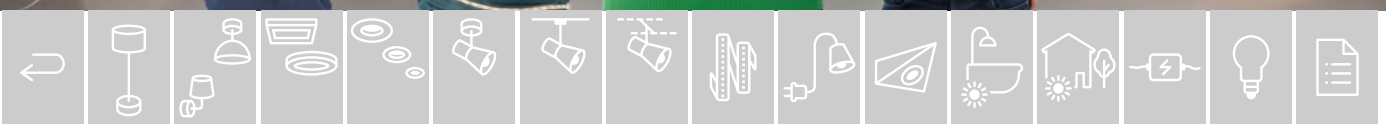

New



Panels  
Velora Rainbow  
□ = 78

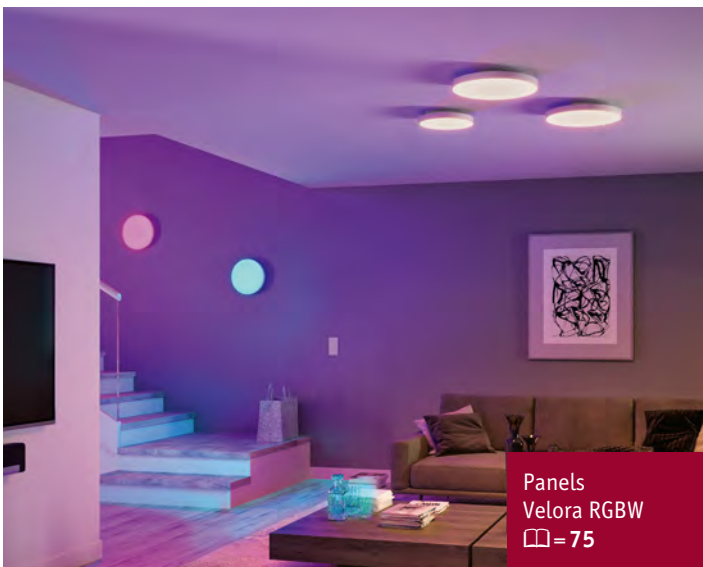

Panels  
Velora RGBW  
○ = 75

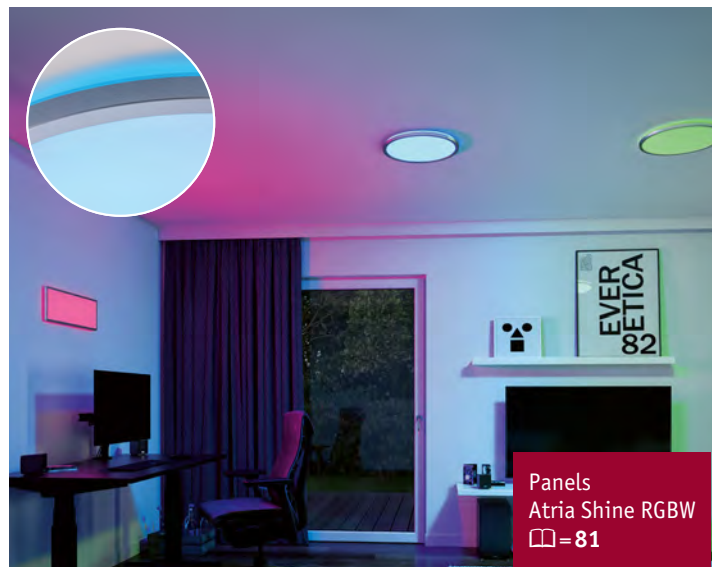

Panels  
Atria Shine RGBW  
○ = 81



Panels  
Atria Shine  
□ = 82

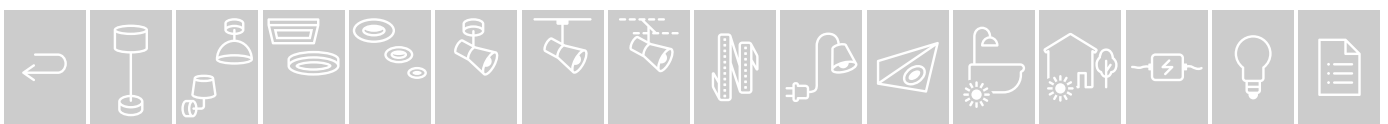



Downlights  
Gil  
☑=119



Living room  
Neordic Eldar  
☑=38

Lamps  
LED 1879 Edition Globe  
☑=413



Living room  
Neordic Hilla  
☑=20

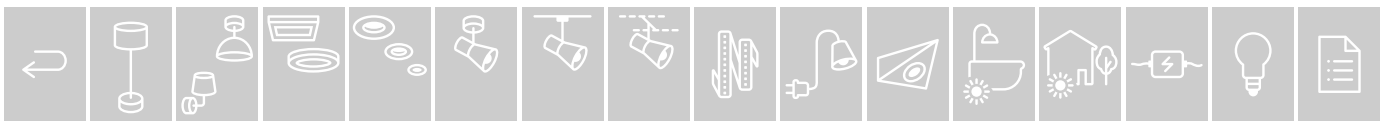

New



URail  
Single Spot-Base  
□=177

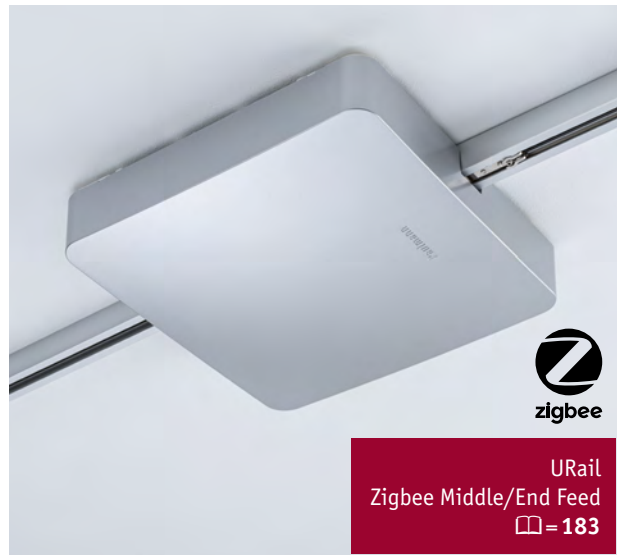

URail  
Zigbee Middle/End Feed  
□=183



URail  
Universal Pendulum Adapter  
□=182

Lamps  
LED Standard Filament 230 V  
□=411

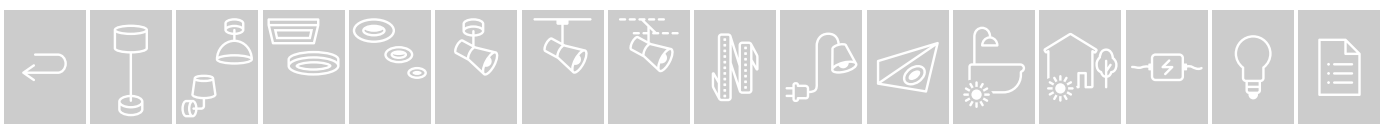





URail  
Spot Cone RGBW Zigbee  
□ = 162



Assistance  
Renan  
□ = 277



Profiles  
Square Profil  
□ = 258

Profiles  
Base Profil  
□ = 259



New



Wall/Ceiling  
Rainbow  
☐=61



Outdoor  
Solar Eileen  
☐=371

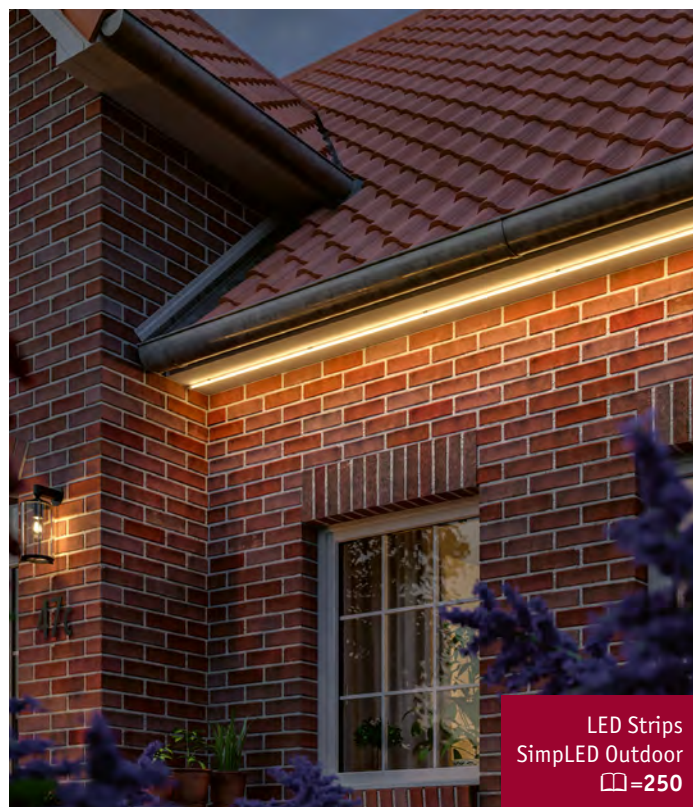

LED Strips  
SimpLED Outdoor  
☐=250

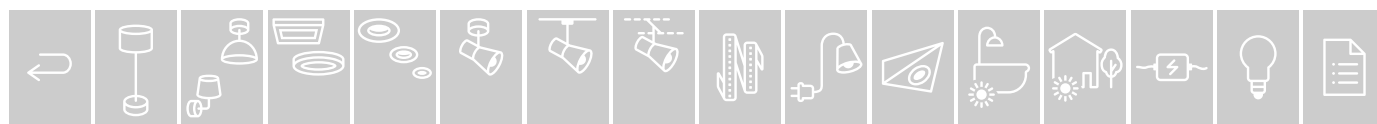



**Park + Light**

Outdoor  
Park + Light  
☐ = 346

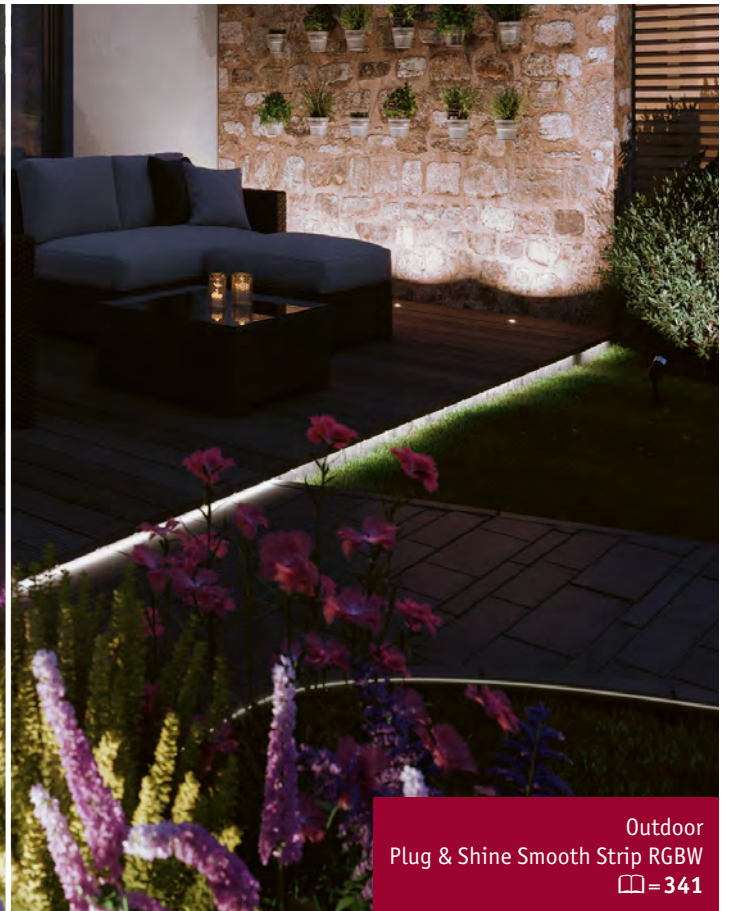
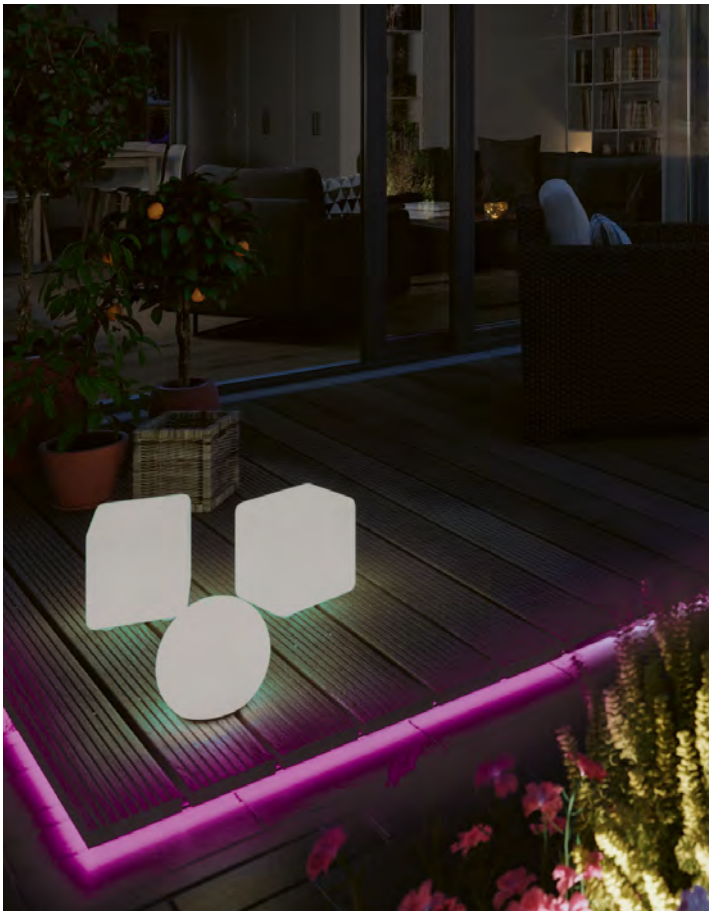

Outdoor  
Plug & Shine Smooth Strip RGBW  
☐ = 341

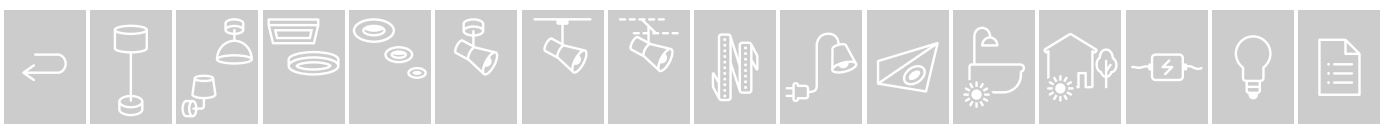

# Smart Home



EN Lamps ES Lámparas IT Lampadine

## Smart Home

Create a wonderful light ambiance in any room or in the garden with our large selection of smart lamps and luminaires. Eye-friendly warm white, adjustable tunable white or colourful RGBW, bright or subdued – our smart products offer the perfect light for any application. Create individual lighting scenarios for specific spaces or rooms for any time use. You can use our clever controllers to include your existing installations in your smart scenarios. Depending on the available technology, everything is controlled via app, voice or remote control.

La amplia selección de lámparas y luminarias inteligentes crea una experiencia de luz evocadora en cualquier estancia y también en el jardín. Ya sea un acogedor blanco cálido, un blanco ajustable con posibilidad de regulación o un RGBW de colores, ya sea claro o atenuado: nuestros productos inteligentes tienen la luz adecuada para cada aplicación. Las escenas de luz se pueden crear y activar para zonas o estancias de manera individual y con total comodidad. Incluso las instalaciones existentes se pueden controlar de forma inteligente con nuestros ingeniosos controladores. Según la tecnología, el control se realiza fácilmente mediante aplicación, por voz o con control remoto.

L'ampio assortimento di lampadine e apparecchi smart contribuisce a creare una suggestiva atmosfera luminosa in tutti gli ambienti e in giardino. Che si tratti di un bianco caldo confortevole, Tunable White regolabile, RGBW variopinto, luce luminosa o regolabile: i nostri prodotti smart hanno la soluzione giusta per ogni applicazione. Gli scenari luminosi si possono creare individualmente per ambienti o stanze e richiamare comodamente. Anche le installazioni esistenti sono comandabili con il nostro smart Controller. Il comando avviene, in base alla tecnologia, tramite app, comando vocale o telecomando.



URail



Plug & Shine

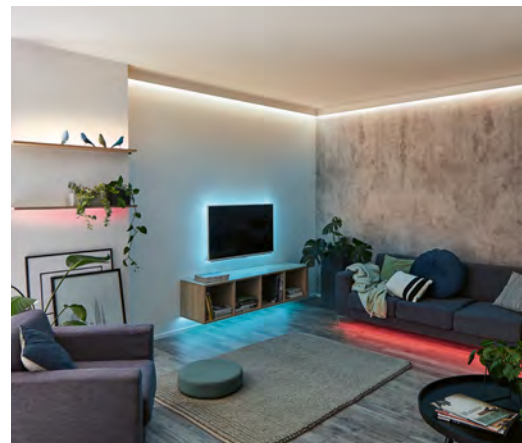

MaxLED Strips

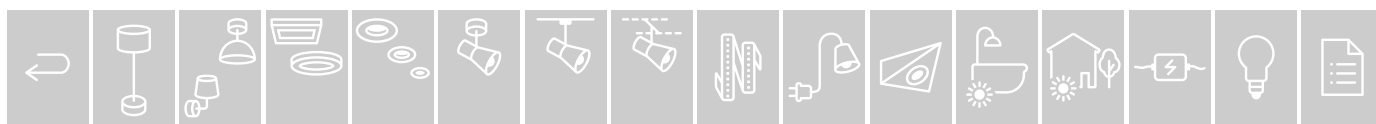

# Bluetooth®

Step right in to the smart universe without having to buy additional accessories and find out how easy it is to adjust the light ambiance of a room simply via app or remote control. The Paulmann app is free to download.

Sumérgase en el mundo inteligente de forma sencilla y sin necesidad de más accesorios y adapte el ambiente luminoso de una estancia individualmente por control remoto o mediante aplicación. La aplicación Paulmann está disponible para la descarga gratuita.

Ci si può immergere facilmente nel mondo smart senza altri accessori e adattare l'atmosfera luminosa di un ambiente in modo personalizzato con il telecomando o l'app. L'app Paulmann è disponibile gratuitamente per il download.



Living room ☐=49



Wire Systems ☐=186



LED Strips & Profiles ☐=218, 229, 242-243

# Zigbee

Conveniently network lighting and other Smart Home components in your home and garden. Our Zigbee lamps, luminaires and controllers can be used with any Smart Home control panel with a Zigbee interface, or can be controlled directly via remote control. Control via app while you are not at home or the programming of routines may also be possible depending on the system used.

Interconecte cómodamente la luz y otros componentes de Smart Home en la casa y en el jardín. Nuestras lámparas, luminarias y controllers Zigbee se pueden utilizar con centrales de Smart Home que dispongan de una interfaz Zigbee u operar directamente con un mando a distancia. En función del sistema utilizado, también es posible el control remoto desde fuera de casa o la incorporación en rutinas.

È possibile collegare in rete con la massima comodità la luce e altri componenti Smart Home sia in casa che in giardino. Le nostre lampadine, lampade e i nostri controller Zigbee possono essere utilizzati con qualsiasi unità centrale Smart Home dotata di un'interfaccia Zigbee oppure controllati direttamente con il telecomando. A seconda del sistema utilizzato, sono possibili anche il comando da fuori casa o l'integrazione nelle routine.

## Ready for

- Amazon Echo Smart Speaker with Zigbee

- Philips Hue Bridge 2 (excl.: Hue Entertainment)

- Paulmann Gent Remote Control 500.67

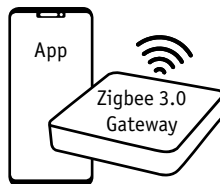
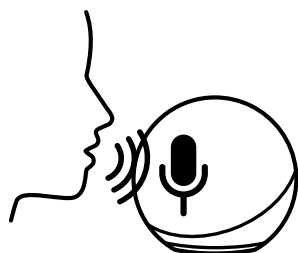

Living room ☐=50



Panels ☐=75, 79



Downlights ☐=103, 118, 128, 132



Rail Systems ☐=162, 183



LED Strips & Profiles ☐=229, 242, 244



Outdoor ☐=323, 327, 330-331, 338, 341, 343, 349, 359, 368, 370, 379



Lamps ☐=430-431





- ▶ For direct control of Paulmann Bluetooth products
- ▶ Enables control of up to six light groups
- ▶ Para el control directo de los productos Bluetooth de Paulmann
- ▶ Permite controlar hasta seis grupos de luces
- ▶ Per il comando diretto dei prodotti Bluetooth di Paulmann
- ▶ Consente di gestire un massimo di sei gruppi di apparecchi luminosi



#### Remote Control Boss



2xAAA/1,5V (Micro)



↑18 ↔48 ↗110 mm

EAN 4000870 500019

**500.01**

 Black  Plastic

 Negro  Plástico

 Nero  Plastica



- ▶ Smart retrofits for existing installations
- ▶ Simply install between 230 V power outlet and luminaire or device
- ▶ Controllable via Paulmann app (Bluetooth 4.0) or Boss remote control
- ▶ Conversión posterior de instalaciones existentes en sistemas inteligentes
- ▶ Montaje sencillo entre la conexión de 230 V y la luminaria o el dispositivo
- ▶ Posibilidad de control mediante aplicación Paulmann, vía Bluetooth 4.0 o con control remoto Boss
- ▶ Trasformazione smart di installazioni esistenti a posteriori
- ▶ Basta effettuare il montaggio tra il collegamento da 230 V e l'apparecchio o il dispositivo
- ▶ Comandabile via app Paulmann tramite Bluetooth 4.0 o telecomando Boss

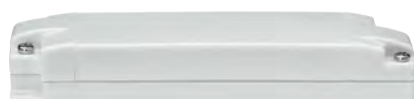

#### Master Switch

max. 500 W



220-240 V



Ω max. 500 W, C max. 75 W, I max. 75 W



↑26 ↔47 ↗136 mm

EAN 4000870 500170

**500.17**

 White  Plastic

 Blanco  Plástico

 Bianco  Plastica



#### Master Switch/Dimm

max. 300 W



220-240 V



Ω max. 300 W, I max. 100 W



↑26 ↔47 ↗136 mm

EAN 4000870 500187

**500.18**

 White  Plastic

 Blanco  Plástico

 Bianco  Plastica

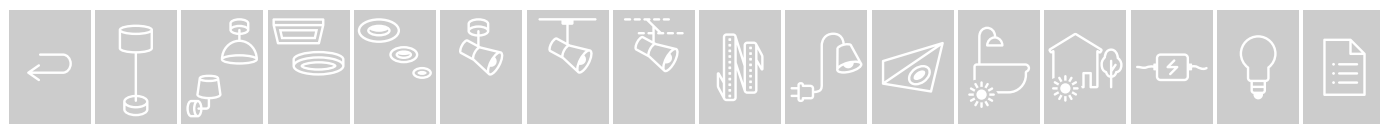



- ▶ Direct control of ZigBee products
- ▶ Select, dim or switch white or colour with the push of a button
- ▶ Products can be controlled individually or in up to three groups.

- ▶ Para el control directo de productos inteligentes ZigBee
- ▶ Ajuste de tonos de blanco o de color, regulación y conmutación pulsando simplemente un botón
- ▶ Los productos se pueden controlar individualmente o en un máximo de tres grupos

- ▶ Per il comando diretto di prodotti smart Zigbee
- ▶ Basta impostare le tonalità di bianco o di colore, regolarle e commutarle premendo un pulsante
- ▶ I prodotti possono essere controllati singolarmente o in gruppi.



#### Gent Remote Control

2xAAA/1,5V (Micro)  
 ⌀18 ⇄55 ↗138 mm  
 EAN 4000870 500675

**500.67**

- 🔧 Black 📦 Plastic
- 🔧 Negro 📦 Plástico
- 🔧 Nero 📦 Plastica



- ▶ ZigBee controller for a smart retrofit of a wide variety of devices by many manufacturers
- ▶ Simply install between 230 V power outlet and luminaire or device

- ▶ Controller ZigBee para el equipamiento inteligente posterior de los dispositivos más diversos de diferentes fabricantes
- ▶ Montaje sencillo entre la conexión de 230 V y la luminaria o el dispositivo

- ▶ Controller ZigBee per un retrofit intelligente di dispositivi di diversi fabbricanti
- ▶ Basta effettuare il montaggio tra il collegamento da 230 V e l'apparecchio o il dispositivo



#### Cephei Switch

max. 1.000 W  
 230 V  
 $\Omega$  max. 1.000 W, C max. 75 W, I max. 75 W  
 ⌀28 ⇄95 ↗38 mm  
 EAN 4000870 500439

**500.43**

- 🔧 White/Grey 📦 Plastic
- 🔧 Blanco/Gris 📦 Plástico
- 🔧 Bianco/Grigio 📦 Plastica



#### Cephei Switch/ Dimm

max. 400 W  
 230 V  
 $\Omega$  max. 400 W, C max. 150 W,  
 ⌀53 ⇄163 ↗60 mm  
 EAN 4000870 500446

**500.44**

- 🔧 White/Grey 📦 Plastic
- 🔧 Blanco/Gris 📦 Plástico
- 🔧 Bianco/Grigio 📦 Plastica

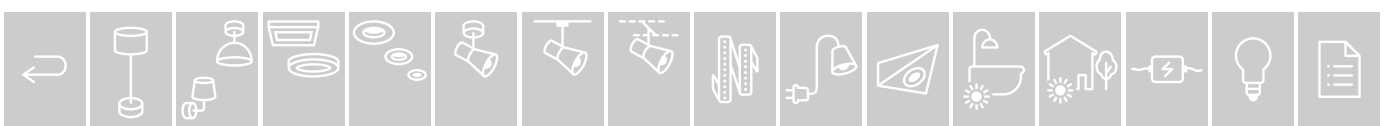

# Living room

18 Neordic

46 Puric

55 Classic

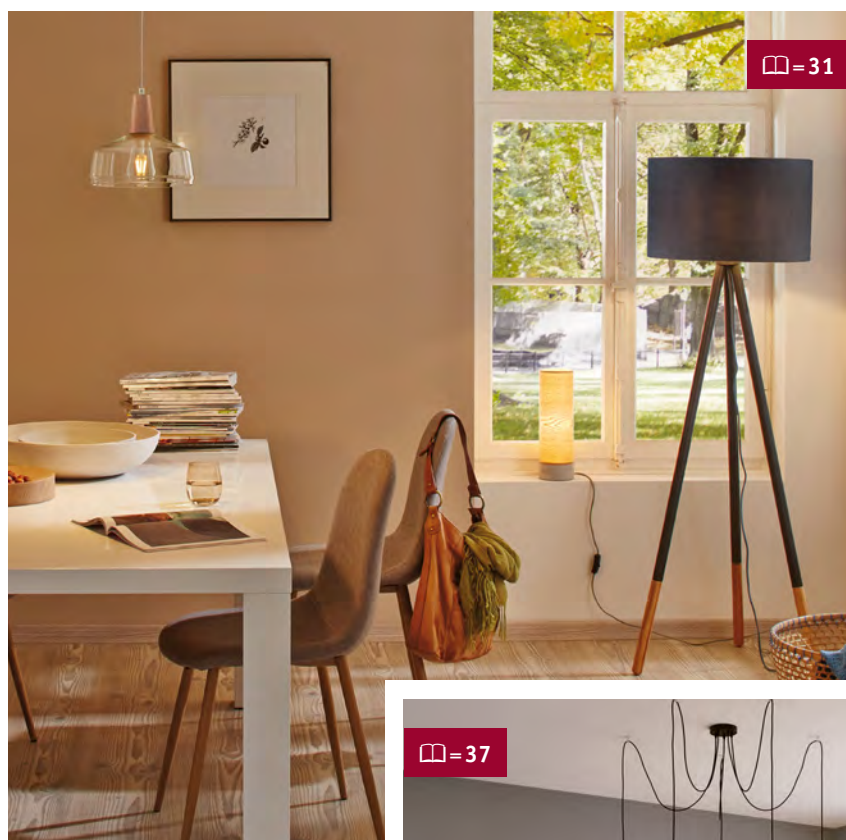

📖=31

📖=38

## Neordic

EN Scandinavian, modern and natural luminaires with real wood, real concrete and real marble

ES Luminarias escandinavas modernas y naturales de madera auténtica, hormigón auténtico y mármol auténtico

IT Lampade in stile scandinavo, moderne e naturali in vero legno, vero calcestruzzo e vero marmo

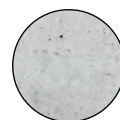

📖=37

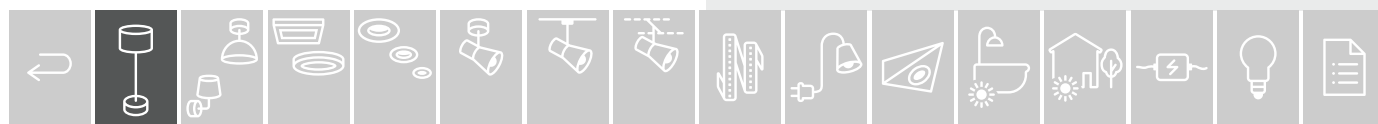





☑ = 48

# Puric

EN Luminaires in a minimalist design with modern technology and fascinating lighting effects  
 ES Luminarias con un diseño minimalista y una tecnología moderna con fascinantes efectos de luz  
 IT Apparecchi dal design minimale con una tecnologia moderna e con effetti di luce affascinanti



☑ = 50

# Classic

EN Luminaires with a classic, timeless design  
 ES Luminarias de diseño clásico e intemporal  
 IT Apparecchi dal design classico e intramontabile



☑ = 55





795.21 □ = 18



797.60 □ = 19



797.64 □ = 20



797.68 □ = 21



797.48 □ = 23



797.30 □ = 24



797.56 □ = 24



797.43 □ = 25



797.24 □ = 26



797.39 □ = 27

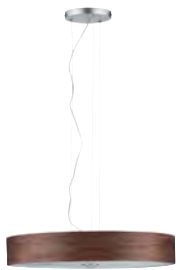

796.86 □ = 28



796.64 □ = 29



796.50 □ = 29



796.40 □ = 29



796.34 □ = 30



796.46 □ = 30



796.33 □ = 31



796.51 □ = 32



796.29 □ = 33



796.44 □ = 33



796.58 □ = 34



796.90 □ = 35



796.82 □ = 35



503.82 □ = 36



503.89 □ = 37





503.86 □ = 38



503.85 □ = 38



796.09 □ = 40



796.12 □ = 40



797.51 □ = 40



796.15 □ = 41



503.88 □ = 43



796.21 □ = 43



796.63 □ = 44



796.17 □ = 44



796.22 □ = 44



796.24 □ = 45



796.65 □ = 45



797.17 □ = 47

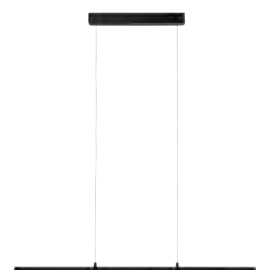

796.93 □ = 49



798.15 □ = 50



797.21 □ = 51



797.69 □ = 53



709.29 □ = 54



709.28 □ = 55



709.25 □ = 55



709.23 □ = 57



770.58 □ = 58



770.56 □ = 59



770.57 □ = 59







**1 Kine**  
 max. 20 W, E27  
 230 V  
 ⚡ 150 cm ø100 mm  
 EAN 4000870 797570  
**797.57**

🔗 Black Metal  
 🔗 Negro Metal  
 🔗 Nero Metallo

**2 Malja**  
 max. 20 W, E27  
 230 V  
 ⚡ 125 ø100 mm  
 EAN 4000870 797600  
**797.60**

🔗 Black Metal  
 🔗 Negro Metal  
 🔗 Nero Metallo

**3 Skogen**  
 max. 3×20 W, E27  
 230 V  
 ⚡ 145 ø240 mm  
 EAN 4000870 797617  
**797.61**

🔗 Black Metal  
 🔗 Negro Metal  
 🔗 Nero Metallo

**4 Aik**  
 max. 20 W, E27  
 230 V  
 ⚡ 120 ø45 ⇄45  
 ⚡ 150 mm  
 EAN 4000870 797624  
**797.62**

🔗 Black Metal  
 🔗 Negro Metal  
 🔗 Nero Metallo

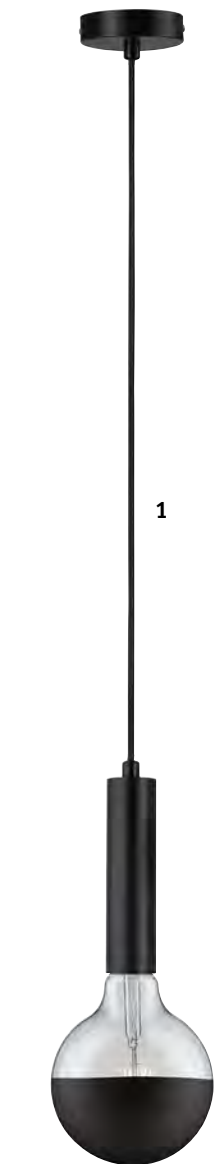

**5 Haldor**  
 max. 20 W, E27  
 230 V  
 ⚡ 95 ø120 mm  
 EAN 4000870 797587  
**797.58**

🔗 Black Metal  
 🔗 Negro Metal  
 🔗 Nero Metallo

**6 Haldor**  
 max. 20 W, E27  
 230 V  
 ⚡ 95 ø120 mm  
 EAN 4000870 797594  
**797.59**

🔗 Brushed iron Metal  
 🔗 Hierro mateado Metal  
 🔗 Ferro spazzolato Metallo

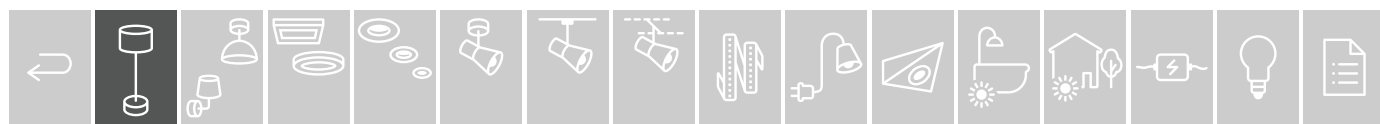



Perfect match

☑ = 409-411  
432

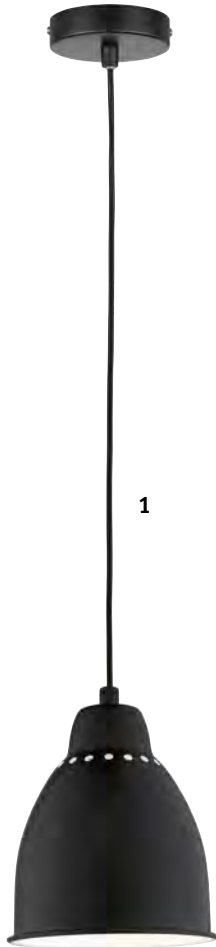

1

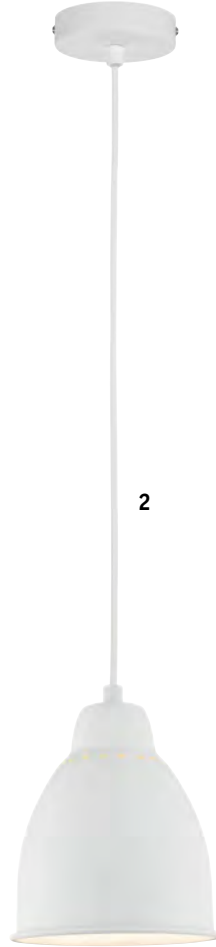

2

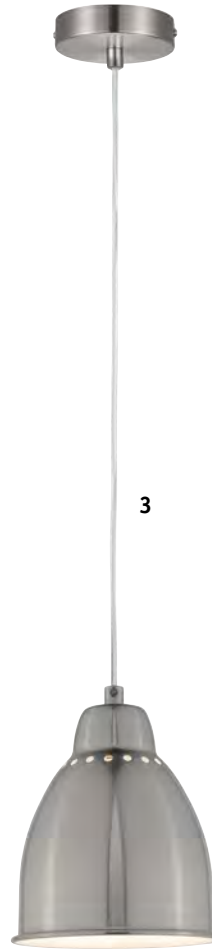

3

**1 Hilla**

max. 40W, E27  
230V  
⌀180 cm ø145 mm  
EAN 4000870 797631

**797.63** new

- Black Metal
- Negro Metal
- Nero Metallo



**2 Hilla**

max. 40W, E27  
230V  
⌀180 cm ø145 mm  
EAN 4000870 797648

**797.64** new

- White Metal
- Blanco Metal
- Bianco Metallo



**3 Hilla**

max. 40W, E27  
230V  
⌀180 cm ø145 mm  
EAN 4000870 797655

**797.65** new

- Brushed iron Metal
- Hierro mateado Metal
- Ferro spazzolato Metallo





**1 Lavea**

max. 15 W, E27  
230 V  
180 cm ø100 mm  
EAN 4000870 797662

**797.66** **new**

- Black Metal
- Negro Metal
- Nero Metallo



**2 Lavea**

max. 15 W, E27  
230 V  
180 cm ø100 mm  
EAN 4000870 797679

**797.67** **new**

- White Metal
- Blanco Metal
- Bianco Metallo



**3 Lavea**

max. 15 W, E27  
230 V  
180 cm ø100 mm  
EAN 4000870 797686

**797.68** **new**

- Brushed iron Metal
- Hierro mateado Metal
- Ferro spazzolato Metallo



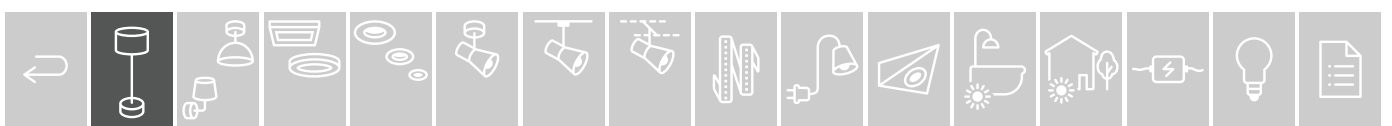





**1 Tasja**

max. 20 W, E27  
230 V  
↑4,35-110 cm  
↔300 ↗120 mm  
EAN 4000870 797488

- 797.48**
- 🔧 Black/Copper 🏠 Metal
  - 🔧 Negro/Cobre 🏠 Metal
  - 🔧 Nero/Rame 🏠 Metallo



**2 Fanja**

max. 20 W, GU10  
230 V  
↑38-110 cm ∅115 mm  
EAN 4000870 797495

- 797.49**
- 🔧 Black/Copper 🏠 Metal
  - 🔧 Negro/Cobre 🏠 Metal
  - 🔧 Nero/Rame 🏠 Metallo

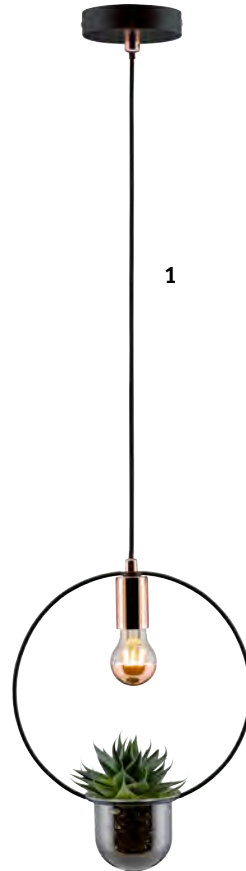
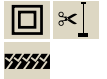

**3 Fanja**

max. 20 W, GU10  
230 V  
↑625 ↔370 ↗180 mm  
EAN 4000870 797464

- 797.46**
- 🔧 Black/Copper 🏠 Metal
  - 🔧 Negro/Cobre 🏠 Metal
  - 🔧 Nero/Rame 🏠 Metallo

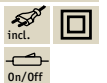



**Dilja**  
 max. 20 W, E27  
 230 V  
 ⌀85 ↔85 ⌀85 mm  
 EAN 4000870 797280  
**797.28**  
 ✎ Brushed brass **Metal**  
 ✎ Latón mateado **Metal**  
 ✎ Ottone spazzolato **Metallo**



**Kura**  
 max. 20 W, E27  
 230 V  
 ⌀85 ↔85 ⌀85 mm  
 EAN 4000870 797303  
**797.30**  
 ✎ Brushed iron **Metal**  
 ✎ Hierro mateado **Metal**  
 ✎ Ferro spazzolato **Metallo**



**1 Stian**  
 max. 20 W, E27  
 230 V  
 ⌀150 cm ⌀155 mm  
 EAN 4000870 797556  
**797.55**  
 ✎ Brushed brass **Metal**  
 ✎ Latón mateado **Metal**  
 ✎ Ottone spazzolato **Metallo**



**2 Kine**  
 max. 20 W, E27  
 230 V  
 ⌀150 cm ⌀100 mm  
 EAN 4000870 797563  
**797.56**  
 ✎ Brushed brass **Metal**  
 ✎ Latón mateado **Metal**  
 ✎ Ottone spazzolato **Metallo**





**1 Linja**  
 max. 20W, E27  
 230V  
 ⚙️ 110 cm ø165 mm  
 EAN 4000870 797433  
**797.43**  
 🌀 Smoke glass/Brushed brass  
 🏠 Mirror/Glass/Metal  
 🌀 Vidrio ahumado/Latón mateado  
 🏠 Espejo/Cristal/Metal  
 🌀 Vetro opaco/Ottone spazzolato  
 🏠 Specchio/Vetro/Metallo

**2 Esben**  
 max. 20W, E27  
 230V  
 ⚙️ 110 cm ø200 mm  
 EAN 4000870 797259  
**797.25**  
 🌀 Clear/Brushed brass  
 🏠 Glass/Metal  
 🌀 Transparente/Latón mateado  
 🏠 Cristal/Metal  
 🌀 Trasparente/Ottone spazzolato  
 🏠 Vetro/Metallo

**3 Menja**  
 max. 20W, E27  
 230V  
 ⚙️ 110 cm ø200 mm  
 EAN 4000870 797334  
**797.33**  
 🌀 White/Brushed brass  
 🏠 Glass/Metal  
 🌀 Blanco/Latón mateado  
 🏠 Cristal/Metal  
 🌀 Bianco/Ottone spazzolato  
 🏠 Vetro/Metallo



**Vala**  
 max. 20W, E27  
 230V  
 ⚙️ 120 ø110 mm  
 EAN 4000870 797426  
**797.42**  
 🌀 Brushed brass/Marble  
 🏠 Metal/Marble  
 🌀 Latón mateado/Mármol  
 🏠 Metal/Mármol  
 🌀 Ottone spazzolato/Marmo  
 🏠 Metallo/Marmo





Perfect match  
 □ = 409-412  
 427



**Narve**

max. 60 W, E27

230 V

↑ 1.540 ⇄ 525

∅ 535 mm

EAN 4000870 797242

**797.24**

👉 Beige/Black 📏 Fabric/Metal

👉 Beige/Negro 📏 Tela/Metal

👉 Beige/Nero 📏 Tessuto/Metallo





# Real cork / Smoke glass



**Iben**  
max. 20W, E27  
230V  
∅255 ∅190 mm  
EAN 4000870 797365  
**797.36**  
☞ Smoke glass ☒ Glass/Cork  
☞ Vidrio ahumado  
☒ Cristal/Corcho  
☞ Vetro opaco ☒ Vetro/Cork

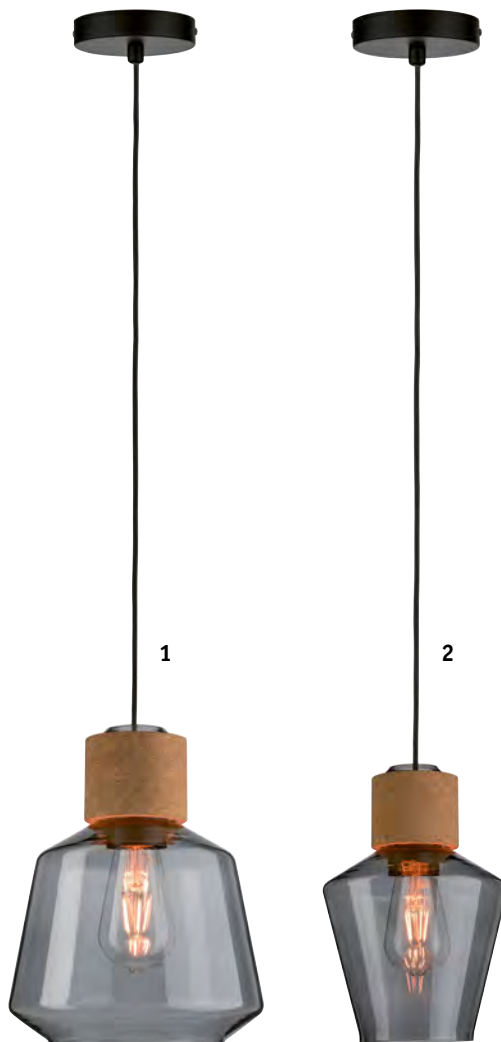

**1 Elia**  
max. 20W, E27  
230V  
∅110 cm ∅208 mm  
EAN 4000870 797396  
**797.39**  
☞ Smoke glass/Cork/Black  
☒ Glass/Cork/Metal  
☞ Vidrio ahumado/Corcho/Negro  
☒ Cristal/Corcho/Metal  
☞ Vetro opaco/Cork/Nero  
☒ Vetro/Cork/Metallo

**2 Edla**  
max. 20W, E27  
230V  
∅125 cm ∅180 mm  
EAN 4000870 797402  
**797.40**  
☞ Smoke glass/Cork/Black  
☒ Glass/Cork/Metal  
☞ Vidrio ahumado/Corcho/Negro  
☒ Cristal/Corcho/Metal  
☞ Vetro opaco/Cork/Nero  
☒ Vetro/Cork/Metallo



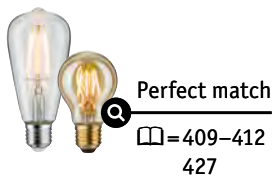

1



2



**1 Liska**

max. 3x20 W, E27  
230 V  
±150 ø450 mm  
EAN 4000870 796870  
**796.87**



- 🔗 Dark wood 📦 Wood/Metal
- 🔗 Madera oscura
- 📦 Madera/Metal
- 🔗 Legno scuro 📦 Legno/Metallo

**2 Liska**

max. 3x20 W, E27  
230 V  
±10,2-132 cm  
ø600 mm  
EAN 4000870 796863  
**796.86**



- 🔗 Dark wood/Chrome matt
- 📦 Wood/Metal
- 🔗 Madera oscura/Cromo mate
- 📦 Madera/Metal
- 🔗 Legno scuro/Cromo opaco
- 📦 Legno/Metallo



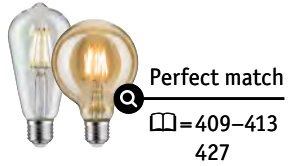

1

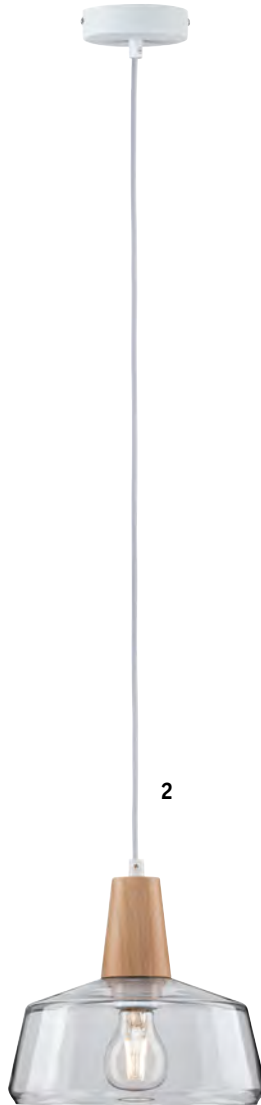

2



3



4



5

### 1 Liska

max. 3×20W, E27  
230V  
±150 ø450 mm  
EAN 4000870 796504



**796.50**

🌳 Wood 🏠 Wood/Metal  
🌳 Madera 🏠 Madera/Metal  
🌳 Legno 🏠 Legno/Metallo

### 2 Yva

max. 20W, E27  
230V  
±23,2-110 cm  
ø240 mm  
EAN 4000870 797440



**797.44**

🌳 Wood/Clear 🏠 Wood/Glass  
🌳 Madera/Transparente  
🏠 Madera/Cristal  
🌳 Legno/Trasparente  
🏠 Legno/Vetro

### 3 Ylvie

max. 20W, E27  
230V  
±25,7-110 cm ø145 mm  
EAN 4000870 797457



**797.45**

🌳 Wood/Clear 🏠 Wood/Glass  
🌳 Madera/Transparente  
🏠 Madera/Cristal  
🌳 Legno/Trasparente  
🏠 Legno/Vetro

### 4 Skadi

max. 20W, E14  
230V  
±350 ø110 mm  
EAN 4000870 796641



**796.64**

🌳 Wood/Grey 🏠 Wood/Concrete  
🌳 Madera/Gris  
🏠 Madera/Hormigón  
🌳 Legno/Grigio  
🏠 Legno/Cemento

### 5 Talin

max. 20W, E27  
230V  
±130 ø90 mm  
EAN 4000870 796405



**796.40**

🌳 Wood 🏠 Wood  
🌳 Madera 🏠 Madera  
🌳 Legno 🏠 Legno





Perfect match

☐ = 409-412  
427

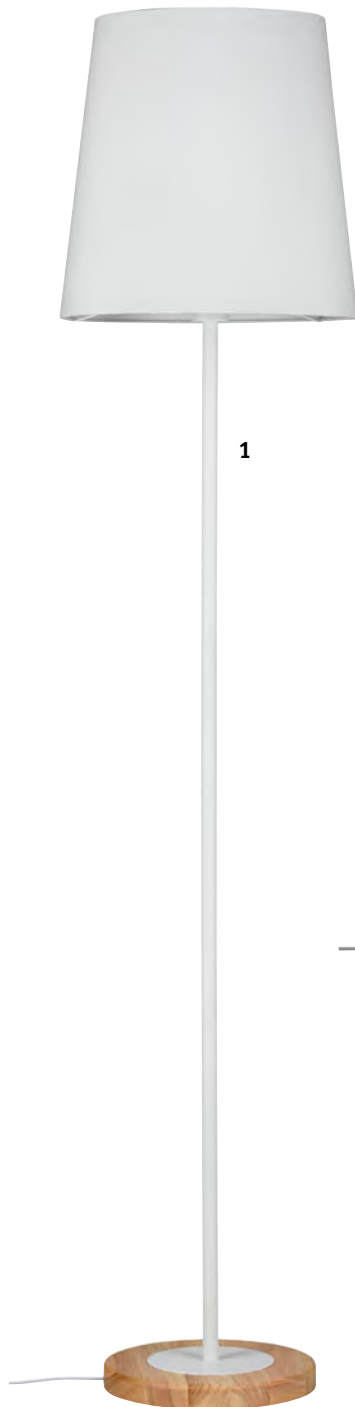

1



2



3

**1 Stellan**

max. 20 W, E27  
230 V  
↑ 1.615 ø 350 mm  
EAN 4000870 796344  
**796.34**

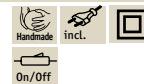

**2 Stellan**

max. 20 W, E27  
230 V  
↑ 400 ø 155 mm  
EAN 4000870 796368  
**796.36**



👉 White/Wood  
👉 Fabric/Metal/Wood  
👉 Blanco/Madera  
👉 Tela/Metal/Madera  
👉 Bianco/Legno  
👉 Tessuto/Metallo/Legno

**3 Berit**

max. 20 W, E27  
230 V  
↑ 315 ø 220 mm  
EAN 4000870 796467  
**796.46**



👉 White/Wood  
👉 Fabric/Wood/Metal  
👉 Blanco/Madera  
👉 Tela/Madera/Metal  
👉 Bianco/Legno  
👉 Tessuto/Legno/Metallo





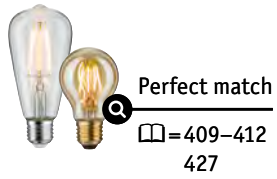

☐ = 409-412  
427

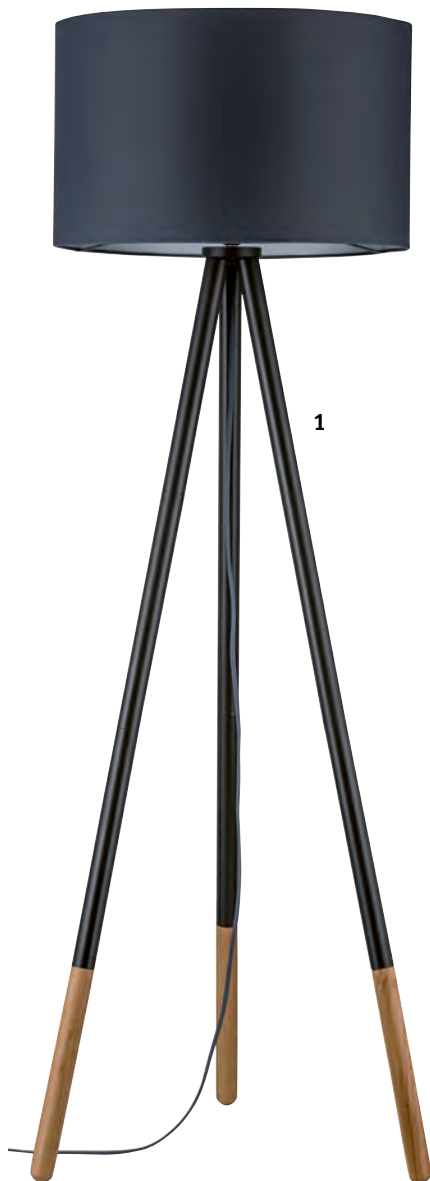

**1 Rurik**

max. 20W, E27  
230V  
↑ 1.530 ø 538 mm  
EAN 4000870 796337  
**796.33**



**2 Rurik**

max. 20W, E27  
230V  
↑ 700 ø 250 mm  
EAN 4000870 796351  
**796.35**



- 🪵 Grey/Wood
- 🧵 Fabric/Metal/Wood
- 🪵 Gris/Madera
- 🧵 Tela/Metal/Madera
- 🪵 Grigio/Legno
- 🧵 Tessuto/Metallo/Legno



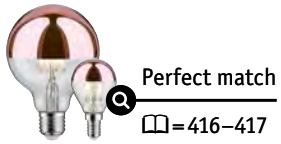

**1 Juna**

max. 20W, E14  
230V  
⌀110 cm ø160 mm  
EAN 4000870 796528  
**796.52**



**2 Juna**

max. 3×20W, E14  
230V  
⌀170 cm ø460 mm  
EAN 4000870 796535  
**796.53**



**3 Juna**

max. 20W, E27  
230V  
⌀110 cm ø342 mm  
EAN 4000870 796559  
**796.55**



**4 Juna**

max. 20W, E14  
230V  
⌀1.580 ⇄230  
⌀400 mm  
EAN 4000870 796542  
**796.54**



**5 Juna**

max. 20W, E14  
230V  
⌀510 ⇄180  
⌀255 mm  
EAN 4000870 796511  
**796.51**



- 🌿 Soft green/Copper/Wood
- 🏠 Metal/Wood
- 🌿 Verde satinado/Cobre/Madera
- 🏠 Metal/Madera
- 🌿 Verde tenue/Rame/Legno
- 🏠 Metallo/Legno

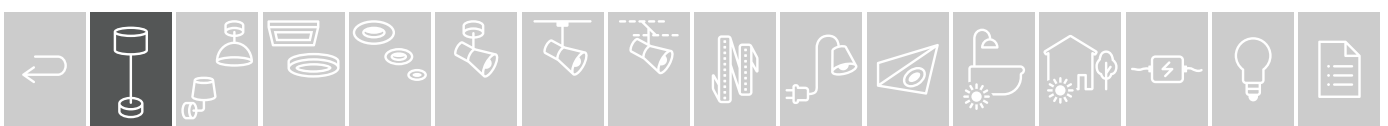
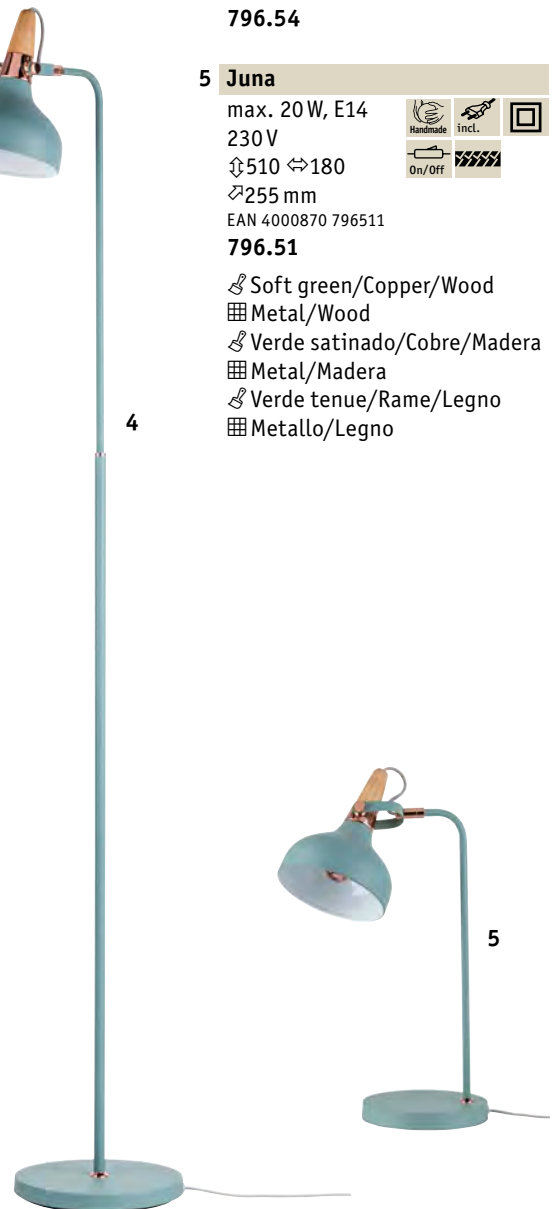



**1 Embla**

max. 20W, E27  
230V  
H 110 cm Ø 300 mm  
EAN 4000870 796283



**796.28**  
 ☞ Matt white/Gold ☞ Metal  
 ☞ Blanco mate/Oro ☞ Metal  
 ☞ Bianco opaco/Oro ☞ Metallo

**2 Embla**

max. 20W, E27  
230V  
H 110 cm Ø 300 mm  
EAN 4000870 796290



**796.29**  
 ☞ Black/Matt copper ☞ Metal  
 ☞ Negro/Cobre mate ☞ Metal  
 ☞ Nero/Rame opaco ☞ Metallo

**3 Haldis**

max. 20W, E27  
230V  
H 200 cm Ø 100 mm  
EAN 4000870 503874



**503.87**  
 ☞ Copper ☞ Metal  
 ☞ Cobre ☞ Metal  
 ☞ Rame ☞ Metallo

**4 Vanja**

max. 20W, E27  
230V  
H 110 cm Ø 200 mm  
EAN 4000870 796443



**796.44**  
 ☞ Matt white/Clear  
 ☞ Glass/Metal  
 ☞ Blanco mate/Transparente  
 ☞ Cristal/Metal  
 ☞ Bianco opaco/Trasparente  
 ☞ Vetro/Metallo

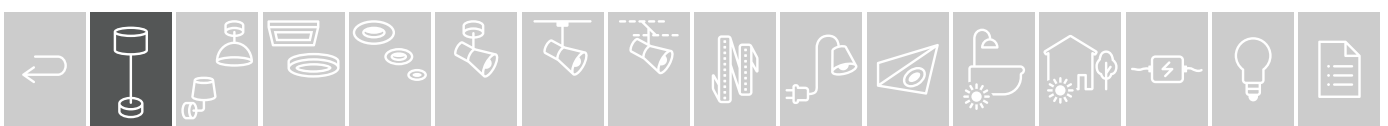



Perfect match

☐ = 416-417



2

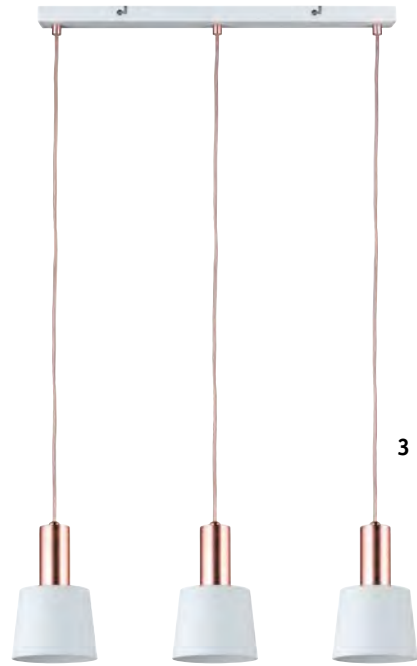

3



1



4



**1 Haldar**

max. 2×20 W, E14  
230 V  
⌈1.520 ⇄300  
∅230 mm  
EAN 4000870 796603  
**796.60**



**2 Haldar**

max. 20 W, E14  
230 V  
⌈110 cm ∅120 mm  
EAN 4000870 796566  
**796.56**

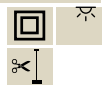

**3 Haldar**

max. 3×20 W, E14  
230 V  
⌈142 cm ∅120 mm  
⇄550 mm  
EAN 4000870 796573  
**796.57**



**4 Haldar**

max. 20 W, E14  
230 V  
⌈460 ∅160 mm  
EAN 4000870 796580  
**796.58**



👉 White/Matt copper ☐ Metal  
👉 Blanco/Cobre mate ☐ Metal  
👉 Bianco/Rame opaco ☐ Metallo





**1 Haldar**  
 max. 2x20 W, E14  
 230 V  
 ⚡1.520 ↔300  
 ⌀230 mm  
 EAN 4000870 796900  
**796.90**



**2 Haldar**  
 max. 20 W, E14  
 230 V  
 ⚡110 cm ø120 mm  
 EAN 4000870 796917  
**796.91**  
 🖌️ Dark grey/Chrome matt  
 🏠 Metal  
 🖌️ Gris oscuro/Cromo mate  
 🏠 Metal  
 🖌️ Grigio scuro/Cromo opaco  
 🏠 Metallo



**3 Thala**  
 max. 20 W, E14  
 230 V  
 ⚡1.410 ø300 mm  
 EAN 4000870 796825  
**796.82**  
 🖌️ Grey 🏠 Metal  
 🖌️ Gris 🏠 Metal  
 🖌️ Grigio 🏠 Metallo

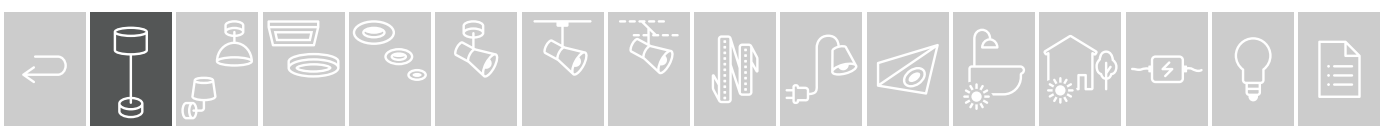



Perfect match

☐ = 409-423  
427-430

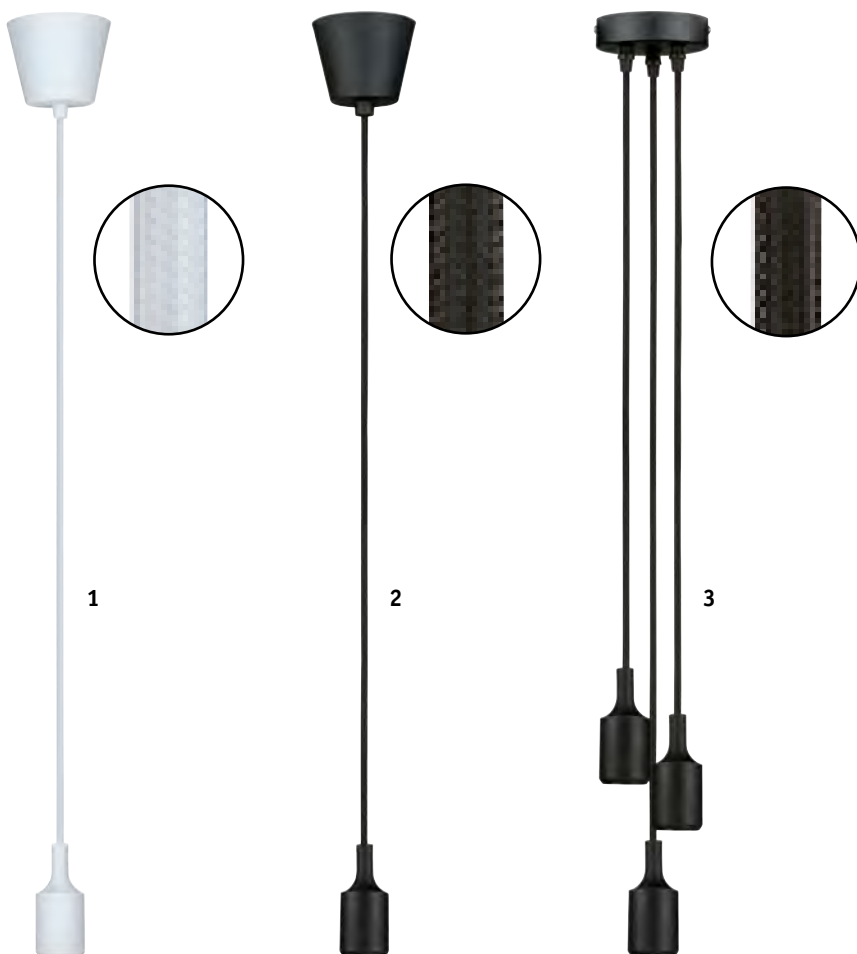

**1 Ketil**

max. 20W, E27  
230V  
⇅ 200 cm ø92 mm  
EAN 4000870 503836

**503.83**

- ☞ White ☐ Silicone/Plastic
- ☞ Blanco ☐ Silicona/Plástico
- ☞ Bianco ☐ Silicene/Plastica



**2 Ketil**

max. 20W, E27  
230V  
⇅ 200 cm ø92 mm  
EAN 4000870 503812

**503.81**

- ☞ Black ☐ Silicone/Plastic
- ☞ Negro ☐ Silicona/Plástico
- ☞ Nero ☐ Silicene/Plastica



**3 Ketil**

max. 3×20W, E27  
230V  
⇅ 200 cm ø100 mm  
EAN 4000870 503829

**503.82**

- ☞ Black ☐ Silicone/Metal
- ☞ Negro ☐ Silicona/Metal
- ☞ Nero ☐ Silicene/Metallo

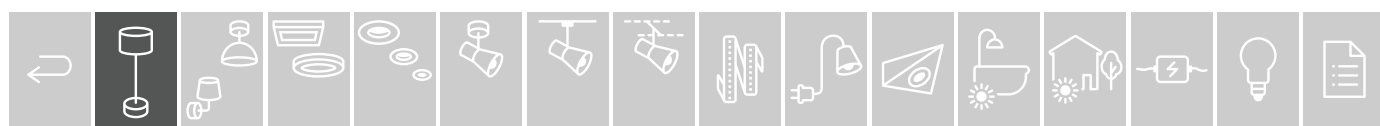



Perfect match  
 □ = 409-423  
 427-430



**1 Ketil**  
 max. 5x20 W, E27  
 230 V  
 ⚙ 200 cm ø150 mm  
 EAN 4000870 503898  
**503.89**

**2 Ketil**  
 max. 7x20 W, E27  
 230 V  
 ⚙ 200 cm ø150 mm  
 EAN 4000870 503904  
**503.90**

🖤 Black 🟩 Silicone/Metal  
 🖤 Negro 🟩 Silicona/Metal  
 🖤 Nero 🟩 Silicone/Metallo

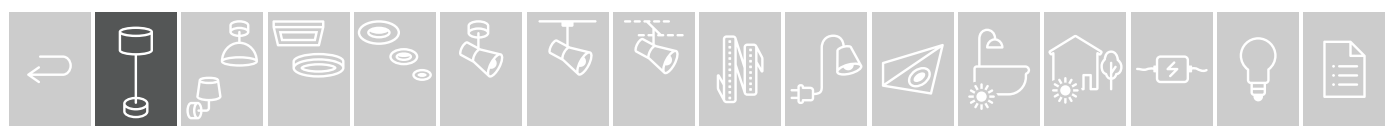



Perfect match  
 □ = 409-423  
 427-430



**1 Eldar**

max. 20W, E27  
 230V  
 ↑500 cm ø40 mm  
 EAN 4000870 797709  
**797.70** **new**

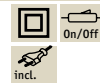

Red/Brushed nickel Metal  
 Rojo/Níquel mateado Metal  
 Rosso/Nichel spazzolato  
 Metallo

**2 Eldar**

max. 20W, E27  
 230V  
 ↑500 cm ø40 mm  
 EAN 4000870 797716  
**797.71** **new**

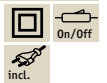

Grey/Nickel Metal  
 Gris/Níquel Metal  
 Grigio/Nichel Metallo

**3 Eldar**

max. 20W, E27  
 230V  
 ↑200 cm ø100 mm  
 EAN 4000870 503867  
**503.86**



Red/Brushed nickel Metal  
 Rojo/Níquel mateado Metal  
 Rosso/Nichel spazzolato  
 Metallo

**4 Eldar**

max. 20W, E27  
 230V  
 ↑200 cm ø100 mm  
 EAN 4000870 503850  
**503.85**



Grey/Nickel Metal  
 Gris/Níquel Metal  
 Grigio/Nichel Metallo







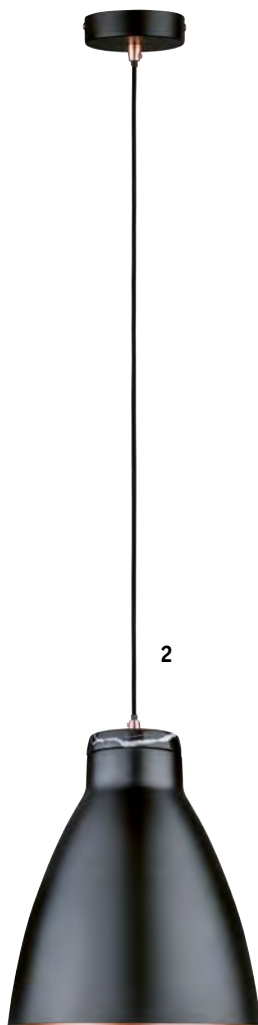
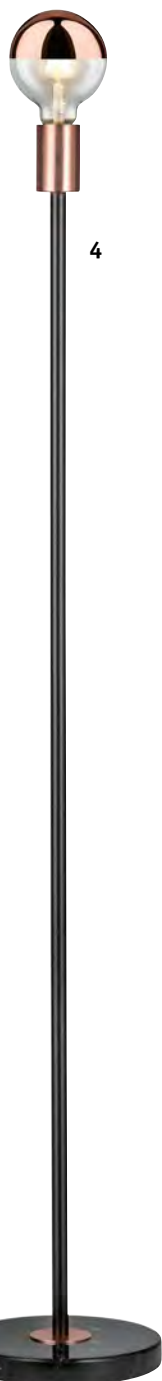
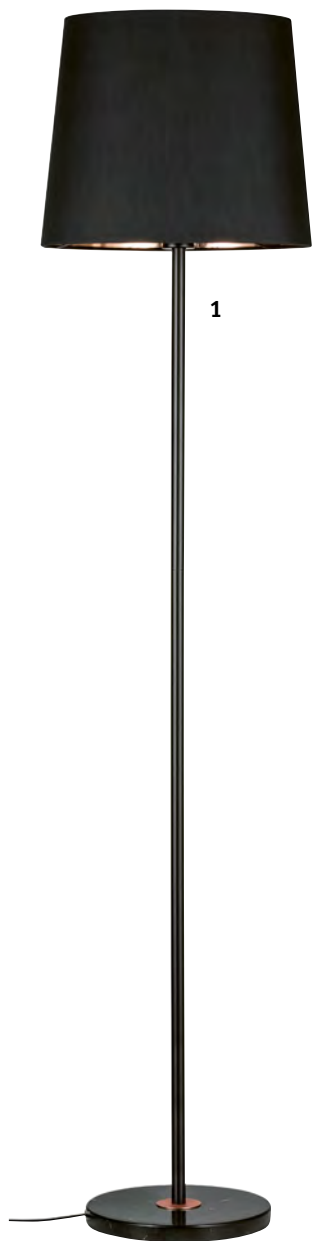

**1 Enja**

max. 20W, E27  
230V  
1.600 ø360 mm  
EAN 4000870 796122



**796.12**

- Black/Copper
- Fabric/Marble/Metal
- Negro/Cobre
- Tela/Mármol/Metal
- Nero/Rame
- Tessuto/Marmo/Metallo

**2 Roald**

max. 20W, E27  
230V  
110 cm  
ø260 mm  
EAN 4000870 796092



**796.09**

- Black matt/Matt copper
- Metal/Marble
- Negro mate/Cobre mate
- Metal/Mármol
- Nero opaco/Rame opaco
- Metallo/Marmo

**3 Nordin**

max. 20W, E27  
230V  
190 cm  
ø100 mm  
EAN 4000870 797518



**797.51**

- Black/Marble/Matt copper
- Marble
- Negro/Mármol/Cobre mate
- Mármol
- Nero/Marmo/Rame opaco
- Marmo

**4 Nordin**

max. 20W, E27  
230V  
1.200 ø200 mm  
EAN 4000870 796146



**796.14**

- Black/Matt copper
- Marble/Metal
- Negro/Cobre mate
- Mármol/Metal
- Nero/Rame opaco
- Marmo/Metallo

**5 Nordin**

max. 20W, E27  
230V  
130 ø95 mm  
EAN 4000870 796009



**796.00**

- Black Marble
- Negro Mármol
- Nero Marmo

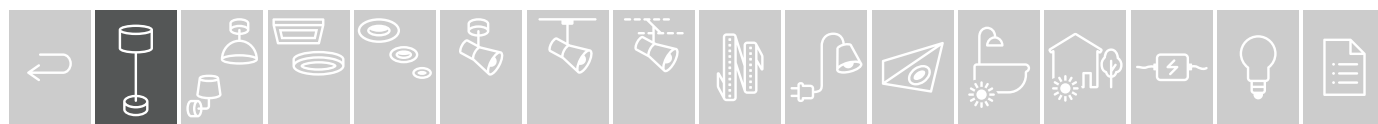

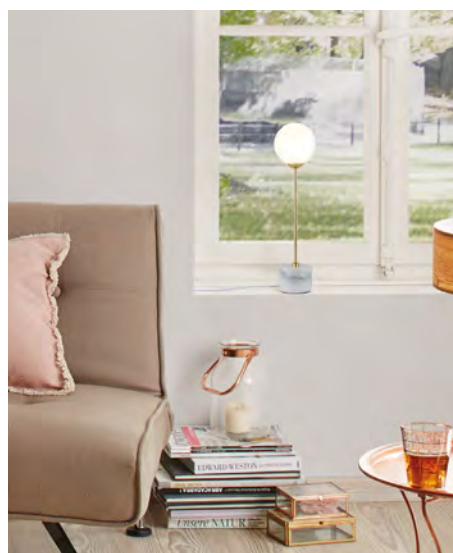
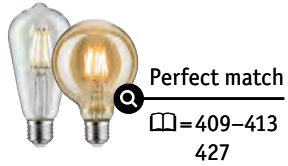

2



4



3

**1 Nordin**

max. 20 W, E27  
230 V  
190 cm  
100 mm  
EAN 4000870 797501



**797.50**

- ☞ White/Marble/Gold matt
- ☒ Marble
- ☞ Blanco/Mármol/Oro mate
- ☒ Mármol
- ☞ Bianco/Marmo/Oro opaco
- ☒ Marmo

**2 Nordin**

max. 20 W, E27  
230 V  
1.200 200 mm  
EAN 4000870 796153



**796.15**

- ☞ White/Gold matt
- ☒ Marble/Metal
- ☞ Blanco/Oro mate
- ☒ Mármol/Metal
- ☞ Bianco/Oro opaco
- ☒ Marmo/Metallo

**3 Nordin**

max. 20 W, E27  
230 V  
130 95 mm  
EAN 4000870 796016



**796.01**

- ☞ White ☒ Marble
- ☞ Blanco ☒ Mármol
- ☞ Bianco ☒ Marmo

**4 Moa**

max. 10 W, G9  
230 V  
400 100 mm  
EAN 4000870 796610



**796.61**

- ☞ White/Gold matt
- ☒ Glass/Marble/Metal
- ☞ Blanco/Oro mate
- ☒ Cristal/Mármol/Metal
- ☞ Bianco/Oro opaco
- ☒ Vetro/Marmo/Metallo



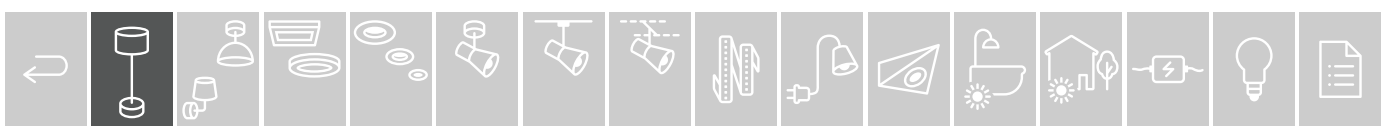
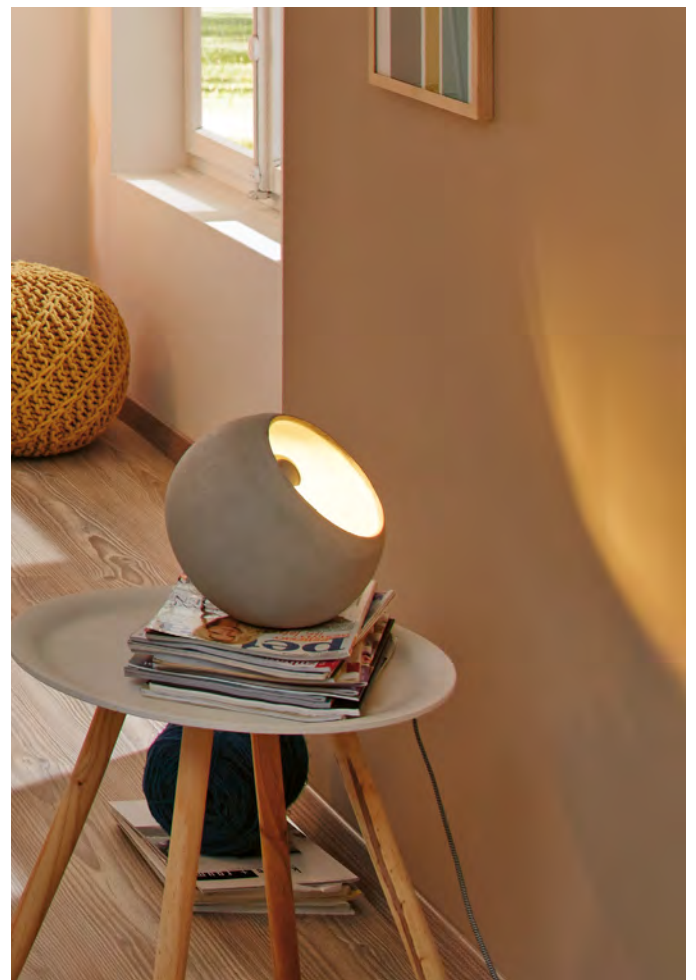



### 1 Henja

max. 20W, E27  
230V  
↑ 110 cm ø120 mm  
EAN 4000870 796184

**796.18**

- ☞ Grey/Brushed iron
- ☞ Concrete/Metal
- ☞ Gris/Hierro mateado
- ☞ Hormigón/Metal
- ☞ Grigio/Ferro spazzolato
- ☞ Cemento/Metallo



### 2 Helin

max. 20W, E27  
230V  
↑ 110 cm ø190 mm  
EAN 4000870 796160

**796.16**

- ☞ Grey/Satin ☞ Concrete/Glass
- ☞ Gris/Satinado
- ☞ Hormigón/Cristal
- ☞ Grigio/Satinato
- ☞ Cemento/Vetro



### 3 Jano

max. 20W, E27  
230V  
↑ 200 cm ø110 mm  
EAN 4000870 503881

**503.88**

- ☞ Grey/Black
- ☞ Concrete/Plastic
- ☞ Gris/Negro
- ☞ Hormigón/Plástico
- ☞ Grigio/Nero
- ☞ Cemento/Plastica



### 4 Mik

max. 20W, E27  
230V  
↑ 130 ø90 mm  
EAN 4000870 796214

**796.21**

- ☞ Grey ☞ Concrete
- ☞ Gris ☞ Hormigón
- ☞ Grigio ☞ Cemento





**1 Stig**

max. 20 W, E27  
230 V

↑ 110 cm ø120 mm

EAN 4000870 796177

**796.17**

- 👉 Grey/Matt copper
- 🏠 Concrete/Metal
- 👉 Gris/Cobre mate
- 🏠 Hormigón/Metal
- 👉 Grigio/Rame opaco
- 🏠 Cemento/Metallo



**2 Stig**

max. 3×20 W, E27  
230 V

↑ 110 cm

↔ 600 ↗ 100 mm

EAN 4000870 796269

**796.26**

- 👉 Grey/Matt copper
- 🏠 Concrete/Metal
- 👉 Gris/Cobre mate
- 🏠 Hormigón/Metal
- 👉 Grigio/Rame opaco
- 🏠 Cemento/Metallo



**3 Ingram**

max. 20 W, E27  
230 V

↑ 215 ø230 mm

EAN 4000870 796634

**796.63**

- 👉 Grey 🏠 Concrete
- 👉 Gris 🏠 Hormigón
- 👉 Grigio 🏠 Cemento

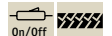

**4 Tem**

max. 20 W, E27  
230 V

↑ 340 ø220 mm

EAN 4000870 796221

**796.22**

- 👉 Grey/Copper
- 🏠 Fabric/Concrete/Metal
- 👉 Gris/Cobre
- 🏠 Tela/Hormigón/Metal
- 👉 Grigio/Rame
- 🏠 Tessuto/Cemento/Metallo

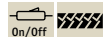



**1 Oda**

max. 20W, E27  
230V  
⌀137 cm ø250 mm  
EAN 4000870 796252



**796.25**

🔩 Matt white/Matt copper/Grey  
🏠 Metal/Concrete  
🔩 Blanco mate/Cobre mate/Gris  
🏠 Metal/Hormigón  
🔩 Bianco opaco/Rame opaco/  
Grigio 🏠 Metallo/Cemento

**2 Orm**

max. 20W, E27  
230V  
⌀500 ø150 mm  
EAN 4000870 796245



**796.24**

🔩 Grey/Matt copper  
🏠 Metal/Concrete  
🔩 Gris/Cobre mate  
🏠 Metal/Hormigón  
🔩 Grigio/Rame opaco  
🏠 Metallo/Cemento

**3 Yorik**

max. 20W, E27  
230V  
⌀350 ø200 mm  
EAN 4000870 796658



**796.65**

🔩 Clear/Grey/Copper  
🏠 Glass/Concrete/Metal  
🔩 Transparente/Gris/Cobre  
🏠 Cristal/Hormigón/Metal  
🔩 Trasparente/Grigio/Rame  
🏠 Vetro/Cemento/Metallo

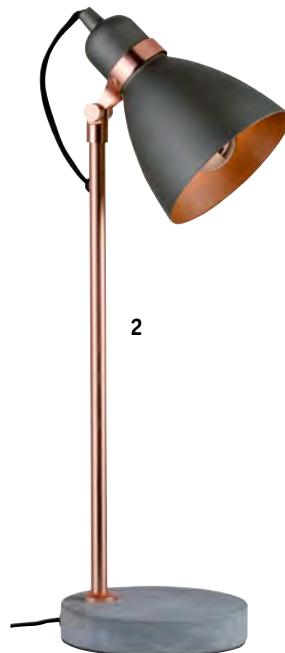
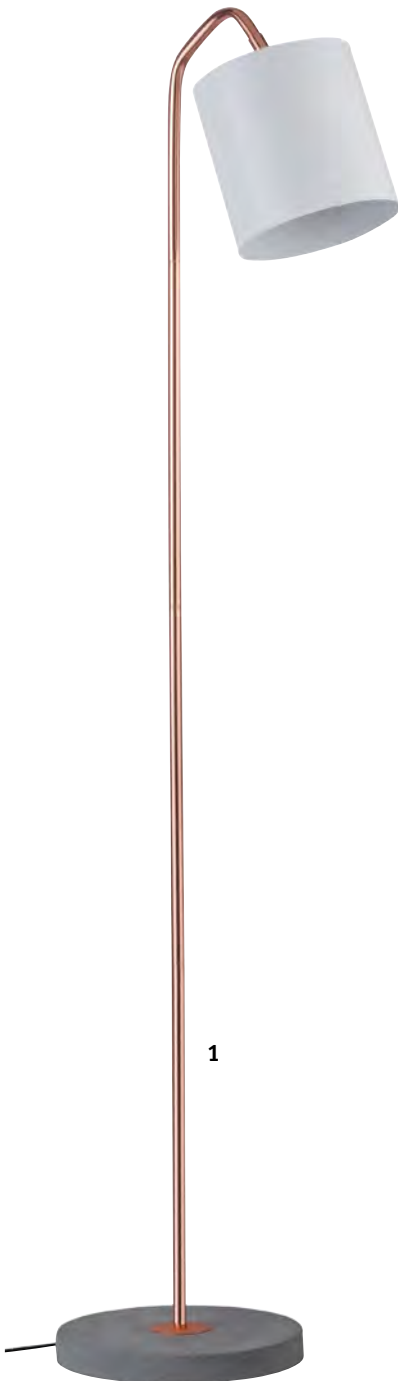



excl. Diffusor



incl. Diffusor

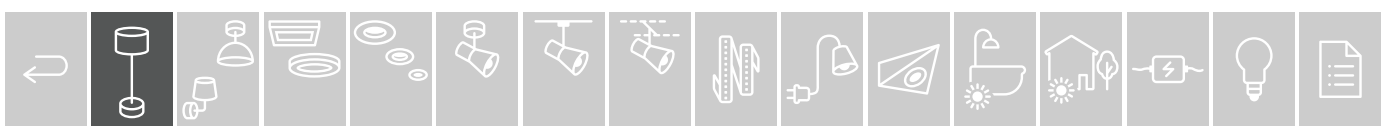





**1 Aldan**

incl. 1x4,6 /  
1x8,3 W  
635 + 910 lm,  
2.700 K  
230 V  
∅1.120-1.570 ∅275 mm  
EAN 4000870 797174  
**797.17**



**2 Aldan II**

incl. 1x10,7 W  
840 + 450 lm  
230 V  
∅85 mm ∅17,4-150 cm  
∅100 mm  
EAN 4000870 797860  
**797.86 new**

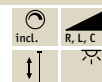

**3 Aldan**

incl. 3x4,8 / 3x4,4 W  
3x635 + 388 lm, 2.700 K  
230 V  
∅85 mm ∅8,9-150 cm  
∅100 mm ∅670 mm  
EAN 4000870 797204  
**797.20**

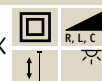

**4 Aldan**

incl. 1x4 W  
400 lm, 2.700 K  
∠ 80°  
230 V  
∅100 ∅100 mm  
EAN 4000870 797181  
**797.18**



- 🔘 Black/Brushed aluminium
- 🔘 Aluminium
- 🔘 Negro/Aluminio mateado
- 🔘 Aluminio
- 🔘 Nero/Alluminio spazzolato
- 🔘 Alluminio

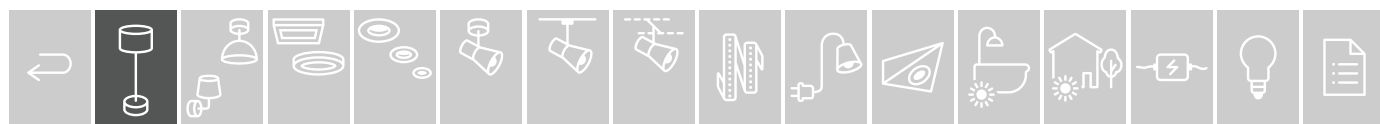

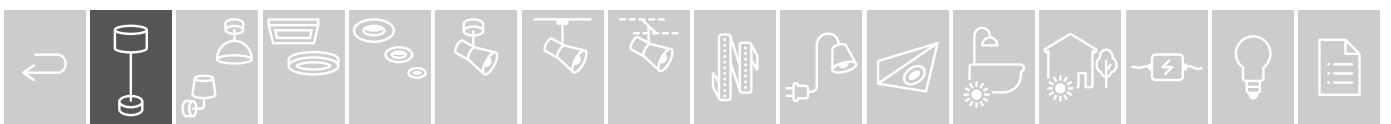

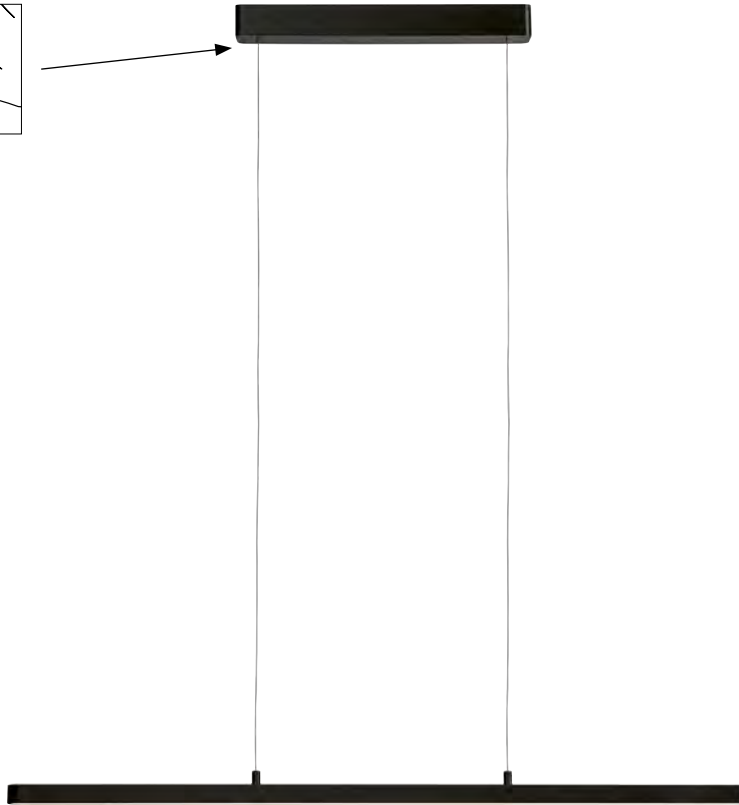
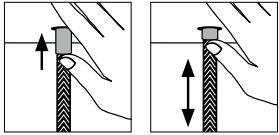

**Lento**

incl. 1×37 W  
 3.495 lm, 2.700 K  
 230 V  
 ⌀25 mm ⌀6,7-150 cm  
 ⇄1.000 mm ↗35 mm  
 EAN 4000870 796931

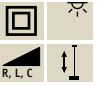

**796.93**

- 🔗 Black 📦 Aluminium/Plastic
- 🔗 Negro 📦 Aluminio/Plástico
- 🔗 Nero 📦 Alluminio/Plastica

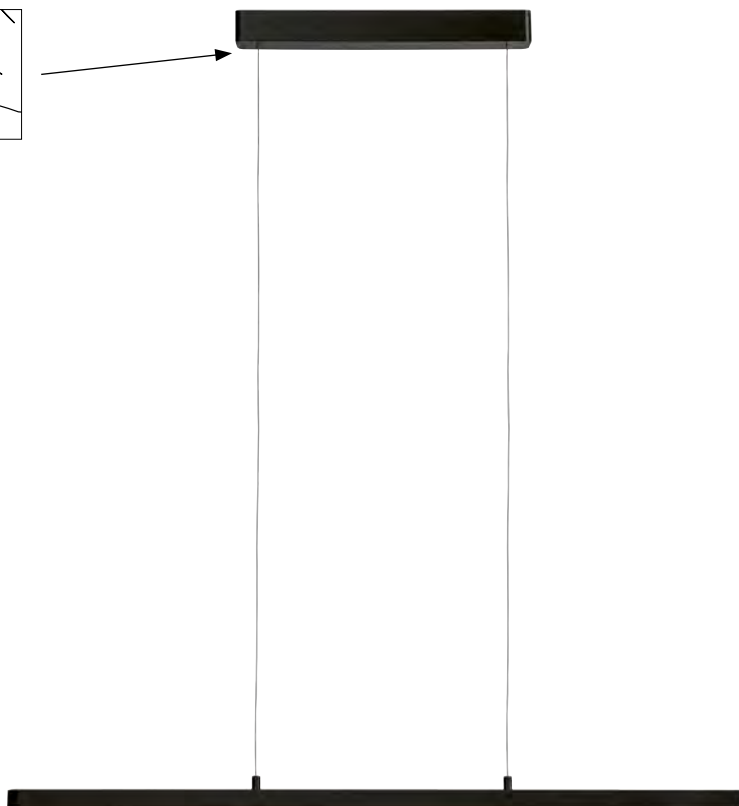
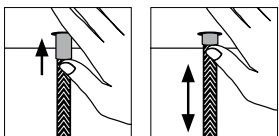

-  tunable white
-  smart controllable
-  Bluetooth®



**Lento**

incl. 1×40,5 W  
 3.570 lm, 2.700 - 6.500 K  
 230 V  
 ⌀25 mm ⌀6,7-150 cm  
 ⇄1.000 mm ↗35 mm  
 EAN 4000870 796948



**796.94**

- 🔗 Black 📦 Aluminium/Plastic
- 🔗 Negro 📦 Aluminio/Plástico
- 🔗 Nero 📦 Alluminio/Plastica



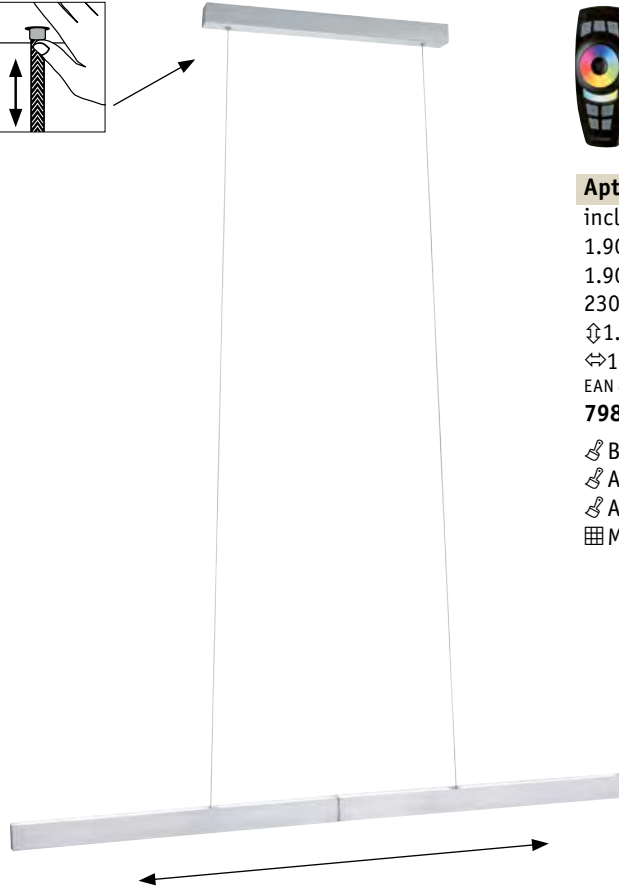
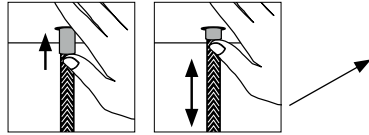

incl.



**Aptare**

incl. 1x18 W

1.900 +

1.900 lm, 2.700 K

230 V

⌀1.500 mm ⌀90-150 cm

⇄1.800 mm ↻50 mm

EAN 4000870 798157

**798.15**

🔩 Brushed aluminium 🏠 Metal

🔩 Aluminio mateado 🏠 Metal

🔩 Alluminio spazzolato

🏠 Metallo

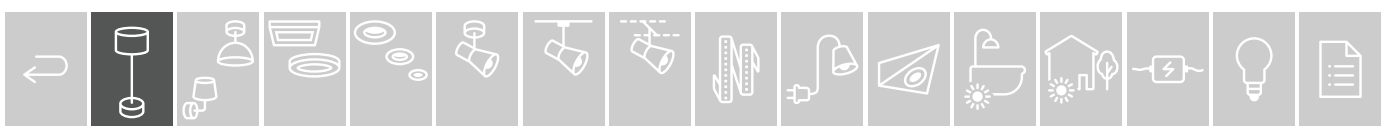
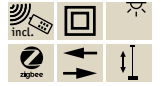

**Belaja**

incl. 1×24 W  
2.850 lm, 2.700 K  
230 V

↕1.480 ø425

↔448 mm

EAN 4000870 797211

**797.21**

🔩 White/Chrome matt 🏠 Metal  
🔩 Blanco/Cromo mate 🏠 Metal  
🔩 Bianco/Cromo opaco  
🏠 Metallo

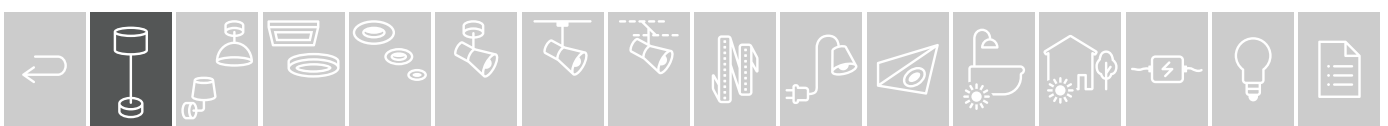

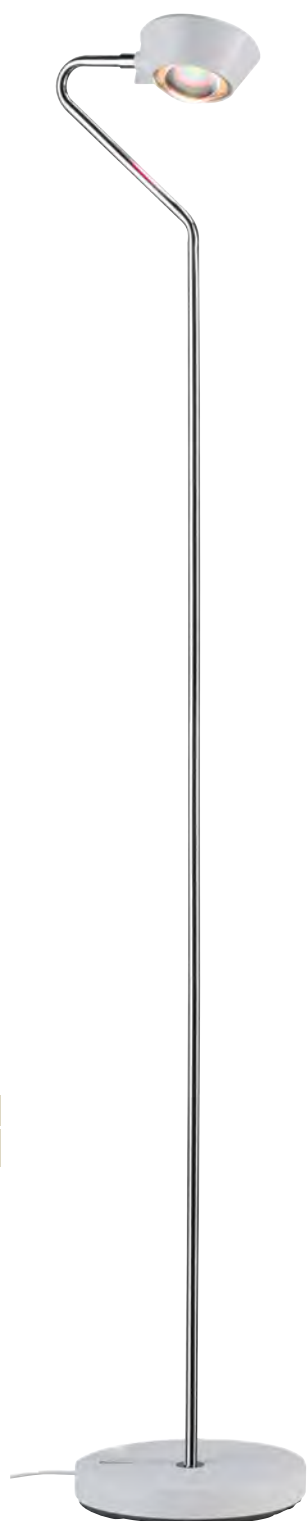

**Ramos**

incl. 1x7,5 /  
1x3,5 W

813 + 303 lm,  
3.000 K

230 V

∅1.415 ∅226 mm

EAN 4000870 709207

**709.20**

- 🔩 Matt white/Chrome
- 🔲 Plastic/Metal
- 🔩 Blanco mate/Cromo
- 🔲 Plástico/Metal
- 🔩 Bianco opaco/Cromo
- 🔲 Plastica/Metallo





**1 Sabik**

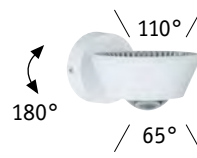

incl. 1x9 / 1x4,5 W  
840 + 320 lm, 2.700 K  
230 V  
∅80 ⇔117 ⌀152 mm  
EAN 4000870 709467



**709.46**

- ↳ Matt white ▣ Plastic
- ↳ Blanco mate ▣ Plástico
- ↳ Bianco opaco ▣ Plastica

**2 Sabik**

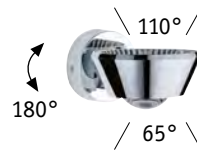

incl. 1x9 / 1x4,5 W  
840 + 320 lm, 2.700 K  
230 V  
∅80 ⇔117 ⌀152 mm  
EAN 4000870 709474



**709.47**

- ↳ Chrome ▣ Plastic
- ↳ Cromo ▣ Plástico
- ↳ Cromo ▣ Plastica

**3 Sabik**



incl. 1x9 / 1x4 W  
840 + 320 lm, 2.700 K  
230 V  
∅80 ⇔117 ⌀152 mm  
EAN 4000870 797693



**797.69 new**

- ↳ Black ▣ Plastic
- ↳ Negro ▣ Plástico
- ↳ Nero ▣ Plastica



1



2



3

incl. dichroic foil 

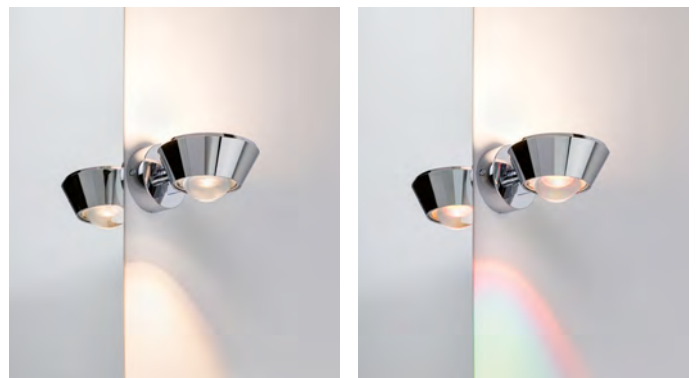

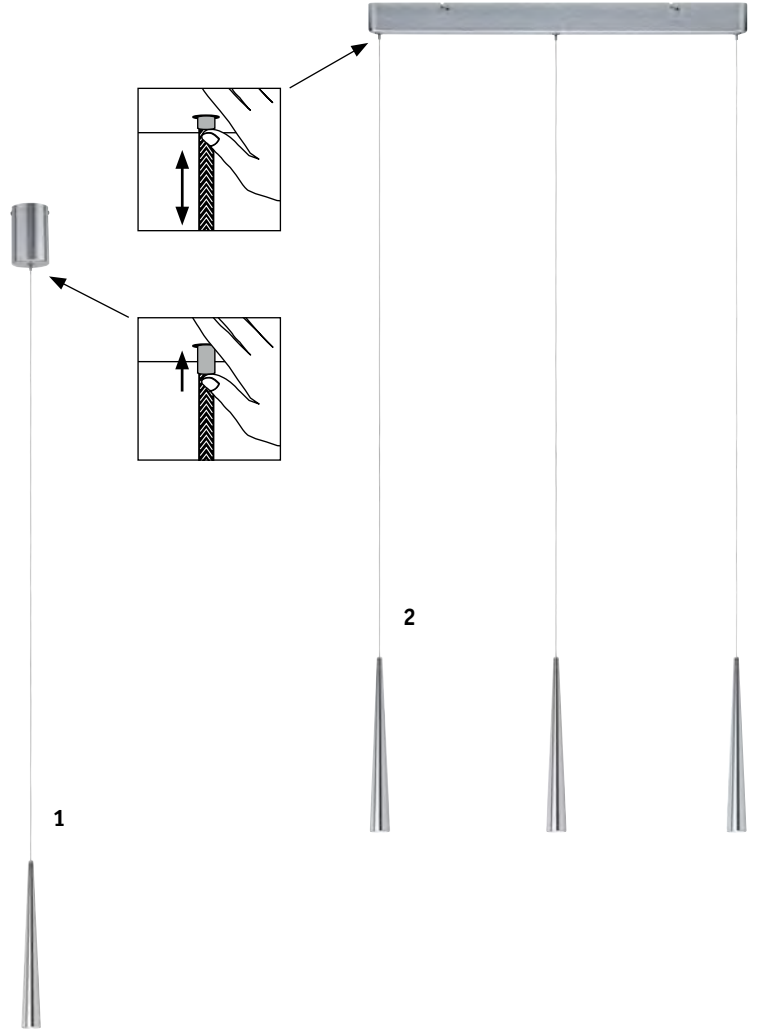

**1 Gutta**

incl. 1×6,4 W  
600 lm, 2.700 K  
230 V  
⇅40,1-150 cm ø72 mm  
EAN 4000870 709290  
**709.29**

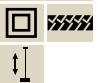

**2 Gutta**

incl. 3×6,4 W  
3×580 + 0 lm, 2.700 K  
230 V  
⇅40,1-150 cm ø33 mm  
⇄670 mm ø36 mm  
EAN 4000870 709306  
**709.30**

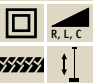

🔧 Brushed aluminium 🧱 Metal  
🔧 Aluminio mateado 🧱 Metal  
🔧 Alluminio spazzolato  
🧱 Metallo

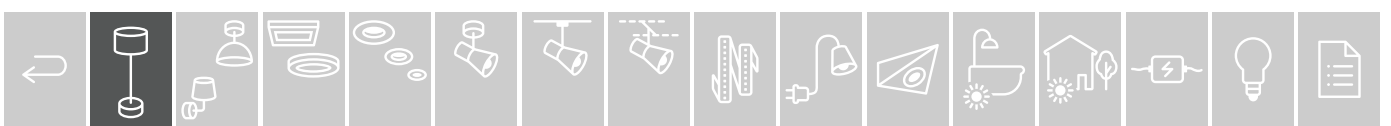



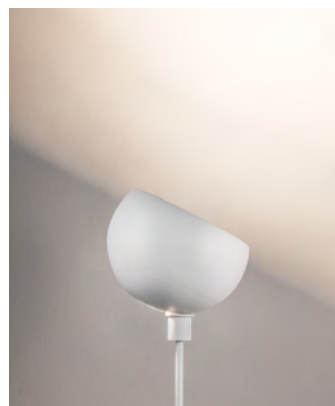
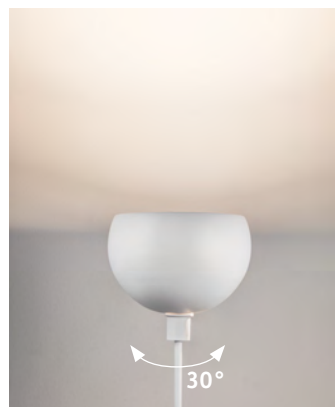
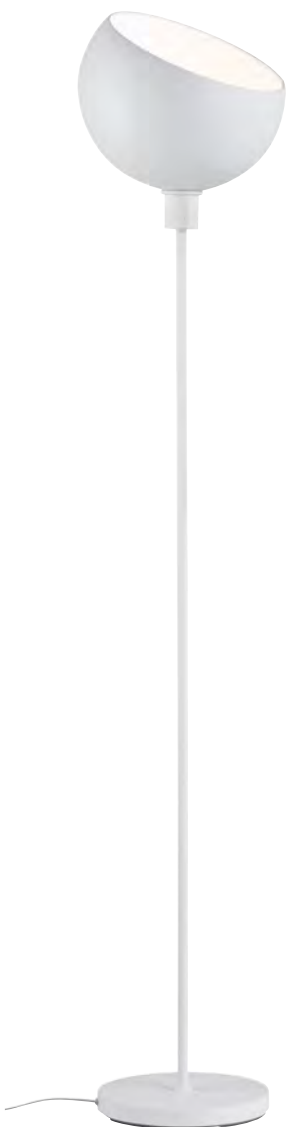

**Gambia**

max. 60W, E27  
230V

∅1.522 ∅300 mm  
EAN 4000870 709283

**709.28**

- 👉 Matt white 🏠 Metal
- 👉 Blanco mate 🏠 Metal
- 👉 Bianco opaco 🏠 Metallo

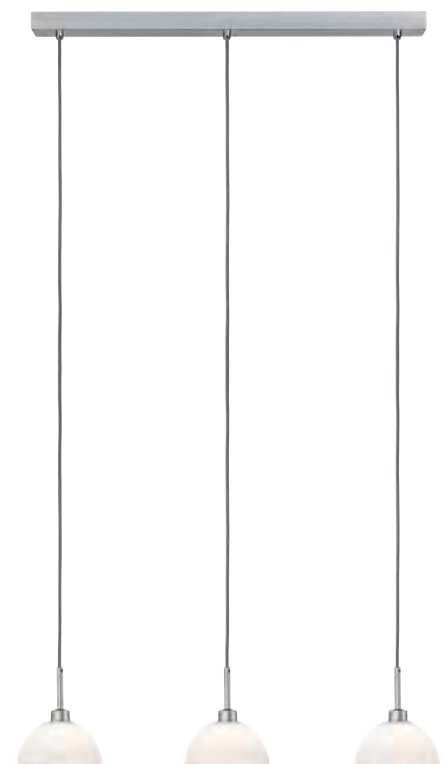

**Parana**

max. 3x40W, GU10  
230V

∅110 cm ∅690 mm  
EAN 4000870 709252

**709.25**

- 👉 White/Chrome matt
- 🏠 Glass/Metal
- 👉 Blanco/Cromo mate
- 🏠 Cristal/Metal
- 👉 Bianco/Cromo opaco
- 🏠 Vetro/Metallo



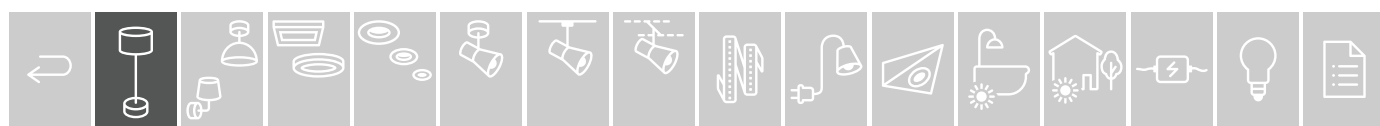
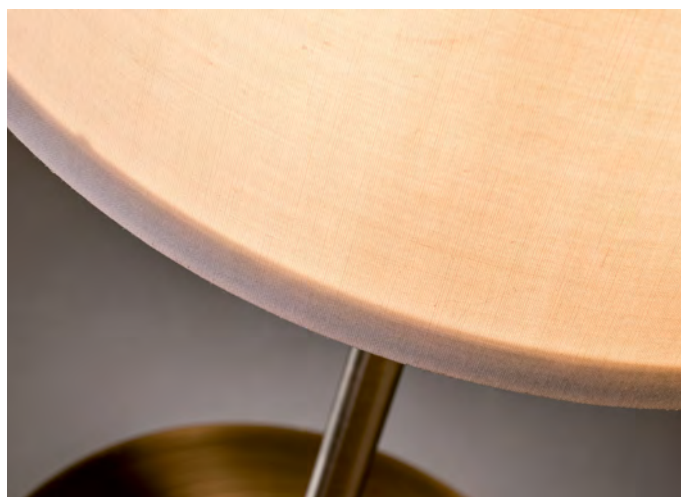

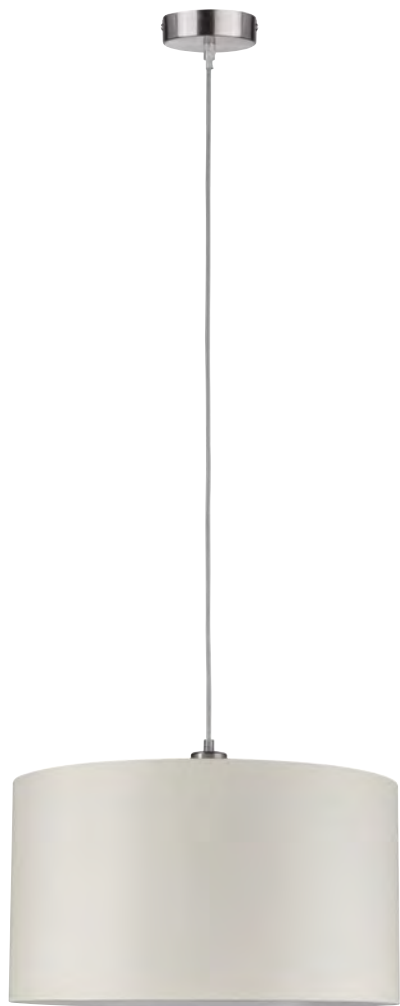

1

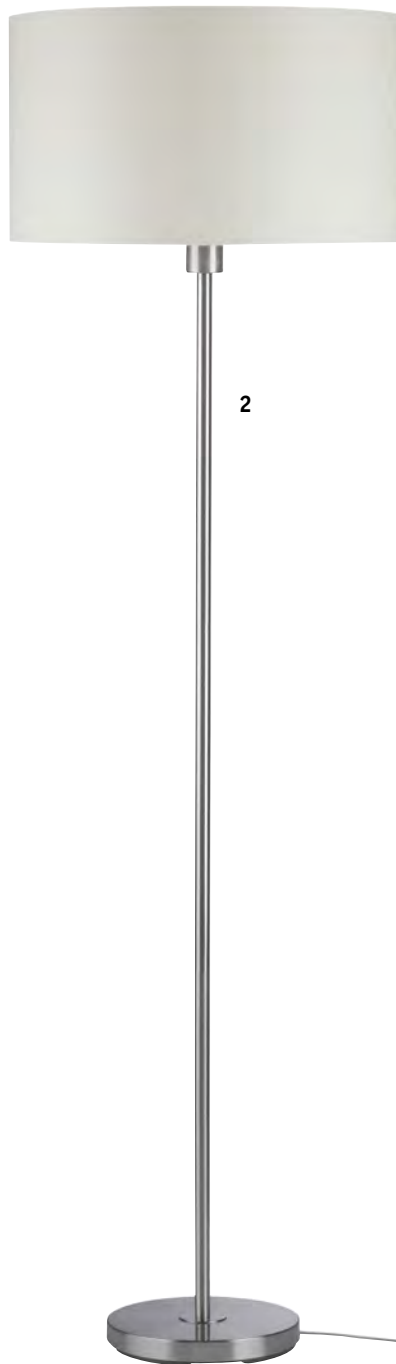

2



3

**1 Tessa**

max. 60W, E27  
230V  
∅110 cm ∅450 mm  
EAN 4000870 709245  
**709.24**



**2 Tessa**

max. 60W, E27  
230V  
∅1.600 ∅450 mm  
EAN 4000870 709221  
**709.22**

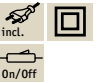

**3 Tessa**

max. 40W, E14  
230V  
∅450 ∅250 mm  
EAN 4000870 709238  
**709.23**

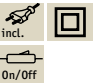

- ☞ Cream/Brushed iron
- ☞ Metal/Fabric
- ☞ Crema/Hierro mateado
- ☞ Metal/Tela
- ☞ Crema/Ferro spazzolato
- ☞ Metallo/Tessuto



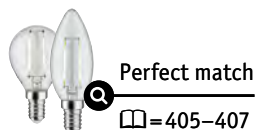

**1 Noora**

max. 42 W, E14  
230 V  
∅210 ø80 mm  
EAN 4000870 770108

**770.10**

- Opal Glass
- Opal Cristal
- Opale Vetro



**2 Pia**

max. 25 W, E14  
230 V  
∅210 ø100 mm  
EAN 4000870 770580

**770.58**

- White/Brushed iron
- Metal/Fabric
- Blanco/Hierro mateado
- Metal/Tela
- Bianco/Ferro spazzolato
- Metallo/Tessuto



**3 Pia**

max. 25 W, E14  
230 V  
∅210 ø100 mm  
EAN 4000870 770597

**770.59**

- Black matt Metal/Fabric
- Negro mate Metal/Tela
- Nero opaco Metallo/Tessuto

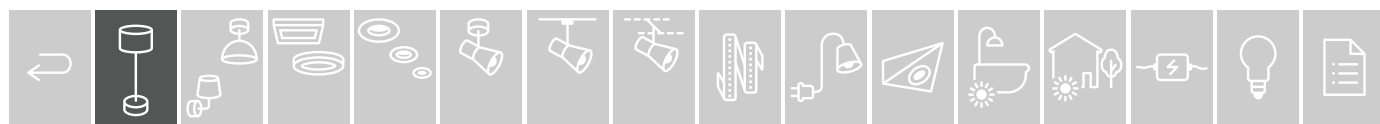



3 step dimmable

only with 287.38, 287.39



1



2



3

**1 Pinja**

max. 20 W, E14

230 V

⌀244 ø110 mm

EAN 4000870 770559

**770.55**

☞ White/Brushed brass

☒ Metal/Glass

☞ Blanco/Latón mateado

☒ Metal/Cristal

☞ Bianco/Ottone spazzolato

☒ Metallo/Vetro

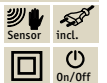
**2 Pinja**

max. 20 W, E14

230 V

⌀244 ø110 mm

EAN 4000870 770566

**770.56**

☞ Chrome/Opal ☒ Metal/Glass

☞ Cromo/Opal ☒ Metal/Cristal

☞ Cromo/Opale ☒ Metallo/Vetro

**3 Aari**

max. 20 W, E14

230 V

⌀240 ø200 mm

EAN 4000870 770573

**770.57**

☞ Chrome/Smoke glass

☒ Metal/Glass

☞ Cromo/Vidrio ahumado

☒ Metal/Cristal

☞ Cromo/Vetro opaco

☒ Metallo/Vetro

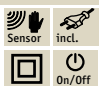

# Wall & Ceiling

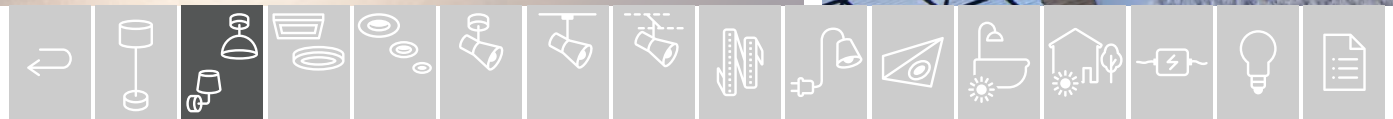

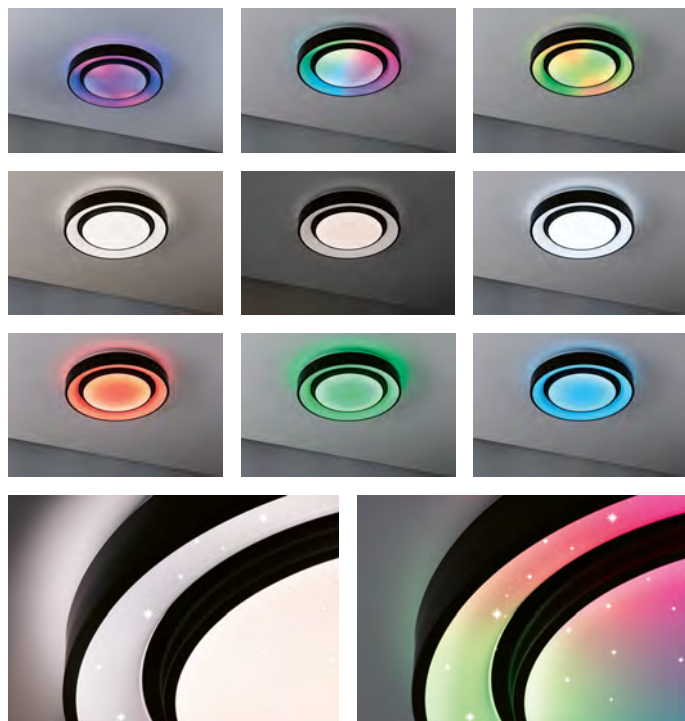

**Rainbow**  
 incl. 1x22 W  
 2.650 lm  
 3.000–6.500 K  
 230 V  
 ⌀70 ø375 mm  
 EAN 4000870 705445  
**705.44 new**



**Rainbow**  
 incl. 1x38,5 W  
 4.750 lm  
 3.000–6.500 K  
 230 V  
 ⌀70 ø475 mm  
 EAN 4000870 705452  
**705.45 new**



incl.

🌀 Black/White 🗪 Plastic/Metal  
 🌀 Negro/Blanco 🗪 Plástico/Metal  
 🌀 Nero/Bianco 🗪 Plastica/Metallo



**Rainbow**  
 incl. 1x22 W  
 2.650 lm  
 3.000–6.500 K  
 230 V  
 ⌀75 ø380 mm  
 EAN 4000870 705469  
**705.46 new**

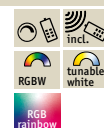

**Rainbow**  
 incl. 1x38,5 W  
 4.750 lm  
 3.000–6.500 K  
 230 V  
 ⌀75 ø485 mm  
 EAN 4000870 705476  
**705.47 new**



incl.

🌀 Chrome/White 🗪 Plastic/Metal  
 🌀 Cromo/Blanco 🗪 Plástico/Metal  
 🌀 Cromo/Bianco 🗪 Plastica/Metallo

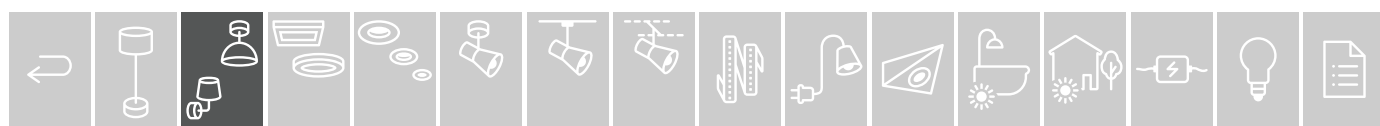



1x click 100%



2x click 50%



3x click 25%



3 step dim



### Ardora

incl. 1x31 W  
2.956lm, 2.700 K  
230 V  
⌀85,5 ⌀450 mm  
EAN 4000870 709061  
**709.06**



- 🌀 White 🗪 Metal/Plastic
- 🌀 Blanco 🗪 Metal/Plástico
- 🌀 Bianco 🗪 Metallo/Plastica



### Liao

incl. 1x4,9 W  
500 lm, 3.000 K  
⊲ 110°  
230 V  
⌀33 ⌀125 mm  
EAN 4000870 709429  
**709.42**



- 🌀 Matt white/Chrome 🗪 Metal
- 🌀 Blanco mate/Cromo 🗪 Metal
- 🌀 Bianco opaco/Cromo 🗪 Metallo

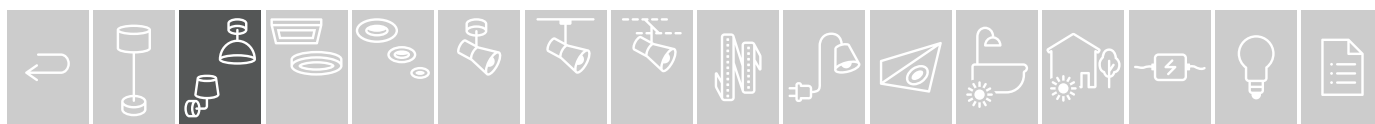





incl. memory function



1x click 100%









2x click 50%



3x click 25%

 3 step dim

-  Brushed aluminium  Metal
-  Aluminio mateado  Metal
-  Alluminio spazzolato  Metallo



**Argun**

incl. 1x4,2 W  
358 lm, 3.000 K  
230 V  
⌀60 ø97 mm  
EAN 4000870 797082  
**797.08**



**Argun**

incl. 2x4,2 W  
2x358 lm, 3.000 K  
230 V  
⌀60 ⇄189 ⇄97 mm  
EAN 4000870 797099  
**797.09**



**Argun**

incl. 3x4,2 W  
3x358 lm, 3.000 K  
230 V  
⌀60 ⇄284 ⇄97 mm  
EAN 4000870 797105  
**797.10**

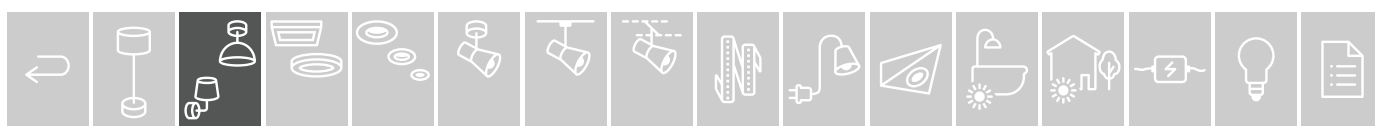



**Mari**  
 max. 2x20 W, E27  
 230 V  
 ⚡130 ø380 mm  
 EAN 4000870 709511  
**709.51**  
 📏 Blue 🧵 Fabric  
 📏 Azul 🧵 Tela  
 📏 Blu 🧵 Tessuto



**Mari**  
 max. 2x20 W, E27  
 230 V  
 ⚡130 ø380 mm  
 EAN 4000870 709528  
**709.52**  
 📏 Beige 🧵 Fabric  
 📏 Beige 🧵 Tela  
 📏 Beige 🧵 Tessuto







**Calvani**

max. 40W, E27  
230V  
⌀340 ⇄100 ↗165 mm  
EAN 4000870 798119

**798.11**

- 👉 White 🏠 Metal
- 👉 Blanco 🏠 Metal
- 👉 Bianco 🏠 Metallo

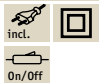

incl. USB Charger DC5V 2A



**Calvani**

max. 40W, E27  
230V  
⌀350 ⇄200 ↗170 mm  
EAN 4000870 798126

**798.12**

- 👉 White 🏠 Metal
- 👉 Blanco 🏠 Metal
- 👉 Bianco 🏠 Metallo

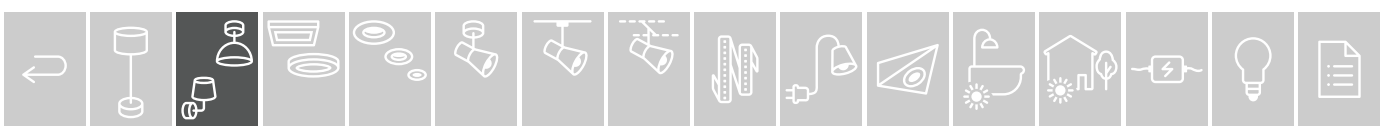



incl.  
USB Charger  
DC5V 2A



### Merani

incl. 1x2,5 W, E27  
140 lm, 3.000 K

∠ 23°

230 V

∅355 ∅250 ∅160 mm

EAN 4000870 789131

**789.13**

🔗 Grey/White 📦 Metal/Fabric

🔗 Gris/Blanco 📦 Metal/Tela

🔗 Grigio/Bianco 📦 Metallo/Tessuto



### Kian

max. 40 W, E27

230 V

∅180 ∅45 ∅220 mm

EAN 4000870 789148

**789.14**

🔗 Wood/Black 📦 Metal/Wood

🔗 Madera/Negro 📦 Metal/Madera

🔗 Legno/Nero 📦 Metallo/Legno

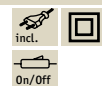



incl. USB Charger DC5V 2A



**Devara**

max. 40W, E27  
230V  
130 ⇄ 400 170 mm  
EAN 4000870 789155

**789.15**

- 🔗 White 🏠 Metal
- 🔗 Blanco 🏠 Metal
- 🔗 Bianco 🏠 Metallo



incl. USB Charger DC5V 2A



**Devara**

max. 40W, E27  
230V  
130 ⇄ 400 170 mm  
EAN 4000870 789209

**789.20**

- 🔗 Black 🏠 Metal
- 🔗 Negro 🏠 Metal
- 🔗 Nero 🏠 Metallo

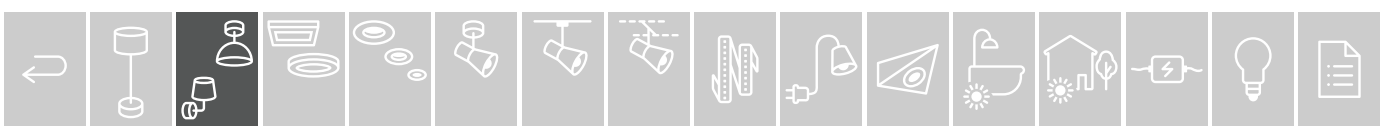

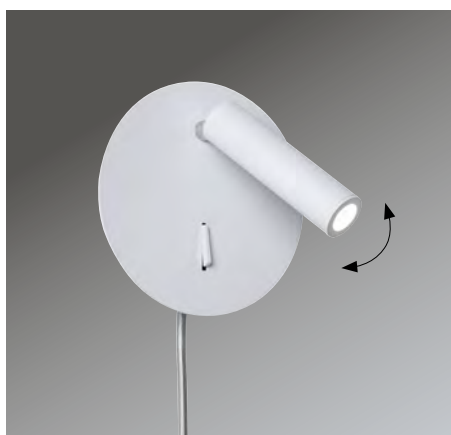

**Tabari**

incl. 1x3,2 W  
300 lm, 3.000 K  
∠ 38°  
230 V  
∅75 ∅140 mm  
EAN 4000870 789179

**789.17**

- 🔌 White/Chrome 🏠 Metal
- 🔌 Blanco/Cromo 🏠 Metal
- 🔌 Bianco/Cromo 🏠 Metallo

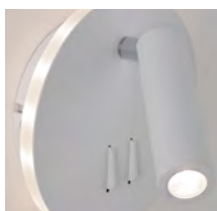
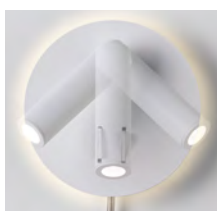
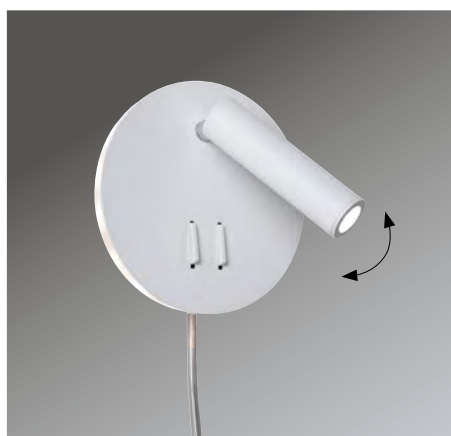

**Tabari**

incl. 1x3,25 / 1x2,4 W  
365 + 105 lm, 3.000 K  
∠ 38°  
230 V  
∅75 ∅140 mm  
EAN 4000870 789186

**789.18**

- 🔌 White/Chrome 🏠 Metal
- 🔌 Blanco/Cromo 🏠 Metal
- 🔌 Bianco/Cromo 🏠 Metallo

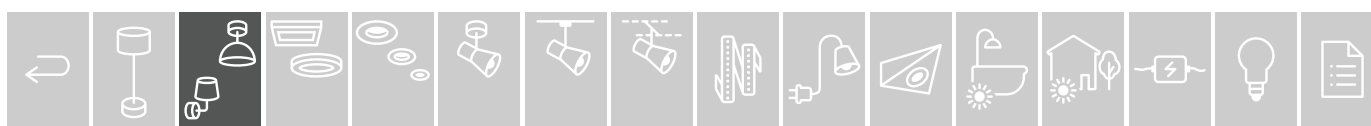



incl. USB Charger DC5V 2A

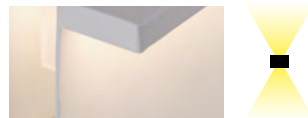

**Jarina**

incl. 1x4,5 / 1x1,6 W  
540 + 200 lm, 3.000 K  
230 V  
⇅200 ⇄350 ↗170 mm  
EAN 4000870 789193

**789.19**

- 👉 White 🏠 Metal
- 👉 Blanco 🏠 Metal
- 👉 Bianco 🏠 Metallo

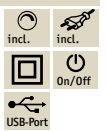

incl. USB Charger DC5V 2A



**Jarina**

incl. 1x4,5 W  
540 lm, 3.000 K  
230 V  
⇅200 ⇄350 ↗170 mm  
EAN 4000870 789162

**789.16**

- 👉 White 🏠 Metal
- 👉 Blanco 🏠 Metal
- 👉 Bianco 🏠 Metallo

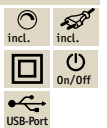





- 🔗 White 🏠 Aluminium
- 🔗 Blanco 🏠 Aluminio
- 🔗 Bianco 🏠 Alluminio



**Bar**

incl. 1×5,5 W  
 765 lm, 2.700 K  
 230 V, incl. ⚡ 6 VA  
 ⚡70 ⇔200 ⚡100 mm  
 EAN 4000870 707906  
**707.90**



**Bar**

incl. 1×10,5 W  
 1.500 lm, 2.700 K  
 230 V, incl. ⚡ 12 VA  
 ⚡70 ⇔400 ⚡100 mm  
 EAN 4000870 707913  
**707.91**



**Bocca**

incl. 2×3 W  
 2×305 lm, 2.700 K  
 230 V, incl. ⚡ 6 VA  
 ⚡100 ⇔140 ⚡52 mm  
 EAN 4000870 707920  
**707.92**



- 🔗 White 🏠 Aluminium
- 🔗 Blanco 🏠 Aluminio
- 🔗 Bianco 🏠 Alluminio

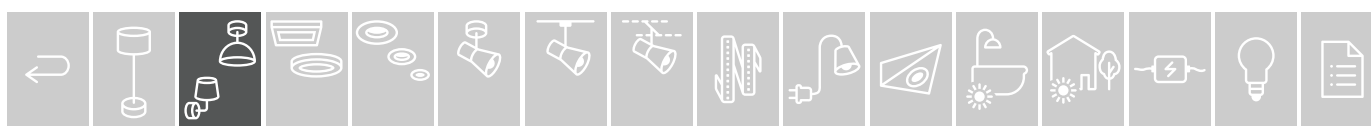

# Panels



## Full coverage light for any application

LED panels for versatility – as a wall or ceiling luminaire, LED panels light up any space uniformly and evenly. The understated design and flat shape allow the panels to optimally blend into living or functional spaces.

## Luz difusa para cualquier aplicación

Los paneles LED tienen múltiples aplicaciones. Ya sea como apliques o plafones, los paneles LED iluminan cualquier estancia con una luz uniforme y difusa. Con su diseño discreto y plano, los paneles se incorporan a la perfección en la vivienda y en espacios funcionales.

## Luce uniforme per ogni applicazione

I pannelli a LED sono molto versatili poiché, utilizzati come applique o plafoniere, permettono di illuminare ogni ambiente in modo uniforme. Grazie al design discreto e alla forma piatta, i pannelli si integrano perfettamente negli spazi abitativi e funzionali.

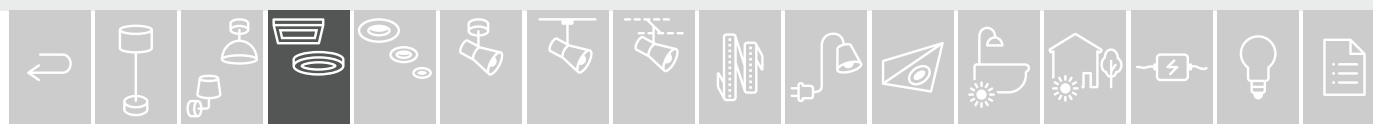
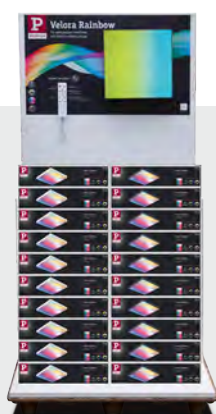

☒ = 75

EN Five trendy colours: white, chrome, chrome matt, black, rosé gold  
ES Cinco colores actuales: blanco, cromo, cromo mate, negro, oro rosa  
IT Cinque colori moderni: bianco, cromo, cromo opaco, nero, oro rosa



EN New colours: lilac, grey-blue, midnight blue, dark grey  
ES Nuevos colores: lila, gris azulado, azul noche, gris oscuro  
IT Nuovi colori: lillà, grigio, blu notte, grigio scuro

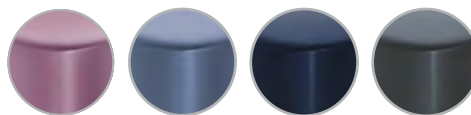

☒ = 78



☒ = 440



☒ = 440

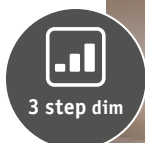

☒ = 82



☒ = 85

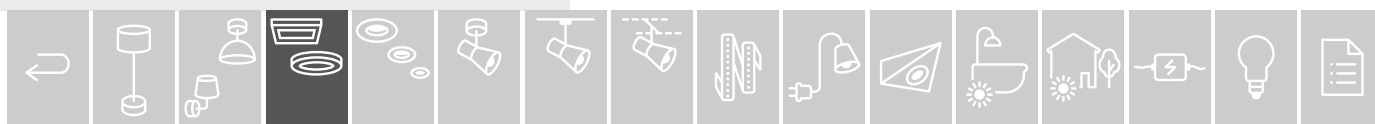
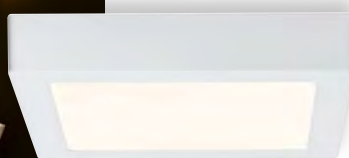
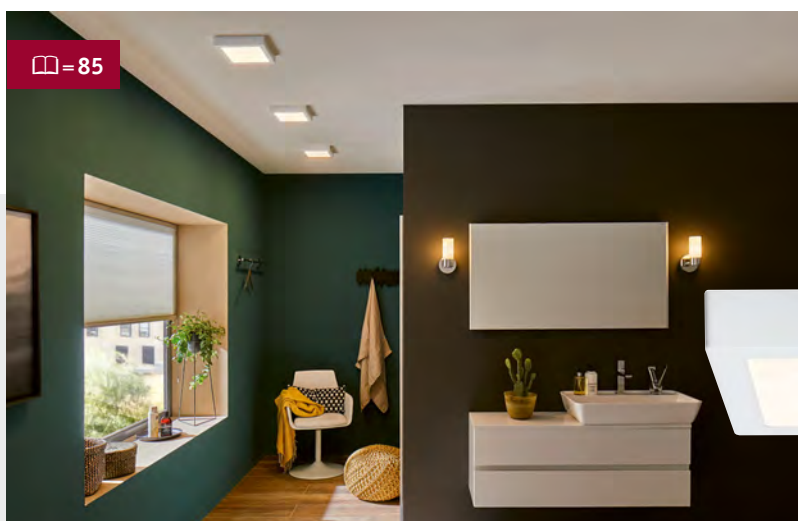



- ▶ Panels of pure light in a floating frame with an installation height of up to 69 mm
- ▶ Shadow and glare-free lighting for every room
- ▶ Controllable and smart variants

- ▶ Superficies de luz pura en el marco flotante con una altura de montaje de hasta 69 mm
- ▶ Iluminación sin sombras ni deslumbramiento para cualquier estancia
- ▶ Variantes controlables e inteligentes

- ▶ Superfici di luce pura in una cornice fluttuante con un'altezza di incasso fino a 69 mm
- ▶ Illuminazione che non abbaglia e senza ombre in ogni ambiente
- ▶ Varianti comandabili e smart

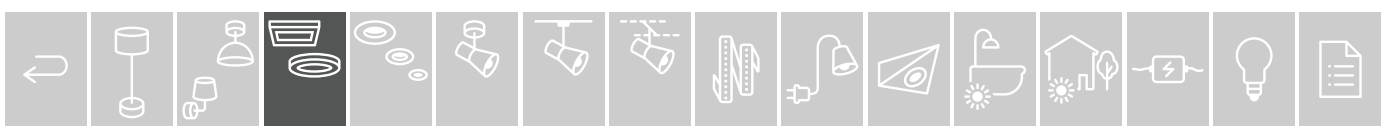



smart  
controllable  
**zigbee**



**Velora** Metal Metal Metallo 230V

tunable white = 2.700 - 6.500 K

	<b>⇄225 ⇄225 mm</b>
<b>W</b> 1.020 lm   incl. 1×8,5 W	EAN 4000870 798249 <b>798.24</b>
	<b>⇄295 ⇄295 mm</b>
<b>W</b> 1.330 lm   incl. 1×10,5 W	EAN 4000870 798256 <b>798.25</b>
	<b>ø400 mm</b>
<b>W</b> 3.100 lm   incl. 1×22 W	EAN 4000870 798959 <b>new 798.95</b>
	<b>⇄595 ⇄595 mm</b>
<b>W</b> 2.650 lm   incl. 1×19,5 W	EAN 4000870 798263 <b>798.26</b>
	<b>⇄595 ⇄295 mm</b>
<b>W</b> 2.040 lm   incl. 1×15,5 W	EAN 4000870 798270 <b>798.27</b>

RGBW – W = 3.000 K

	<b>ø300 mm</b>
<b>W</b> 2.400 lm   incl. 1×16,5 W	EAN 4000870 798997 <b>new 798.99</b>
	<b>ø400 mm</b>
<b>W</b> 3.100 lm   incl. 1×22 W	EAN 4000870 798973 <b>new 798.97</b>

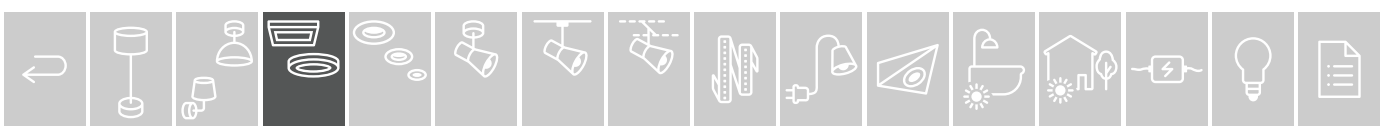



**Velora** Metal Metal Metallo 230V

white switch = 3.000 - 4.000 - 6.500 K



**ø300 mm**  
**W** 1.530 lm | incl. 1×13 W EAN 4000870 798928 **new 798.92**

**ø400 mm**  
**W** 2.130 lm | incl. 1×19 W EAN 4000870 798935 **new 798.93**

warm white = 3.000 K – 3 step dim



**↔225 ↗225 mm**  
**W** 1.500 lm | incl. 1×12 W EAN 4000870 798201 **798.20**

**↔295 ↗295 mm**  
**W** 2.100 lm | incl. 1×17 W EAN 4000870 798218 **798.21**

**↔595 ↗595 mm**  
**W** 4.400 lm | incl. 1×34 W EAN 4000870 798225 **798.22**

**↔595 ↗295 mm**  
**W** 3.300 lm | incl. 1×26 W EAN 4000870 798232 **798.23**

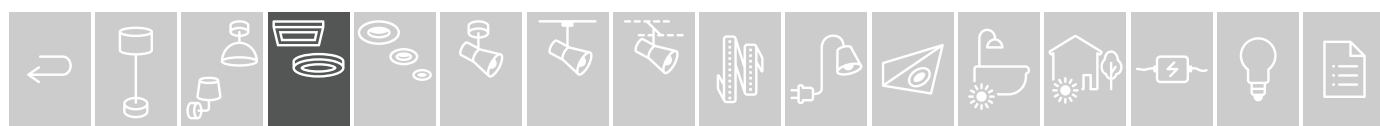



Velora

Metal Metal Metallo

230V

 warm white = 3.000K

↔225 ↗225 mm

<b>W</b>	1.480 lm		incl. 1×13 W	EAN 4000870 798164	<b>798.16</b>
----------	----------	--	--------------	--------------------	---------------

ø300 mm

<b>W</b>	1.500 lm		incl. 1×13 W	EAN 4000870 798904	<b>new 798.90</b>
----------	----------	--	--------------	--------------------	-------------------

↔300 ↗300 mm

<b>W</b>	1.860 lm		incl. 1×16,8 W	EAN 4000870 798171	<b>798.17</b>
----------	----------	--	----------------	--------------------	---------------

ø400 mm

<b>W</b>	2.100 lm		incl. 1×19 W	EAN 4000870 798911	<b>new 798.91</b>
----------	----------	--	--------------	--------------------	-------------------

↔600 ↗600 mm

<b>W</b>	4.270 lm		incl. 1×34,2 W	EAN 4000870 798188	<b>798.18</b>
----------	----------	--	----------------	--------------------	---------------

↔600 ↗300 mm

<b>W</b>	3.280 lm		incl. 1×29 W	EAN 4000870 798195	<b>798.19</b>
----------	----------	--	--------------	--------------------	---------------

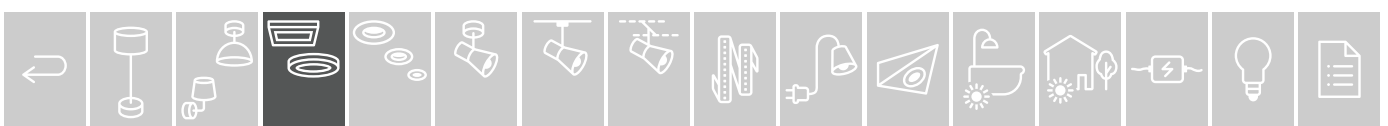

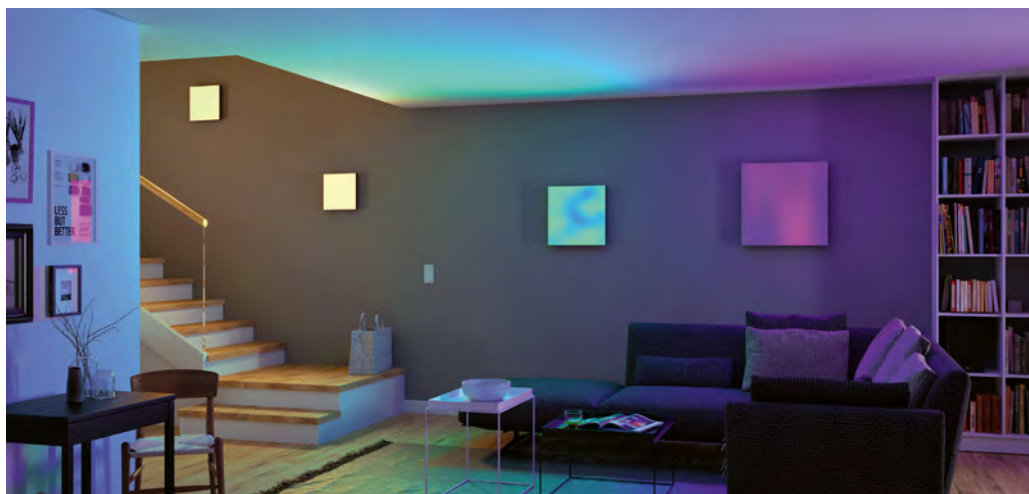

EN The speed of each lighting scene can be adjusted or frozen in a specific configuration.  
 ES Cada escena de luz se puede adaptar en su velocidad y congelar como imagen fija.  
 IT È possibile regolare la velocità di ogni scenografia luminosa e impostarne una come configurazione fissa.

- ▶ Velora Rainbow combines exceptional room lighting with magical colours for the best lighting properties with dynamic colour effects.
- ▶ The colour temperature is continuously adjustable between 3000 K to 6500 K via remote control, and there are 16 default light animations with dynamic colour control to choose from.
- ▶ Velora Rainbow is infinitely dimmable and has an integrated night light function.
- ▶ The high-quality matted light surface is integrated in an elegant, rimless floating frame.
- ▶ Velora Rainbow aún una excelente iluminación de interiores con una auténtica magia de colores, ya que crea cada vez nuevas combinaciones de las mejores características lumínicas con efectos de color dinámicos.
- ▶ Con el mando a distancia, se puede regular la temperatura de color sin escalonados entre 3000 K y 6500 K y ajustar 16 animaciones preconfiguradas con un control dinámico del color.
- ▶ Velora Rainbow es regulable sin escalonados y tiene una función de luz de noche integrada.
- ▶ La superficie luminosa mateada de alta calidad está integrada en un elegante marco flotante sin borde.
- ▶ Velora Rainbow unisce a un'eccezionale illuminazione degli spazi abitativi la più pura magia della luce, in quanto combina in modo completamente innovativo caratteristiche luminose ottimali ed effetti cromatici dinamici.
- ▶ Il telecomando consente di regolare in modo continuo la temperatura di colore da 3000 K a 6500 K e di impostare 16 animazioni predefinite, oltre a permettere un controllo dinamico del colore.
- ▶ Velora Rainbow è dimmerabile in continuo ed è dotato di una funzione luce notturna integrata.
- ▶ La superficie luminosa di alta qualità con effetto opaco è integrata in una cornice flutuante priva di bordi dalla grande eleganza.



**Velora Rainbow new**

☒ Metal Metal Metallo

230V

 RGBW – W = 3.000 - 6.500 K

↔295 ↻295 mm

<b>W</b>	1.420 lm	incl. 1x13,2W	EAN 4000870 799048	<b>799.04</b>
<b>B</b>	1.420 lm	incl. 1x13,2W	EAN 4000870 799079	<b>799.07</b>

↔450 ↻450 mm

<b>W</b>	2.110 lm	incl. 1x19W	EAN 4000870 799055	<b>799.05</b>
<b>B</b>	2.110 lm	incl. 1x19W	EAN 4000870 799086	<b>799.08</b>

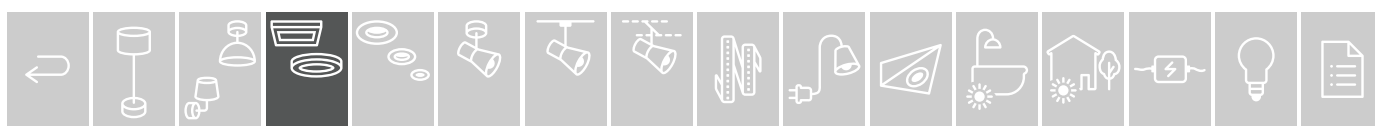





- ▶ Flat designs with an installation height of only 40 to 52 mm
- ▶ Can be controlled with the Smart Home ZigBee remote control or via the app
- ▶ Can still be switched on and off via light switch
- ▶ Modelos planos con una altura de montaje reducida de 40 a 52 mm
- ▶ Controlable con mando a distancia Smart Home ZigBee o a través de una aplicación
- ▶ Se mantiene la posibilidad de encendido y apagado a través del interruptor de luz
- ▶ Forme piatte con un'altezza di incasso da 40 a 52 cm
- ▶ Comandabile con telecomando Smart Home Zigbee o tramite app
- ▶ Accensione e spegnimento tramite l'interruttore



smart  
controllable  
**zigbee**



**Amaris** Metal Metal Metallo 230V

RGBW – W = 2.700 - 6.500 K

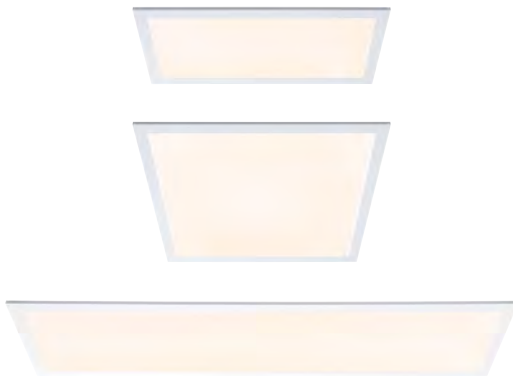

↔595 ↗295 mm

**W** 2.300 lm | incl. 1x20,2W EAN 4000870 798089 **798.08**

↔595 ↗595 mm

**W** 4.000 lm | incl. 1x35W EAN 4000870 798096 **798.09**

↔1.195 ↗295 mm

**W** 4.100 lm | incl. 1x38W EAN 4000870 798102 **798.10**

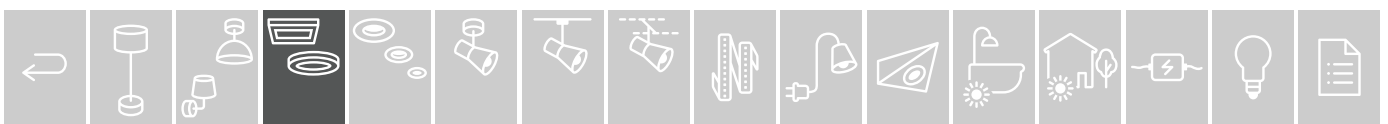



- ▶ The Atria Shine LED panel series includes a comprehensive range with state-of-the-art lighting technology and is ideal for basic lighting in living rooms, bedrooms and kitchens.
  - ▶ All luminaires in this series come equipped with modern backlight technology and have a very low installation height of just 28 mm. The resulting visual effect of the luminaires is modern, understated and almost as if floating on the wall or ceiling.
  - ▶ The Atria Shine series features a special twist lock, which makes the luminaires very easy to install.
  - ▶ In addition to switchable luminaires for neutral white and warm white light, models with incremental dimming via a light switch, or colour control via remote control are also available.
- ▶ La serie de paneles Atria Shine comprende una gama de productos completa con la tecnología de iluminación más moderna y es ideal como luz de fondo en la sala de estar, el dormitorio o la cocina.
  - ▶ Todas las luminarias de esta serie están equipadas con la moderna tecnología Backlight y tienen una altura de montaje muy reducida de solo 28 mm. De esta manera, las luminarias tienen un aspecto moderno y discreto y parecen flotar en la pared y el techo.
  - ▶ Además, la serie Atria Shine es muy fácil de montar gracias a su cierre giratorio especial.
  - ▶ Además de luminarias conmutables sencillamente con luz de color blanco neutro y blanco cálido, están disponibles unas variantes con regulación escalonada mediante el interruptor de luz o con control del color a través de un mando a distancia.
- ▶ La serie di pannelli Atria Shine comprende un'intera gamma delle più moderne tecnologie di illuminazione ed è ideale per l'illuminazione di base di soggiorni e camere da letto o cucine.
  - ▶ Tutte le lampade di questa serie sono dotate della moderna tecnologia Backlight e si contraddistinguono per il ridottissimo spessore di montaggio pari a 28 mm. Ciò conferisce a queste lampade un look moderno, discreto e con un effetto quasi oscillante su pareti e soffitti.
  - ▶ La serie Atria Shine è inoltre particolarmente semplice da montare grazie a una speciale chiusura rotante.
  - ▶ Oltre alle lampade a commutazione semplice con luce bianco neutro e bianco caldo, sono disponibili varianti con dimming a diversi livelli tramite interruttore o con comando dei colori mediante telecomando.

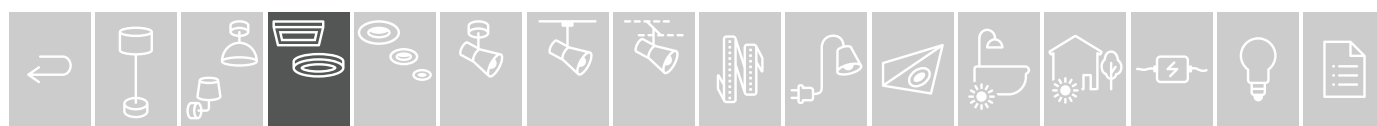

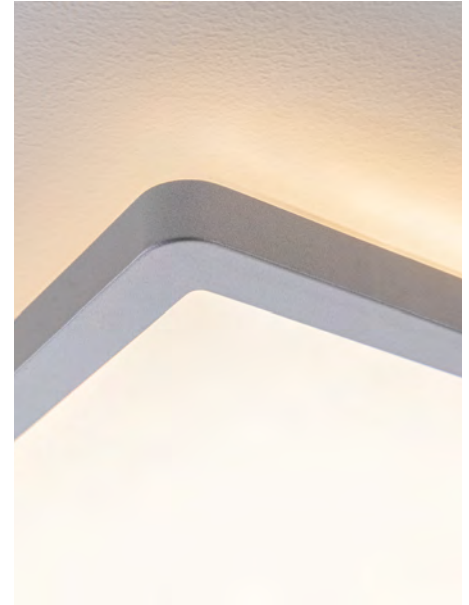

**Atria Shine new**

Plastic Plástico Plastica

230V



RGBW – W = 4.000 K



**ø293 mm**

**CM** 1.800 lm | incl. 1x12 W EAN 4000870 710180 **710.18**

**ø420 mm**

**CM** 2.800 lm | incl. 1x20 W EAN 4000870 710197 **710.19**

**↔580 ↗200 mm**

**CM** 2.800 lm | incl. 1x20 W EAN 4000870 710203 **710.20**





**Atrیا Shine new** Plastic Plástico Plastica 230V

warm white = 3.000 K – 3 step dim



ø420 mm

**CM** 2.800 lm | incl. 1x22 W EAN 4000870 709924 **709.92**

**B** 2.800 lm | incl. 1x22 W EAN 4000870 709993 **709.99**



↔420 ↗420 mm

**CM** 2.700 lm | incl. 1x22 W EAN 4000870 709955 **709.95**

**B** 2.700 lm | incl. 1x22 W EAN 4000870 710029 **710.02**



↔580 ↗200 mm

**CM** 2.700 lm | incl. 1x22 W EAN 4000870 709962 **709.96**

**B** 2.700 lm | incl. 1x22 W EAN 4000870 710036 **710.03**

neutral white = 4.000 K – 3 step dim



ø420 mm

**CM** 2.800 lm | incl. 1x22 W EAN 4000870 710067 **710.06**

**B** 2.800 lm | incl. 1x22 W EAN 4000870 710135 **710.13**



↔420 ↗420 mm

**CM** 2.700 lm | incl. 1x22 W EAN 4000870 710098 **710.09**

**B** 2.700 lm | incl. 1x22 W EAN 4000870 710166 **710.16**



↔580 ↗200 mm

**CM** 2.700 lm | incl. 1x22 W EAN 4000870 710104 **710.10**

**B** 2.700 lm | incl. 1x22 W EAN 4000870 710173 **710.17**

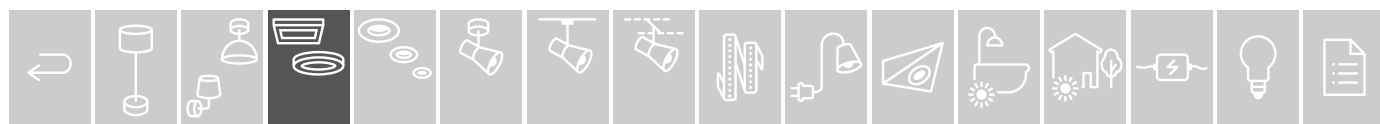

Atria Shine **new**

Plastic Plástico Plastica

230V

 warm white = 3.000 K

	ø190 mm				
	<b>CM</b>	1.340 lm	incl. 1×11,2 W	EAN 4000870 709900	<b>709.90</b>
	<b>B</b>	1.340 lm	incl. 1×11,2 W	EAN 4000870 709979	<b>709.97</b>
	⇄190 ⇄190 mm				
	<b>CM</b>	1.360 lm	incl. 1×11,2 W	EAN 4000870 709931	<b>709.93</b>
	<b>B</b>	1.360 lm	incl. 1×11,2 W	EAN 4000870 710005	<b>710.00</b>
	ø293 mm				
	<b>CM</b>	2.000 lm	incl. 1×16 W	EAN 4000870 709917	<b>709.91</b>
	<b>B</b>	2.000 lm	incl. 1×16 W	EAN 4000870 709986	<b>709.98</b>
	⇄293 ⇄293 mm				
	<b>CM</b>	2.000 lm	incl. 1×16 W	EAN 4000870 709948	<b>709.94</b>
	<b>B</b>	2.000 lm	incl. 1×16 W	EAN 4000870 710012	<b>710.01</b>

 neutral white = 4.000 K









	ø190 mm				
	<b>CM</b>	1.340 lm	incl. 1×11,2 W	EAN 4000870 710043	<b>710.04</b>
	<b>B</b>	1.340 lm	incl. 1×11,2 W	EAN 4000870 710111	<b>710.11</b>
	⇄190 ⇄190 mm				
	<b>CM</b>	1.360 lm	incl. 1×11,2 W	EAN 4000870 710074	<b>710.07</b>
	<b>B</b>	1.360 lm	incl. 1×11,2 W	EAN 4000870 710142	<b>710.14</b>
	ø293 mm				
	<b>CM</b>	2.000 lm	incl. 1×16 W	EAN 4000870 710050	<b>710.05</b>
	<b>B</b>	2.000 lm	incl. 1×16 W	EAN 4000870 710128	<b>710.12</b>
	⇄293 ⇄293 mm				
	<b>CM</b>	2.000 lm	incl. 1×16 W	EAN 4000870 710081	<b>710.08</b>
	<b>B</b>	2.000 lm	incl. 1×16 W	EAN 4000870 710159	<b>710.15</b>









**Atria** Plastic Plástico Plastica 230V

warm white = 2.700 K – dimmable

	<b>ø220 mm</b>			
	<b>⇔220 ↗220 mm</b>			
	<b>ø300 mm</b>			
	<b>⇔300 ↗300 mm</b>			
	<b>ø220 mm</b>			
	<b>⇔220 ↗220 mm</b>			
	<b>ø300 mm</b>			
	<b>⇔300 ↗300 mm</b>			
	<b>W</b>	1.500 lm   incl. 1×14 W	EAN 4000870 708682	<b>708.68</b>
	<b>CM</b>	1.500 lm   incl. 1×14 W	EAN 4000870 708644	<b>708.64</b>
	<b>W</b>	1.500 lm   incl. 1×14 W	EAN 4000870 708705	<b>708.70</b>
	<b>CM</b>	1.500 lm   incl. 1×14 W	EAN 4000870 708668	<b>708.66</b>
	<b>W</b>	1.800 lm   incl. 1×16 W	EAN 4000870 708699	<b>708.69</b>
	<b>CM</b>	1.800 lm   incl. 1×16 W	EAN 4000870 708651	<b>708.65</b>
	<b>RG</b>	1.800 lm   incl. 1×16 W	EAN 4000870 708729	<b>708.72</b>
	<b>W</b>	1.800 lm   incl. 1×16,5 W	EAN 4000870 708712	<b>708.71</b>
	<b>CM</b>	1.800 lm   incl. 1×16,5 W	EAN 4000870 708675	<b>708.67</b>
	<b>RG</b>	1.800 lm   incl. 1×16,5 W	EAN 4000870 708736	<b>708.73</b>

neutral white = 4.000 K

	<b>ø220 mm</b>			
	<b>⇔220 ↗220 mm</b>			
	<b>ø300 mm</b>			
	<b>⇔300 ↗300 mm</b>			
	<b>W</b>	1.500 lm   incl. 1×14 W	EAN 4000870 709375	<b>709.37</b>
	<b>CM</b>	1.500 lm   incl. 1×14 W	EAN 4000870 709337	<b>709.33</b>
	<b>CM</b>	1.500 lm   incl. 1×14 W	EAN 4000870 709351	<b>709.35</b>
	<b>W</b>	1.500 lm   incl. 1×14 W	EAN 4000870 709382	<b>709.38</b>
	<b>CM</b>	1.800 lm   incl. 1×16 W	EAN 4000870 709344	<b>709.34</b>
	<b>RG</b>	1.800 lm   incl. 1×16 W	EAN 4000870 709405	<b>709.40</b>
	<b>CM</b>	1.800 lm   incl. 1×16,5 W	EAN 4000870 709368	<b>709.36</b>
	<b>W</b>	1.800 lm   incl. 1×16,5 W	EAN 4000870 709399	<b>709.39</b>
	<b>RG</b>	1.800 lm   incl. 1×20 W	EAN 4000870 709412	<b>709.41</b>

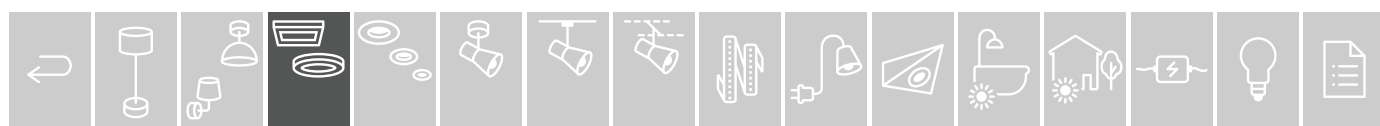



**Lunar** Aluminium Aluminio Alluminio 230V

● warm white = 3.000K



**ø170 mm**

<b>W</b>	1.230 lm		incl. 1×11 W	EAN 4000870 706411	<b>706.41</b>
<b>CM</b>	1.230 lm		incl. 1×11 W	EAN 4000870 706534	<b>706.53</b>



**⇔170 ↗170 mm**

<b>W</b>	1.230 lm		incl. 1×11 W	EAN 4000870 706442	<b>706.44</b>
<b>CM</b>	1.230 lm		incl. 1×11 W	EAN 4000870 706480	<b>706.48</b>



**ø225 mm**

<b>W</b>	1.520 lm		incl. 1×12,5 W	EAN 4000870 706428	<b>706.42</b>
<b>CM</b>	1.520 lm		incl. 1×12,5 W	EAN 4000870 706541	<b>706.54</b>



**⇔225 ↗225 mm**

<b>W</b>	1.520 lm		incl. 1×12,5 W	EAN 4000870 706459	<b>706.45</b>
<b>CM</b>	1.520 lm		incl. 1×12,5 W	EAN 4000870 706497	<b>706.49</b>



**ø300 mm**

<b>W</b>	1.700 lm		incl. 1×16 W	EAN 4000870 706435	<b>706.43</b>
<b>CM</b>	1.700 lm		incl. 1×16 W	EAN 4000870 706558	<b>706.55</b>

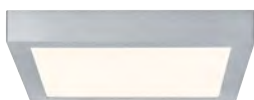

**⇔300 ↗300 mm**

<b>W</b>	1.950 lm		incl. 1×16 W	EAN 4000870 706466	<b>706.46</b>
<b>CM</b>	1.886 lm		incl. 1×16 W	EAN 4000870 706503	<b>706.50</b>



**ø400 mm**

<b>CM</b>	2.600 lm		incl. 1×22 W	EAN 4000870 706565	<b>706.56</b>
-----------	----------	--	--------------	--------------------	---------------



**⇔400 ↗400 mm**

<b>CM</b>	2.400 lm		incl. 1×22 W	EAN 4000870 706510	<b>706.51</b>
-----------	----------	--	--------------	--------------------	---------------



**⇔600 ↗600 mm**

<b>W</b>	3.200 lm		incl. 1×25 W	EAN 4000870 706473	<b>706.47</b>
<b>CM</b>	3.050 lm		incl. 1×25 W	EAN 4000870 706527	<b>706.52</b>

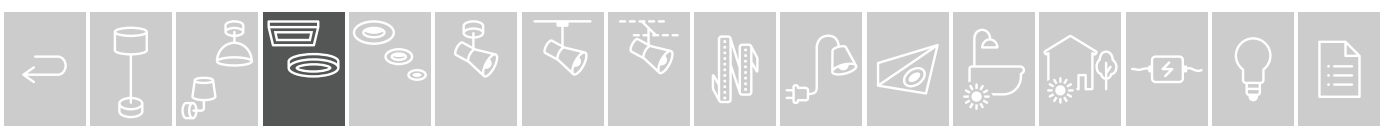



**Abia** Plastic Plástico Plastica 230V

● warm white = 2.700 K



ø300 mm

<b>W</b>	3.200 lm		incl. 1x22 W	EAN 4000870 708996	<b>708.99</b>
<b>CM</b>	3.200 lm		incl. 1x22 W	EAN 4000870 709832	<b>709.83</b>
<b>B</b>	3.200 lm		incl. 1x22 W	EAN 4000870 709849	<b>709.84</b>



⇄300 ⇄300 mm

<b>W</b>	3.200 lm		incl. 1x22 W	EAN 4000870 709009	<b>709.00</b>
<b>CM</b>	3.200 lm		incl. 1x22 W	EAN 4000870 709825	<b>709.82</b>
<b>B</b>	3.200 lm		incl. 1x22 W	EAN 4000870 709856	<b>709.85</b>







**Abia new** Plastic Plástico Plastica 230V

● warm white = 2.700 K

ø300 mm



<b>L</b>	3.200 lm		incl. 1x22 W	EAN 4000870 709894	<b>709.89</b>
<b>DG</b>	3.200 lm		incl. 1x22 W	EAN 4000870 709887	<b>709.88</b>
<b>MB</b>	3.200 lm		incl. 1x22 W	EAN 4000870 709863	<b>709.86</b>
<b>PB</b>	3.200 lm		incl. 1x22 W	EAN 4000870 709870	<b>709.87</b>



**Aviar** Plastic Plástico Plastica 230V

● ● warm white = 3.000 K – dimmable

ø220 mm



<b>C</b>	1.400 lm		incl. 1x12,6 W	EAN 4000870 789216	<b>789.21</b>
<b>W</b>	1.400 lm		incl. 1x12,6 W	EAN 4000870 789230	<b>789.23</b>

○ ● neutral white = 4.000 K – dimmable

ø220 mm



<b>C</b>	1.300 lm		incl. 1x12,7 W	EAN 4000870 789223	<b>789.22</b>
----------	----------	--	----------------	--------------------	---------------







☑=105 Nova mini



Choose! ☑=106

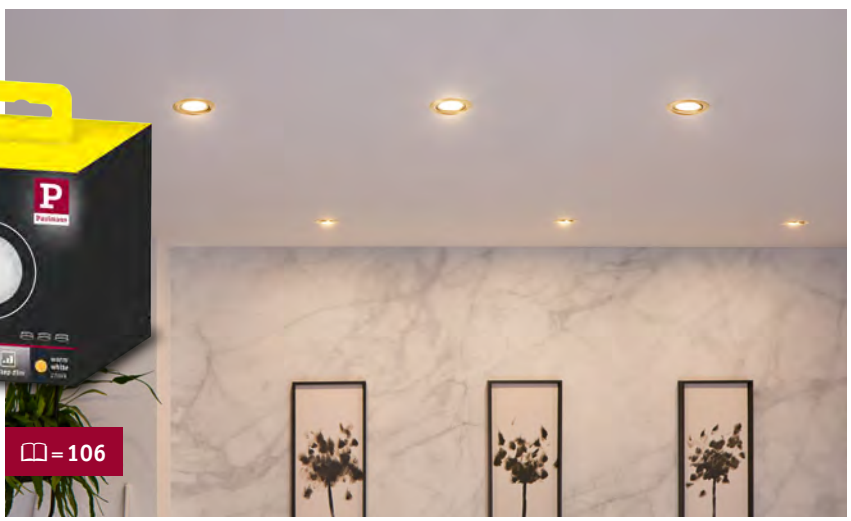

Decorative ☑=119



☑=124 Panels

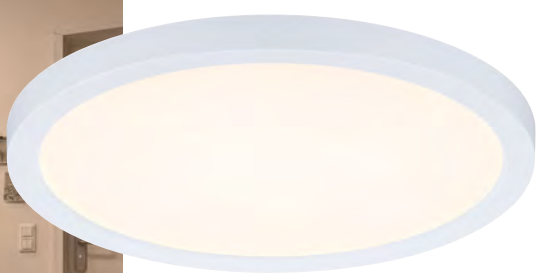

Easy to Shop – Paulmann Recessed Luminaire Range  
 Easy to Shop – Surtido de luminarias empotradas Paulmann  
 Easy to Shop – L'assortimento di faretti a incasso Paulmann

□□=91		□□=92-95		□□=96-102				
<b>Base</b>		<b>Nova</b>		<b>Nova Plus</b>				
 <b>IP23</b> Swivelling Orientable Orientabili		 <b>IP23</b> Swivelling Orientable Orientabili		 <b>IP44</b> Rigid Rígida Fissi		 <b>IP23</b> Swivelling Orientable Orientabili	 <b>IP65</b> Rigid Rígida Fissi	 <b>IP65</b> Swivelling Orientable Zwenkbaar
 <b>COIN GU10</b>		 <b>COIN GU10</b>		 <b>COIN GU10</b>		 <b>COIN</b>	 <b>COIN</b>	 <b>COIN GU10</b>
 <b>3 step dim</b>		 <b>3 step dim</b>		 <b>3 step dim</b>		 <b>dimmable</b>	 <b>dimmable</b>	 <b>dimmable</b>
 <b>COIN GU10</b>  No dimming		 <b>COIN GU10</b>  No dimming		 <b>COIN GU10</b>  No dimming		 □□=103 smart controllable  <b>zigbee</b>		
 <b>3000 K</b>		 <b>2700 K</b>		 <b>2700 K</b>		 <b>dimmable</b>	 <b>tunable white</b>	 <b>RGBW</b>
 Metal Metal Metallo		 Aluminium Aluminio Alluminio		 Aluminium Aluminio Alluminio				

 <b>dimmable</b>	Infinitely dimmable Regulable sin escalonados Con dimming continuo	 <b>3 step dim</b>	 100% 50% 25% off	 Dimmable in steps with wall switch Regulable de forma escalonada con interruptor de pared Con dimming a livelli tramite interruttore a parete
---------------------	--	-----------------------	-------------------------------	---

					<b>Sets</b>
Safe connection, without transformer Conexión segura, sin transformador Collegamento sicuro senza trasformatore	Link up any number of luminaires via the connection box supplied Concatenable sin limitaciones con caja de conexión incluida Applicazione illimitata con scatola di collegamento compresa	Standard 68 mm bore diameter Diámetro de taladro estándar 68 mm Diametro foro standard 68 mm	Retaining springs for easy installation and removal Resortes de sujeción para facilitar el montaje y desmontaje Molle per facilitare montaggio e smontaggio	With replaceable lamp Con lámpara reemplazable Con lampadine sostituibili	3-piece set is sufficient for 12 m <sup>2</sup> -15 m <sup>2</sup> Basic lighting Juego de 3 unidades para 12 m <sup>2</sup> -15 m <sup>2</sup> como luz de fondo Un set da 3 è sufficiente per un'illuminazione di base da 12m <sup>2</sup> -15m <sup>2</sup>

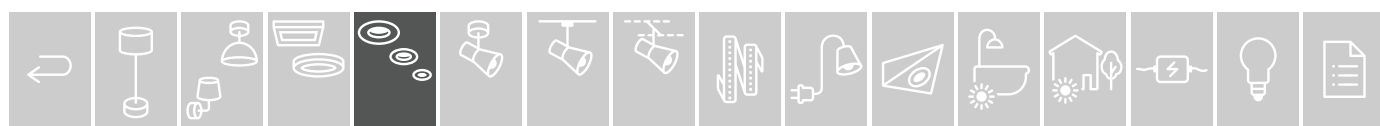

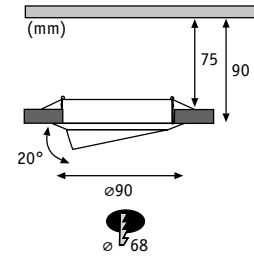

Base LED GU10 230V

Metal Metal Metallo

White Blanco Bianco



incl. 1x4,6 W | 410 lm | GU10 | 3.000 K |  $\sphericalangle$ 38° | EAN 4000870 934111 **934.11**

incl. 3x4,6 W | 3x410 lm | GU10 | 3.000 K |  $\sphericalangle$ 38° | EAN 4000870 934227 **934.22**

incl. 3x5 W | 3x350 lm | GU10 | 3.000 K |  $\sphericalangle$ 38° | EAN 4000870 934265 **934.26**

Brushed iron Hierro mateado Ferro spazzolato



incl. 1x4,6 W | 410 lm | GU10 | 3.000 K |  $\sphericalangle$ 38° | EAN 4000870 934128 **934.12**

incl. 3x4,6 W | 3x410 lm | GU10 | 3.000 K |  $\sphericalangle$ 38° | EAN 4000870 934203 **934.20**

incl. 3x5 W | 3x350 lm | GU10 | 3.000 K |  $\sphericalangle$ 38° | EAN 4000870 934241 **934.24**

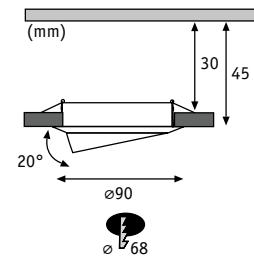

Base LED Coin 230V

Metal Metal Metallo

White Blanco Bianco



incl. 1x5 W | 370 lm | Coin | 3.000 K |  $\sphericalangle$ 100° | EAN 4000870 934135 **934.13**

incl. 3x5 W | 3x370 lm | Coin | 3.000 K |  $\sphericalangle$ 100° | EAN 4000870 934234 **934.23**

incl. 3x5 W | 3x370 lm | Coin | 3.000 K |  $\sphericalangle$ 100° | EAN 4000870 934272 **934.27**

Brushed iron Hierro mateado Ferro spazzolato



incl. 1x5 W | 370 lm | Coin | 3.000 K |  $\sphericalangle$ 100° | EAN 4000870 934142 **934.14**

incl. 3x5 W | 3x370 lm | Coin | 3.000 K |  $\sphericalangle$ 100° | EAN 4000870 934210 **934.21**

incl. 3x5 W | 3x370 lm | Coin | 3.000 K |  $\sphericalangle$ 100° | EAN 4000870 934258 **934.25**



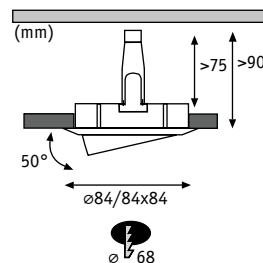

**Nova LED GU10 230V**

Aluminium Aluminio Alluminio

**Matt white Blanco mate Bianco opaco**



incl. 1x6,5W | 460 lm | GU10 | 2.700 K |  $\sphericalangle$ 38° | EAN 4000870 934302 | **934.30**

incl. 3x6,5W | 3x460 lm | GU10 | 2.700 K |  $\sphericalangle$ 38° | EAN 4000870 934319 | **934.31**



incl. 1x6,5W | 460 lm | GU10 | 2.700 K |  $\sphericalangle$ 38° | EAN 4000870 934661 | **934.66**



incl. 3x6,5W | 3x460 lm | GU10 | 2.700 K |  $\sphericalangle$ 38° | EAN 4000870 934678 | **934.67**



incl. 1x6,5W | 460 lm | GU10 | 2.700 K |  $\sphericalangle$ 38° | EAN 4000870 934357 | **934.35**

incl. 3x6,5W | 3x460 lm | GU10 | 2.700 K |  $\sphericalangle$ 38° | EAN 4000870 934364 | **934.36**



incl. 1x6,5W | 460 lm | GU10 | 2.700 K |  $\sphericalangle$ 38° | EAN 4000870 934715 | **934.71**



incl. 3x6,5W | 3x460 lm | GU10 | 2.700 K |  $\sphericalangle$ 38° | EAN 4000870 934722 | **934.72**

**Brushed iron Hierro mateado Ferro spazzolato**



incl. 1x6,5W | 460 lm | GU10 | 2.700 K |  $\sphericalangle$ 38° | EAN 4000870 934289 | **934.28**

incl. 3x6,5W | 3x460 lm | GU10 | 2.700 K |  $\sphericalangle$ 38° | EAN 4000870 934296 | **934.29**



incl. 1x6,5W | 460 lm | GU10 | 2.700 K |  $\sphericalangle$ 38° | EAN 4000870 934647 | **934.64**



incl. 3x6,5W | 3x460 lm | GU10 | 2.700 K |  $\sphericalangle$ 38° | EAN 4000870 934654 | **934.65**

**Chrome Cromo Cromo**



incl. 3x6,5W | 3x460 lm | GU10 | 2.700 K |  $\sphericalangle$ 38° | EAN 4000870 934340 | **934.34**



incl. 3x6,5W | 3x460 lm | GU10 | 2.700 K |  $\sphericalangle$ 38° | EAN 4000870 934708 | **934.70**

**Turned aluminium Aluminio torneado Alluminio tornito**



incl. 1x6,5W | 460 lm | GU10 | 2.700 K |  $\sphericalangle$ 38° | EAN 4000870 934326 | **934.32**

incl. 3x6,5W | 3x460 lm | GU10 | 2.700 K |  $\sphericalangle$ 38° | EAN 4000870 934333 | **934.33**



incl. 1x6,5W | 460 lm | GU10 | 2.700 K |  $\sphericalangle$ 38° | EAN 4000870 934685 | **934.68**



incl. 3x6,5W | 3x460 lm | GU10 | 2.700 K |  $\sphericalangle$ 38° | EAN 4000870 934692 | **934.69**



incl. 1x6,5W | 460 lm | GU10 | 2.700 K |  $\sphericalangle$ 38° | EAN 4000870 934371 | **934.37**

incl. 3x6,5W | 3x460 lm | GU10 | 2.700 K |  $\sphericalangle$ 38° | EAN 4000870 934388 | **934.38**



incl. 1x6,5W | 460 lm | GU10 | 2.700 K |  $\sphericalangle$ 38° | EAN 4000870 934739 | **934.73**



incl. 3x6,5W | 3x460 lm | GU10 | 2.700 K |  $\sphericalangle$ 38° | EAN 4000870 934746 | **934.74**

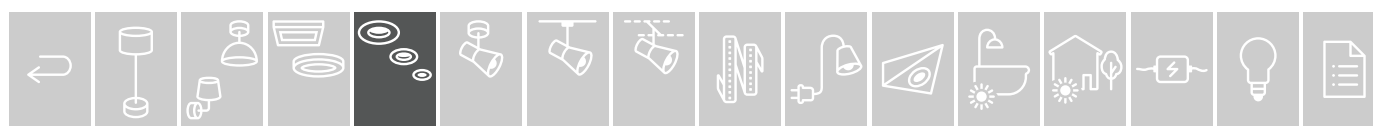

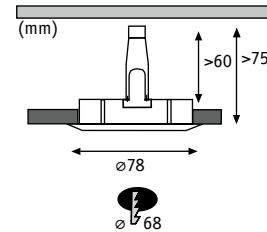

**Nova LED GU10 4000K**

Aluminium zinc Aluminio cinc Alluminio zincato

**Matt white Blanco mate Bianco opaco**



	incl. 1x6 W		470 lm		GU10		4.000 K		36°		EAN 4000870 929780		<b>929.78</b>
	incl. 3x6 W		3x470 lm		GU10		4.000 K		36°		EAN 4000870 929803		<b>929.80</b>
	incl. 1x6 W		470 lm		GU10		4.000 K		36°		EAN 4000870 929827		<b>929.82</b>
	incl. 3x6 W		3x470 lm		GU10		4.000 K		36°		EAN 4000870 929841		<b>929.84</b>
	incl. 1x6 W		470 lm		GU10		2.700 K		38°		EAN 4000870 934418		<b>934.41</b>
	incl. 3x6 W		3x470 lm		GU10		2.700 K		38°		EAN 4000870 934425		<b>934.42</b>
	incl. 1x6 W		470 lm		GU10		2.700 K		38°		EAN 4000870 934777		<b>934.77</b>
	incl. 3x6 W		3x470 lm		GU10		2.700 K		38°		EAN 4000870 934784		<b>934.78</b>

**Brushed iron Hierro mateado Ferro spazzolato**



	incl. 1x6 W		470 lm		GU10		4.000 K		36°		EAN 4000870 929773		<b>929.77</b>
	incl. 3x6 W		3x470 lm		GU10		4.000 K		36°		EAN 4000870 929797		<b>929.79</b>
	incl. 1x6 W		470 lm		GU10		4.000 K		36°		EAN 4000870 929810		<b>929.81</b>
	incl. 3x6 W		3x470 lm		GU10		4.000 K		36°		EAN 4000870 929834		<b>929.83</b>
	incl. 1x6 W		470 lm		GU10		2.700 K		38°		EAN 4000870 934395		<b>934.39</b>
	incl. 3x6 W		3x470 lm		GU10		2.700 K		38°		EAN 4000870 934401		<b>934.40</b>
	incl. 1x6 W		470 lm		GU10		2.700 K		38°		EAN 4000870 934753		<b>934.75</b>
	incl. 3x6 W		3x470 lm		GU10		2.700 K		38°		EAN 4000870 934760		<b>934.76</b>

**Chrome Cromo Cromo**



	incl. 3x6 W		3x470 lm		GU10		2.700 K		38°		EAN 4000870 934456		<b>934.45</b>
	incl. 3x6 W		3x470 lm		GU10		2.700 K		38°		EAN 4000870 934814		<b>934.81</b>

**Turned aluminium Aluminio torneado Alluminio tornito**



	incl. 1x6 W		470 lm		GU10		2.700 K		38°		EAN 4000870 934432		<b>934.43</b>
	incl. 3x6 W		3x470 lm		GU10		2.700 K		38°		EAN 4000870 934449		<b>934.44</b>
	incl. 1x6 W		470 lm		GU10		2.700 K		38°		EAN 4000870 934791		<b>934.79</b>
	incl. 3x6 W		3x470 lm		GU10		2.700 K		38°		EAN 4000870 934807		<b>934.80</b>



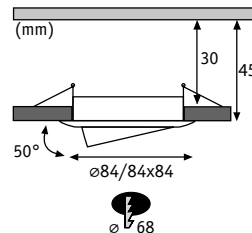

Nova LED Coin 230V

Aluminium Aluminio Alluminio

**Matt white Blanco mate Bianco opaco**

	incl. 1x6 W	470 lm	Coin	2.700 K	◊100°	EAN 4000870 934487	<b>934.48</b>
	incl. 3x6 W	3x470 lm	Coin	2.700 K	◊100°	EAN 4000870 934494	<b>934.49</b>
	incl. 1x6 W	470 lm	Coin	2.700 K	◊100°	EAN 4000870 934845	<b>934.84</b>
	incl. 3x6 W	3x470 lm	Coin	2.700 K	◊100°	EAN 4000870 934852	<b>934.85</b>
	incl. 1x6 W	470 lm	Coin	2.700 K	◊100°	EAN 4000870 934531	<b>934.53</b>
	incl. 3x6 W	3x470 lm	Coin	2.700 K	◊100°	EAN 4000870 934548	<b>934.54</b>
	incl. 1x6 W	470 lm	Coin	2.700 K	◊100°	EAN 4000870 934890	<b>934.89</b>
	incl. 3x6 W	3x470 lm	Coin	2.700 K	◊100°	EAN 4000870 934906	<b>934.90</b>

**Brushed iron Hierro mateado Ferro spazzolato**

	incl. 1x6 W	470 lm	Coin	2.700 K	◊100°	EAN 4000870 934463	<b>934.46</b>
	incl. 3x6 W	3x470 lm	Coin	2.700 K	◊100°	EAN 4000870 934470	<b>934.47</b>
	incl. 1x6 W	470 lm	Coin	2.700 K	◊100°	EAN 4000870 934821	<b>934.82</b>
	incl. 3x6 W	3x470 lm	Coin	2.700 K	◊100°	EAN 4000870 934838	<b>934.83</b>

**Chrome Cromo Cromo**

	incl. 3x6 W	3x470 lm	Coin	2.700 K	◊100°	EAN 4000870 934524	<b>934.52</b>
	incl. 3x6 W	3x470 lm	Coin	2.700 K	◊100°	EAN 4000870 934883	<b>934.88</b>

**Turned aluminium Aluminio torneado Alluminio tornito**

	incl. 1x6 W	470 lm	Coin	2.700 K	◊100°	EAN 4000870 934500	<b>934.50</b>
	incl. 3x6 W	3x470 lm	Coin	2.700 K	◊100°	EAN 4000870 934517	<b>934.51</b>
	incl. 1x6 W	470 lm	Coin	2.700 K	◊100°	EAN 4000870 934869	<b>934.86</b>
	incl. 3x6 W	3x470 lm	Coin	2.700 K	◊100°	EAN 4000870 934876	<b>934.87</b>
	incl. 1x6 W	470 lm	Coin	2.700 K	◊100°	EAN 4000870 934555	<b>934.55</b>
	incl. 3x6 W	3x470 lm	Coin	2.700 K	◊100°	EAN 4000870 934562	<b>934.56</b>
	incl. 1x6 W	470 lm	Coin	2.700 K	◊100°	EAN 4000870 934913	<b>934.91</b>
	incl. 3x6 W	3x470 lm	Coin	2.700 K	◊100°	EAN 4000870 934920	<b>934.92</b>

**Black matt Negro mate Nero opaco**

	incl. 3x6 W	3x470 lm	Coin	2.700 K	◊100°	EAN 4000870 944714	<b>944.71</b>
	incl. 3x6 W	3x470 lm	Coin	2.700 K	◊100°	EAN 4000870 944721	<b>944.72</b>

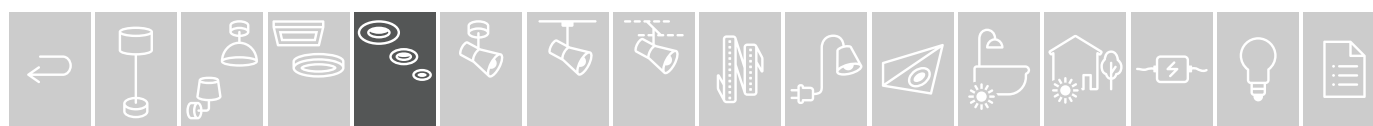



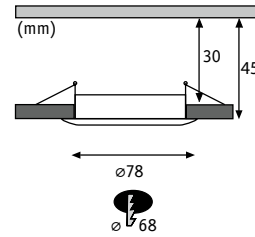

**Nova LED Coin 230V**

Aluminium Aluminio Alluminio

**Matt white Blanco mate Bianco opaco**



incl. 1x6 W		470 lm		Coin		2.700 K		⊘100°		EAN 4000870 934593	<b>934.59</b>
incl. 3x6 W		3x470 lm		Coin		2.700 K		⊘100°		EAN 4000870 934609	<b>934.60</b>
incl. 1x6 W		470 lm		Coin		2.700 K		⊘100°		EAN 4000870 934951	<b>934.95</b>
incl. 3x6 W		3x470 lm		Coin		2.700 K		⊘100°		EAN 4000870 934968	<b>934.96</b>

**Brushed iron Hierro mateado Ferro spazzolato**



incl. 1x6 W		470 lm		Coin		2.700 K		⊘100°		EAN 4000870 934579	<b>934.57</b>
incl. 3x6 W		3x470 lm		Coin		2.700 K		⊘100°		EAN 4000870 934586	<b>934.58</b>
incl. 1x6 W		470 lm		Coin		2.700 K		⊘100°		EAN 4000870 934937	<b>934.93</b>
incl. 3x6 W		3x470 lm		Coin		2.700 K		⊘100°		EAN 4000870 934944	<b>934.94</b>

**Chrome Cromo Cromo**



incl. 3x6 W		3x470 lm		Coin		2.700 K		⊘100°		EAN 4000870 934630	<b>934.63</b>
incl. 3x6 W		3x470 lm		Coin		2.700 K		⊘100°		EAN 4000870 934999	<b>934.99</b>

**Turned aluminium Aluminio torneado Alluminio tornito**



incl. 1x6 W		470 lm		Coin		2.700 K		⊘100°		EAN 4000870 934616	<b>934.61</b>
incl. 3x6 W		3x470 lm		Coin		2.700 K		⊘100°		EAN 4000870 934623	<b>934.62</b>
incl. 1x6 W		470 lm		Coin		2.700 K		⊘100°		EAN 4000870 934975	<b>934.97</b>
incl. 3x6 W		3x470 lm		Coin		2.700 K		⊘100°		EAN 4000870 934982	<b>934.98</b>

**Black matt Negro mate Nero opaco**



incl. 3x6 W		3x470 lm		Coin		2.700 K		⊘100°		EAN 4000870 944738	<b>944.73</b>
incl. 3x6 W		3x470 lm		Coin		2.700 K		⊘100°		EAN 4000870 944745	<b>944.74</b>



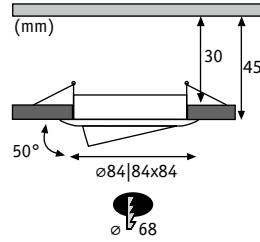

**LED 230V Slim Coin Satin 51mm dimmable**

Aluminium zinc / Aluminio cinc / Alluminio zincato

- ▶ Shallow installation depth
- ▶ Incl. junction box with double quick clamp for feeding through wires
- ▶ Mínima profundidad de empotre
- ▶ Incluye caja de conexión con conector rápido doble para paso de cable
- ▶ Profondità minima di incasso ridotta
- ▶ Scatola di connessione con clip rapida doppia per il passaggio dei cavi

**Matt white Blanco mate Bianco opaco**



	incl. 1x6 W		470 lm		Coin		2.700 K	EAN 4000870 938768		<b>938.76</b>
	incl. 3x6 W		3x470 lm		Coin		2.700 K	EAN 4000870 938751		<b>938.75</b>
	incl. 1x6 W		470 lm		Coin		2.700 K	EAN 4000870 936771		<b>936.77</b>
	incl. 3x6 W		3x470 lm		Coin		2.700 K	EAN 4000870 936788		<b>936.78</b>

**Brushed iron Hierro mateado Ferro spazzolato**



	incl. 1x6 W		470 lm		Coin		2.700 K	EAN 4000870 938775		<b>938.77</b>
	incl. 3x6 W		3x470 lm		Coin		2.700 K	EAN 4000870 938782		<b>938.78</b>

**Chrome Cromo Cromo**



	incl. 1x6 W		470 lm		Coin		2.700 K	EAN 4000870 938799		<b>938.79</b>
	incl. 3x6 W		3x470 lm		Coin		2.700 K	EAN 4000870 938805		<b>938.80</b>

**Turned aluminium Aluminio torneado Alluminio tornito**



	incl. 1x6 W		470 lm		Coin		2.700 K	EAN 4000870 939024		<b>939.02</b>
	incl. 3x6 W		3x470 lm		Coin		2.700 K	EAN 4000870 939031		<b>939.03</b>
	incl. 1x6 W		470 lm		Coin		2.700 K	EAN 4000870 936795		<b>936.79</b>
	incl. 3x6 W		3x470 lm		Coin		2.700 K	EAN 4000870 936801		<b>936.80</b>



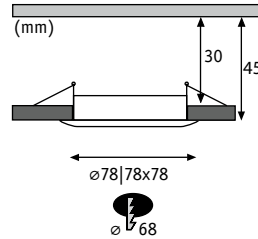

**LED 230V Slim Coin Satin 51mm dimmable**

Aluminium zinc / Aluminio cinc / Alluminio zincato

- ▶ Shallow installation depth
- ▶ Incl. junction box with double quick clamp for feeding through wires
- ▶ Mínima profundidad de empotre
- ▶ Incluye caja de conexión con conector rápido doble para paso de cable
- ▶ Profondità minima di incasso ridotta
- ▶ Scatola di connessione con clip rapida doppia per il passaggio dei cavi

**Matt white Blanco mate Bianco opaco**



	incl. 1x6 W		470 lm		Coin		2.700 K		EAN 4000870 938690	<b>938.69</b>
	incl. 3x6 W		3x470 lm		Coin		2.700 K		EAN 4000870 938706	<b>938.70</b>

**Brushed iron Hierro mateado Ferro spazzolato**



	incl. 1x6 W		470 lm		Coin		2.700 K		EAN 4000870 938713	<b>938.71</b>
	incl. 3x6 W		3x470 lm		Coin		2.700 K		EAN 4000870 938737	<b>938.73</b>

**Chrome Cromo Cromo**



	incl. 1x6 W		470 lm		Coin		2.700 K		EAN 4000870 938720	<b>938.72</b>
	incl. 3x6 W		3x470 lm		Coin		2.700 K		EAN 4000870 938744	<b>938.74</b>

**Turned aluminium Aluminio torneado Alluminio tornito**



	incl. 1x6 W		470 lm		Coin		2.700 K		EAN 4000870 939000	<b>939.00</b>
	incl. 3x6 W		3x470 lm		Coin		2.700 K		EAN 4000870 939017	<b>939.01</b>



	incl. 3x6 W		3x470 lm		Coin		2.700 K		EAN 4000870 938959	<b>938.95</b>
--	-------------	--	----------	--	------	--	---------	--	--------------------	---------------



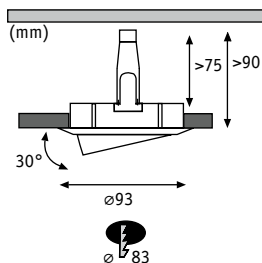

**Nova IP65 adjustable GU10 dimmable**

Aluminium zinc / Aluminio cinc / Alluminio zincato

**Matt white Blanco mate Bianco opaco**



	incl. 1x6 W		470 lm		GU10		2.700 K		36°	EAN 4000870 928974		<b>928.97</b>
	incl. 3x6 W		3x470 lm		GU10		2.700 K		36°	EAN 4000870 928981		<b>928.98</b>

**Brushed iron Hierro mateado Ferro spazzolato**



	incl. 1x6 W		470 lm		GU10		2.700 K		36°	EAN 4000870 928998		<b>928.99</b>
	incl. 3x6 W		3x470 lm		GU10		2.700 K		36°	EAN 4000870 929001		<b>929.00</b>

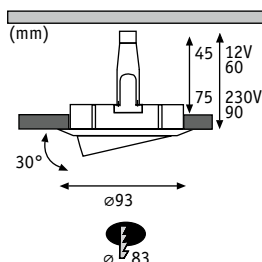

**Nova IP65 adjustable GU10/GU5,3**

Aluminium zinc / Aluminio cinc / Alluminio zincato

**Matt white Blanco mate Bianco opaco**



max. 35 W		GU5,3 / GU10	EAN 4000870 936610	<b>936.61</b>
-----------	--	--------------	--------------------	---------------

**Brushed iron Hierro mateado Ferro spazzolato**



max. 35 W		GU5,3 / GU10	EAN 4000870 936627	<b>936.62</b>
-----------	--	--------------	--------------------	---------------

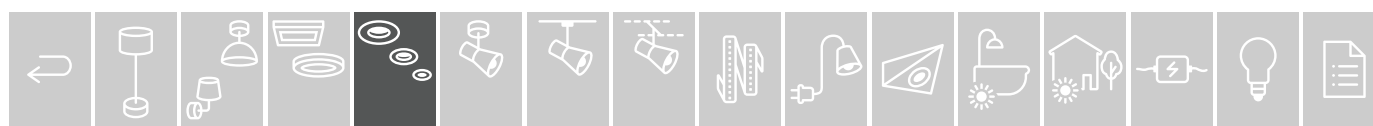

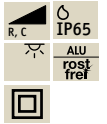
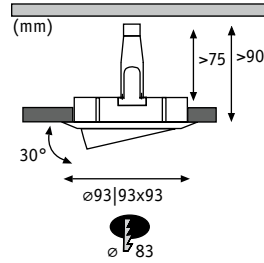

**Nova IP65 adjustable GU10 dimmable**

Aluminium zinc / Aluminio cinc / Alluminio zincato

- ▶ Protected from spray water and water jets (IP65)
- ▶ Suitable for installation in bathrooms
- ▶ Protección contra chorros de agua y agua proyectada (IP65)
- ▶ Adecuado para en el baño
- ▶ Protezione da spruzzi e getti d'acqua (IP65)
- ▶ Per l'installazione in bagno

**Matt white/Chrome Blanco mate/Cromo Bianco opaco/Cromo**



incl. 1x6 W | 470 lm | GU10 | 2.700 K |  $\sphericalangle$ 36° | EAN 4000870 929032 | **929.03**

incl. 1x6 W | 470 lm | GU10 | 2.700 K |  $\sphericalangle$ 36° | EAN 4000870 929049 | **929.04**

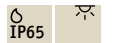
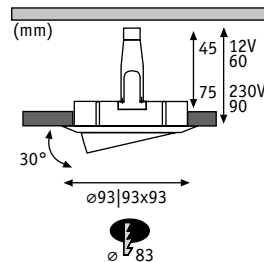

**Nova IP65 adjustable GU10/GU5,3**

Aluminium zinc / Aluminio cinc / Alluminio zincato

- ▶ Protected from spray water and water jets (IP65)
- ▶ Suitable for installation in bathrooms
- ▶ Protección contra chorros de agua y agua proyectada (IP65)
- ▶ Adecuado para en el baño
- ▶ Protezione da spruzzi e getti d'acqua (IP65)
- ▶ Per l'installazione in bagno

**Matt white/Chrome Blanco mate/Cromo Bianco opaco/Cromo**



max. 35 W | GU5,3 / GU10 | EAN 4000870 936634 | **936.63**

max. 35 W | GU5,3 / GU10 | EAN 4000870 936641 | **936.64**



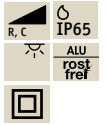
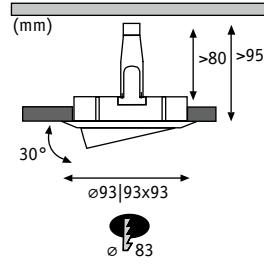

GU10 | dimmable | IP65

**Nova Plus IP65**

Aluminium zinc | Aluminio cinc | Alluminio zincato

**Matt white Blanco mate Bianco opaco**



incl. 1x6W | 470lm | GU10 | 4.000K |  $\sphericalangle$ 36° | EAN 4000870 936726 | **936.72**

**Brushed iron Hierro mateado Ferro spazzolato**



incl. 1x6W | 470lm | GU10 | 4.000K |  $\sphericalangle$ 36° | EAN 4000870 936719 | **936.71**

**Matt white/Chrome Blanco mate/Cromo Bianco opaco/Cromo**



incl. 1x6W | 470lm | GU10 | 4.000K |  $\sphericalangle$ 36° | EAN 4000870 936733 | **936.73**



incl. 1x6W | 470lm | GU10 | 4.000K |  $\sphericalangle$ 36° | EAN 4000870 936740 | **936.74**

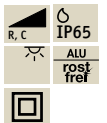
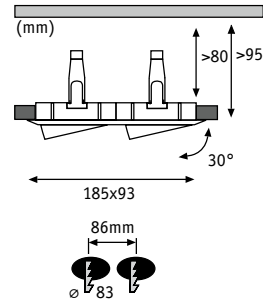

GU10 | dimmable | IP65

**Nova Plus IP65**

Aluminium zinc | Aluminio cinc | Alluminio zincato

**Matt white/Chrome Blanco mate/Cromo Bianco opaco/Cromo**



incl. 1x 2x6W | 1x | 2x470lm | GU10 | 4.000K |  $\sphericalangle$ 36° | EAN 4000870 936757 | **936.75**



incl. 1x 2x6W | 1x | 2x470lm | GU10 | 4.000K |  $\sphericalangle$ 36° | EAN 4000870 936764 | **936.76**



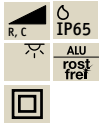
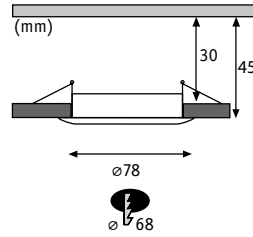

**LED IP65 230V Slim Coin Satin 51mm dimmable**

Aluminium zinc / Aluminio cinc / Alluminio zincato

- ▶ Shallow installation depth
- ▶ With safety glass
- ▶ Incl. junction box with double quick clamp for feeding through wires
- ▶ Mínima profundidad de empotre
- ▶ Con vidrio protector
- ▶ Incluye caja de conexión con conector rápido doble para paso de cable
- ▶ Profondità minima di incasso ridotta
- ▶ Con vetro di protezione
- ▶ Scatola di connessione con clip rapida doppia per il passaggio dei cavi

**Matt white Blanco mate Bianco opaco**



incl. 1x6W | 470 lm | Coin | 2.700K EAN 4000870 938812 **938.81**

**Brushed iron Hierro mateado Ferro spazzolato**



incl. 1x6W | 470 lm | Coin | 2.700K EAN 4000870 938829 **938.82**

**Chrome Cromo Cromo**



incl. 1x6W | 470 lm | Coin | 2.700K EAN 4000870 938836 **938.83**



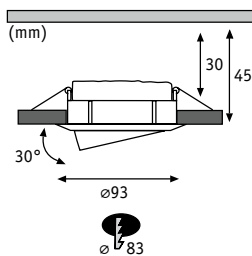

**Nova Plus Coin IP65 adjustable dimmable** Aluminium Aluminio Alluminio

**Matt white Blanco mate Bianco opaco**



	incl. 1x6 W		470 lm		Coin		2.700 K	EAN 4000870 936818		<b>936.81</b>
	incl. 3x6 W		3x470 lm		Coin		2.700 K	EAN 4000870 936825		<b>936.82</b>

**Chrome Cromo Cromo**



	incl. 1x6 W		470 lm		Coin		2.700 K	EAN 4000870 936832		<b>936.83</b>
	incl. 3x6 W		3x470 lm		Coin		2.700 K	EAN 4000870 936849		<b>936.84</b>

**Matt white/Chrome Blanco mate/Cromo Bianco opaco/Cromo**



	incl. 1x6 W		470 lm		Coin		2.700 K	EAN 4000870 936856		<b>936.85</b>
	incl. 3x6 W		3x470 lm		Coin		2.700 K	EAN 4000870 936863		<b>936.86</b>

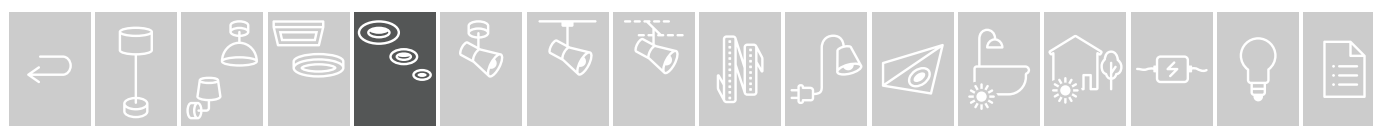



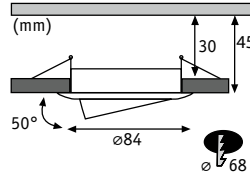

dimmable  
 smart controllable  
 zigbee



**Nova Plus Zigbee Coin dim**

Aluminium zinc Aluminio cinc Alluminio zincato

Brushed iron Hierro mateado Ferro spazzolato



	incl. 1x6 W		470 lm		Coin		2.700 K		∠100°	EAN 4000870 929582	<b>929.58</b>
	incl. 3x6 W		3x470 lm		Coin		2.700 K		∠100°	EAN 4000870 929599	<b>929.59</b>

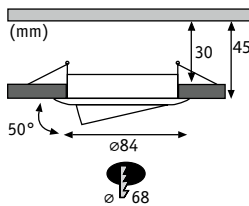

tunable white  
 smart controllable  
 zigbee



**Nova Plus Zigbee Coin tunable white**

Aluminium zinc Aluminio cinc Alluminio zincato

Brushed iron Hierro mateado Ferro spazzolato



	incl. 1x6 W		470 lm		Coin		2.700 - 6.500 K		∠100°	EAN 4000870 929612	<b>929.61</b>
	incl. 3x6 W		3x470 lm		Coin		2.700 - 6.500 K		∠100°	EAN 4000870 929629	<b>929.62</b>

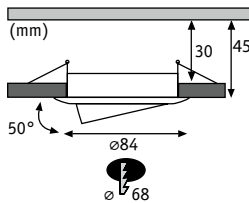

RGBW  
 smart controllable  
 zigbee



**Nova Plus Zigbee Coin RGBW**

Aluminium zinc Aluminio cinc Alluminio zincato

Brushed iron Hierro mateado Ferro spazzolato



	incl. 1x5,2 W		400 lm		Coin		2.700 K		∠100°	EAN 4000870 929643	<b>929.64</b>
	incl. 3x5,2 W		3x400 lm		Coin		2.700 K		∠100°	EAN 4000870 929650	<b>929.65</b>



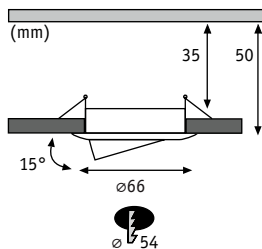

**Nova mini Coin**

Aluminium Aluminium Alluminio

**Matt white Blanco mate Bianco opaco**



incl. 1x4 W		310 lm		Coin		2.700 K		38°	EAN 4000870 942925	📦	<b>942.92</b>
incl. 3x4 W		3x310 lm		Coin		2.700 K		38°	EAN 4000870 942932		<b>942.93</b>

**Brushed iron Hierro mateado Ferro spazzolato**



incl. 1x4 W		310 lm		Coin		2.700 K		38°	EAN 4000870 942949	📦	<b>942.94</b>
incl. 3x4 W		3x310 lm		Coin		2.700 K		38°	EAN 4000870 942956		<b>942.95</b>

**Turned aluminium Aluminio torneado Alluminio tornito**



incl. 1x4 W		310 lm		Coin		2.700 K		38°	EAN 4000870 942963	📦	<b>942.96</b>
incl. 3x4 W		3x310 lm		Coin		2.700 K		38°	EAN 4000870 942970		<b>942.97</b>

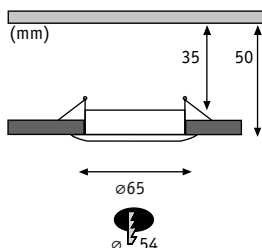

**Nova mini Coin IP44**

Aluminium Aluminium Alluminio

**Matt white Blanco mate Bianco opaco**



incl. 1x4 W		310 lm		Coin		2.700 K		38°	EAN 4000870 942987	📦	<b>942.98</b>
incl. 3x4 W		3x310 lm		Coin		2.700 K		38°	EAN 4000870 942994		<b>942.99</b>

**Brushed iron Hierro mateado Ferro spazzolato**



incl. 1x4 W		310 lm		Coin		2.700 K		38°	EAN 4000870 943007	📦	<b>943.00</b>
incl. 3x4 W		3x310 lm		Coin		2.700 K		38°	EAN 4000870 943014		<b>943.01</b>

**Chrome Cromo Cromo**



incl. 1x4 W		310 lm		Coin		2.700 K		38°	EAN 4000870 943021	📦	<b>943.02</b>
incl. 3x4 W		3x310 lm		Coin		2.700 K		38°	EAN 4000870 943038		<b>943.03</b>

**Turned aluminium Aluminio torneado Alluminio tornito**



incl. 1x4 W		310 lm		Coin		2.700 K		38°	EAN 4000870 943045	📦	<b>943.04</b>
incl. 3x4 W		3x310 lm		Coin		2.700 K		38°	EAN 4000870 943052		<b>943.05</b>

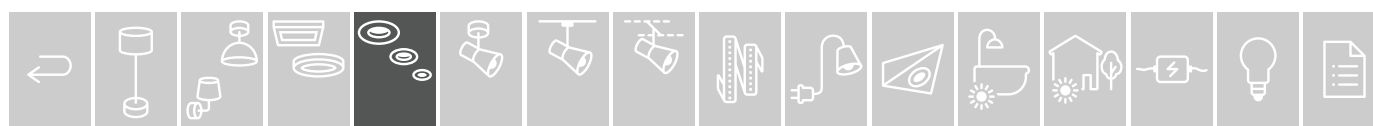

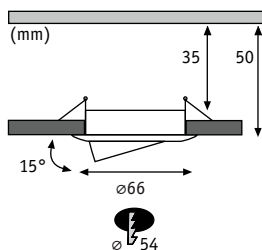

IP23  
ALU  
rost  
fref



**Nova mini Coin**

Aluminium Aluminium Alluminio

**Matt white Blanco mate Bianco opaco**



	incl. 1x4,2W		300lm		Coin		2.700K		38°	EAN 4000870 929704		<b>929.70</b>
	incl. 3x4,2W		3x300lm		Coin		2.700K		38°	EAN 4000870 929711		<b>929.71</b>

**Brushed iron Hierro mateado Ferro spazzolato**



	incl. 1x4,2W		300lm		Coin		2.700K		38°	EAN 4000870 929728		<b>929.72</b>
	incl. 3x4,2W		3x300lm		Coin		2.700K		38°	EAN 4000870 929735		<b>929.73</b>

**Turned aluminium Aluminium torneado Alluminio tornito**



	incl. 1x4,2W		300lm		Coin		2.700K		38°	EAN 4000870 929742		<b>929.74</b>
	incl. 3x4,2W		3x300lm		Coin		2.700K		38°	EAN 4000870 929759		<b>929.75</b>

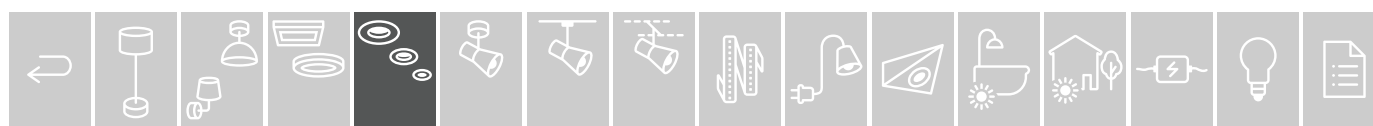

# CHOOSE!



EN Custom combinations of recessed luminaires!  
 ES ¡Combine la luminaria empotrable que desee!  
 IT Faretto da incasso da abbinare a piacimento.

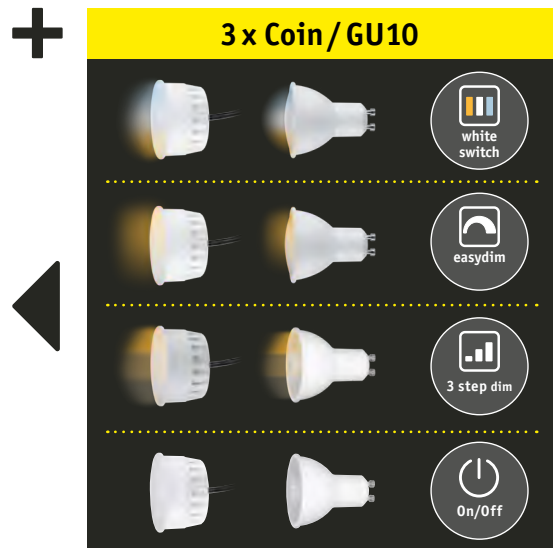

Safe connection, without transformer  
 Conexión segura, sin transformador  
 Collegamento sicuro senza trasformatore



Link up any number of luminaires via the connection box supplied  
 Concatenable sin limitaciones con caja de conexión incluida  
 Applicazione illimitata con scatola di collegamento compresa



Standard 68 mm bore diameter  
 Diámetro de taladro estándar 68 mm  
 Diametro foro standard 68 mm



Retaining springs for easy installation and removal  
 Resortes de sujeción para facilitar el montaje y desmontaje  
 Molle per facilitare montaggio e smontaggio



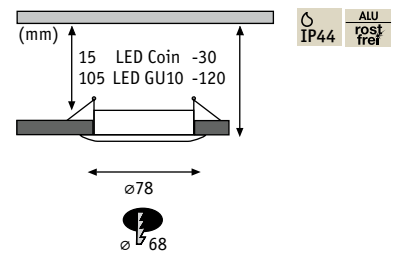
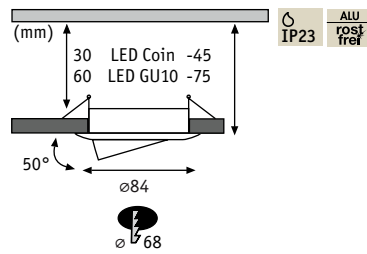

**Choose! Spot Set**

Aluminium Aluminium Alluminio

Matt white Blanco mate Bianco opaco

Brushed iron Hierro mateado  
Ferro spazzolato

Chrome Cromo Cromo



**max. 3×10W**  
EAN 4000870 924860  
**924.86**



**max. 3×10W**  
EAN 4000870 924853  
**924.85**



**max. 3×10W**  
EAN 4000870 924884  
**924.88**



**max. 3×10W**  
EAN 4000870 924808  
**924.80**



**max. 3×10W**  
EAN 4000870 924792  
**924.79**



**max. 3×10W**  
EAN 4000870 924822  
**924.82**

Turned aluminium Aluminium torneado  
Alluminio tornito

Black matt Negro mate Nero opaco

Brushed brass Latón mateado  
Ottone spazzolato



**max. 3×10W**  
EAN 4000870 924907  
**924.90**



**max. 3×10W**  
EAN 4000870 924877  
**924.87**



**max. 3×10W**  
EAN 4000870 924891  
**924.89**



**max. 3×10W**  
EAN 4000870 924846  
**924.84**



**max. 3×10W**  
EAN 4000870 924815  
**924.81**



**max. 3×10W**  
EAN 4000870 924839  
**924.83**

**Choose! GU10 Set**

White Blanco Bianco



On/Off

**3×6,5W**  
3×460 lm, 2.700 K  
∠ 38°, 700 cd  
230V  
EAN 4000870 287842  
**287.84**



3 step dim

**3×6,5W**  
3×460 lm, 2.700 K  
∠ 38°, 780 cd  
230V  
EAN 4000870 287859  
**287.85**



easy dim

**3×5,5W**  
3×460 lm, 2.700 K  
∠ 110°  
230V  
EAN 4000870 287866  
**287.86**



white switch

**3×5,9W**  
3×470 lm, 2.700 - 6.500 K  
∠ 110°  
230V  
EAN 4000870 287873  
**287.87**

**Choose! Coin Set**

Satin Satinado Satinato



**incl. 3×6W**  
3×470 lm, 2.700 K, ∠ 100°  
230V  
EAN 4000870 924723  
**924.72 new**



3 step dim

**incl. 3×6W**  
3×470 lm, 2.700 K, ∠ 100°  
230V  
EAN 4000870 924730  
**924.73 new**



easy dim

**3×6,5W**  
3×630 lm, 2.700 K  
230V  
EAN 4000870 924778  
**924.77**



white switch

**3×6,5W**  
3×580-620 lm  
2.700 - 6.500 K, 230V  
EAN 4000870 924785  
**924.78**



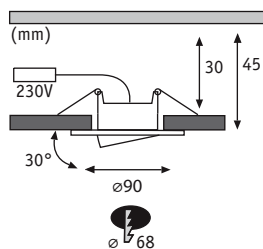

**Calla IP65**

Plastic Plástico Plastica

**Matt white Blanco mate Bianco opaco**



	incl. 1x6 W		680 lm		4.000 K		◊100°		EAN 4000870 999264		<b>999.26</b>
	incl. 1x5,2 W		560 lm		4.000 K		◊100°		EAN 4000870 999301		<b>999.30</b>
	incl. 3x5,5 W		3x680 lm		4.000 K		◊100°		EAN 4000870 999271		<b>999.27</b>
	incl. 3x5,2 W		3x560 lm		4.000 K		◊100°		EAN 4000870 999318		<b>999.31</b>
	incl. 10x6 W		10x680 lm		4.000 K		◊100°		EAN 4000870 999226		<b>999.22</b>
	incl. 10x5,2 W		10x560 lm		4.000 K		◊100°		EAN 4000870 999240		<b>999.24</b>

**Chrome matt Cromo mate Cromo opaco**



	incl. 1x6 W		680 lm		4.000 K		◊100°		EAN 4000870 999288		<b>999.28</b>
	incl. 1x5,2 W		560 lm		4.000 K		◊100°		EAN 4000870 999325		<b>999.32</b>
	incl. 3x5,5 W		3x680 lm		4.000 K		◊100°		EAN 4000870 999295		<b>999.29</b>
	incl. 3x5,2 W		3x560 lm		4.000 K		◊100°		EAN 4000870 999332		<b>999.33</b>
	incl. 10x6 W		10x680 lm		4.000 K		◊100°		EAN 4000870 999233		<b>999.23</b>
	incl. 10x5,2 W		10x560 lm		4.000 K		◊100°		EAN 4000870 999257		<b>999.25</b>

**Black matt Negro mate Nero opaco**



	incl. 3x6,5 W		3x680 lm		4.000 K		◊100°		EAN 4000870 999912	<b>new</b>	<b>999.91</b>
--	---------------	--	----------	--	---------	--	-------	--	--------------------	------------	---------------

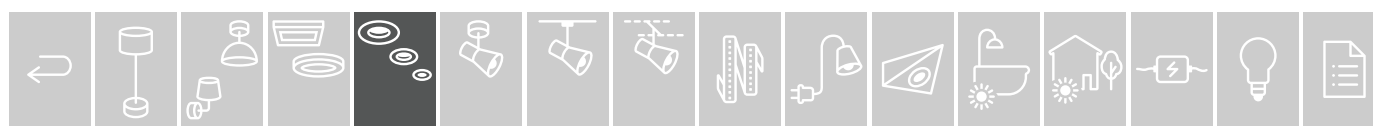

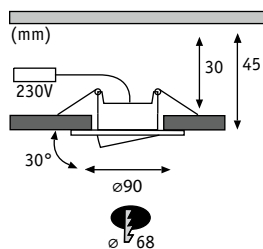

**Calla IP65** Plastic Plástico Plastica

**Matt white Blanco mate Bianco opaco**



	incl. 1x5,5W		550lm		3.000 - 6.500 K		∠100°	EAN 4000870 999349		<b>999.34</b>
	incl. 3x5,5W		3x550lm		3.000 - 6.500 K		∠100°	EAN 4000870 999356		<b>999.35</b>

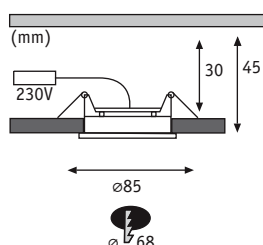

**Calla IP65** Plastic/Aluminium Plástico/Aluminio Plastica/Alluminio

**Matt white Blanco mate Bianco opaco**



	incl. 1x5W		500lm		4.000 K		∠100°	EAN 4000870 999363		<b>999.36</b>
--	------------	--	-------	--	---------	--	-------	--------------------	--	---------------

**Chrome matt Cromo mate Cromo opaco**



	incl. 1x5W		500lm		4.000 K		∠100°	EAN 4000870 999370		<b>999.37</b>
--	------------	--	-------	--	---------	--	-------	--------------------	--	---------------

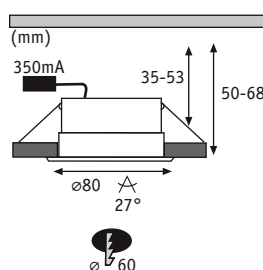

**Calla IP65** Plastic/Aluminium Plástico/Aluminio Plastica/Alluminio

**Matt white Blanco mate Bianco opaco**



	incl. 1x6,7W		770lm		4.000 K		∠27°		incl.	EAN 4000870 936702	<b>936.70</b>
--	--------------	--	-------	--	---------	--	------	--	-------	--------------------	---------------

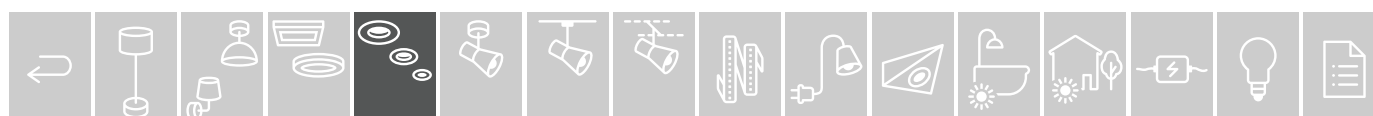

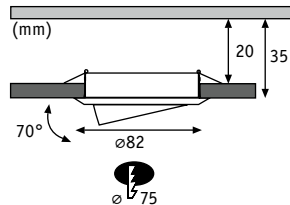

**Fixed LED Set new**

Plastic Plástico Plastica

**Matt white Blanco mate Bianco opaco**



incl. 3x6W | 3x580lm | 3.000K

EAN 4000870 933886

**933.88**

**Chrome matt Cromo mate Cromo opaco**



incl. 3x6W | 3x580lm | 3.000K

EAN 4000870 933893

**933.89**

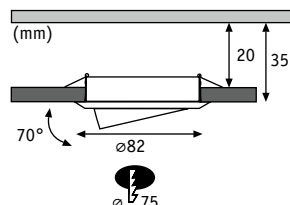

**3 step dim**

**Fixed LED Set**

Plastic Plástico Plastica

**Matt white Blanco mate Bianco opaco**



**3 step dim** incl. 3x6W | 3x550lm | 3.000K |  $\sphericalangle$ 40°

EAN 4000870 929858

**929.85**

**Chrome matt Cromo mate Cromo opaco**



**3 step dim** incl. 3x6W | 3x550lm | 3.000K |  $\sphericalangle$ 40°

EAN 4000870 929865

**929.86**

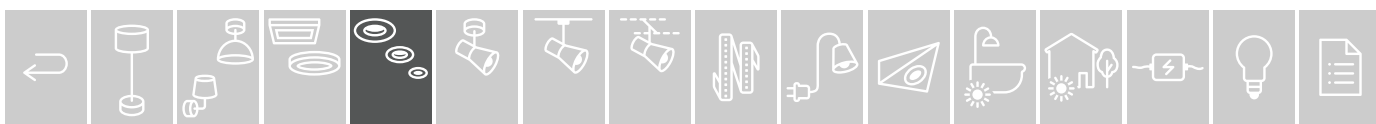



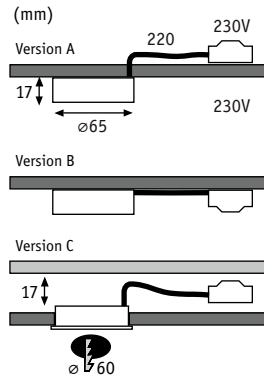

**Pukk LED Set**

Plastic Plástico Plastica

**White Blanco Bianco**



incl. 3x3,5 W | 3x300 lm | 2.700 K

EAN 4000870 999899

**999.89**

**Black Negro Nero**



incl. 3x3,5 W | 3x300 lm | 2.700 K

EAN 4000870 999905

**999.90**



GU10

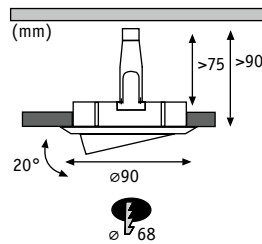

**230V GU10 51mm**

Metal Metal Metallo

**White Blanco Bianco**



max. 3x10 W | GU10

EAN 4000870 933909

**933.90**

max. 10x10 W | GU10

EAN 4000870 934005

**934.00**

**Brushed iron Hierro mateado Ferro spazzolato**



max. 3x10 W | GU10

EAN 4000870 933916

**933.91**

max. 10x10 W | GU10

EAN 4000870 933992

**933.99**



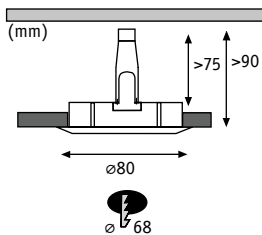

230V GU10 51mm

Metal Metal Metallo

**White Blanco Bianco**



max. 3x10W

| GU10

EAN 4000870 933923

**933.92**

**Brushed iron Hierro mateado Ferro spazzolato**



max. 3x10W

| GU10

EAN 4000870 933930

**933.93**

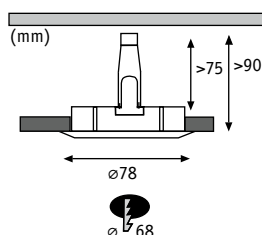

Nova 230V GU10 51mm

Aluminium zinc Aluminio cinc Alluminio zincato

**Matt white Blanco mate Bianco opaco**



max. 35W

| GU10

EAN 4000870 936313

**936.31**

**Brushed iron Hierro mateado Ferro spazzolato**



max. 35W

| GU10

EAN 4000870 936337

**936.33**

**Turned aluminium Aluminio torneado Alluminio tornito**



max. 35W

| GU10

EAN 4000870 936320

**936.32**

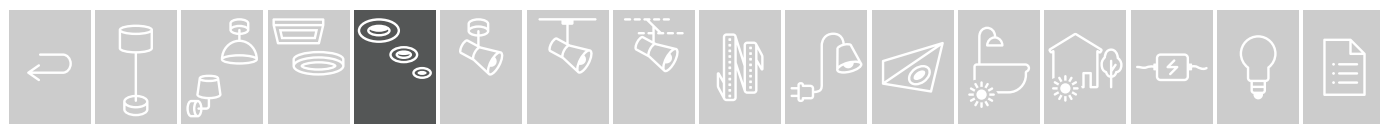

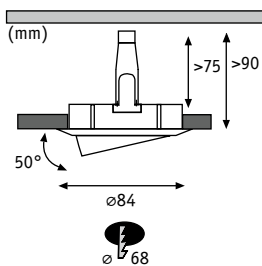

**Nova 230V GU10 51mm**

Aluminium zinc Aluminium cinc Alluminio zincato

**Matt white Blanco mate Bianco opaco**



max. 35 W

| GU10

EAN 4000870 936399 **936.39**

**Brushed iron Hierro mateado Ferro spazzolato**



max. 35 W

| GU10

EAN 4000870 936412 **936.41**

**Turned aluminium Aluminio torneado Alluminio tornito**



max. 35 W

| GU10

EAN 4000870 936405 **936.40**

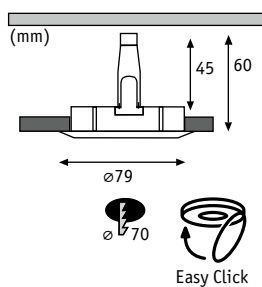

**IP44 12V GU5,3 51mm**

Aluminium zinc Aluminium cinc Alluminio zincato

**White Blanco Bianco**



max. 50 W

| GU5,3

EAN 4000870 179437 **179.43**

**Brushed iron Hierro mateado Ferro spazzolato**



max. 50 W

| GX5,3

EAN 4000870 179451 **179.45**

**Chrome Cromo Cromo**



max. 50 W

| GU5,3

EAN 4000870 179468 **179.46**

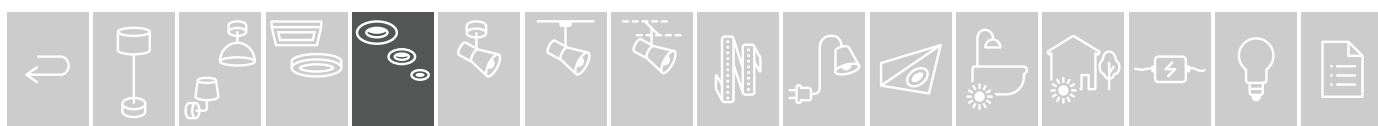

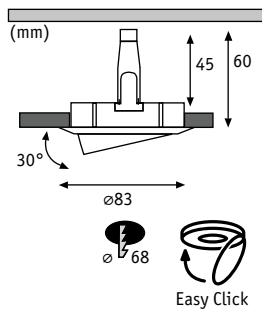

12V GU5,3 51mm

Aluminium zinc Aluminium zinc Alluminio zincato



**White Blanco Bianco**

max. 50 W

| GU5,3

EAN 4000870 179536 179.53



**Chrome matt Cromo mate Cromo opaco**

max. 50 W

| GU5,3

EAN 4000870 179543 179.54



**Brushed iron Hierro mateado Ferro spazzolato**

max. 50 W

| GX5,3

EAN 4000870 179550 179.55



**Black Negro Nero**

max. 50 W

| GU5,3

EAN 4000870 179512 179.51

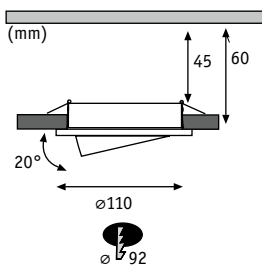

12V GU5,3 51mm

Metal Metal Metallo



**White Blanco Bianco**

max. 50 W

| GU5,3

EAN 4000870 989715 989.71



**Brushed iron Hierro mateado Ferro spazzolato**

max. 50 W

| GU5,3

EAN 4000870 989685 989.68

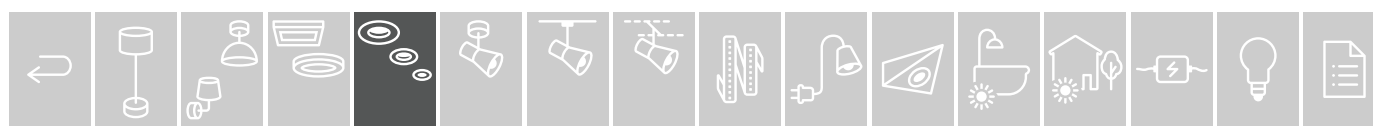

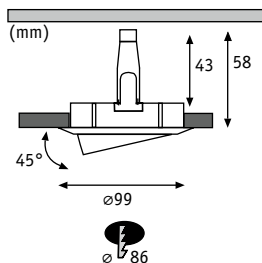

12V GU5,3 51mm

Aluminium Aluminio Alluminio

**White Blanco Bianco**



max. 50 W

| GU5,3

EAN 4000870 987735 **987.73**

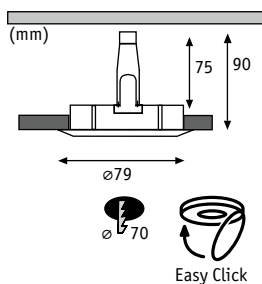

IP44 230V GU10 51mm

Aluminium zinc Aluminio cinc Alluminio zincato

**White Blanco Bianco**



max. 50 W

| GU10

EAN 4000870 057926 **5792**

**Brushed iron Hierro mateado Ferro spazzolato**



max. 50 W

| GU10

EAN 4000870 057964 **5796**

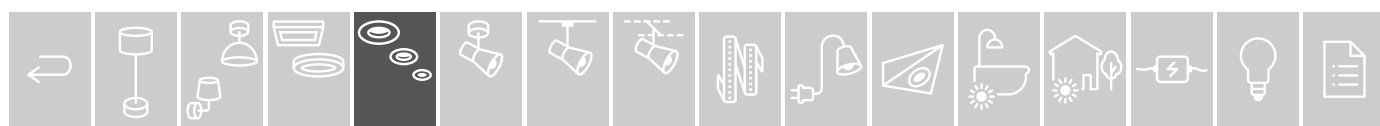

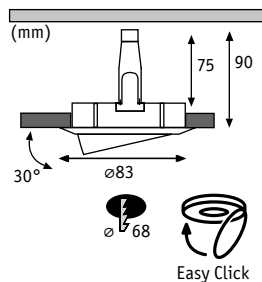

230V GU10 51mm

Aluminium zinc / Aluminio cinc / Alluminio zincato

**White Blanco Bianco**



max. 50 W

| GU10

EAN 4000870 989401

989.40

**Brushed iron Hierro mateado Ferro spazzolato**



max. 50 W

| GU10

EAN 4000870 988787

988.78

**Chrome Cromo Cromo**



max. 50 W

| GU10

EAN 4000870 989432

989.43

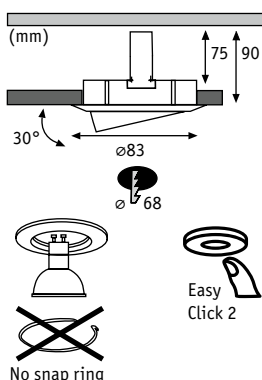

**EasyClick2**

Aluminium zinc / Aluminio cinc / Alluminio zincato

- ▶ No snap ring necessary
- ▶ Sin necesidad de circlip
- ▶ Anello di arresto non necessario
- ▶ Bulb exchange simply by pressing on the bulb
- ▶ Luminaria fácil de cambiar presionando sencillamente sobre ella
- ▶ Sostituzione semplice della lampadina premendo su di essa

**White Blanco Bianco**



max. 50 W

| GU10

EAN 4000870 937310

937.31

**Brushed iron Hierro mateado Ferro spazzolato**



max. 50 W

| GU10

EAN 4000870 937303

937.30





LED Coin Base

Opal Opal Opale



A	G	W	⊖	∅ mm	⇅ mm	lm	↘	K	⌚	📦	EAN	🏷️
		<b>incl. 5</b>	Coin	51	40	370	100	3.000	15.000	1	4000870 930762	<b>new 930.76</b>
8,3 VA												



LED Coin Base 3-Step-Dim

Opal Opal Opale

A	G	W	⊖	∅ mm	⇅ mm	lm	↘	K	⌚	📦	EAN	🏷️
		<b>incl. 5</b>	Coin	51	40	370	100	3.000	15.000	1	4000870 930779	<b>new 930.77</b>
10,5 VA												



LED Coin Nova

Satin Satinado Satinato



A	G	W	⊖	∅ mm	⇅ mm	lm	↘	K	⌚	📦	EAN	🏷️
		<b>incl. 6</b>	Coin	50	30	470	100	2.700	30.000	1	4000870 930694	<b>new 930.69</b>



LED Coin Nova

Satin Satinado Satinato

A	G	W	⊖	∅ mm	⇅ mm	lm	↘	K	⌚	📦	EAN	🏷️
		<b>incl. 6</b>	Coin	50	30	530	100	4.000	30.000	1	4000870 930717	<b>new 930.71</b>
12 VA												



LED Coin Nova 3-Step-Dim

Satin Satinado Satinato

A	G	W	⊖	∅ mm	⇅ mm	lm	↘	K	⌚	📦	EAN	🏷️
		<b>incl. 6</b>	Coin	50	30	470	100	2.700	30.000	1	4000870 930700	<b>new 930.70</b>



LED Coin Nova 3-Step-Dim

Satin Satinado Satinato

A	G	W	⊖	∅ mm	⇅ mm	lm	↘	K	⌚	📦	EAN	🏷️
		<b>incl. 6</b>	Coin	50	30	530	100	4.000	30.000	1	4000870 930724	<b>new 930.72</b>
11 VA												



LED Coin Nova Plus Dim

Satin Satinado Satinato

A	G	W	⊖	∅ mm	⇅ mm	lm	↘	K	⌚	📦	EAN	🏷️
		<b>incl. 6</b>	Coin	50	30	470	120	2.700	30.000	1	4000870 930786	<b>new 930.78</b>



LED Coin Nova Plus Dim

Satin Satinado Satinato

A	G	W	⊖	∅ mm	⇅ mm	lm	↘	K	⌚	📦	EAN	🏷️
		<b>incl. 6</b>	Coin	50	35	520	120	4.000	30.000	1	4000870 930793	<b>new 930.79</b>

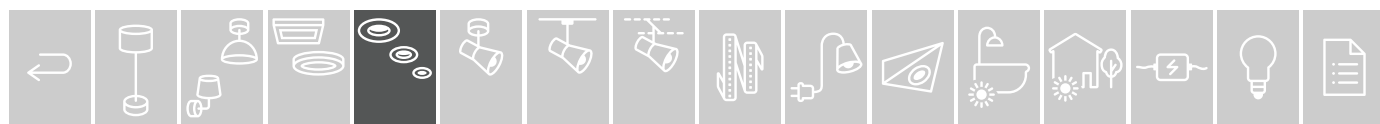



Satin Satinado Satinato

W	⊖	∅ mm	↑ mm	Lm	↘	K	⌚	📦	EAN	📱
<b>incl. 6,3</b>	Coin	50	30	430	38	2.700	30.000	1	4000870 924716	<b>new 92471</b>

LED Coin Nova Plus Reflector



Satin Satinado Satinato

W	⊖	∅ mm	↑ mm	Lm	↘	K	⌚	📦	EAN	📱
<b>incl. 6</b>	Coin	50	35	470	100	2.700	30.000	1	4000870 930731	<b>new 930.73</b>

LED Coin Nova Plus ZigBee Dim



Satin Satinado Satinato

W	⊖	∅ mm	↑ mm	Lm	↘	K	⌚	📦	EAN	📱
<b>incl. 6</b>	Coin	50	35	470	100	2.200 - 6.500	30.000	1	4000870 930748	<b>new 930.74</b>

LED Coin Nova Plus ZigBee Tunable White



Satin Satinado Satinato

W	⊖	∅ mm	↑ mm	Lm	↘	K	⌚	📦	EAN	📱
<b>incl. 5,2</b>	Coin	50	35	400	100	2.700 - 6.500	30.000	1	4000870 930755	<b>new 930.75</b>

LED Coin Nova Plus ZigBee RGBW



Clear Transparente Trasparente

W	⊖	∅ mm	↑ mm	Lm	↘	K	⌚	📦	EAN	📱
<b>incl. 4</b>	Coin	35	27	310	38	2.700	30.000	1	4000870 943069	<b>943.06</b>

LED Coin Nova mini



Clear Transparente Trasparente

W	⊖	∅ mm	↑ mm	Lm	↘	K	⌚	📦	EAN	📱
<b>incl. 4,2</b>	Coin	35	30	300	38	2.700	30.000	1	4000870 929766	<b>929.76</b>

LED Coin Nova mini Plus EasyDim

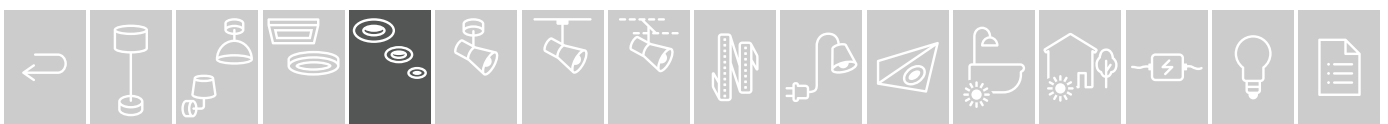

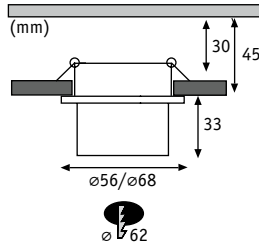

**GIL**GLARE FREE DESIGNER  
RECESSED LUMINAIRES

Gil new

Aluminium Aluminio Alluminio



**Matt white/Black matt Blanco mate/Negro mate Bianco opaco/Nero opaco**

incl. 1x6 W		470 lm		Coin		2.700 K		EAN 4000870 933763	<b>933.76</b>
incl. 3x6 W		3x470 lm		Coin		2.700 K		EAN 4000870 933770	<b>933.77</b>



**Black matt/Gold Negro mate/Oro Nero opaco/Oro**

incl. 1x6 W		470 lm		Coin		2.700 K		EAN 4000870 933787	<b>933.78</b>
incl. 3x6 W		3x470 lm		Coin		2.700 K		EAN 4000870 933794	<b>933.79</b>



**Matt white/Gold Blanco mate/Oro Bianco opaco/Oro**

incl. 1x6 W		470 lm		Coin		2.700 K		EAN 4000870 933800	<b>933.80</b>
incl. 3x6 W		3x470 lm		Coin		2.700 K		EAN 4000870 933817	<b>933.81</b>



**Black matt/Brushed iron Negro mate/Hierro mateado Nero opaco/Ferro spazzolato**

incl. 1x6 W		470 lm		Coin		2.700 K		EAN 4000870 933824	<b>933.82</b>
incl. 3x6 W		3x470 lm		Coin		2.700 K		EAN 4000870 933831	<b>933.83</b>



**Matt white/Brushed iron Blanco mate/Hierro mateado Bianco opaco/Ferro spazzolato**

incl. 1x6 W		470 lm		Coin		2.700 K		EAN 4000870 933848	<b>933.84</b>
incl. 3x6 W		3x470 lm		Coin		2.700 K		EAN 4000870 933855	<b>933.85</b>



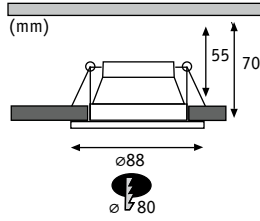

**Cole** Plastic/Aluminium zinc Plástico/Aluminio cinc Plastica/Alluminio zincato

- Decorative glare-free recessed luminaires with 3-step dimming
- Decorativas luminarias empotrables sin deslumbramiento con regulación 3Step
- Lampade da incasso non abbaglianti e decorative, con variazione dell'intensità 3Step

**White/Black matt Blanco/Negro mate Bianco/Nero opaco**



	incl. 1x6 W		470 lm		Coin		2.700 K		◊100°	EAN 4000870 934012		<b>934.01</b>
	incl. 3x6 W		3x470 lm		Coin		2.700 K		◊100°	EAN 4000870 934029		<b>934.02</b>

**Black/Gold matt Negro/Oro mate Nero/Oro opaco**



	incl. 1x6 W		470 lm		Coin		2.700 K		◊100°	EAN 4000870 934036		<b>934.03</b>
	incl. 3x6 W		3x470 lm		Coin		2.700 K		◊100°	EAN 4000870 934043		<b>934.04</b>

**White/Gold matt Blanco/Oro mate Bianco/Oro opaco**



	incl. 1x6 W		470 lm		Coin		2.700 K		◊100°	EAN 4000870 934050		<b>934.05</b>
	incl. 3x6 W		3x470 lm		Coin		2.700 K		◊100°	EAN 4000870 934067		<b>934.06</b>

**Black/Silver Negro/Plateado Nero/Argento**



	incl. 1x6 W		470 lm		Coin		2.700 K		◊100°	EAN 4000870 934074		<b>934.07</b>
	incl. 3x6 W		3x470 lm		Coin		2.700 K		◊100°	EAN 4000870 934081		<b>934.08</b>

**White/Silver Blanco/Plateado Bianco/Argento**



	incl. 1x6 W		470 lm		Coin		2.700 K		◊100°	EAN 4000870 934098		<b>934.09</b>
	incl. 3x6 W		3x470 lm		Coin		2.700 K		◊100°	EAN 4000870 934104		<b>934.10</b>

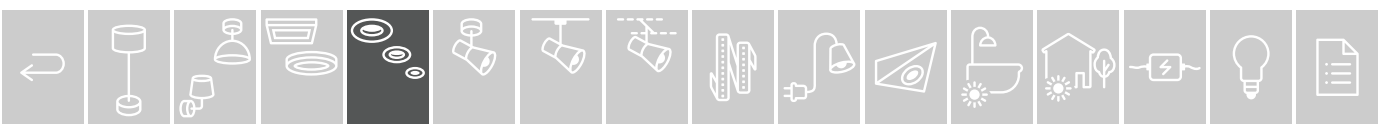

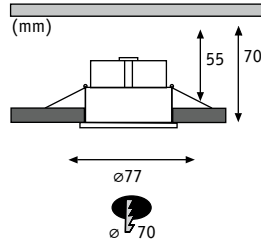

**Cymbal** Plastic Plástico Plastica

**Matt white Blanco mate Bianco opaco**



incl. 3x6,7W		3x440lm		Coin		2.700K		30°	EAN 4000870 934159	<b>934.15</b>
incl. 1x6,7W		440lm		Coin		2.700K		30°	EAN 4000870 934166	<b>934.16</b>

**Cymbal** Plastic Plástico Plastica

**Matt white Blanco mate Bianco opaco**



max. 10W		440lm		440lm
----------	--	-------	--	-------

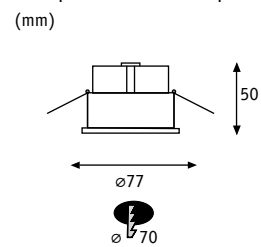

EAN 4000870 934173 **934.17**

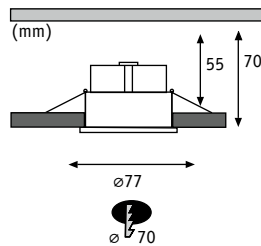
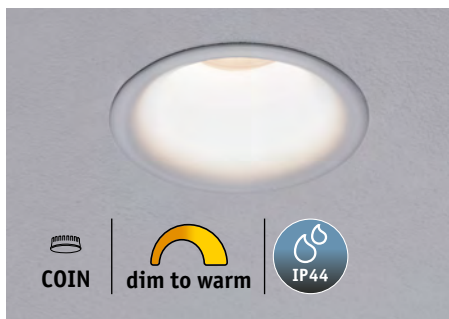

**Cymbal** Plastic Plástico Plastica

**Matt white Blanco mate Bianco opaco**



incl. 1x6W		430lm		Coin		2.000 - 2.700K		45°	EAN 4000870 934180	<b>934.18</b>
incl. 3x6W		3x430lm		Coin		2.000 - 2.700K		45°	EAN 4000870 934197	<b>934.19</b>



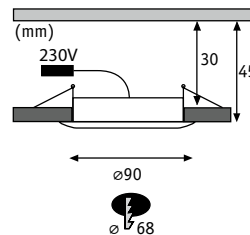
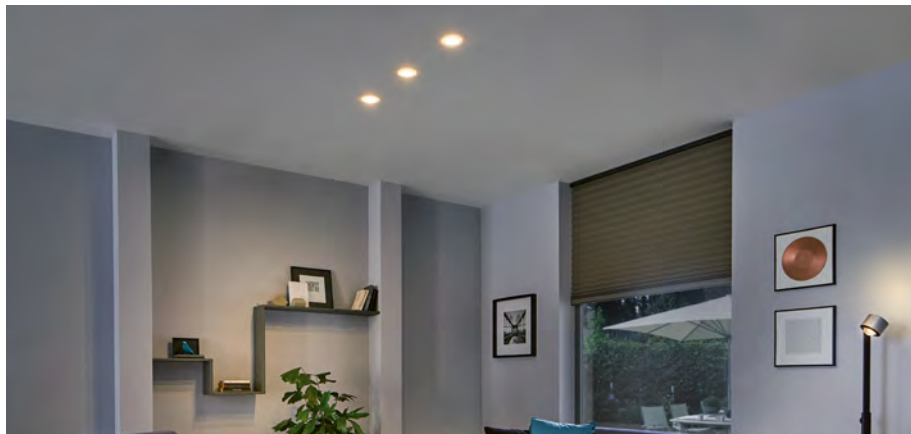

**Premium Suon 230V**

Plastic Plástico Plastica

- ▶ Without a frame, the luminaire appears to be invisible on the ceiling
- ▶ Sin marco, la lámpara parece invisible en el techo
- ▶ Senza cornice l'apparecchio a soffitto risulta invisibile

**Satin/White Satinado/Blanco Satinato/Bianco**



incl. 1x6,5W		650 lm		2.000 - 2.700 K	EAN 4000870 999431	<b>999.43</b>
incl. 3x6,5W		3x650 lm		2.000 - 2.700 K	EAN 4000870 999424	<b>999.42</b>



incl. 1x4,8W		650 lm		2.700 K	EAN 4000870 999417	<b>999.41</b>
incl. 3x4,8W		3x650 lm		2.700 K	EAN 4000870 999400	<b>999.40</b>

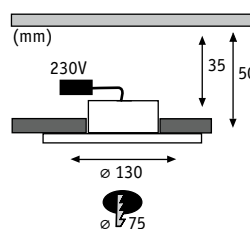

**Whirl LED new**

Plastic Plástico Plastica

**White/Clear Blanco/Transparente Bianco/Trasparente**



incl. 3x4,2W		3x480 lm		2.700 K	EAN 4000870 933862	<b>933.86</b>
--------------	--	----------	--	---------	--------------------	---------------



incl. 3x4,2W		3x520 lm		4.000 K	EAN 4000870 933879	<b>933.87</b>
--------------	--	----------	--	---------	--------------------	---------------

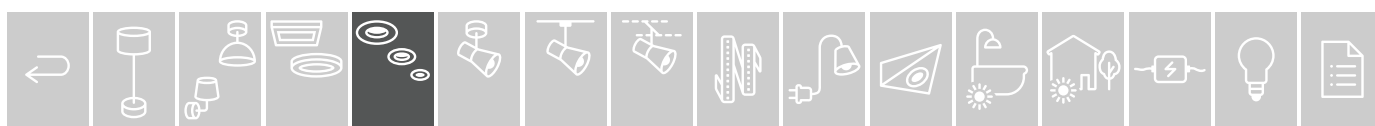

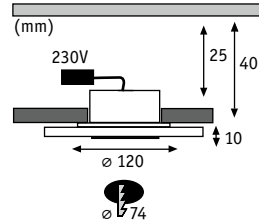

Premium Whirl 120mm dimmable

Aluminium/Acrylic Alumínio/Acrílico Alluminio/Acrílico

Turned aluminium/Satin Alumínio torneado/Satinado Alluminio tornito/Satinato



incl. 3x4,9W | 3x460 lm | 3.000 K |  $\leq 110^\circ$  EAN 4000870 929070 **929.07**

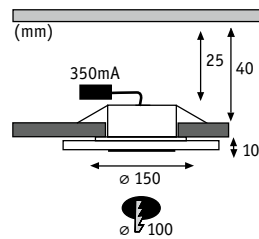

Premium Whirl LED

Aluminium/Acrylic Alumínio/Acrílico Alluminio/Acrílico

Turned aluminium/Satin Alumínio torneado/Satinado Alluminio tornito/Satinato



incl. 1x6,9W | 655 lm | 3.000 K | | incl.  $\square$  6 VA EAN 4000870 925355 **925.35**  
 incl. 3x6,9W | 3x655 lm | 3.000 K |  $\leq 113^\circ$  | incl.  $\square$  23 VA EAN 4000870 925430 **925.43**  
 incl. 3x6,9W | 3x655 lm | 3.000 K |  $\leq 110^\circ$  | incl.  $\square$  18 VA EAN 4000870 929179 **929.17**

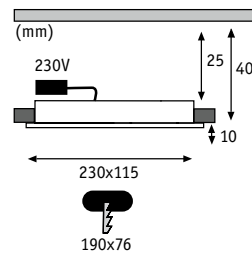

Premium Whirl oval dimmable

Aluminium/Acrylic Alumínio/Acrílico Alluminio/Acrílico

Turned aluminium/Satin Alumínio torneado/Satinado Alluminio tornito/Satinato

incl. 1x5,8W | 680 lm | 3.000 K |  $\leq 110^\circ$  EAN 4000870 929087 **929.08**



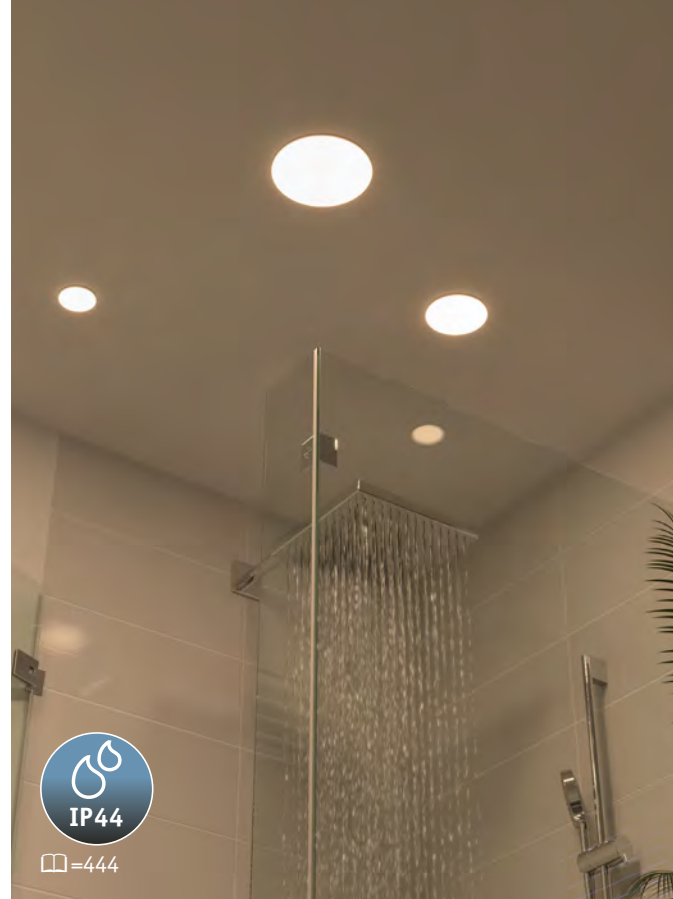

## LED recessed panels

Planar lighting for recessed installation

LED panels combine full coverage room light with the benefits of recessed luminaires. The attractive, frameless design blends easily with any interior style. Recessed panels with adjustable spring clamps are a perfect replacement for obsolete recessed luminaire systems. Our great range is rounded off with controllable and smart models.

## Paneles LED empotrables

Luz difusa para el montaje empotrado

Los paneles LED combinan una luz difusa con las ventajas de las luminarias empotrables. Las agradables variantes sin marco se integran discretamente en cualquier estancia. Una solución ideal para sustituir sistemas de luminarias empotrables anticuados son los paneles empotrables con muelles de sujeción regulables. Las variantes controlables e inteligentes completan de forma óptima el amplio surtido.

## Pannelli LED a incasso

Luce piatta da incasso:

i pannelli LED coniugano la luce d'ambiente piatta con i vantaggi dei faretti a incasso. Varianti senza cornice con una luce confortevole si integrano in ogni ambiente in modo discreto. I pannelli a incasso con molle di fissaggio regolabili sono ideali per sostituire sistemi di faretti a incasso obsoleti. Varianti comandabili e smart completano il vasto assortimento in modo ottimale.



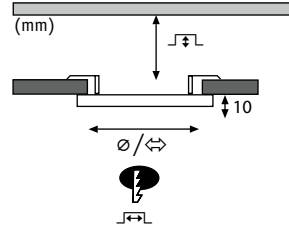
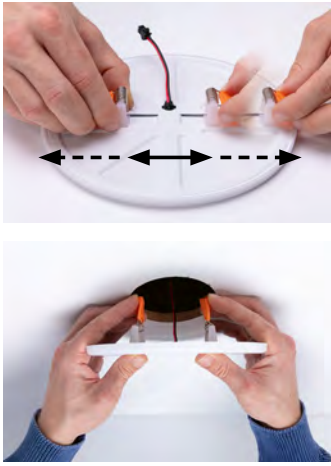













**Veluna VariFit**

Plastic Plástico Plástica

**warm white = 3.000 K**

	<b>ø75 mm</b>						
	500 lm		incl. 1×4,5 W	↕45-70 mm	↕45-55 mm	EAN 4000870 923870	<b>923.87</b>
	<b>↔75 ↔75 mm</b>						
	500 lm		incl. 1×4,5 W	↕45-70 mm	↕45-55 mm	EAN 4000870 923931	<b>923.93</b>
	<b>ø125 mm</b>						
	900 lm		incl. 1×8,5 W	↕45-70 mm	↕45-100 mm	EAN 4000870 923887	<b>923.88</b>
	<b>↔125 ↔125 mm</b>						
	900 lm		incl. 1×8,5 W	↕45-70 mm	↕45-100 mm	EAN 4000870 923948	<b>923.94</b>
	<b>ø185 mm</b>						
	1.850 lm		incl. 1×17 W	↕45-70 mm	↕45-160 mm	EAN 4000870 923894	<b>923.89</b>
	<b>↔185 ↔185 mm</b>						
	1.850 lm		incl. 1×17 W	↕45-70 mm	↕45-160 mm	EAN 4000870 923955	<b>923.95</b>

**neutral white = 4.000 K**

	<b>ø75 mm</b>						
	550 lm		incl. 1×4,5 W	↕45-70 mm	↕45-55 mm	EAN 4000870 923900	<b>923.90</b>
	<b>↔75 ↔75 mm</b>						
	550 lm		incl. 1×4,5 W	↕45-70 mm	↕45-55 mm	EAN 4000870 923962	<b>923.96</b>
	<b>ø125 mm</b>						
	1.000 lm		incl. 1×8,5 W	↕45-70 mm	↕45-100 mm	EAN 4000870 923917	<b>923.91</b>
	<b>↔125 ↔125 mm</b>						
	1.050 lm		incl. 1×8,5 W	↕45-70 mm	↕45-100 mm	EAN 4000870 923979	<b>923.97</b>
	<b>ø185 mm</b>						
	1.900 lm		incl. 1×17,5 W	↕45-70 mm	↕45-160 mm	EAN 4000870 923924	<b>923.92</b>
	<b>↔185 ↔185 mm</b>						
	1.900 lm		incl. 1×17,5 W	↕45-70 mm	↕45-160 mm	EAN 4000870 923986	<b>923.98</b>

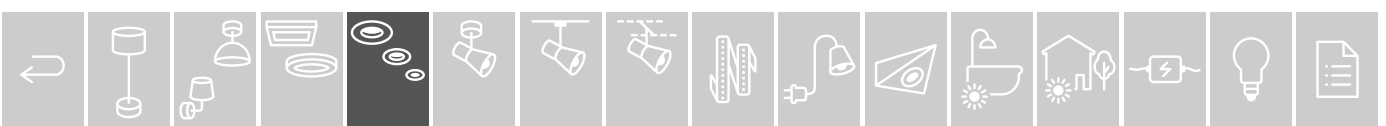

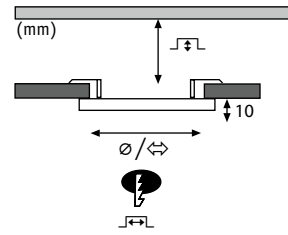
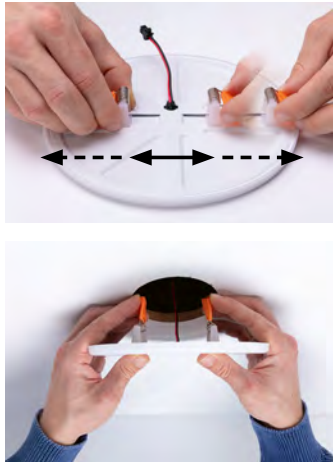

**Veluna VariFit**

Plastic Plástico Plástica

warm white = 3.000 K – 3 step dim

	<b>ø185 mm</b>	1.860 lm		incl. 1x17 W	└─┘45-70 mm	└─┘50-160 mm	EAN 4000870 930632	<b>930.63</b>
	<b>⇔185 ⇨185 mm</b>	1.900 lm		incl. 1x17 W	└─┘45-70 mm	└─┘50-160 mm	EAN 4000870 930618	<b>930.61</b>
	<b>ø215 mm</b>	2.350 lm		incl. 1x21 W	└─┘45-70 mm	└─┘50-190 mm	EAN 4000870 930649	<b>930.64</b>
	<b>⇔215 ⇨215 mm</b>	2.400 lm		incl. 1x21 W	└─┘45-70 mm	└─┘50-190 mm	EAN 4000870 930625	<b>930.62</b>

neutral white = 4.000 K – 3 step dim

	<b>ø185 mm</b>	1.900 lm		incl. 1x17,5 W	└─┘45-70 mm	└─┘50-160 mm	EAN 4000870 930670	<b>930.67</b>
	<b>⇔185 ⇨185 mm</b>	1.950 lm		incl. 1x17,5 W	└─┘45-70 mm	└─┘50-160 mm	EAN 4000870 930656	<b>930.65</b>
	<b>ø215 mm</b>	2.450 lm		incl. 1x22 W	└─┘45-70 mm	└─┘50-190 mm	EAN 4000870 930687	<b>930.68</b>
	<b>⇔215 ⇨215 mm</b>	2.450 lm		incl. 1x22 W	└─┘45-70 mm	└─┘50-190 mm	EAN 4000870 930663	<b>930.66</b>





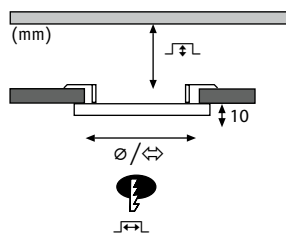
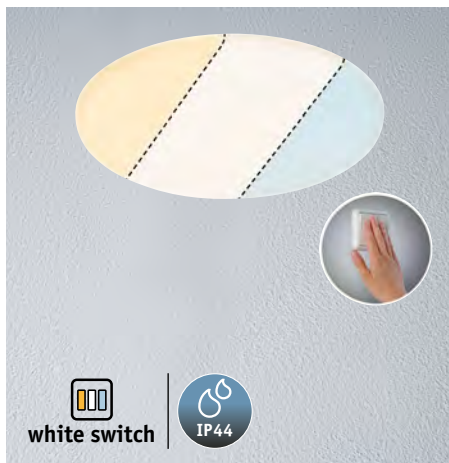
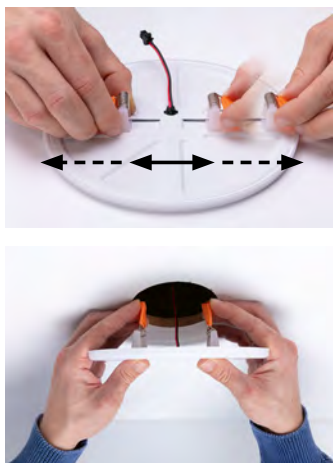

**Veluna VariFit** Plastic Plástico Plástica

white switch = 3.000 - 4.000 K - 6.500 K

	<b>ø185 mm</b>	1.500 lm		incl. 1×14 W	↕ 45-70 mm	↕ 60-160 mm	EAN 4000870 953815	<b>953.81</b>
	<b>⇄185 ⇄185 mm</b>	1.500 lm		incl. 1×14 W	↕ 45-70 mm	↕ 60-160 mm	EAN 4000870 953792	<b>953.79</b>
	<b>ø215 mm</b>	1.900 lm		incl. 1×17 W	↕ 45-70 mm	↕ 60-190 mm	EAN 4000870 953822	<b>953.82</b>
	<b>⇄215 ⇄215 mm</b>	1.900 lm		incl. 1×17 W	↕ 45-70 mm	↕ 60-190 mm	EAN 4000870 953808	<b>953.80</b>

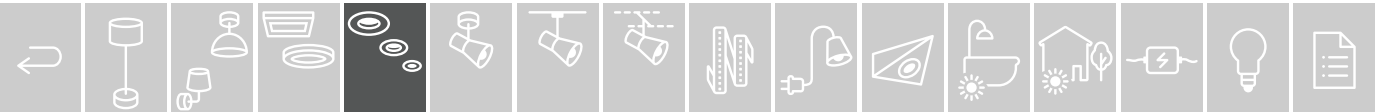

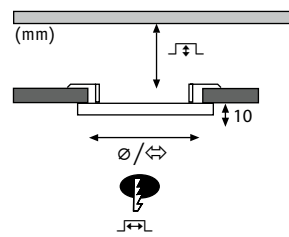
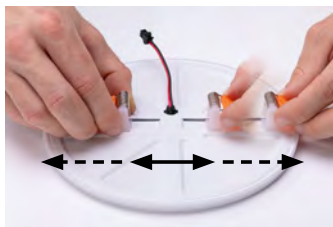

**Veluna VariFit** Plastic Plástico Plastica

tunable white = 3.000 - 6.500 K

	ø185 mm		↔185 ↗185 mm		ø215 mm		↔215 ↗215 mm	
	1.600 lm	incl. 1x15 W	└┘75-110 mm	└┘60-160 mm	EAN 4000870 953860	<b>953.86</b>		
	1.600 lm	incl. 1x15 W	└┘75-110 mm	└┘60-160 mm	EAN 4000870 953846	<b>953.84</b>		
	1.900 lm	incl. 1x17 W	└┘75-110 mm	└┘60-190 mm	EAN 4000870 953877	<b>953.87</b>		
	1.900 lm	incl. 1x17 W	└┘75-110 mm	└┘60-190 mm	EAN 4000870 953853	<b>953.85</b>		



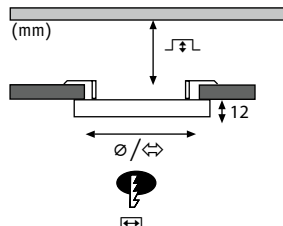
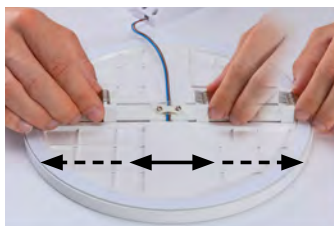

**Areo VariFit** Plastic Plástico Plastica

**warm white = 3.000 K**

**ø118 mm**



<b>W</b>	850 lm	incl. 1x6,5 W	45-95 mm	50-85 mm	EAN 4000870 930311	<b>930.31</b>
<b>CM</b>	850 lm	incl. 1x6,5 W	45-95 mm	50-85 mm	EAN 4000870 930335	<b>930.33</b>



**⇔118 ⇨118 mm**

<b>W</b>	850 lm	incl. 1x6,5 W	45-95 mm	50-85 mm	EAN 4000870 930397	<b>930.39</b>
----------	--------	---------------	----------	----------	--------------------	---------------



**ø175 mm**

<b>W</b>	1.800 lm	incl. 1x13 W	45-70 mm	50-140 mm	EAN 4000870 930328	<b>930.32</b>
<b>CM</b>	1.800 lm	incl. 1x13 W	45-70 mm	50-140 mm	EAN 4000870 930342	<b>930.34</b>



**⇔175 ⇨175 mm**

<b>W</b>	1.800 lm	incl. 1x13 W	45-70 mm	50-140 mm	EAN 4000870 930403	<b>930.40</b>
----------	----------	--------------	----------	-----------	--------------------	---------------

**neutral white = 4.000 K**

**ø118 mm**



<b>W</b>	850 lm	incl. 1x6,5 W	45-95 mm	50-85 mm	EAN 4000870 930359	<b>930.35</b>
<b>CM</b>	850 lm	incl. 1x6,5 W	45-95 mm	50-85 mm	EAN 4000870 930373	<b>930.37</b>



**⇔118 ⇨118 mm**

<b>W</b>	850 lm	incl. 1x6,5 W	45-95 mm	50-85 mm	EAN 4000870 930410	<b>930.41</b>
----------	--------	---------------	----------	----------	--------------------	---------------



**ø175 mm**

<b>W</b>	1.800 lm	incl. 1x13 W	45-70 mm	50-140 mm	EAN 4000870 930366	<b>930.36</b>
<b>CM</b>	1.800 lm	incl. 1x13 W	45-70 mm	50-140 mm	EAN 4000870 930380	<b>930.38</b>



**⇔175 ⇨175 mm**

<b>W</b>	1.800 lm	incl. 1x13 W	45-70 mm	50-140 mm	EAN 4000870 930427	<b>930.42</b>
----------	----------	--------------	----------	-----------	--------------------	---------------

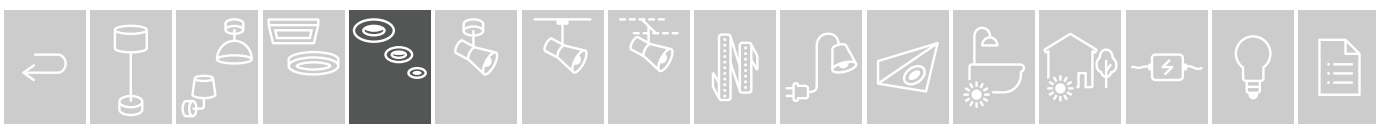

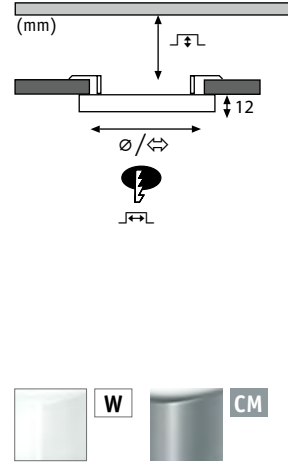
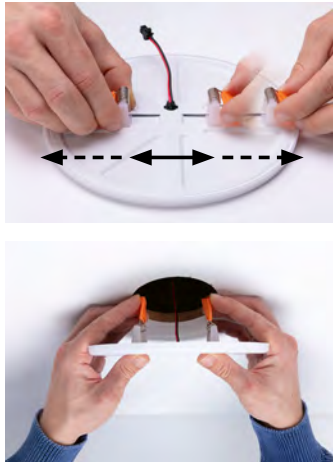

**Areo VariFit** Plastic Plástico Plástica

warm white = 3.000 K

ø175 mm							
	<b>W</b>	1.800 lm	incl. 1×13 W	↕ 45-70 mm	↕ 50-140 mm	EAN 4000870 930496	<b>930.49</b>
	<b>CM</b>	1.800 lm	incl. 1×13 W	↕ 45-70 mm	↕ 50-140 mm	EAN 4000870 930519	<b>930.51</b>
↔175 ↔175 mm							
	<b>W</b>	1.800 lm	incl. 1×13 W	↕ 45-70 mm	↕ 50-140 mm	EAN 4000870 930533	<b>930.53</b>
ø230 mm							
	<b>W</b>	2.200 lm	incl. 1×16 W	↕ 45-70 mm	↕ 50-195 mm	EAN 4000870 930502	<b>930.50</b>
	<b>CM</b>	2.200 lm	incl. 1×16 W	↕ 45-70 mm	↕ 50-195 mm	EAN 4000870 930526	<b>930.52</b>
↔230 ↔230 mm							
	<b>W</b>	2.200 lm	incl. 1×16 W	↕ 45-70 mm	↕ 50-195 mm	EAN 4000870 930540	<b>930.54</b>

neutral white = 4.000 K

ø175 mm							
	<b>W</b>	1.800 lm	incl. 1×13 W	↕ 45-70 mm	↕ 50-140 mm	EAN 4000870 930557	<b>930.55</b>
	<b>CM</b>	1.800 lm	incl. 1×13 W	↕ 45-70 mm	↕ 50-140 mm	EAN 4000870 930571	<b>930.57</b>
↔175 ↔175 mm							
	<b>W</b>	1.800 lm	incl. 1×13 W	↕ 45-70 mm	↕ 50-140 mm	EAN 4000870 930595	<b>930.59</b>
ø230 mm							
	<b>W</b>	2.200 lm	incl. 1×16 W	↕ 45-70 mm	↕ 50-195 mm	EAN 4000870 930564	<b>930.56</b>
	<b>CM</b>	2.200 lm	incl. 1×16 W	↕ 45-70 mm	↕ 50-195 mm	EAN 4000870 930588	<b>930.58</b>
↔230 ↔230 mm							
	<b>W</b>	2.200 lm	incl. 1×16 W	↕ 45-70 mm	↕ 50-195 mm	EAN 4000870 930601	<b>930.60</b>



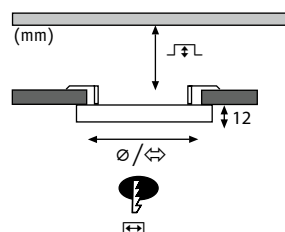
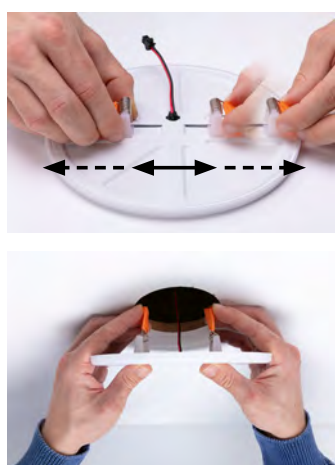

**Areo VariFit** Plastic Plástico Plastica

3 step dim to warm = 2.000 - 4.000 K



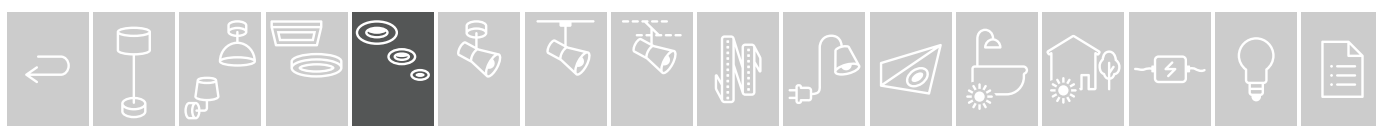

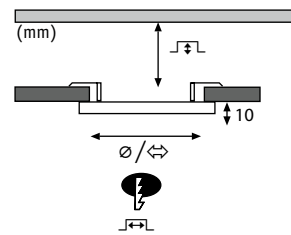
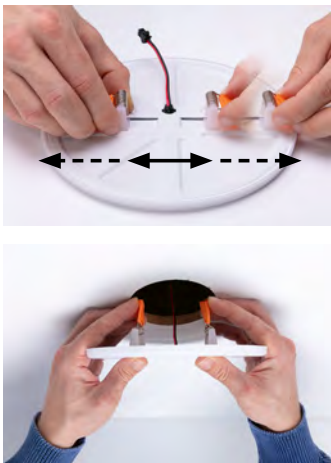
	ø175 mm							
	<b>W</b>	1.700 lm		incl. 1×13 W	↙↘45-70 mm	↙↘50-140 mm	EAN 4000870 929896	<b>929.89</b>
	<b>CM</b>	1.700 lm		incl. 1×13 W	↙↘45-70 mm	↙↘50-140 mm	EAN 4000870 929919	<b>929.91</b>
	⇔175 ⇔175 mm							
	<b>W</b>	1.800 lm		incl. 1×13 W	↙↘45-70 mm	↙↘50-140 mm	EAN 4000870 929933	<b>929.93</b>
	ø230 mm							
	<b>W</b>	2.000 lm		incl. 1×16 W	↙↘45-70 mm	↙↘50-195 mm	EAN 4000870 929902	<b>929.90</b>
	<b>CM</b>	2.000 lm		incl. 1×16 W	↙↘45-70 mm	↙↘50-140 mm	EAN 4000870 929926	<b>929.92</b>
	⇔230 ⇔230 mm							
	<b>W</b>	2.200 lm		incl. 1×16 W	↙↘45-70 mm	↙↘50-195 mm	EAN 4000870 929940	<b>929.94</b>





**Areo VariFit** Plastic Plástico Plastica

 tunable white = 3.000 - 6.500 K

	ø175 mm							
	<b>W</b>	1.700 lm		incl. 1×13 W	∩L45-85 mm	∩L50-140 mm	EAN 4000870 930434	<b>930.43</b>
	<b>CM</b>	1.700 lm		incl. 1×13 W	∩L45-85 mm	∩L50-140 mm	EAN 4000870 930458	<b>930.45</b>
	⇄175 ⇄175 mm							
	<b>W</b>	1.800 lm		incl. 1×13 W	∩L45-85 mm	∩L50-140 mm	EAN 4000870 930472	<b>930.47</b>
	ø230 mm							
	<b>W</b>	2.000 lm		incl. 1×16 W	∩L45-85 mm	∩L50-195 mm	EAN 4000870 930441	<b>930.44</b>
	<b>CM</b>	2.000 lm		incl. 1×16 W	∩L45-85 mm	∩L50-195 mm	EAN 4000870 930465	<b>930.46</b>
	⇄230 ⇄230 mm							
	<b>W</b>	2.200 lm		incl. 1×16 W	∩L45-85 mm	∩L50-195 mm	EAN 4000870 930489	<b>930.48</b>

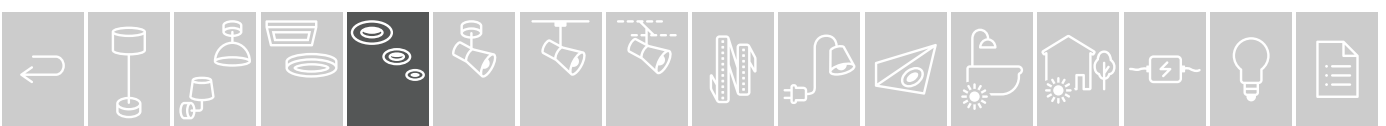

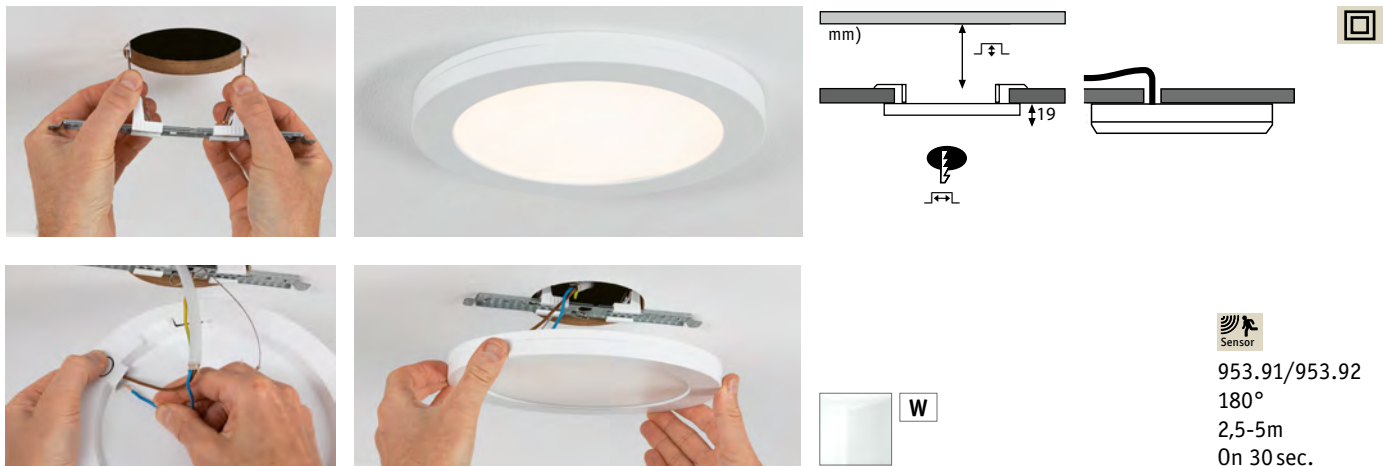

953.91/953.92  
180°  
2,5-5m  
On 30sec.

**2in1 Cover-it Panels new** Plastic Plástico Plastica

neutral white = 4.000 K

	<b>ø225 mm</b>		1.800 lm		incl. 1×16,5 W	└┘35 mm	└┘50-180 mm	EAN 4000870 953914	<b>953.91</b>
	<b>ø330 mm</b>		2.460 lm		incl. 1×22 W	└┘35 mm	└┘50-180 mm	EAN 4000870 953921	<b>953.92</b>
	<b>ø225 mm</b>		1.800 lm		incl. 1×16,5 W	└┘35 mm	└┘50-180 mm	EAN 4000870 953891	<b>953.89</b>
	<b>ø330 mm</b>		2.460 lm		incl. 1×22 W	└┘35 mm	└┘50-180 mm	EAN 4000870 953907	<b>953.90</b>

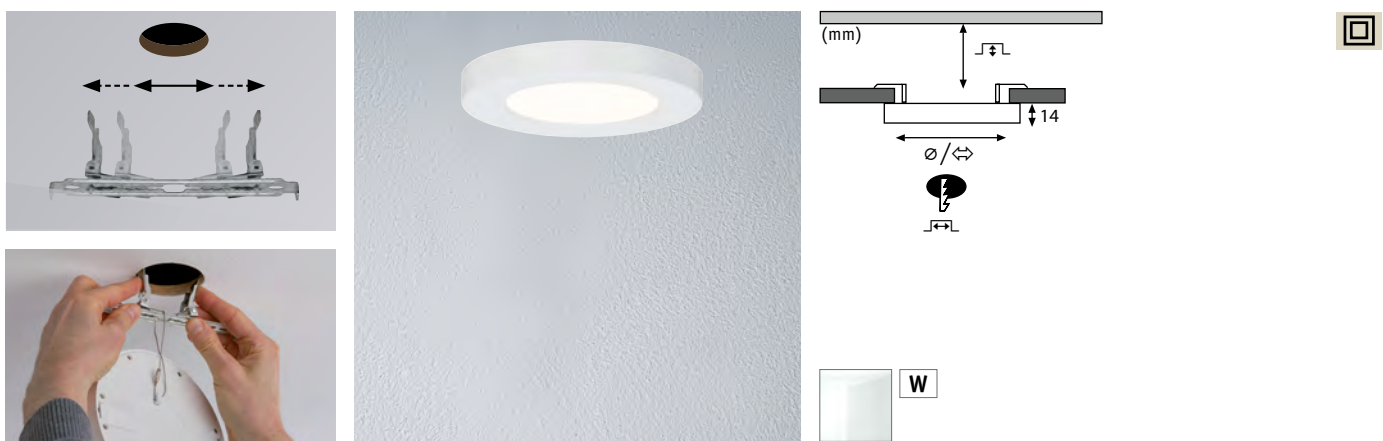

**Cover-it Panel** Plastic Plástico Plastica

warm white = 3.000 K

	<b>ø116 mm</b>		700 lm		incl. 1×6 W	└┘35 mm	└┘55-100 mm	EAN 4000870 037256	<b>3725</b>
	<b>ø165 mm</b>		1.400 lm		incl. 1×12 W	└┘35 mm	└┘55-125 mm	EAN 4000870 037263	<b>3726</b>

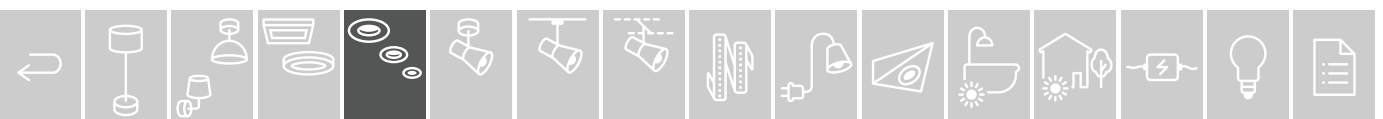

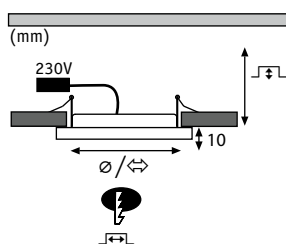

**Panel Areo dimmable**

Plastic Plástico Plastica

- ▶ Splash-protected (IP44)
- ▶ Suitable for installation in bathrooms
- ▶ Protección contra salpicaduras de agua (IP44)
- ▶ Adecuado para en el baño
- ▶ Protezione dagli spruzzi d'acqua (IP44)
- ▶ Per l'installazione in bagno

warm white = 3.000 K



**ø120 mm**

<b>W</b>	830 lm		incl. 1×8 W	└─┘35 mm	└─┘105 mm	EAN 4000870 929346	<b>929.34</b>
<b>NM</b>	830 lm		incl. 1×8 W	└─┘35 mm	└─┘105 mm	EAN 4000870 929360	<b>929.36</b>



**⇔120 ⇔120 mm**

<b>W</b>	830 lm		incl. 1×8 W	└─┘35 mm	└─┘105x105 mm	EAN 4000870 929384	<b>929.38</b>
<b>NM</b>	830 lm		incl. 1×8 W	└─┘35 mm	└─┘105x105 mm	EAN 4000870 929407	<b>929.40</b>



**ø180 mm**

<b>W</b>	1.300 lm		incl. 1×12 W	└─┘35 mm	└─┘155 mm	EAN 4000870 929339	<b>929.33</b>
<b>NM</b>	1.300 lm		incl. 1×12 W	└─┘35 mm	└─┘155 mm	EAN 4000870 929353	<b>929.35</b>



**⇔180 ⇔180 mm**

<b>W</b>	1.300 lm		incl. 1×12 W	└─┘35 mm	└─┘155x155 mm	EAN 4000870 929377	<b>929.37</b>
<b>NM</b>	1.300 lm		incl. 1×12 W	└─┘35 mm	└─┘155x155 mm	EAN 4000870 929391	<b>929.39</b>

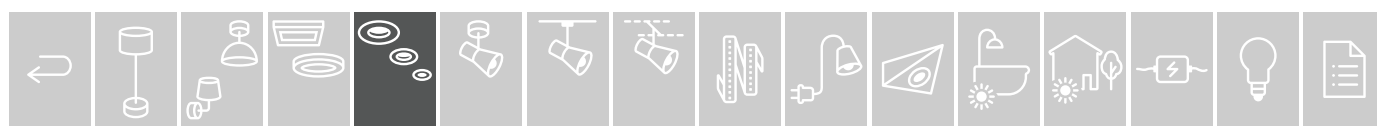



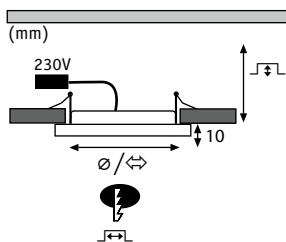

**Panel Areo IP23** Plastic Plástico Plastica

● warm white = 3.000 K



**ø80 mm**

<b>W</b>	615 lm		incl. 1×5 W	↵35 mm	↵75 mm	EAN 4000870 929452		<b>929.45</b>
<b>NM</b>	615 lm		incl. 1×5 W	↵35 mm	↵75 mm	EAN 4000870 929483		<b>929.48</b>



**↔80 ↔80 mm**

<b>W</b>	615 lm		incl. 1×5 W	↵35 mm	↵72x72 mm	EAN 4000870 929513		<b>929.51</b>
<b>NM</b>	615 lm		incl. 1×5 W	↵35 mm	↵72x72 mm	EAN 4000870 929544		<b>929.54</b>



**ø120 mm**

<b>W</b>	920 lm		incl. 1×8 W	↵35 mm	↵105 mm	EAN 4000870 929445		<b>929.44</b>
<b>NM</b>	920 lm		incl. 1×8 W	↵35 mm	↵105 mm	EAN 4000870 929476		<b>929.47</b>



**↔120 ↔120 mm**

<b>W</b>	920 lm		incl. 1×8 W	↵35 mm	↵105x105 mm	EAN 4000870 929506		<b>929.50</b>
<b>NM</b>	920 lm		incl. 1×8 W	↵35 mm	↵105x105 mm	EAN 4000870 929537		<b>929.53</b>



**ø180 mm**

<b>W</b>	1.350 lm		incl. 1×12 W	↵35 mm	↵155 mm	EAN 4000870 929438		<b>929.43</b>
<b>NM</b>	1.350 lm		incl. 1×12 W	↵35 mm	↵155 mm	EAN 4000870 929469		<b>929.46</b>



**↔180 ↔180 mm**

<b>W</b>	1.350 lm		incl. 1×12 W	↵35 mm	↵155x155 mm	EAN 4000870 929490		<b>929.49</b>
<b>NM</b>	1.350 lm		incl. 1×12 W	↵35 mm	↵155x155 mm	EAN 4000870 929520		<b>929.52</b>

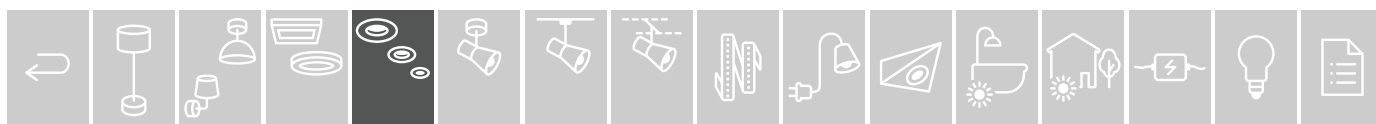

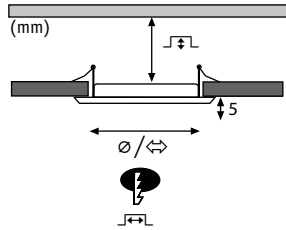

**Quality Line Panel IP44** Plastic Plástico Plastica

warm white = 2.700 K

**ø170 mm**



<b>W</b>	1.118 lm		incl. 1×12 W	↴35 mm	↴150 mm	EAN 4000870 920626	<b>920.62</b>
<b>CM</b>	1.118 lm		incl. 1×12 W	↴35 mm	↴150 mm	EAN 4000870 920749	<b>920.74</b>

**↔165 ↻165 mm**



<b>W</b>	1.119 lm		incl. 1×12 W	↴35 mm	↴155×155 mm	EAN 4000870 920688	<b>920.68</b>
<b>CM</b>	1.119 lm		incl. 1×12 W	↴35 mm	↴155×155 mm	EAN 4000870 920800	<b>920.80</b>

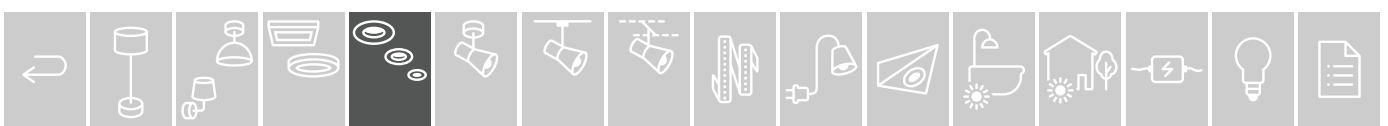

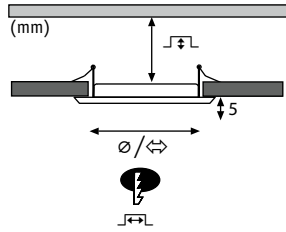

**Quality Line Panel IP44** Plastic Plástico Plastica

neutral white = 4.000 K

**ø115 mm**



<b>W</b>	671 lm		incl. 1×6 W	↴35 mm	↴100 mm	EAN 4000870 920589	<b>920.58</b>
<b>CM</b>	671 lm		incl. 1×6 W	↴35 mm	↴100 mm	EAN 4000870 920701	<b>920.70</b>

**↔115 ↻115 mm**



<b>W</b>	671 lm		incl. 1×6 W	↴35 mm	↴105x105 mm	EAN 4000870 920640	<b>920.64</b>
<b>CM</b>	671 lm		incl. 1×6 W	↴35 mm	↴105x105 mm	EAN 4000870 920763	<b>920.76</b>

**ø170 mm**



<b>W</b>	1.262 lm		incl. 1×12 W	↴35 mm	↴150 mm	EAN 4000870 920596	<b>920.59</b>
<b>CM</b>	1.262 lm		incl. 1×12 W	↴35 mm	↴150 mm	EAN 4000870 920718	<b>920.71</b>

**↔165 ↻165 mm**



<b>W</b>	1.263 lm		incl. 1×12 W	↴35 mm	↴155x155 mm	EAN 4000870 920657	<b>920.65</b>
<b>CM</b>	1.263 lm		incl. 1×12 W	↴35 mm	↴155x155 mm	EAN 4000870 920770	<b>920.77</b>

**ø220 mm**



<b>W</b>	2.011 lm		incl. 1×18 W	↴35 mm	↴200 mm	EAN 4000870 920602	<b>920.60</b>
<b>CM</b>	2.011 lm		incl. 1×18 W	↴35 mm	↴200 mm	EAN 4000870 920725	<b>920.72</b>

**↔220 ↻220 mm**



<b>W</b>	2.011 lm		incl. 1×16,5 W	↴35 mm	↴205x205 mm	EAN 4000870 920664	<b>920.66</b>
<b>CM</b>	2.011 lm		incl. 1×16,5 W	↴35 mm	↴205x205 mm	EAN 4000870 920787	<b>920.78</b>



Combine your own personal lighting system

Combine usted mismo su sistema de luz personal

Scegliete voi stessi le combinazioni per il vostro sistema d'illuminazione personalizzato

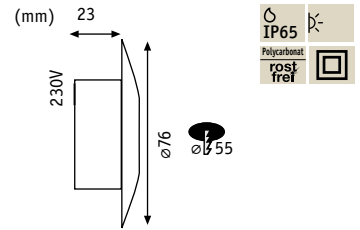
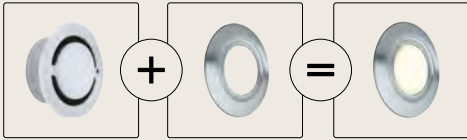

**IP65 Downlight Basic**

Polycarbonate Policarbonato Policarbonato

- ▶ Toolless mounting of stainless-steel decor by Velcro strip
- ▶ Assembly possible directly in 60 mm recessed sockets

- ▶ Se complementa con embellecedor de acero de ley
- ▶ Es posible montarlo directamente en cajas de enchufe de 60 mm

- ▶ Rifinito con copertura in acciaio inox
- ▶ Possibilità di montaggio diretto in scatole da incasso da 60 mm

Opal Opal Opale



**incl. 1x1,4 W**  
3.000 K  
230 V  
EAN 4000870 937402  
**937.40**

Opal Opal Opale



**incl. 1x1,4 W**  
4.000 K  
230 V  
EAN 4000870 937419  
**937.41**

Stainless steel Acero inoxidable Acciaio legato

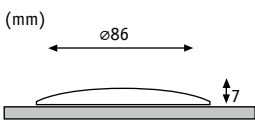

Stainless steel  
Acero inoxidable Acciaio legato

**Cover round**

7 Ø86 mm  
EAN 4000870 937426  
**937.42**

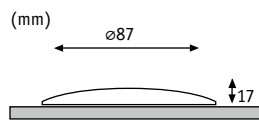

Stainless steel  
Acero inoxidable Acciaio legato

**Cover Cap round**

17 Ø87 mm  
EAN 4000870 937433  
**937.43**

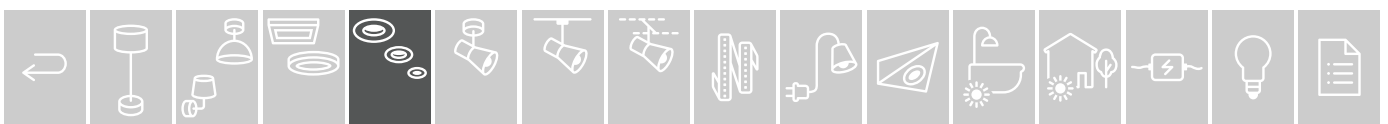
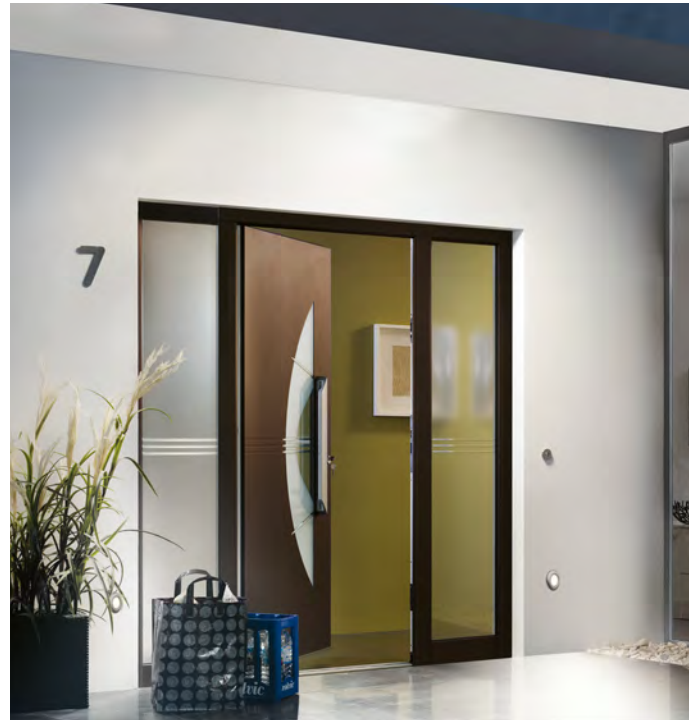

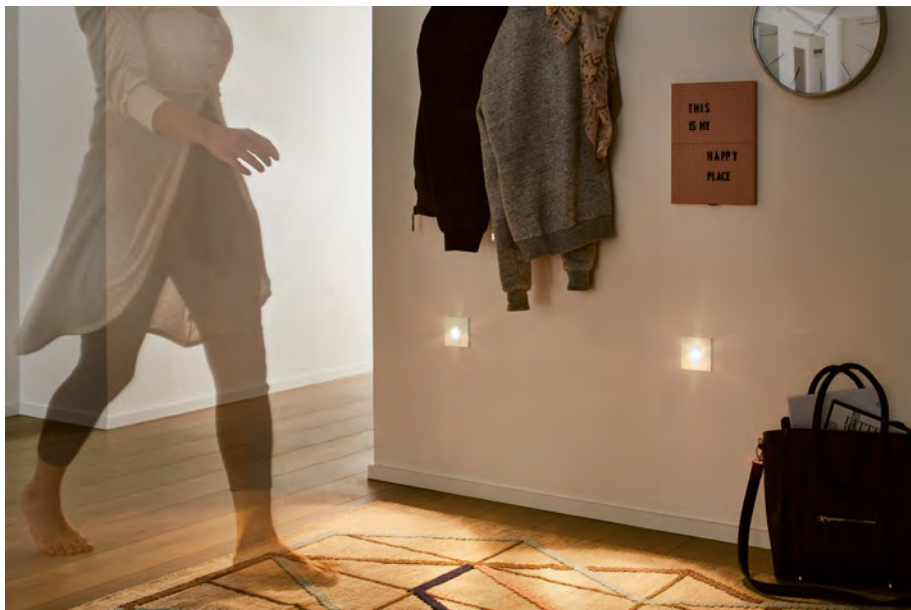

**Wall 230V** Plastic Plástico Plastica

- ▶ 230V wall light
- ▶ Suitable for standard cavity wall boxes
- ▶ Luminaria de pared 230 V
- ▶ Adecuado para cajas para paredes huecas habituales
- ▶ Luce da parete da 230V
- ▶ Idoneo per le comuni prese parete cava

White Blanco Bianco

**incl. 1x1,1 W**  
 110 lm, 2.700 K  
 <math>\sphericalangle 67^\circ</math>  
 230V  
 EAN 4000870 929223  
**929.22**

White Blanco Bianco

**incl. 1x1,1 W**  
 110 lm, 2.700 K  
 <math>\sphericalangle 67^\circ</math>  
 230V  
 EAN 4000870 929247  
**929.24**

**Wall 230V** Plastic Plástico Plastica

- ▶ 230V wall light
- ▶ Motion detector
- ▶ Suitable for standard cavity wall boxes
- ▶ Luminaria de pared 230 V
- ▶ Adecuado para cajas para paredes huecas habituales
- ▶ Luce da parete da 230V
- ▶ Idoneo per le comuni prese parete cava

White Blanco Bianco

**incl. 1x1,1 W**  
 100 lm, 2.700 K  
 <math>\sphericalangle 72^\circ</math>  
 230V  
 EAN 4000870 929230  
**929.23**

White Blanco Bianco

**incl. 1x2,7 W**  
 100 lm, 2.700 K  
 <math>\sphericalangle 72^\circ</math>  
 230V  
 EAN 4000870 929254  
**929.25**

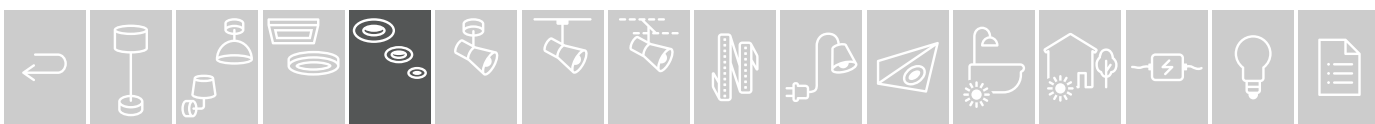

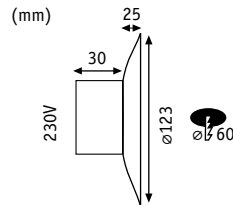

**Wall Neordic adjustable 230V**

Plastic Plástico Plastica

- ▶ Moving decorative plate deflects the light
- ▶ Installation directly in cavity wall boxes possible
- ▶ Suitable for Neordic living area luminaires
- ▶ Una placa decorativa móvil dirige la luz
- ▶ Se puede instalar directamente en cajas de paredes huecas
- ▶ Adecuado para lámparas para el hogar Neordic
- ▶ La piastra decorativa mobile orienta la luce
- ▶ Montaggio possibile direttamente nelle prese parete cava
- ▶ Adatto a luci per locali abitativi Neordic



🔑 Matt white Blanco mate Bianco opaco

**incl. 1x2,5 W**

180 lm, 2.700 K

230 V

EAN 4000870 929261

**929.26**

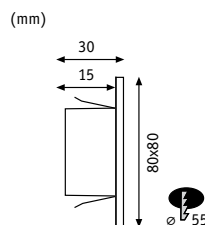
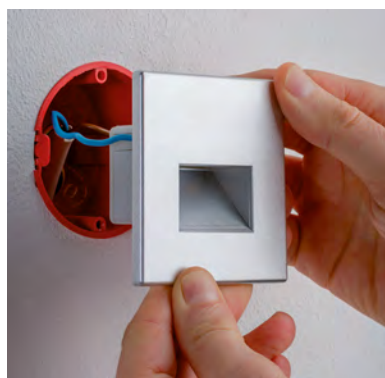

**Wall LED Edge**

Plastic Plástico Plastica

- ▶ Suitable for standard cavity wall boxes
- ▶ 230V wall light
- ▶ Adecuado para cajas para paredes huecas habituales
- ▶ Luminaria de pared 230 V
- ▶ Idoneo per le comuni prese parete cava
- ▶ Luce da parete da 230V



🔑 Chrome matt Cromo mate Cromo opaco

**incl. 1x1,1 W**

116 lm, 2.700 K

∠ 100°

230 V

EAN 4000870 994955

**994.95**

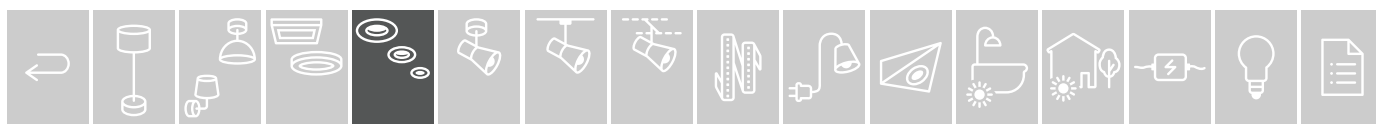

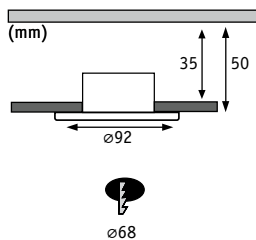
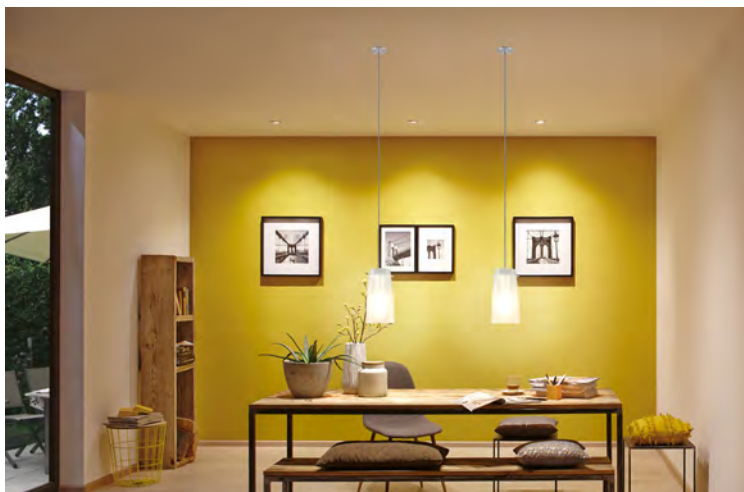
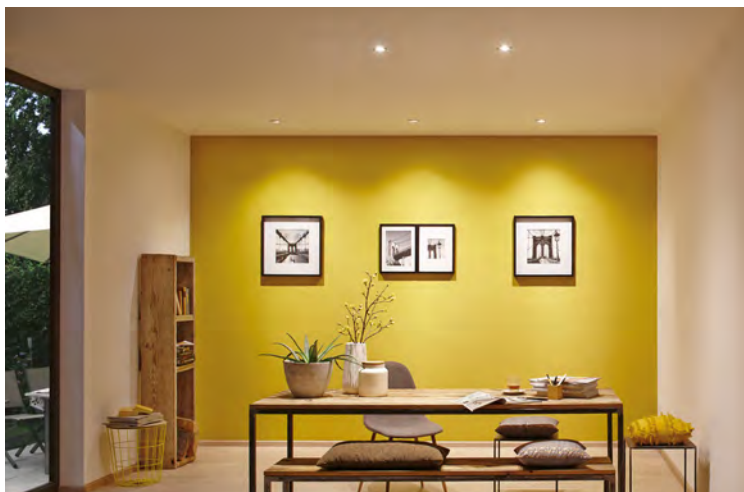

**Pendant Adapter**

☒ Metal/Plastic Metal/Plástico Metallo/Plastica

- ▶ Max. 3kg
- ▶ For cables with a max. diameter of 6.5mm
- ▶ Máx. 3 kg
- ▶ Para cables con un diámetro máx. de 6,5 mm
- ▶ Max. 3 kg
- ▶ Per cavi di diametro max. 6,5mm



🔗 Matt white Blanco mate Bianco opaco

EAN 4000870 924969  
**924.96**



🔗 Turned aluminium Aluminio torneado Alluminio tornito

EAN 4000870 924976  
**924.97**

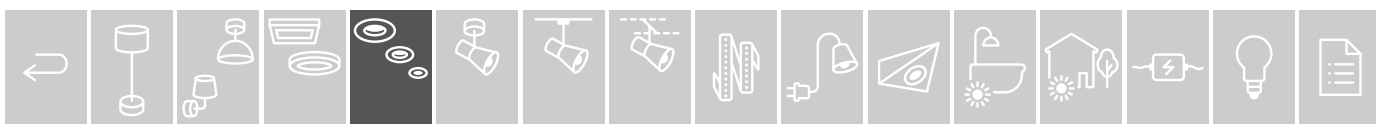

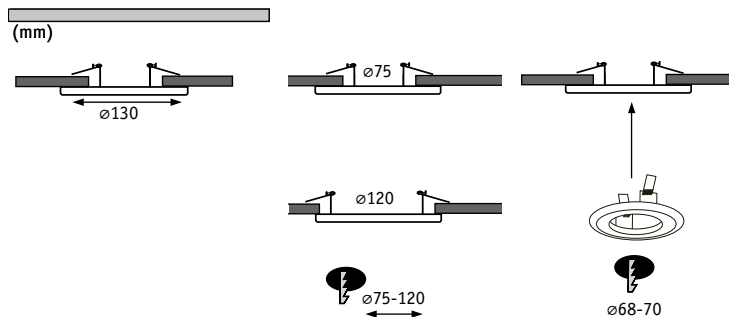

**Downlight adapter** Metal Metal Metallo

- ▶ Adapter ring for reducing the installation diameter
- ▶ For rigid and swivelling Paulmann recessed luminaires (installation diameter 68-70mm)
- ▶ Aro de adaptación para reducir el diámetro de montaje
- ▶ Para luminarias empotrables fijas y orientables Paulmann (diámetros de montaje 68-70 mm)
- ▶ Anello adattatore per ridurre il diametro di incasso
- ▶ Per apparecchi da incasso Paulmann fissi e orientabili (diametro di incasso 68-70 mm)

👉 Matt white Blanco mate Bianco opaco

👉 Brushed iron Hierro mateado Ferro spazzolato



**max. 50 W**  
EAN 4000870 924990  
**924.99** 📦



**max. 50 W**  
EAN 4000870 924983  
**924.98** 📦



**Recessed fitting** Carcasa incorporado Coppa da incasso Metal Metal Metallo

- ▶ The recessed installation pot is a perfect addition for the installation of swivelling recessed luminaires – simply attach it to the recessed luminaire to protect the luminaire and e.g. insulation materials.
- ▶ Socket included
- ▶ Connection with the help of a junction box
- ▶ La cavidad de montaje es el complemento ideal para la instalación de luminarias empotrables orientables; acoplada a la luminaria empotrable, sirve de protección tanto para la luminaria como para, p. ej., materiales aislantes.
- ▶ Portalámparas incluido
- ▶ Conexión con ayuda de una caja de empalmes
- ▶ La coppa da incasso è il complemento ideale per l'installazione di lampade a incasso orientabili: semplice da applicare sulla lampada da incasso protegge la lampada e ad es. i materiali isolanti.
- ▶ Attacco lampadina incluso
- ▶ Collegamento tramite scatola di collegamento

👉 Black Negro Nero

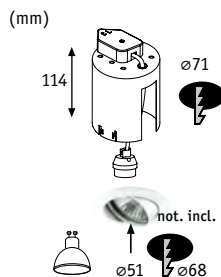

**max. 35 W**  
230 V  
EAN 4000870 002360  
**236** 📦





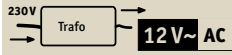

**12V, G4, GX5,3, GY6,35, GU5,3, GU4**

max. 50 W, G4 / GX5,3 / GY6,35

12 V

∅170 ↔15 ∇15 mm

EAN 4000870 002162

**216**

👉 White

👉 Blanco

👉 Bianco

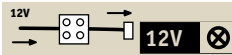

**12V, G4, GX5,3, GY6,35, GU5,3, GU4**

max. 75 W, G4 / GX5,3 / GY6,35

12 V

EAN 4000870 021897

**218.9**

👉 Ceramic natural

👉 Cerámica natural

👉 Ceramica naturale

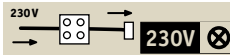

**230V GU10, GZ10**

GZ10

230 V

EAN 4000870 002179

**217**

👉 Ceramic natural

👉 Cerámica natural

👉 Ceramica naturale

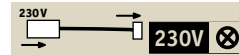

**230V GU10 Box**

max. 50 W, GU10

230 V

∅23 ↔70 ∇35 mm

EAN 4000870 938102

**938.10**

👉 Black Plastic

👉 Negro Plástico

👉 Nero Plastica

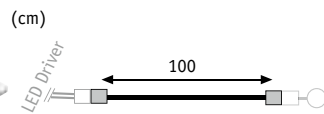
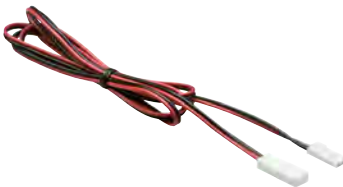
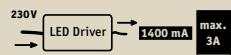
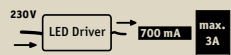
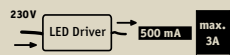
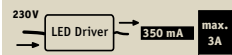

**Adapter JST 1x1m, 350, 500, 700, 1000, 1400mA (2x0,5mm<sup>2</sup>)**

∅1 m

EAN 4000870 002339

**233**



**Circlip (Plastic)**  
**Arandela de retención (Plástico)**  
**Anello elastico (Plastica)**



∅4 ∅50 ↔45 ∇45 mm

EAN 4000870 000274

**404001963**

**Circlip (Metal)**  
**Arandela de retención (Metal)**  
**Anello elastico (Metallo)**



∅35 mm

EAN 4000870 000267

**404000753**



∅51 mm

EAN 4000870 000250

**404000752**



3x

∅4 ∅51 ↔58 ∇50 mm

EAN 4000870 937617

**937.61**



∅51 mm

EAN 4000870 000236

**404000125**



3x

∅4 ∅51 ↔58 ∇52 mm

EAN 4000870 937624

**937.62**

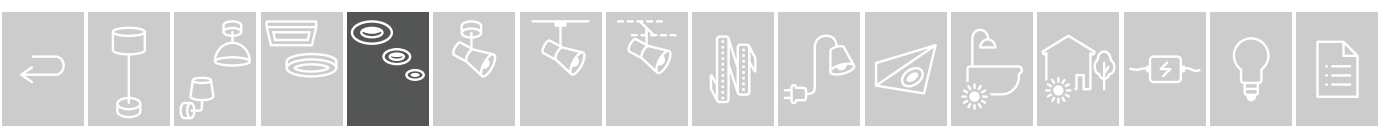

# Spotlights



□ = 146

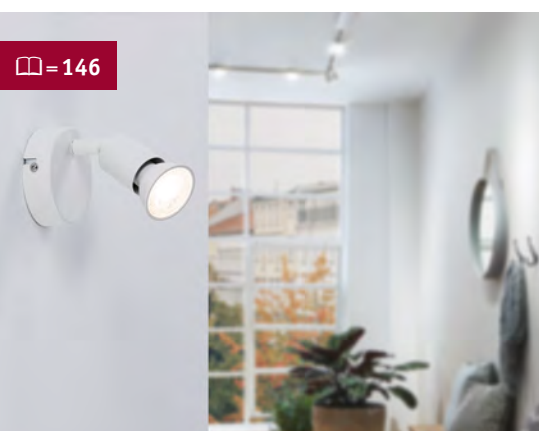

□ = 146



□ = 147



□ = 148





- 🌀 Matt white/Chrome 🗄 Metal
- 🌀 Blanco mate/Cromo 🗄 Metal
- 🌀 Bianco opaco/Cromo 🗄 Metallo

**Frame**

incl. 1×4,5 W  
468 lm, 3.000 K  
∠ 110°  
230 V  
⌀140 ⇄88 ↗131 mm  
EAN 4000870 666388  
**666.38**



On/Off

**Frame**

incl. 2×4,5 W  
2×468 lm, 3.000 K  
∠ 110°  
230 V  
⌀131 ⇄280 ↗100 mm  
EAN 4000870 666395  
**666.39**

**Frame**

incl. 3×4,5 W  
3×468 lm, 3.000 K  
∠ 110°  
230 V  
⌀131 ⇄430 ↗100 mm  
EAN 4000870 666401  
**666.40**

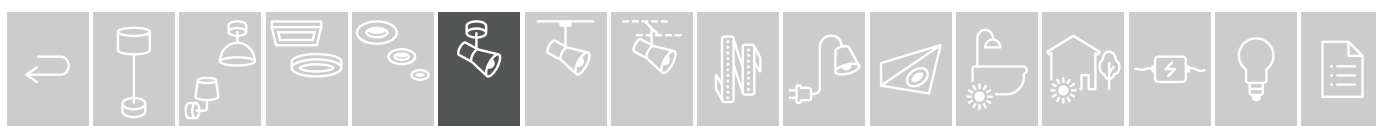



- 🎵 Nickel matt 📦 Metal
- 🎵 Níquel mate 📦 Metal
- 🎵 Nichel opaco 📦 Metallo



**Carolina**  
 max. 10W, GU10  
 230V  
 ⌀110 ⌀80 mm  
 EAN 4000870 667439  
**667.43**



**Carolina**  
 max. 2×10W, GU10  
 230V  
 ⌀124 ⇄305 ↗80 mm  
 EAN 4000870 667446  
**667.44**



**Carolina**  
 max. 3×10W, GU10  
 230V  
 ⌀124 ⇄482 ↗80 mm  
 EAN 4000870 667453  
**667.45**



**Carolina**  
 max. 4×10W, GU10  
 230V  
 ⌀124 ⇄584 ↗80 mm  
 EAN 4000870 667460  
**667.46**



- 🎵 Matt white 📦 Metal
- 🎵 Blanco mate 📦 Metal
- 🎵 Bianco opaco 📦 Metallo



Perfect match  
 ☐ = 424, 401



**Carolina**  
 max. 10W, GU10  
 230V  
 ⌀110 ⌀80 mm  
 EAN 4000870 667637  
**667.63 new**



**Carolina**  
 max. 2×10W, GU10  
 230V  
 ⌀124 ⇄305 ↗80 mm  
 EAN 4000870 667644  
**667.64 new**



**Carolina**  
 max. 3×10W, GU10  
 230V  
 ⌀124 ⇄428 ↗80 mm  
 EAN 4000870 667651  
**667.65 new**



**Carolina**  
 max. 4×10W, GU10  
 230V  
 ⌀124 ⇄584 ↗80 mm  
 EAN 4000870 667545  
**667.54 new**

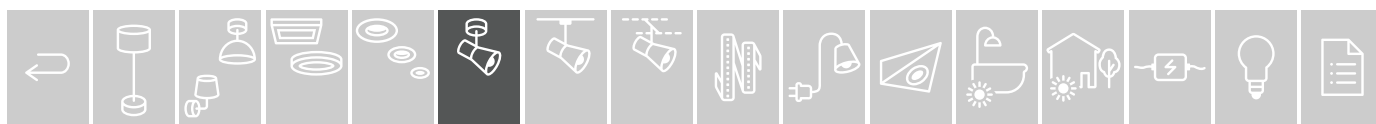



- 🌀 Black matt  Metal
- 🌀 Negro mate  Metal
- 🌀 Nero opaco  Metallo



Perfect match

☐ = 424, 401



#### Carolina

max. 10W, GU10  
230V  
⌀110 ⌀80 mm  
EAN 4000870 667552  
**667.55 new**



#### Carolina

max. 2×10W, GU10  
230V  
⌀124 ⇄305 ⌀80 mm  
EAN 4000870 667569  
**667.56 new**



#### Carolina

max. 3×10W, GU10  
230V  
⌀124 ⇄428 ⌀80 mm  
EAN 4000870 667576  
**667.57 new**



#### Carolina

max. 4×10W, GU10  
230V  
⌀124 ⇄584 ⌀80 mm  
EAN 4000870 667583  
**667.58 new**

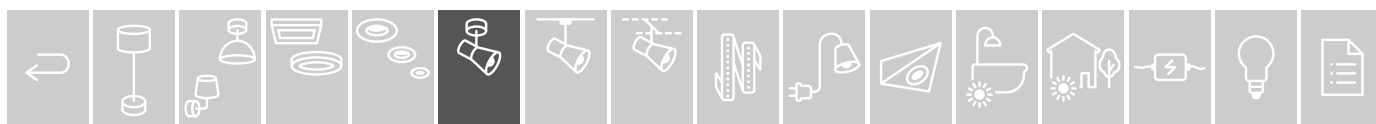



⌘ Black Metal  
 ⌘ Negro Metal  
 ⌘ Nero Metallo



Perfect match

= 409-411  
 427



**Davy**

max. 20 W, E27  
 230 V  
 ⌀140 ⇄112 ⤴147 mm  
 EAN 4000870 667590  
**667.59 new**



**Davy**

max. 2×20 W, E27  
 230 V  
 ⌀164 ⇄425 ⤴112 mm  
 EAN 4000870 667606  
**667.60 new**



**Davy**

max. 3×20 W, E27  
 230 V  
 ⌀164 ⇄625 ⤴112 mm  
 EAN 4000870 667613  
**667.61 new**



**Davy**

max. 4×20 W, E27  
 230 V  
 ⌀164 ⇄825 ⤴112 mm  
 EAN 4000870 667620  
**667.62 new**



⌘ Satin nickel Metal  
 ⌘ Níquel satinado Metal  
 ⌘ Nichel satinato Metallo



**Meli**

max. 2×10 W, GU10  
 230 V  
 ⌀160 ⇄260 ⤴55 mm  
 EAN 4000870 666876  
**666.87**



**Meli**

max. 3×10 W, GU10  
 230 V  
 ⌀160 ⇄400 ⤴55 mm  
 EAN 4000870 666883  
**666.88**



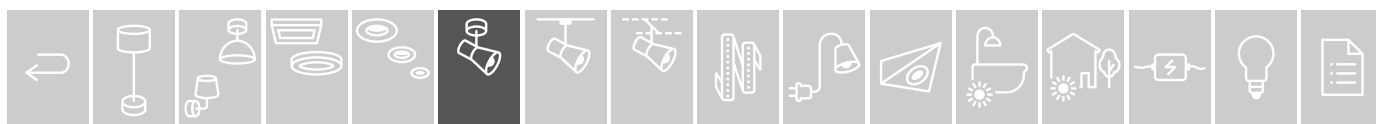

**Meli**

max. 4×10 W, GU10  
 230 V  
 ⌀160 ⇄600 ⤴55 mm  
 EAN 4000870 666890  
**666.89**





⌘ Satin nickel  Metal  
 ⌘ Níquel satinado  Metal  
 ⌘ Nichel satinato  Metallo

**Teja**

max. 10 W, GU10  
 230 V  
 ⌀100 ⇄52 ↗120 mm  
 EAN 4000870 666982  
**666.98**

**Teja**

max. 2×10 W, GU10  
 230 V  
 ⌀120 ⇄308 ↗52 mm  
 EAN 4000870 666999  
**666.99**



**Teja**

max. 3×10 W, GU10  
 230 V  
 ⌀120 ⇄500 ↗52 mm  
 EAN 4000870 667002  
**667.00**

**Teja**

max. 4×10 W, GU10  
 230 V  
 ⌀120 ⇄250 ↗250 mm  
 EAN 4000870 667019  
**667.01**



⌘ White  Metal  
 ⌘ Blanco  Metal  
 ⌘ Bianco  Metallo

**Teja**

max. 10 W, GU10  
 230 V  
 ⌀100 ⇄52 ↗120 mm  
 EAN 4000870 667026  
**667.02**

**Teja**

max. 2×10 W, GU10  
 230 V  
 ⌀120 ⇄308 ↗52 mm  
 EAN 4000870 667033  
**667.03**

**Teja**

max. 3×10 W, GU10  
 230 V  
 ⌀120 ⇄500 ↗52 mm  
 EAN 4000870 667040  
**667.04**

**Teja**

max. 4×10 W, GU10  
 230 V  
 ⌀120 ⇄250 ↗250 mm  
 EAN 4000870 667057  
**667.05**

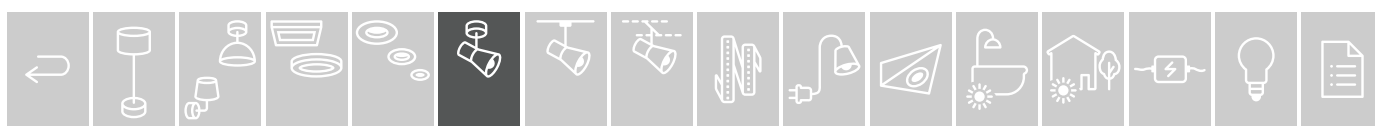

# Rail Systems

- 152 DecoSystems
- 154 Spots
- 166 Ceiling lamps |
- 168 Pendulum lamps
- 172 2Easy
- 174 Accessories |



## URail

### Your ideas, your light, your system

Distribute spot and Pendulum lights in your home with the URail light rail system. URail offers endless possibilities without complicated installation. All components can be combined and are quickly installed.

- ▶ For direct ceiling mounting, suspended or as an on-wall solution
- ▶ Plenty of flexibility with various accessories
- ▶ Easy switching and dimming – via remote control, voice or app

### Tus ideas, tu luz, tu sistema

Distribuye focos y lámparas colgantes por toda la casa con un raíl de iluminación. URail ofrece posibilidades infinitas sin necesidad de un complicado montaje. Todos los componentes se pueden combinar entre ellos y se instalan rápidamente.

- ▶ Para el montaje directo en el techo, colgado o en la pared
- ▶ Gran flexibilidad gracias a los múltiples accesorios
- ▶ Conmutación y regulación sencillas, también con mando a distancia, por voz o a través de la aplicación

### Le tue idee, la tua luce, il tuo sistema

Con un binario luminoso puoi distribuire spot e lampade a sospensione in tutto l'appartamento. URail offre innumerevoli possibilità di montaggio in modo del tutto semplice. Tutti i componenti si possono abbinare tra loro e installare rapidamente.

- ▶ Per il montaggio diretto a soffitto, nel controsoffitto o a parete
- ▶ Massima flessibilità attraverso diversi accessori
- ▶ Semplice commutazione e regolazione dell'intensità, anche tramite telecomando, comando vocale o app

EN Three easy steps to create a system

ES Crea tu sistema en tres sencillos pasos

IT Al sistema in tre semplici passaggi



EN 1. Choose rails

2. Choose feeds and connectors

3. Choose a spot or pendulum

Done!

ES 1. Selección de los raíles

2. Selección de los sistemas de alimentación y del conector

3. Selección del foco o péndulo

¡Listo!

IT 1. Selezionare i binari

2. Selezionare alimentazioni e connettori

3. Selezionare spot oppure sospensioni

Finito!

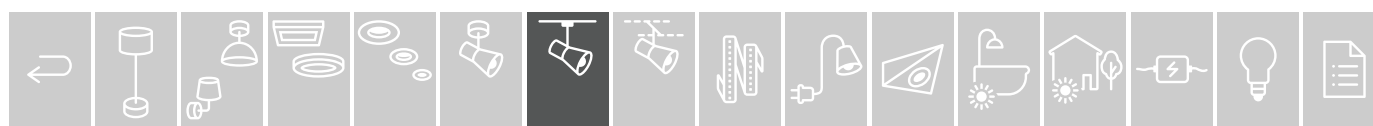





EN in stylish chrome matt  
 ES con estilo en cromo mate  
 IT in un raffinato cromo opaco



EN in timeless white  
 ES clásico en blanco  
 IT in un intramontabile bianco



EN in elegant black matt  
 ES elegante en negro mate  
 IT nell'elegante nero opaco

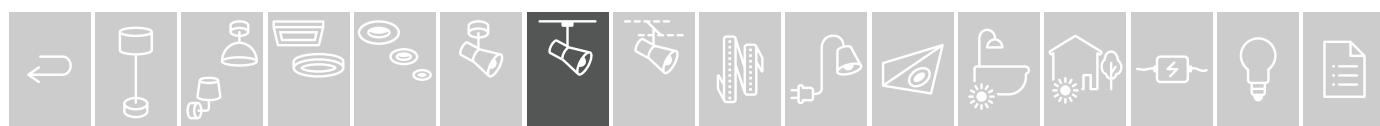

Combine your own personal lighting system  
 Combine usted mismo su sistema de luz personal  
 Scegliete voi stessi le combinazioni per il vostro sistema d'illuminazione personalizzato

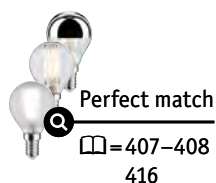
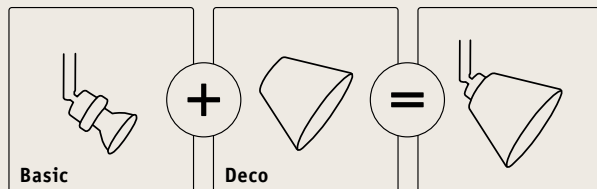

**Basic-Pendant**  
 max. 20 W, E14  
 230 V  
 ⤴ 135 cm ⌀44 mm  
 EAN 4000870 969694  
**969.69**  
 ☞ Chrome matt ☞ Metal/Plastic  
 ☞ Cromo mate ☞ Metal/Plástico  
 ☞ Cromo opaco ☞ Metallo/Plastica



**Basic-Spot**  
 max. 20 W, E14  
 230 V  
 ⤴ 163 ⌀44 mm  
 EAN 4000870 969687  
**969.68**  
 ☞ Chrome matt ☞ Metal/Plastic  
 ☞ Cromo mate ☞ Metal/Plástico  
 ☞ Cromo opaco ☞ Metallo/Plastica



**Basic-Pendant**  
 max. 20 W, E14  
 230 V  
 ⤴ 135 cm ⌀44 mm  
 EAN 4000870 969717  
**969.71**  
 ☞ White ☞ Metal/Plastic  
 ☞ Blanco ☞ Metal/Plástico  
 ☞ Bianco ☞ Metallo/Plastica



**Basic-Spot**  
 max. 20 W, E14  
 230 V  
 ⤴ 163 ⌀44 mm  
 EAN 4000870 969700  
**969.70**  
 ☞ White ☞ Metal/Plastic  
 ☞ Blanco ☞ Metal/Plástico  
 ☞ Bianco ☞ Metallo/Plastica



**Basic Pendant**  
 max. 20 W, E14  
 230 V  
 ⤴ 135 cm ⌀44 mm  
 EAN 4000870 969120  
**969.12**  
 ☞ Black matt ☞ Metal/Plastic  
 ☞ Negro mate ☞ Metal/Plástico  
 ☞ Nero opaco ☞ Metallo/Plastica



**Basic Spot**  
 max. 20 W, E14  
 230 V  
 ⤴ 163 ⌀44 mm  
 EAN 4000870 969137  
**969.13**  
 ☞ Black matt ☞ Metal/Plastic  
 ☞ Negro mate ☞ Metal/Plástico  
 ☞ Nero opaco ☞ Metallo/Plastica

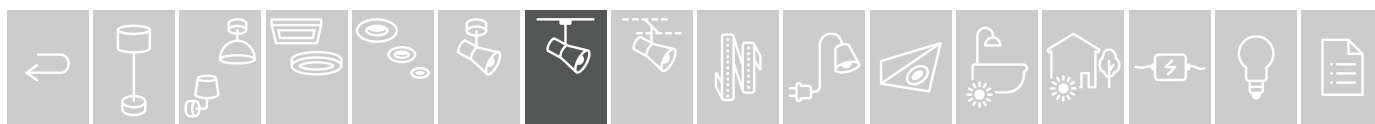

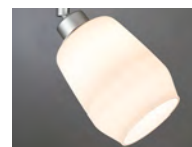

**Wolbi**

max. 50 W  
 ⚙️80 ø90 mm  
 EAN 4000870 600115  
**600.11**

- 🌀 Dichroic 🗍 Glass
- 🌀 Dicroico 🗍 Cristal
- 🌀 Dicroico 🗍 Vetro

**Vico**

max. 50 W  
 ⚙️95 ø80 mm  
 EAN 4000870 953570  
**953.57**

- 🌀 Clear 🗍 Glass
- 🌀 Transparente 🗍 Cristal
- 🌀 Trasparente 🗍 Vetro

**Twice**

max. 50 W  
 ⚙️70 ø100 mm  
 EAN 4000870 701744  
**701.74**

- 🌀 Clear/Opaque 🗍 Glass
- 🌀 Transparente/Opaco 🗍 Cristal
- 🌀 Trasparente/Opaco 🗍 Vetro

**Vento**

max. 50 W  
 ⚙️95 ø80 mm  
 EAN 4000870 953594  
**953.59**

- 🌀 Smoke glass 🗍 Glass
- 🌀 Vidrio ahumado 🗍 Cristal
- 🌀 Vetro opaco 🗍 Vetro

**Vento**

max. 50 W  
 ⚙️95 ø80 mm  
 EAN 4000870 953587  
**953.58**

- 🌀 Satin 🗍 Glass
- 🌀 Satinado 🗍 Cristal
- 🌀 Satinato 🗍 Vetro

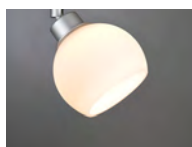

**Wolbi**

max. 50 W  
 ⚙️70 ø90 mm  
 EAN 4000870 600559  
**600.55**

- 🌀 Opal 🗍 Glass
- 🌀 Opal 🗍 Cristal
- 🌀 Opale 🗍 Vetro

**Quad**

max. 50 W  
 ⚙️80 ø75 mm  
 EAN 4000870 600153  
**600.15**

- 🌀 White 🗍 Glass
- 🌀 Blanco 🗍 Cristal
- 🌀 Bianco 🗍 Vetro

**Kegi**

max. 50 W  
 ⚙️80 ø110 mm  
 EAN 4000870 600122  
**600.12**

- 🌀 White 🗍 Glass
- 🌀 Blanco 🗍 Cristal
- 🌀 Bianco 🗍 Vetro

**Wolbi**

max. 50 W  
 ⚙️80 ø90 mm  
 EAN 4000870 600078  
**600.07**

- 🌀 White 🗍 Glass
- 🌀 Blanco 🗍 Cristal
- 🌀 Bianco 🗍 Vetro

**Zyli**

max. 50 W  
 ⚙️80 ø70 mm  
 EAN 4000870 600047  
**600.04**

- 🌀 White 🗍 Glass
- 🌀 Blanco 🗍 Cristal
- 🌀 Bianco 🗍 Vetro



**DecoSystems Diffusor**

max. 20 W  
 ⚙️1,5 ø255 mm  
 EAN 4000870 954935  
**954.93**

- 🌀 Satin 🗍 Plastic
- 🌀 Satinado 🗍 Plástico
- 🌀 Satinato 🗍 Plastica



**Tessa**

max. 50 W  
 ⚙️152 ø255 mm  
 EAN 4000870 603499  
**603.49**

- 🌀 Dark brown 🗍 Fabric
- 🌀 Marrón oscuro 🗍 Tela
- 🌀 Marrone scuro 🗍 Tessuto

**Tessa**

max. 50 W  
 ⚙️152 ø255 mm  
 EAN 4000870 603505  
**603.50**

- 🌀 Caramel 🗍 Fabric
- 🌀 Caramelo 🗍 Tela
- 🌀 Caramello 🗍 Tessuto

**Tessa**

max. 50 W  
 ⚙️152 ø255 mm  
 EAN 4000870 603512  
**603.51**

- 🌀 Cream 🗍 Fabric
- 🌀 Crema 🗍 Tela
- 🌀 Crema 🗍 Tessuto

**Tessa**

max. 50 W  
 ⚙️152 ø255 mm  
 EAN 4000870 603529  
**603.52**

- 🌀 Light grey 🗍 Fabric
- 🌀 Gris claro 🗍 Tela
- 🌀 Grigio chiaro 🗍 Tessuto

**Tessa**

max. 50 W  
 ⚙️152 ø255 mm  
 EAN 4000870 603260  
**603.26**

- 🌀 White 🗍 Fabric
- 🌀 Blanco 🗍 Tela
- 🌀 Bianco 🗍 Tessuto

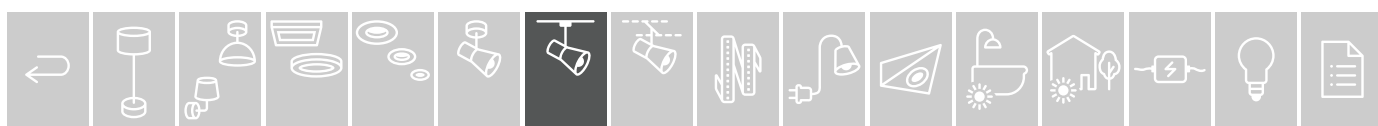

*Spots with non-replaceable LED dimmable*  
*Focos con LED fijo, regulables*  
*Spot con LED fijo dimmerabile*



**Spot Dipper**

incl. 2x8,1 W  
 2x670 lm, 2.700 K  
 ∠ 83°

230 V

∅170 ↔375 ↗26 mm

EAN 4000870 954690

**954.69**

- 🔗 Chrome matt/White 📦 Metal/Plastic
- 🔗 Cromo mate/Blanco 📦 Metal/Plástico
- 🔗 Cromo opaco/Bianco 📦 Metallo/Plastica



**Spot Sabik**

incl. 1x8,7 / 1x4,3 W  
 887 + 461 lm, 2.700 K  
 230 V

∅225 ∅117 ↗62 mm

EAN 4000870 949795

**949.79**

- 🔗 Matt white/Chrome matt
- 📦 Metal/Plastic
- 🔗 Blanco mate/Cromo mate
- 📦 Metal/Plástico
- 🔗 Bianco opaco/Cromo opaco
- 📦 Metallo/Plastica

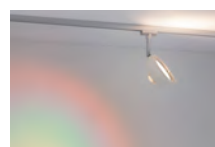
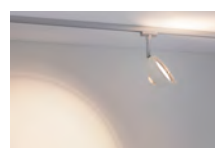

incl. dichroic foil

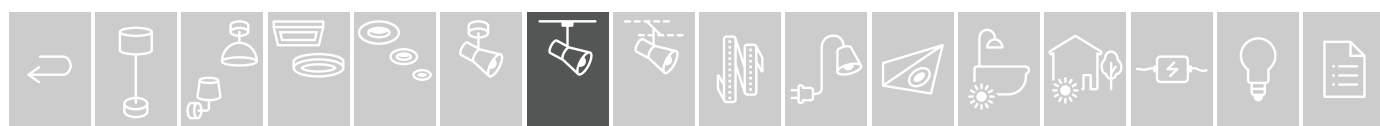



**Spot Arena**

incl. 1x9,9W  
1.180 lm, 2.700 K  
∠ 84°  
230 V  
∅191 ⇄123 ∅78 mm  
EAN 4000870 954461



**954.46**

- ☞ Chrome matt/Chrome ☐ Metal
- ☞ Cromo mate/Cromo ☐ Metal
- ☞ Cromo opaco/Cromo ☐ Metallo



**Spot Arena**

incl. 1x9,9W  
1.180 lm, 2.700 K  
∠ 84°  
230 V  
∅191 ⇄123 ∅78 mm  
EAN 4000870 954478



**954.47**

- ☞ White/Chrome ☐ Metal
- ☞ Blanco/Cromo ☐ Metal
- ☞ Bianco/Cromo ☐ Metallo



**Spot Arena**

incl. 1x9,9W  
1.050 lm, 2.700 K  
∠ 82°  
230 V  
∅191 ⇄123 ∅78 mm  
EAN 4000870 969243



**969.24**

- ☞ Black matt/Chrome ☐ Metal
- ☞ Negro mate/Cromo ☐ Metal
- ☞ Nero opaco/Cromo ☐ Metallo



**Spot Arena**

incl. 1x9,9W  
1.100 lm, 4.000 K  
∠ 82°  
230 V  
∅191 ⇄123 ∅78 mm  
EAN 4000870 969427



**969.42**

- ☞ Black matt/Chrome ☐ Metal
- ☞ Negro mate/Cromo ☐ Metal
- ☞ Nero opaco/Cromo ☐ Metallo



**Spot Aldan**

incl. 1x8W  
720 lm, 2.700 K  
∠ 65°  
230 V  
∅170 ∅98 mm  
EAN 4000870 955192



**955.19**

- ☞ Chrome matt/Black ☐ Metal/Plastic
- ☞ Cromo mate/Negro ☐ Metal/Plástico
- ☞ Cromo opaco/Nero ☐ Metallo/Plastica



**Spot Aldan**

incl. 1x8W  
720 lm, 2.700 K  
∠ 65°  
230 V  
∅170 ∅98 mm  
EAN 4000870 953952



**953.95 new**

- ☞ White/Black ☐ Metal
- ☞ Blanco/Negro ☐ Metal
- ☞ Bianco/Nero ☐ Metallo



**Spot Aldan**

incl. 1x8W  
720 lm, 2.700 K  
∠ 65°  
230 V  
∅170 ∅98 mm  
EAN 4000870 969274



**969.27**

- ☞ Black matt/Chrome ☐ Metal/Plastic
- ☞ Negro mate/Cromo ☐ Metal/Plástico
- ☞ Nero opaco/Cromo ☐ Metallo/Plastica



**Spot Focus**

incl. 1x7,4 W  
635 lm, 2.700 K  
∠ 45°  
230 V  
∅197 ⇄86 mm  
EAN 4000870 953730



**953.73**

- ☞ White/Chrome matt ☐ Metal/Plastic
- ☞ Blanco/Cromo mate ☐ Metal/Plástico
- ☞ Bianco/Cromo opaco ☐ Metallo/Plastica



**Spot Focus**

incl. 1x7,4 W  
635 lm, 2.700 K  
∠ 45°  
230 V  
∅197 ⇄86 mm  
EAN 4000870 953747



**953.74**

- ☞ Black/Chrome matt ☐ Metal/Plastic
- ☞ Negro/Cromo mate ☐ Metal/Plástico
- ☞ Nero/Cromo opaco ☐ Metallo/Plastica

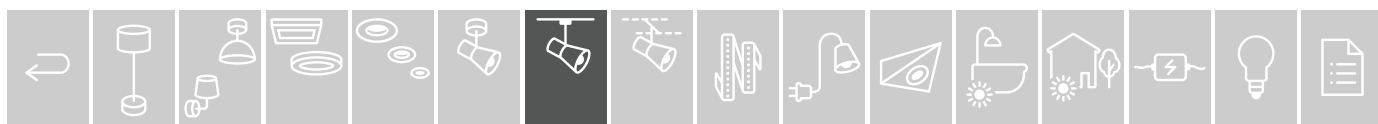



**Spot Cube**

incl. 1x8 W  
770 lm, 2.700 K  
∠ 65°

230 V  
⌀165 ⇄77 ⌀47 mm  
EAN 4000870 955109

**955.10**

- ☞ Chrome matt/Chrome ☒ Metal/Plastic
- ☞ Cromo mate/Cromo ☒ Metal/Plástico
- ☞ Cromo opaco/Cromo ☒ Metallo/Plastica



**Spot Cube**

incl. 1x8 W  
770 lm, 2.700 K  
∠ 65°

230 V  
⌀165 ⇄77 ⌀47 mm  
EAN 4000870 955116

**955.11**

- ☞ White/Chrome ☒ Metal/Plastic
- ☞ Blanco/Cromo ☒ Metal/Plástico
- ☞ Bianco/Cromo ☒ Metallo/Plastica



**Spot Cube**

incl. 1x8 W  
770 lm, 2.700 K  
∠ 65°

230 V  
⌀165 ⇄77 ⌀47 mm  
EAN 4000870 969236

**969.23**

- ☞ Black matt/Chrome ☒ Metal/Plastic
- ☞ Negro mate/Cromo ☒ Metal/Plástico
- ☞ Nero opaco/Cromo ☒ Metallo/Plastica



**Spot Cube**

incl. 1x8 W  
700 lm, 4.000 K  
∠ 65°

230 V  
⌀165 ⇄77 ⌀47 mm  
EAN 4000870 969410

**969.41**

- ☞ Black matt/Chrome ☒ Metal/Plastic
- ☞ Negro mate/Cromo ☒ Metal/Plástico
- ☞ Nero opaco/Cromo ☒ Metallo/Plastica

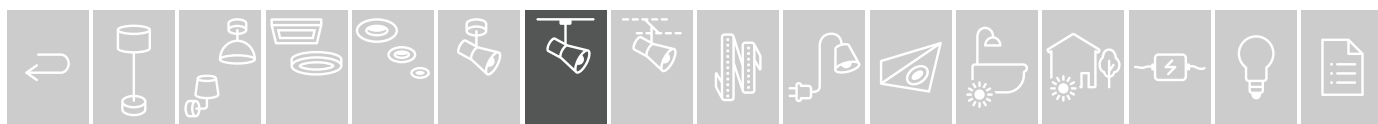



**Spot Sphere**

incl. 1x7 W  
635 lm, 2.700 K  
∠ 72°  
230 V  
∅183 ⇄119,8 ∅32 mm  
EAN 4000870 969366



**969.36**

- ☞ Chrome matt/Chrome
- ☞ Plastic
- ☞ Cromo mate/Cromo
- ☞ Cromo opaco/Cromo



**Spot Sphere**

incl. 1x7 W  
635 lm, 2.700 K  
∠ 72°  
230 V  
∅183 ⇄119,8 ∅32 mm  
EAN 4000870 969373



**969.37**

- ☞ White/Chrome
- ☞ Blanco/Cromo
- ☞ Bianco/Cromo



**Spot Sphere**

incl. 1x7 W  
635 lm, 2.700 K  
∠ 72°  
230 V  
∅183 ⇄119,8 ∅32 mm  
EAN 4000870 969380



**969.38**

- ☞ Black matt/Chrome
- ☞ Negro mate/Cromo
- ☞ Nero opaco/Cromo



**Spot Discus**

incl. 1x5,3 W  
440 lm, 2.700 K  
∠ 45°  
230 V  
∅215 ⇄29 ∅95 mm  
EAN 4000870 968918



**968.91**

- ☞ Chrome matt/Chrome
- ☞ Cromo mate/Cromo
- ☞ Cromo opaco/Cromo



**Spot Discus**

incl. 1x5,3 W  
440 lm, 2.700 K  
∠ 45°  
230 V  
∅215 ⇄29 ∅95 mm  
EAN 4000870 969229



**969.22**

- ☞ Black matt/Chrome
- ☞ Negro mate/Cromo
- ☞ Nero opaco/Cromo

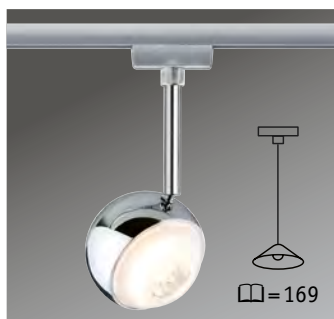

**Spot Capsule II**

incl. 1x6,3 W  
420 lm, 2.700 K  
∠ 30°  
230 V  
∅210 ⇄80 ∅80 mm  
EAN 4000870 954553



**954.55**

- ☞ Chrome matt/Chrome
- ☞ Cromo mate/Cromo
- ☞ Cromo opaco/Cromo

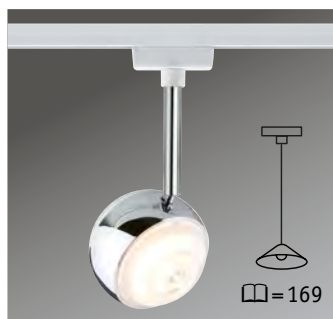

**Spot Capsule II**

incl. 1x6,3 W  
420 lm, 2.700 K  
∠ 30°  
230 V  
∅210 ⇄80 ∅80 mm  
EAN 4000870 954560



**954.56**

- ☞ White/Chrome
- ☞ Blanco/Cromo
- ☞ Bianco/Cromo



**Spot Double Pellet**

incl. 2x5,4 W  
2x370 lm, 2.700 K  
∠ 40°  
230 V  
∅180 ⇄190 ∅40 mm  
EAN 4000870 954713



**954.71**

- ☞ Chrome matt/White
- ☞ Cromo mate/Blanco
- ☞ Cromo opaco/Bianco



**Spot Pellet**

incl. 1x5,4 W  
370 lm, 2.700 K  
∠ 40°  
230 V  
∅180 ⇄80 ∅40 mm  
EAN 4000870 954737



**954.73**

- ☞ Chrome matt/White
- ☞ Cromo mate/Blanco
- ☞ Cromo opaco/Bianco



**Spot Pellet**

incl. 1x5,4 W  
370 lm, 2.700 K  
∠ 40°  
230 V  
∅180 ⇄80 ∅40 mm  
EAN 4000870 954744



**954.74**

- ☞ White/Chrome matt
- ☞ Blanco/Cromo mate
- ☞ Bianco/Cromo opaco

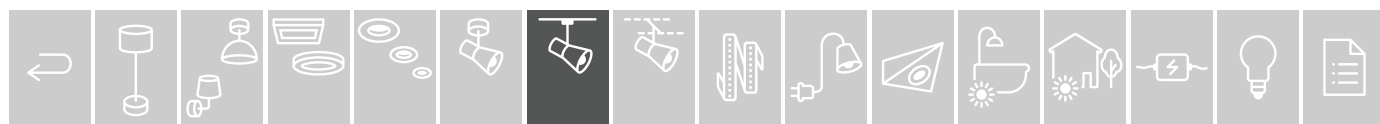





Spots with non-replaceable LED non-dimmable  
 Focos con LED fijo, no regulables  
 Spot con LED fijo non dimmerabile



**Spot Pedal**

incl. 1x5 W  
 395 lm, 2.700 K  
 <math>\sphericalangle 100^\circ</math>  
 230 V  
 $\varnothing 175 \times 50 \times 48$  mm  
 EAN 4000870 952696  
**952.69**



- Chrome matt Metal/Plastic
- Cromo mate Metal/Plástico
- Cromo opaco Metallo/Plastica

**Spot Pedal**

incl. 1x5 W  
 395 lm, 2.700 K  
 <math>\sphericalangle 100^\circ</math>  
 230 V  
 $\varnothing 175 \times 50 \times 48$  mm  
 EAN 4000870 952702  
**952.70**



- White Metal/Plastic
- Blanco Metal/Plástico
- Bianco Metallo/Plastica

**Spot Circle**

incl. 1x5,3 W  
 408 lm, 2.700 K  
 <math>\sphericalangle 90^\circ</math>  
 230 V  
 $\varnothing 147 \times 98 \times 50$  mm  
 EAN 4000870 952719  
**952.71**



- Chrome matt Metal/Plastic
- Cromo mate Metal/Plástico
- Cromo opaco Metallo/Plastica

**Spot Circle**

incl. 1x5,3 W  
 408 lm, 2.700 K  
 <math>\sphericalangle 90^\circ</math>  
 230 V  
 $\varnothing 147 \times 98 \times 50$  mm  
 EAN 4000870 952726  
**952.72**



- White Metal/Plastic
- Blanco Metal/Plástico
- Bianco Metallo/Plastica

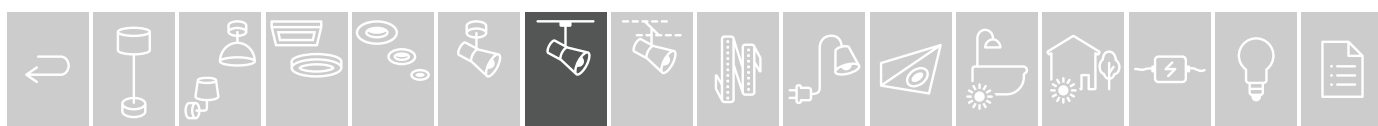



**Spot Tubo**  
 incl. 1x4,5 W  
 480 lm, 3.000 K  
 230 V  
 ⌀196 ⇄42 ⤴105 mm  
 EAN 4000870 955062  
**955.06**  
 ⚙ Chrome matt   Metal/Plastic  
 ⚙ Cromo mate   Metal/Plástico  
 ⚙ Cromo opaco   Metallo/  
 Plastica



**Spot Tubo**  
 incl. 1x4,5 W  
 480 lm, 3.000 K  
 230 V  
 ⌀196 ⇄42 ⤴105 mm  
 EAN 4000870 955079  
**955.07**  
 ⚙ White   Metal/Plastic  
 ⚙ Blanco   Metal/Plástico  
 ⚙ Bianco   Metallo/Plastica



**Spot Tubo**  
 incl. 1x4,5 W  
 480 lm, 3.000 K  
 230 V  
 ⌀186 ⇄42 ⤴105 mm  
 EAN 4000870 969175  
**969.17**  
 ⚙ Black matt   Metal/Plastic  
 ⚙ Negro mate   Metal/Plástico  
 ⚙ Nero opaco   Metallo/Plastica



**Spot Tubo**  
 incl. 1x4,5 W  
 540 lm, 4.000 K  
 230 V  
 ⌀186 ⇄42 ⤴105 mm  
 EAN 4000870 969403  
**969.40**  
 ⚙ Black matt/Chrome   Metal/  
 Plastic  
 ⚙ Negro mate/Cromo   Metal/  
 Plástico  
 ⚙ Nero opaco/Cromo   Metallo/  
 Plastica



**Spot Shine**  
 incl. 1x4,9 W  
 368 lm, 2.700 K  
 < 75°  
 230 V  
 ⌀180 ⇄59 ⤴90 mm  
 EAN 4000870 952733  
**952.73**  
 ⚙ Chrome matt   Metal/Plastic  
 ⚙ Cromo mate   Metal/Plástico  
 ⚙ Cromo opaco   Metallo/  
 Plastica



**Spot Shine**  
 incl. 1x4,9 W  
 368 lm, 2.700 K  
 < 75°  
 230 V  
 ⌀180 ⇄59 ⤴90 mm  
 EAN 4000870 952832  
**952.83**  
 ⚙ White   Metal/Plastic  
 ⚙ Blanco   Metal/Plástico  
 ⚙ Bianco   Metallo/Plastica



**Spot Hemi**  
 incl. 1x4,8 W  
 530 lm, 3.000 K  
 230 V  
 ⌀170 ⇄100 ⤴56 mm  
 EAN 4000870 955086  
**955.08**  
 ⚙ Chrome matt   Metal/Plastic  
 ⚙ Cromo mate   Metal/Plástico  
 ⚙ Cromo opaco   Metallo/  
 Plastica



**Spot Hemi**  
 incl. 1x4,8 W  
 500 lm, 3.000 K  
 230 V  
 ⌀170 ⇄100 ⤴56 mm  
 EAN 4000870 955093  
**955.09**  
 ⚙ White   Metal/Plastic  
 ⚙ Blanco   Metal/Plástico  
 ⚙ Bianco   Metallo/Plastica

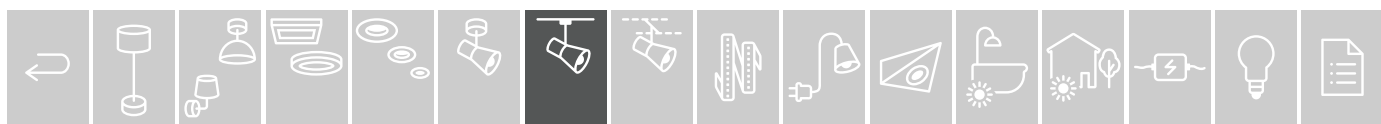

Spots without lamp  
Focos sin lámpara  
Spot senza lampadina



**Spot Tube**  
max. 10 W, GU10  
230 V  
↑128 ø65 mm  
EAN 4000870 969625  
**969.62**  
☞ Chrome matt/Chrome ☒ Metal/  
Plastic  
☞ Cromo mate/Cromo ☒ Metal/  
Plástico ☞ Cromo opaco/Cromo  
☒ Metallo/Plastica



**Spot Tube**  
max. 10 W, GU10  
230 V  
↑128 ø65 mm  
EAN 4000870 969632  
**969.63**  
☞ White/Chrome matt ☒ Metal/  
Plastic ☞ Blanco/Cromo mate  
☒ Metal/Plástico  
☞ Bianco/Cromo opaco  
☒ Metallo/Plastica



**Spot Tube**  
max. 10 W, GU10  
230 V  
↑128 ø65 mm  
EAN 4000870 969182  
**969.18**  
☞ Black matt/Chrome ☒ Metal/  
Plastic ☞ Negro mate/Cromo  
☒ Metal/Plástico  
☞ Nero opaco/Cromo ☒ Metallo/  
Plastica

**Spot Pipe**  
max. 10 W, GU10  
230 V  
↑150 ø65 ↗100 mm  
EAN 4000870 976128  
**976.12**  
☞ Chrome matt/Chrome ☒ Metal/  
Plastic ☞ Cromo mate/Cromo  
☒ Metal/Plástico  
☞ Cromo opaco/Cromo  
☒ Metallo/Plastica

**Spot Pipe**  
max. 10 W, GU10  
230 V  
↑150 ø65 ↗100 mm  
EAN 4000870 953631  
**953.63**  
☞ White/Chrome ☒ Metal/Plastic  
☞ Blanco/Cromo ☒ Metal/  
Plástico ☞ Bianco/Cromo  
☒ Metallo/Plastica



**Spot Cone**  
max. 10 W, GU10  
230 V  
↑180 ø85 ↗90 mm  
EAN 4000870 976135  
**976.13**  
☞ Chrome matt/Chrome ☒ Metal/  
Plastic  
☞ Cromo mate/Cromo ☒ Metal/  
Plástico  
☞ Cromo opaco/Cromo  
☒ Metallo/Plastica



**Spot Cone**  
max. 10 W, GU10  
230 V  
↑180 ø85 ↗90 mm  
EAN 4000870 953624  
**953.62**  
☞ White/Chrome ☒ Metal/Plastic  
☞ Blanco/Cromo ☒ Metal/  
Plástico  
☞ Bianco/Cromo ☒ Metallo/  
Plastica



**Spot Cone**  
max. 10 W, GU10  
230 V  
↑180 ø85 ↗90 mm  
EAN 4000870 969250  
**969.25**  
☞ Black matt/Chrome ☒ Metal/  
Plastic  
☞ Negro mate/Cromo ☒ Metal/  
Plástico  
☞ Nero opaco/Cromo ☒ Metallo/  
Plastica

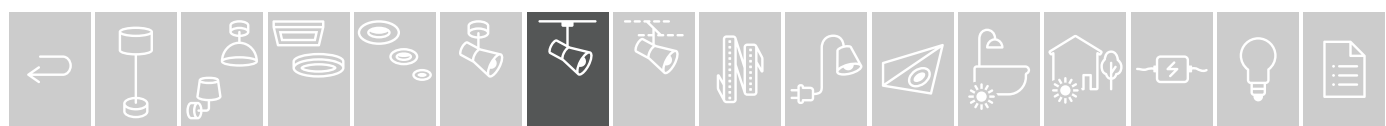

Spots with lamps  
 Focos con lámparas  
 Spot con lampadina

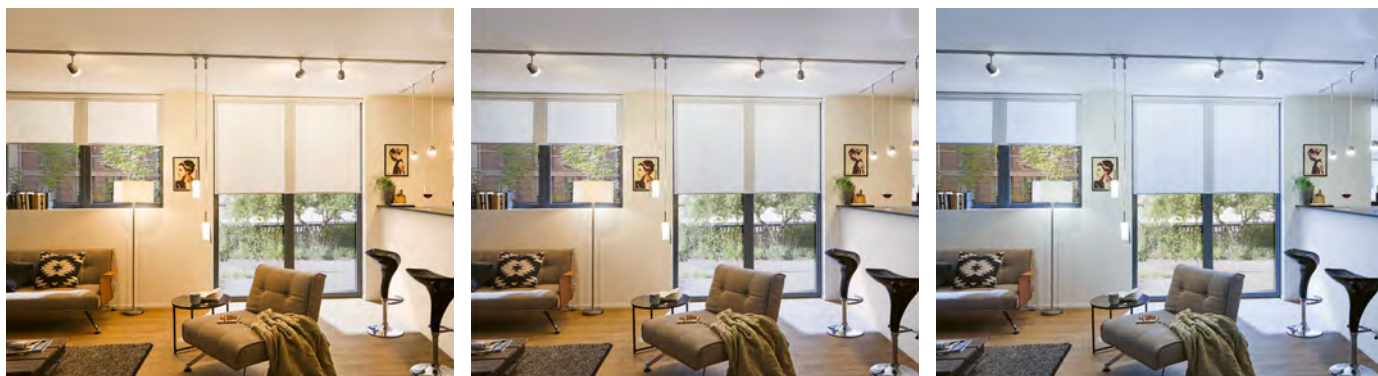

**Spot Cone**

incl. 1x5 W, GU10  
 330 lm, 2.700 - 6.500 K  
 <math>\sphericalangle</math> 36°  
 230 V  
 <math>\varnothing</math>185 <math>\varnothing</math>85 <math>\varnothing</math>90 mm  
 EAN 4000870 955260



- & Chrome matt/Chrome Metal
- & Cromo mate/Cromo Metal
- & Cromo opaco/Cromo Metallo



**Spot Cone**

incl. 1x5,5 W, GU10  
 350 lm, 2.700 - 6.500 K  
 <math>\sphericalangle</math> 36°  
 230 V  
 <math>\varnothing</math>180 <math>\varnothing</math>85 <math>\varnothing</math>90 mm  
 EAN 4000870 955253



- & Chrome matt Metal/Plastic
- & Cromo mate Metal/Plástico
- & Cromo opaco Metallo/Plastica

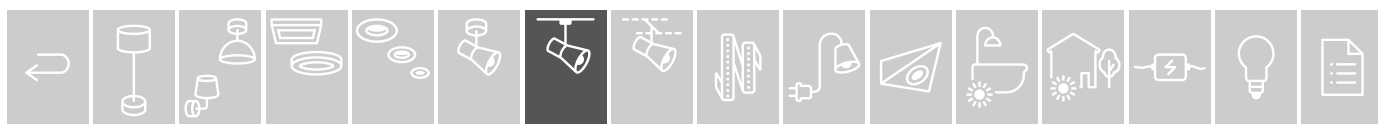

*Spots without lamp*  
*Focos sin lámpara*  
*Spot senza lampadina*



**Spot Pure I**  
 max. 10W, GU10  
 230V  
 ⌀110 ⇄58 ⚓66 mm  
 EAN 4000870 953297  
**953.29**  
 ⚡ Chrome matt/Chrome ⌘ Metal/  
 Plastic  
 ⚡ Cromo mate/Cromo ⌘ Metal/  
 Plástico  
 ⚡ Cromo opaco/Cromo  
 ⌘ Metallo/Plastica



**Spot Pure I**  
 max. 10W, GU10  
 230V  
 ⌀110 ⇄58 ⚓66 mm  
 EAN 4000870 953303  
**953.30**  
 ⚡ White/Chrome ⌘ Metal/Plastic  
 ⚡ Blanco/Cromo ⌘ Metal/  
 Plástico  
 ⚡ Bianco/Cromo ⌘ Metallo/  
 Plastica



**Starter Set Pure II**  
 max. 3×10W, GU10  
 230V  
 ⇄1,2 m  
 EAN 4000870 954638  
**954.63**  
 ⚡ Chrome matt/Chrome ⌘ Metal/  
 Plastic  
 ⚡ Cromo mate/Cromo ⌘ Metal/  
 Plástico  
 ⚡ Cromo opaco/Cromo  
 ⌘ Metallo/Plastica



**Spot Pure II**  
 max. 10W, GU10  
 230V  
 ⌀110 ⇄58 ⚓66 mm  
 EAN 4000870 953310  
**953.31**  
 ⚡ Chrome matt/Chrome ⌘ Metal/  
 Plastic  
 ⚡ Cromo mate/Cromo ⌘ Metal/  
 Plástico  
 ⚡ Cromo opaco/Cromo  
 ⌘ Metallo/Plastica

**Spot Pure II**  
 max. 10W, GU10  
 230V  
 ⌀110 ⇄58 ⚓66 mm  
 EAN 4000870 953334  
**953.33**  
 ⚡ White/Chrome ⌘ Metal/Plastic  
 ⚡ Blanco/Cromo ⌘ Metal/  
 Plástico  
 ⚡ Bianco/Cromo ⌘ Metallo/  
 Plastica

**Spot Pure II**  
 max. 10W, GU10  
 230V  
 ⌀151 ⇄58 ⚓66 mm  
 EAN 4000870 969113  
**969.11**  
 ⚡ Black matt ⌘ Metal/Plastic  
 ⚡ Negro mate ⌘ Metal/Plástico  
 ⚡ Nero opaco ⌘ Metallo/Plastica

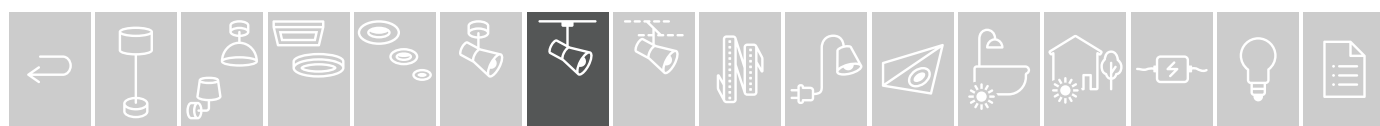



**Starter Set Barelli**

max. 3x10W, GU10  
230V  
↔1,2m  
EAN 4000870 954591

**954.59**

- ☞ Chrome matt/Chrome ☒ Metal/Plastic
- ☞ Cromo mate/Cromo ☒ Metal/Plástico
- ☞ Cromo opaco/Cromo ☒ Metallo/Plastica



**Spot Barelli**

max. 10W, GU10  
230V  
⤴138 ⤵68 ⤶35mm  
EAN 4000870 954614

**954.61**

- ☞ Chrome matt/Chrome ☒ Metal/Plastic
- ☞ Cromo mate/Cromo ☒ Metal/Plástico
- ☞ Cromo opaco/Cromo ☒ Metallo/Plastica

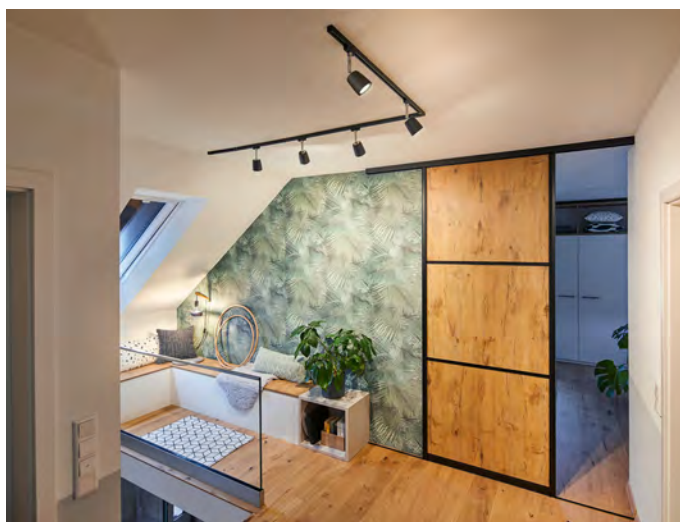
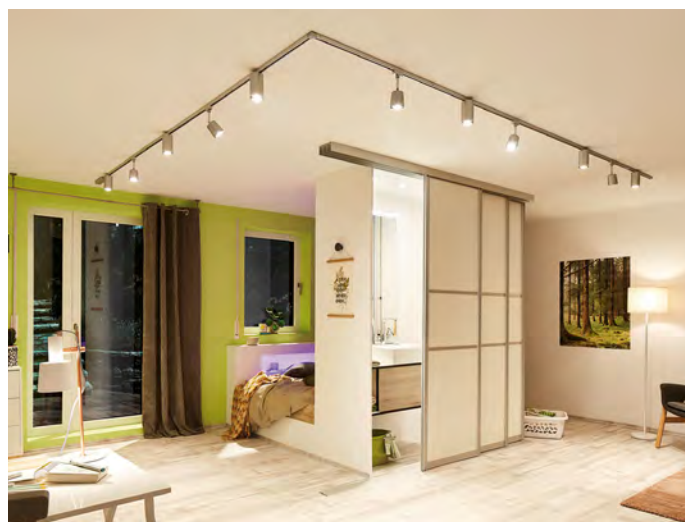

**Starter Set Cover**

max. 3x10W, GU10  
230V  
↔1,2m  
EAN 4000870 954621

**954.62**

- ☞ Chrome matt/Chrome ☒ Metal/Plastic
- ☞ Cromo mate/Cromo ☒ Metal/Plástico
- ☞ Cromo opaco/Cromo ☒ Metallo/Plastica



**Spot Cover**

max. 10W, GU10  
230V  
⤴140 ⤵58 ⤶90mm  
EAN 4000870 953358

**953.35**

- ☞ Chrome matt/Chrome ☒ Metal/Plastic
- ☞ Cromo mate/Cromo ☒ Metal/Plástico
- ☞ Cromo opaco/Cromo ☒ Metallo/Plastica



**Spot Cover**

max. 10W, GU10  
230V  
⤴140 ⤵58 ⤶90mm  
EAN 4000870 953365

**953.36**

- ☞ White/Chrome ☒ Metal/Plastic
- ☞ Blanco/Cromo ☒ Metal/Plástico
- ☞ Bianco/Cromo ☒ Metallo/Plastica



**Spot Cover**

max. 10W, GU10  
230V  
⤴140 ⤵58 ⤶90mm  
EAN 4000870 969267

**969.26**

- ☞ Black matt/Chrome ☒ Metal/Plastic
- ☞ Negro mate/Cromo ☒ Metal/Plástico
- ☞ Nero opaco/Cromo ☒ Metallo/Plastica

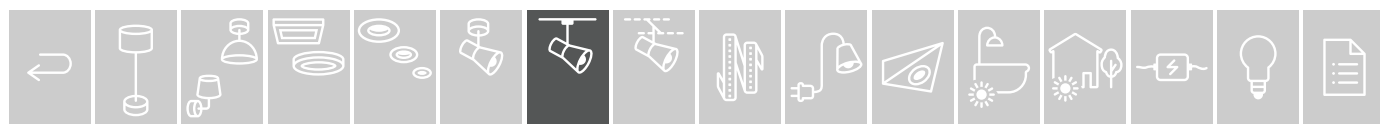



**Spot Blossom**

max. 10 W, G9  
230 V

⌀128 ⇄74 ↗115 mm  
EAN 4000870 953372

**953.37**

- ⌘ Chrome matt/Satin ☒ Metal/  
Glass
- ⌘ Cromo mate/Satinado
- ☒ Metal/Cristal
- ⌘ Cromo opaco/Satinato
- ☒ Metallo/Vetro



**Spot Blossom**

max. 10 W, G9  
230 V

⌀128 ⇄74 ↗115 mm  
EAN 4000870 953426

**953.42**

- ⌘ White/Satin ☒ Metal/Glass
- ⌘ Blanco/Satinado ☒ Metal/  
Cristal
- ⌘ Bianco/Satinato ☒ Metallo/  
Vetro



**Spot Blossom**

max. 10 W, G9  
230 V

⌀128 ø65 mm  
EAN 4000870 969663

**969.66**

- ⌘ Black matt/Satin ☒ Metal/  
Glass
- ⌘ Negro mate/Satinado ☒ Metal/  
Cristal
- ⌘ Nero opaco/Satinato
- ☒ Metallo/Vetro

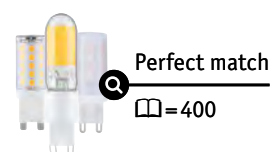

**Spot Blossom**

max. 10 W, G9  
230 V

⌀128 ⇄74 ↗115 mm  
EAN 4000870 953396

**953.39**

- ⌘ Chrome matt/Smoke glass
- ☒ Metal/Glass
- ⌘ Cromo mate/Vidrio ahumado
- ☒ Metal/Cristal
- ⌘ Cromo opaco/Vetro opaco
- ☒ Metallo/Vetro



**Spot Blossom**

max. 10 W, G9  
230 V

⌀128 ⇄74 ↗115 mm  
EAN 4000870 953440

**953.44**

- ⌘ White/Transparent grey
- ☒ Metal/Glass
- ⌘ Blanco/Gris transparente
- ☒ Metal/Cristal
- ⌘ Bianco/Grigio trasparente
- ☒ Metallo/Vetro



**Spot Blossom**

max. 10 W, G9  
230 V

⌀128 ø65 mm  
EAN 4000870 969670

**969.67**

- ⌘ Black matt/Smoke glass
- ☒ Metal/Glass
- ⌘ Negro mate/Vidrio ahumado
- ☒ Metal/Cristal
- ⌘ Nero opaco/Vetro opaco
- ☒ Metallo/Vetro



**Spot Blossom**

max. 10 W, G9  
230 V

⌀128 ⇄74 ↗115 mm  
EAN 4000870 953389

**953.38**

- ⌘ Chrome matt/Clear/Satin
- ☒ Metal/Glass ⌘ Cromo mate/  
Transparente/Satinado ☒ Metal/  
Cristal ⌘ Cromo opaco/Trasparente/  
Satinato ☒ Metallo/Vetro



**Spot Blossom**

max. 10 W, G9  
230 V

⌀128 ⇄74 ↗115 mm  
EAN 4000870 953433

**953.43**

- ⌘ White/Clear/Satin ☒ Metal/  
Glass ⌘ Blanco/Transparente/  
Satinado ☒ Metal/Cristal
- ⌘ Bianco/Trasparente/Satinato
- ☒ Metallo/Vetro

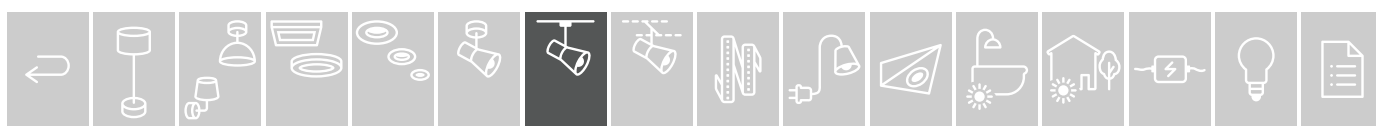

*Ceiling luminaires with non-replaceable LED*  
*Plafones con LED de instalación fija*  
*Plafoniere con LED fissi*



**Panel Loop**

incl. 1x7,64 W  
 1050 lm, 3.000 K  
 230 V  
 ⌀35 ⇄380 ↗110 mm  
 EAN 4000870 953198  
**953.19**



- 🌀 Chrome matt/Chrome 📦 Plastic
- 🌀 Cromo mate/Cromo 📦 Plástico
- 🌀 Cromo opaco/Cromo 📦 Plastica

**Panel Loop**

incl. 1x7,64 W  
 1050 lm, 2.700 K  
 230 V  
 ⌀35 ⇄380 ↗110 mm  
 EAN 4000870 953204  
**953.20**



- 🌀 White/Chrome 📦 Plastic
- 🌀 Blanco/Cromo 📦 Plástico
- 🌀 Bianco/Cromo 📦 Plastica

**Panel Loop**

incl. 1x7,64 W  
 1050 lm, 2.700 K  
 230 V  
 ⌀35 ⇄380 ↗110 mm  
 EAN 4000870 969205  
**969.20**



- 🌀 Black matt/Chrome 📦 Aluminium/Plastic
- 🌀 Negro mate/Cromo 📦 Aluminio/Plástico
- 🌀 Nero opaco/Cromo 📦 Alluminio/Plastica



**Safira**

incl. 1x4,9 W  
 440 lm, 2.700 K  
 230 V  
 ⌀136 ø80 ⇄80 mm  
 EAN 4000870 955017  
**955.01**



- 🌀 Chrome/Clear/Satin 📦 Metal/Acrylic
- 🌀 Cromo/Transparente/Satinado 📦 Metal/Acrílico
- 🌀 Cromo/Trasparente/Satinato 📦 Metallo/Acricilo



**Topa**

incl. 1x4,9 W  
 400 lm, 2.700 K  
 230 V  
 ⌀73 ø80 ⇄80 mm  
 EAN 4000870 955024  
**955.02**



- 🌀 Chrome/Clear/Satin 📦 Metal/Acrylic
- 🌀 Cromo/Transparente/Satinado 📦 Metal/Acrílico
- 🌀 Cromo/Trasparente/Satinato 📦 Metallo/Acricilo

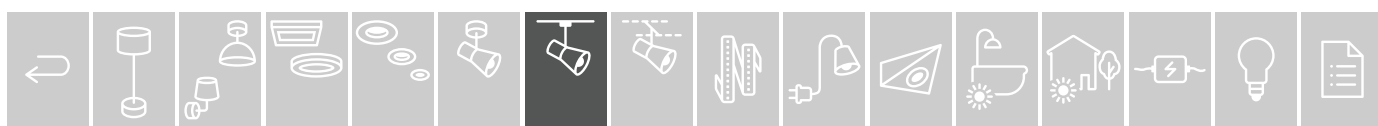



Ceiling luminaires without lamp  
 Plafones sin lámpara  
 Plafoniere senza lampadina



Perfect match

☐=412-432



Perfect match

☐=430-431



**Ceiling Socket**

max. 20 W, E27

230 V

⤴96 ø55 mm

EAN 4000870 949733

**949.73**

- ☞ Chrome matt ☐ Metal
- ☞ Cromo mate ☐ Metal
- ☞ Cromo opaco ☐ Metallo



**Ceiling Socket**

max. 20 W, E27

230 V

⤴96 ø55 mm

EAN 4000870 949740

**949.74**

- ☞ White ☐ Metal
- ☞ Blanco ☐ Metal
- ☞ Bianco ☐ Metallo



**Ceiling Socket**

max. 20 W, E27

230 V

⤴96 ø55 mm

EAN 4000870 949757

**949.75**

- ☞ Black ☐ Metal
- ☞ Negro ☐ Metal
- ☞ Nero ☐ Metallo



**Ceiling Globe Small**

max. 10 W, E14

230 V

⤴320 ø200 mm

EAN 4000870 976029

**976.02**

- ☞ Chrome matt/Opal ☐ Metal/  
Glass
- ☞ Cromo mate/Opal ☐ Metal/  
Cristal
- ☞ Cromo opaco/Opale ☐ Metallo/  
Vetro

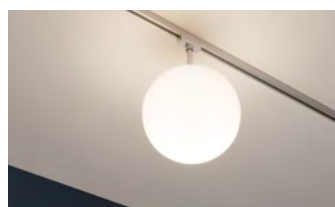





**LED Pendulum Barrel**

incl. 1x6,6 W  
626 lm, 2.700 K  
∠ 106°, 139 cd  
230 V  
↑135 cm ø85 mm  
EAN 4000870 951774  
**951.77**



☞ Chrome matt/Anodised aluminium ☒ Metal/Plastic  
☞ Cromo mate/Aluminio anodizado ☒ Metal/Plástico ☞ Cromo opaco/Alluminio anodizzato ☒ Metallo/Plastica



**Pendulum Capsule II**

incl. 1x6,3 W  
445 lm, 2.700 K  
230 V  
↑130 cm ø87 mm  
EAN 4000870 954577  
**954.57**



☞ Chrome matt/Chrome ☒ Metal/Plastic  
☞ Cromo mate/Cromo ☒ Metal/Plástico  
☞ Cromo opaco/Cromo ☒ Metallo/Plastica

**Pendulum Capsule II**

incl. 1x6,3 W  
445 lm, 2.700 K  
230 V  
↑130 cm ø87 mm  
EAN 4000870 954584  
**954.58**



☞ White/Chrome ☒ Metal/Plastic  
☞ Blanco/Cromo ☒ Metal/Plástico  
☞ Bianco/Cromo ☒ Metallo/Plastica

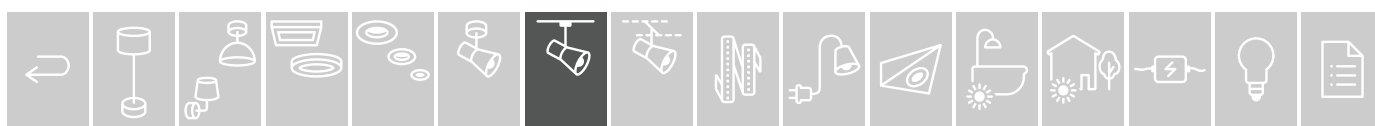

*Pendulum luminaires without lamps*  
*Luminarias colgantes sin lámpara*  
*Lampade a sospensione senza lampadina*



**Pendulum Arido II**

incl. 1x5 W, GU10  
 560 lm, 2.700 K  
 230 V  
 ⚡200 mm ⚡158 cm ø110 mm  
 EAN 4000870 949986

**949.98**

- ⌘ Chrome matt/Clear/Satin
- ⌘ Glass/Metal
- ⌘ Cromo mate/Transparente/Satinado
- ⌘ Cromo opaco/Trasparente/Satinato
- ⌘ Cromo opaco/Trasparente/Satinato
- ⌘ Vetro/Metallo

**Pendulum Catalejo**

max. 10W, GU10  
 230 V  
 ⚡383 mm ⚡160 cm ø65 mm  
 EAN 4000870 969588

**969.58**

- ⌘ Chrome matt
- ⌘ Cromo mate
- ⌘ Cromo opaco
- ⌘ Metal
- ⌘ Metal
- ⌘ Metallo



Perfect match

☐ = 401-402



**Pendulum Sarrasani**

max. 20 W, E14  
 230 V  
 ⚡140 cm  
 EAN 4000870 969755

**969.75**

- ⌘ Chrome matt/Dichroic
- ⌘ Cromo mate/Dicroico
- ⌘ Cromo opaco/Dicroico
- ⌘ Metal/Glass
- ⌘ Metal/Cristal
- ⌘ Metallo/Vetro

**Pendulum Sarrasani**

max. 20 W, E14  
 230 V  
 ⚡140 cm  
 EAN 4000870 969762

**969.76**

- ⌘ Black matt/Dichroic
- ⌘ Negro mate/Dicroico
- ⌘ Nero opaco/Dicroico
- ⌘ Metal/Glass
- ⌘ Metal/Cristal
- ⌘ Metallo/Vetro



Perfect match

☐ = 407-408  
 416

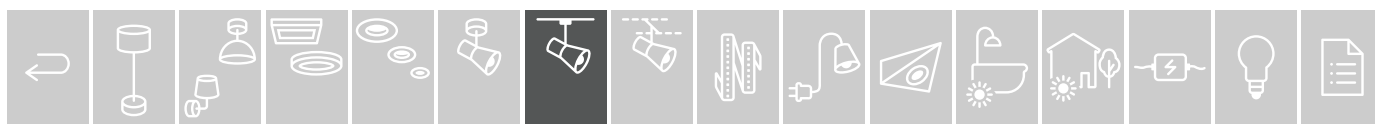



**Pendulum Sarrasani**

max. 20 W, E14  
230 V  
140 cm  
EAN 4000870 969724  
**969.72**

- ☞ Chrome matt/Opal ☒ Metal/Glass
- ☞ Cromo mate/Opal ☒ Metal/Cristal
- ☞ Cromo opaco/Opale ☒ Metallo/Vetro



**Pendulum Sarrasani**

max. 20 W, E14  
230 V  
140 cm  
EAN 4000870 969731  
**969.73**

- ☞ White/Opal ☒ Metal/Glass
- ☞ Blanco/Opal ☒ Metal/Cristal
- ☞ Bianco/Opale ☒ Metallo/Vetro



**Pendulum Sarrasani**

max. 20 W, E14  
230 V  
140 cm  
EAN 4000870 969748  
**969.74**

- ☞ Black matt/Opal ☒ Metal/Glass
- ☞ Negro mate/Opal ☒ Metal/Cristal
- ☞ Nero opaco/Opale ☒ Metallo/Vetro

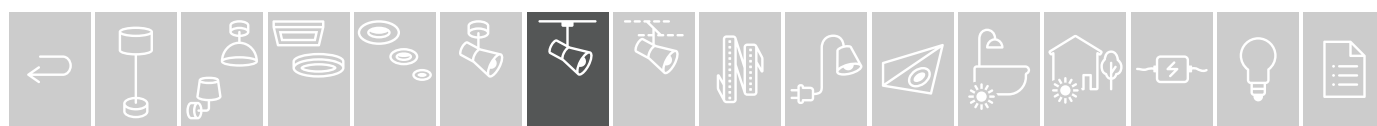

Combine your own personal lighting system  
 Combine usted mismo su sistema de luz personal  
 Scegliete voi stessi le combinazioni per il vostro sistema  
 d'illuminazione personalizzato

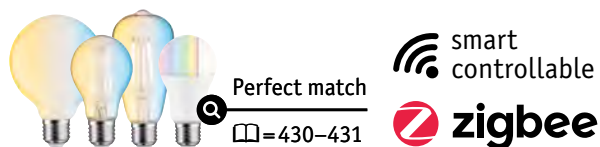
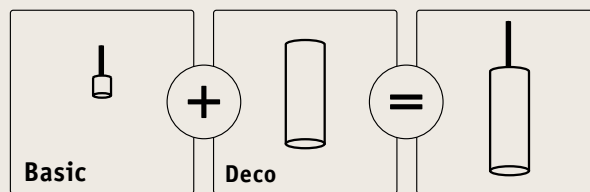

**Pendulum Alari**  
 max. 20 W, E27  
 230 V  
 ⚙️ 150 cm  
 EAN 4000870 954362  
**954.36**

- 🔩 Chrome matt/Chrome
- 📏 Metal/Plastic
- 🔩 Cromo mate/Cromo
- 📏 Metal/Plástico
- 🔩 Cromo opaco/Cromo
- 📏 Metallo/Plastica



**Pendulum Alari**  
 max. 20 W, E27  
 230 V  
 ⚙️ 150 cm  
 EAN 4000870 954379  
**954.37**

- 🔩 White/Chrome
- 📏 Metal/Plastic
- 🔩 Blanco/Cromo
- 📏 Metal/Plástico
- 🔩 Bianco/Cromo
- 📏 Metallo/Plastica

**Pendulum Alari**  
 max. 20 W, E27  
 230 V  
 ⚙️ 150 cm  
 EAN 4000870 969199  
**969.19**

- 🔩 Black matt/Chrome
- 📏 Metal/Plastic
- 🔩 Negro mate/Cromo
- 📏 Metal/Plástico
- 🔩 Nero opaco/Cromo
- 📏 Metallo/Plastica

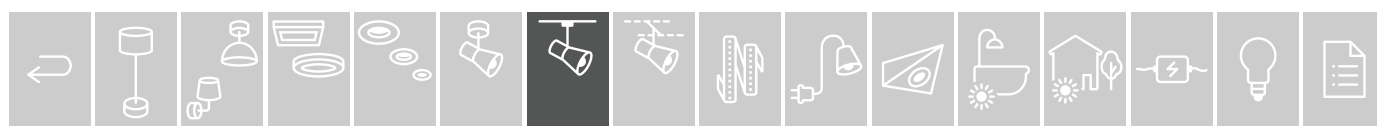



**2Easy Alari**

max. 20 W  
 ø300 mm  
 EAN 4000870 954447  
**954.44**

- Opal Glass
- Opal Cristal
- Opale Vetro



**2Easy Alari**

max. 20 W  
 ø300 mm  
 EAN 4000870 954454  
**954.45**

- Satin/Clear Glass
- Satinado/Cristal
- Satinado/Transparente Cristal
- Satinato/Trasparente Vetro



**Shade Pirm**

max. 20 W  
 230 ø280 mm  
 EAN 4000870 954409  
**954.40**

- Grey matt Metal
- Gris mate Metal
- Grigio opaco Metallo



**Shade Pien**

max. 20 W  
 230 ø250 mm  
 EAN 4000870 954423  
**954.42**

- Beige matt Metal
- Beige mate Metal
- Beige opaco Metallo



**Shade Pom**

max. 20 W  
 240 ø350 mm  
 EAN 4000870 954386  
**954.38**

- Matt white Metal
- Blanco mate Metal
- Bianco opaco Metallo



**Vento**

280 ø170 mm  
 EAN 4000870 953518  
**953.51**

- Clear Glass
- Transparente Cristal
- Trasparente Vetro



**Drio**

280 ø152 mm  
 EAN 4000870 953525  
**953.52**

- Smoke glass Glass
- Vidrio ahumado Cristal
- Vetro opaco Vetro



**Vento**

280 ø170 mm  
 EAN 4000870 953549  
**953.54**

- Opal Glass
- Opal Cristal
- Opale Vetro



**Livo**

280 ø75 mm  
 EAN 4000870 998427  
**998.42**

- Opal Glass
- Opal Cristal
- Opale Vetro



**Tessa**

max. 50 W  
 260 ø454 mm  
 EAN 4000870 954652  
**954.65**

- Light grey Fabric
- Gris claro Tela
- Grigio chiaro Tessuto



**Tessa**

max. 50 W  
 260 ø454 mm  
 EAN 4000870 954669  
**954.66**

- Cream Fabric
- Crema Tela
- Crema Tessuto



**2Easy Diffusor**

max. 20 W  
 ø454 mm  
 EAN 4000870 954928  
**954.92**

- Satin Plastic
- Satinado Plástico
- Satinato Plastica

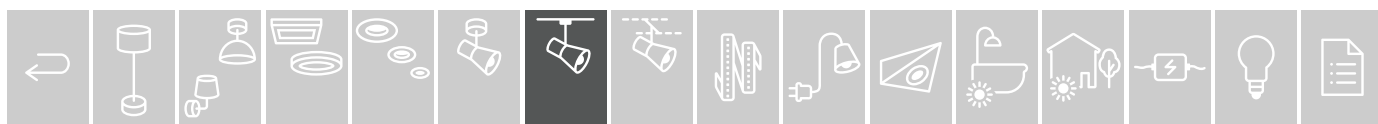



**LED End Cap**

incl. 1x5,3W  
440 lm, 2.700 K  
∠ 80°  
230 V  
∅27 ⇄141 ∅57 mm  
EAN 4000870 954799



**954.79**

- Chrome matt Metal
- Cromo mate Metal
- Cromo opaco Metallo



**LED End Cap**

incl. 1x5,3W  
440 lm, 2.700 K  
∠ 80°  
230 V  
∅27 ⇄141 ∅57 mm  
EAN 4000870 954805



**954.80**

- White Metal
- Blanco Metal
- Bianco Metallo



**LED Line Connector**

incl. 1x5,3W  
440 lm, 2.700 K  
∠ 80°  
230 V  
∅27 ⇄189 ∅57 mm  
EAN 4000870 954775



**954.77**

- Chrome matt Metal
- Cromo mate Metal
- Cromo opaco Metallo



**LED Line Connector**

incl. 1x5,3W  
440 lm, 2.700 K  
∠ 80°  
230 V  
∅27 ⇄189 ∅57 mm  
EAN 4000870 954782



**954.78**

- White Metal
- Blanco Metal
- Bianco Metallo

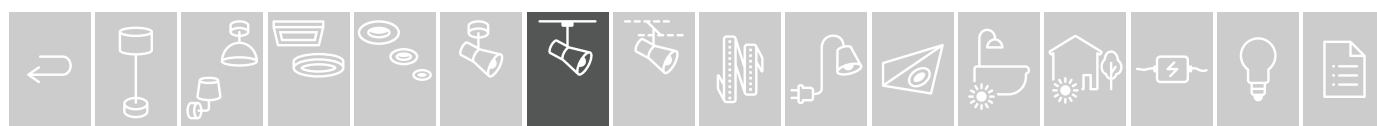





**LED L-Connector**

incl. 1x5,3 W  
440 lm, 2.700 K  
∠ 80°  
230 V  
∅27 ⇄141 ⇄141 mm  
EAN 4000870 954850

**954.85**

- Chrome matt Metal
- Cromo mate Metal
- Cromo opaco Metallo



**LED L-Connector**

incl. 1x5,3 W  
440 lm, 2.700 K  
∠ 80°  
230 V  
∅27 ⇄141 ⇄141 mm  
EAN 4000870 954867

**954.86**

- White Metal
- Blanco Metal
- Bianco Metallo



**LED T-Connector**

incl. 1x5,3 W  
440 lm, 2.700 K  
∠ 80°  
230 V  
∅27 ⇄224 ⇄141 mm  
EAN 4000870 954836

**954.83**

- Chrome matt Metal
- Cromo mate Metal
- Cromo opaco Metallo



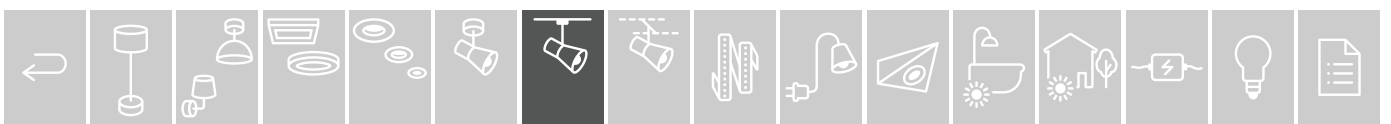
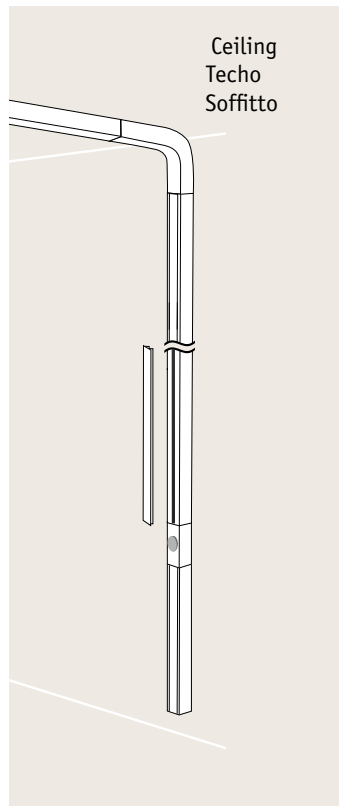
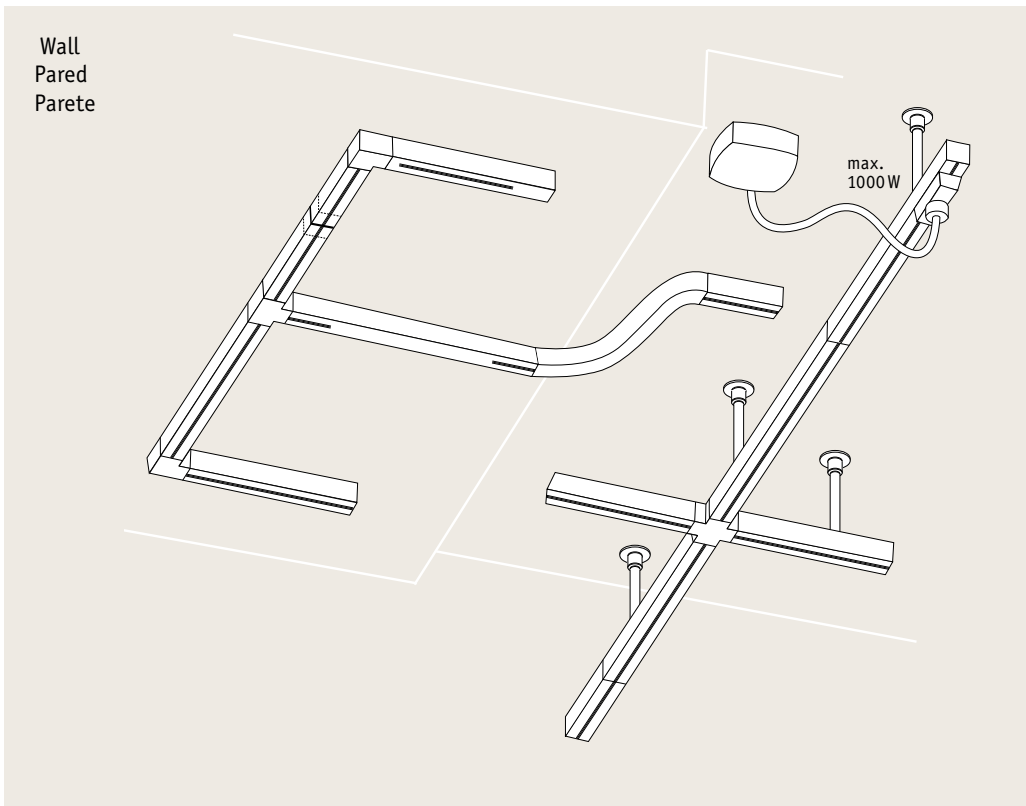



**CM** Chrome matt  
Cromo mate  
Cromo opaco



**W** White  
Blanco  
Bianco



**B** Black  
Negro  
Nero



**Single Spot Base**

max. 50 W  
↕35,5 ø100 mm

**CM** EAN 4000870 968208  
**968.20 new**

**W** EAN 4000870 968215  
**968.21 new**

**B** EAN 4000870 968222  
**968.22 new**

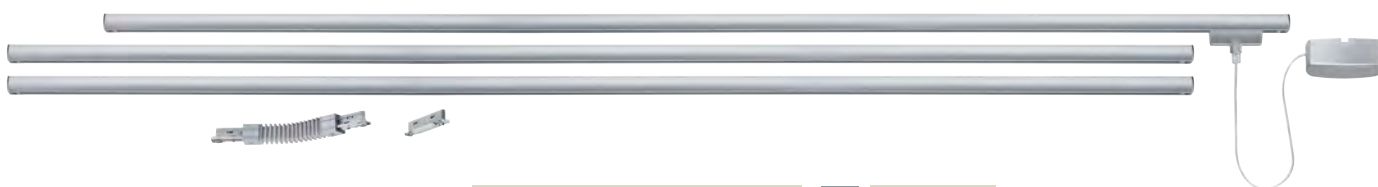

**URail Basicsystem**  
Sistema de base URail  
Sistema base URail

max. 1,000 W

**CM** ↔3,1 m  
EAN 4000870 950166  
**950.16**

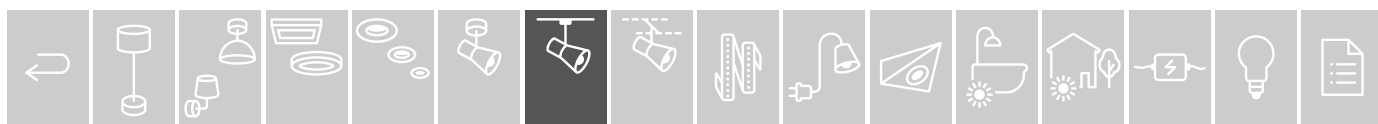

**Track  
Riel  
Binari**

max. 1,000 W  
 $\updownarrow$ 18 mm  $\curvearrowright$ 18 mm



**CM**  $\leftrightarrow$ 0,1 m  
 EAN 4000870 950869  
**950.86**

**W**  $\leftrightarrow$ 0,1 m  
 EAN 4000870 954980  
**954.98**

**B**  $\leftrightarrow$ 0,1 m  
 EAN 4000870 969021  
**969.02**

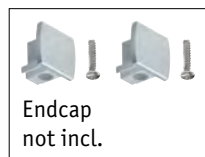

**CM**  $\leftrightarrow$ 0,5 m  
 EAN 4000870 968543  
**968.54**

**W**  $\leftrightarrow$ 0,5 m  
 EAN 4000870 976821  
**976.82**

**B**  $\leftrightarrow$ 0,5 m  
 EAN 4000870 969038  
**969.03**



**CM**  $\leftrightarrow$ 1 m  
 EAN 4000870 968338  
**968.33**

**W**  $\leftrightarrow$ 1 m  
 EAN 4000870 976838  
**976.83**

**B**  $\leftrightarrow$ 1 m  
 EAN 4000870 969045  
**969.04**



**CM**  $\leftrightarrow$ 2 m  
 EAN 4000870 968345  
**968.34**

**W**  $\leftrightarrow$ 2 m  
 EAN 4000870 976845  
**976.84**

**B**  $\leftrightarrow$ 2 m  
 EAN 4000870 969052  
**969.05**



**Urail Safety Cover Strip**  
 $\curvearrowright$ 10 mm  $\leftrightarrow$ 68 cm

**W**  
 EAN 4000870 951262  
**951.26**

**B**  
 EAN 4000870 954157  
**954.15 new**



**Universal Endcap 2-Pack**  
 $\updownarrow$ 18  $\leftrightarrow$ 13  $\curvearrowright$ 21 mm

**CM**  
 EAN 4000870 954966  
**954.96**

**W**  
 EAN 4000870 954973  
**954.97**

**B**  
 EAN 4000870 969618  
**969.61**



**Suspension  
Suspensión  
Sospensione**  
 $\updownarrow$ 105  $\varnothing$ 23 mm

**CM**  
 EAN 4000870 975992  
**975.99**

**W**  
 EAN 4000870 976883  
**976.88**



**Suspension 125/250 mm**  
 $\updownarrow$ 125/250  $\leftrightarrow$ 18 mm

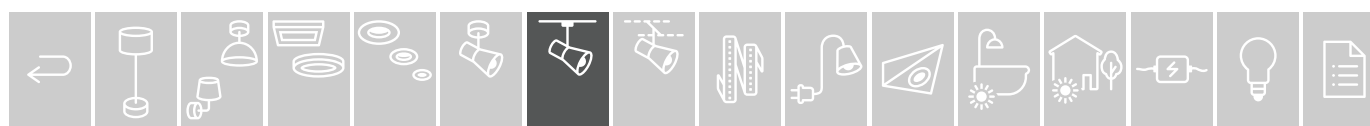
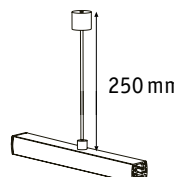
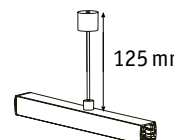

**W**  
 EAN 4000870 951491  
**951.49**





**Line Connector**

max. 1,000 W  
 ⌀15 ⇄70 ↗11 mm

 EAN 4000870 951361  
**951.36** 

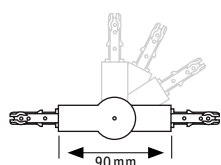

**Angle Connector**

max. 1,000 W  
 ⌀18 ⇄159 ↗36 mm

**CM** EAN 4000870 969649 **969.64** **W** EAN 4000870 969656 **969.65** **B** EAN 4000870 969090 **969.09** 



29 mm

**L-Connector**  
**L-Conector**  
**L-Connettore**

max. 1,000 W  
 ⌀18 ⇄62 ↗62 mm

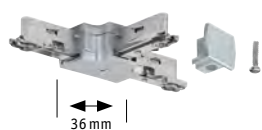

**CM** EAN 4000870 976487 **976.48** **W** EAN 4000870 976494 **976.49** **B** EAN 4000870 969069 **969.06** 



36 mm

**T-Connector**  
**T-Conector**  
**T-Connettore**

max. 1,000 W  
 ⌀18 ⇄104 ↗62 mm



**CM** EAN 4000870 976562 **976.56**  **W** EAN 4000870 976869 **976.86**  **B** EAN 4000870 969076 **969.07** 



36 mm

**X-Connector**  
**X-Conector**  
**X-Connettore**

max. 1,000 W  
 ⌀18 ⇄104 ↗104 mm

**CM** EAN 4000870 976579 **976.57**  **W** EAN 4000870 976876 **976.87**  **B** EAN 4000870 969083 **969.08** 

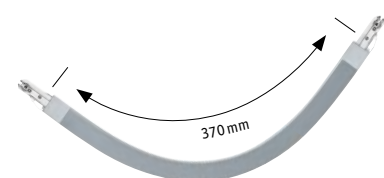

**Maxiflex Connector**  
**Conector Maxiflex**  
**Connettore Maxiflex**

max. 1,000 W  
 ⌀18 ⇄440 ↗18 mm

**CM** EAN 4000870 953273  
**953.27** 



**Flex Connector II**  
**Conector flexible II**  
**Connettore flessibile II**

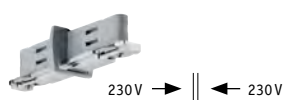

max. 1,000 W  
 ⌀18 ⇄227 ↗18 mm

**CM** EAN 4000870 953259 **953.25**  **W** EAN 4000870 953266 **953.26**  **B** EAN 4000870 969106 **969.10** 



**Power isolating link**  
**Divisor de corriente**  
**Sezionatore**

⌀18 ⇄70 ↗18 mm

 EAN 4000870 951408  
**951.40** 

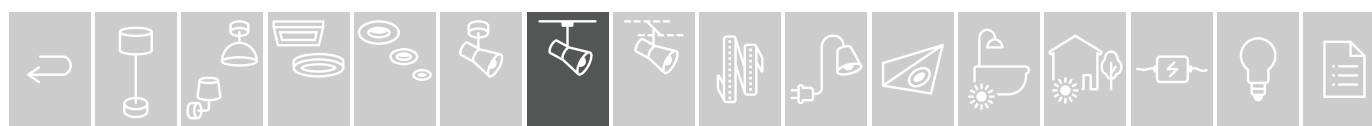





not incl.  
line connector

**Terminal feed**  
**Alimentación por un extremo**  
**Allimentazione finale**

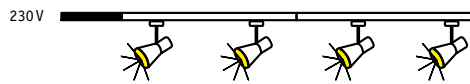
max. 1.000 W  
 ⚡18 ↔161 ↻18 mm



<b>CM</b>	<b>W</b>	<b>B</b>
EAN 4000870 976555 <b>976.55</b> 📦	EAN 4000870 976852 <b>976.85</b> 📦	EAN 4000870 969601 <b>969.60</b> 📦



not incl.  
line connector

**Middle/terminal feed**  
**Alimentación central / por un extremo**  
**Allimentazione centrale / finale**

max. 1.000 W  
 ⚡27 ↔205 ↻45 mm



<b>CM</b>	<b>W</b>
EAN 4000870 968857 <b>968.85</b> 📦	EAN 4000870 968864 <b>968.86</b> 📦

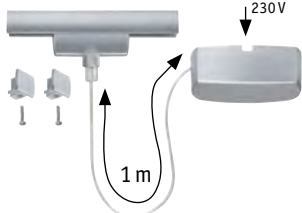

not incl.  
line connector

**Middle/terminal feed**  
**Alimentación central / por un extremo**  
**Allimentazione centrale / finale**

max. 1.000 W  
 ⚡30 mm ø75 mm ↔165 mm

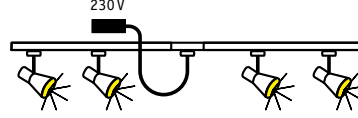

<b>CM</b>	<b>W</b>	<b>B</b>
EAN 4000870 968314 <b>968.31</b> 📦	EAN 4000870 976791 <b>976.79</b> 📦	EAN 4000870 969168 <b>969.16</b> 📦

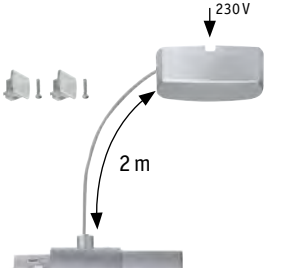

not incl.  
line connector

**Middle/terminal feed**  
**Alimentación central / por un extremo**  
**Allimentazione centrale / finale**

max. 1.000 W  
 ⚡30 mm ↔80 mm ↻80 mm ↔2 m

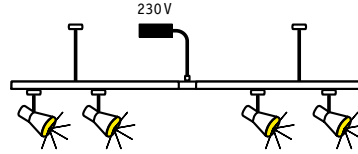

<b>CM</b>	<b>W</b>	<b>B</b>
EAN 4000870 954164 <b>954.16</b> <span style="color: red;">new</span>	EAN 4000870 954171 <b>954.17</b> <span style="color: red;">new</span>	EAN 4000870 954188 <b>954.18</b> <span style="color: red;">new</span>





- ▶ Middle feed with rails with separately switchable outputs
- ▶ For domestic electrical installations with 4/5-core wiring and series switch
- ▶ With cable bridge also suitable for 3-core wiring with toggle switch (then it cannot be switched separately)
- ▶ Alimentación central en forma de raíl con salidas conmutables por separado
- ▶ Para instalaciones domésticas con cableado de 4/5 conductores e interruptor de serie
- ▶ Con puente para cable, también es apto para el cableado de 3 conductores con conmutador (en este caso, no es posible la conmutación separada)
- ▶ Alimentazione centrale tramite binario con uscite commutabili separatamente
- ▶ Per installazioni domestiche con cablaggio a 4/5 fili e interruttori in serie
- ▶ Con canalina passacavi adatta anche per cablaggio a 3 fili con deviatore (in questo caso non commutabile separatamente)

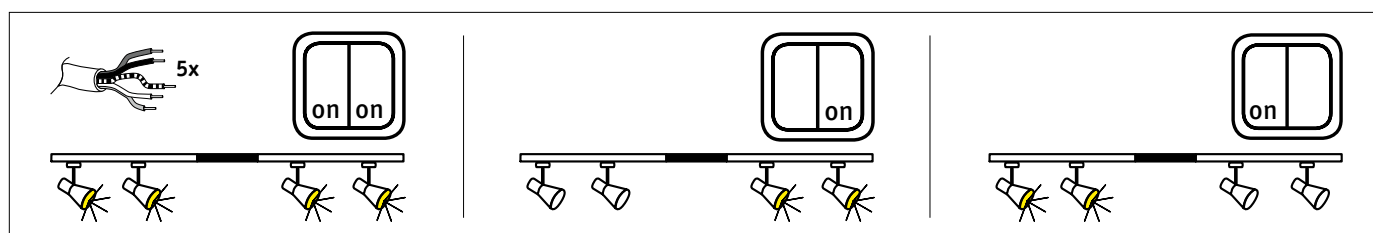
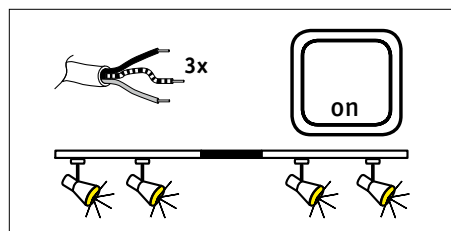

<b>URail Middle-Feed</b>	<b>CM</b>	<b>W</b>	<b>B</b>
max. 1,000/1,000 W ⌀18 ⇄304 ↗18 mm	EAN 4000870 977651 <b>977.65</b>	EAN 4000870 977668 <b>977.66</b>	EAN 4000870 969212 <b>969.21</b>

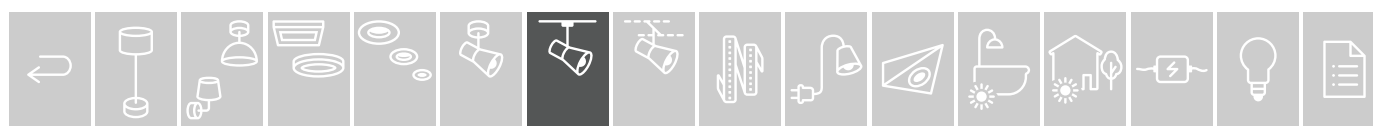



► For integrating Pendulums without a URail connection.

► Para incorporar péndulos sin conexión URail.

► Per integrare sospensioni senza attacco URail.

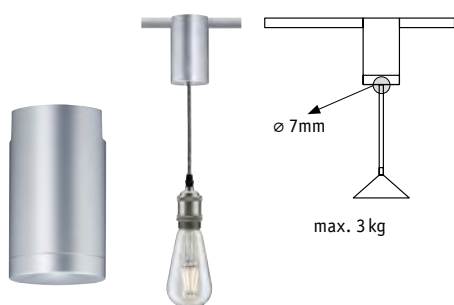

**Universal Pendant Adapter**

max. 100 W  
 ⚡106 ⌀62 mm

**CM**

EAN 4000870 954942  
**954.94**

**W**

EAN 4000870 954959  
**954.95**

**B**

EAN 4000870 955536  
**955.53 new**

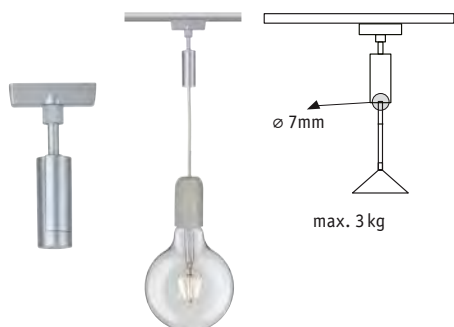

**Universal Pendant Adapter**

max. 50 W  
 ⚡124 ⌀23 ⇔57,5 mm

**CM**

EAN 4000870 955512  
**955.51 new**

**W**

EAN 4000870 955529  
**955.52 new**

**B**

EAN 4000870 969144  
**969.14**

- Pendulum adapter for shortening without cutting.
- The Pendulum cable is simply wound up in the adapter (max. 1m)

- Adaptador para péndulo para reducir la longitud sin cortar.
- El cable del péndulo se enrolla en el adaptador (máx. 1 m)

- Adattatore per sospensione da accorciare senza tagliare.
- Il cavo per sospensione viene avvolto nell'adattatore (max 1 m)

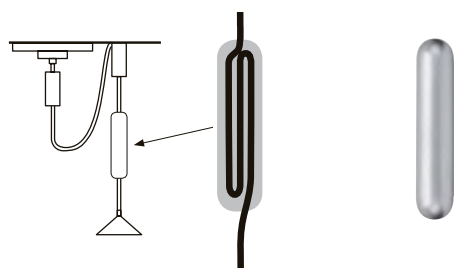

**Pendulum adapter, can be shortened  
 Adaptadores para péndulos, recortables  
 Adattatore accorciabile per lampadario**

⚡135 ⌀26 mm

**CM**



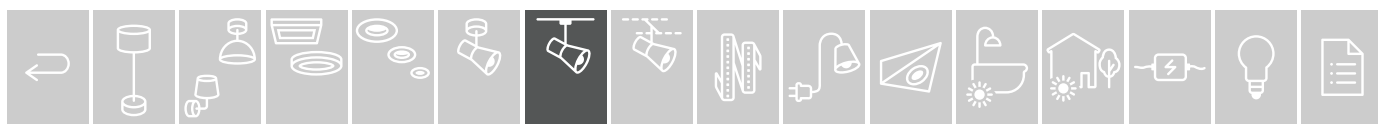

EAN 4000870 974742  
**974.74**

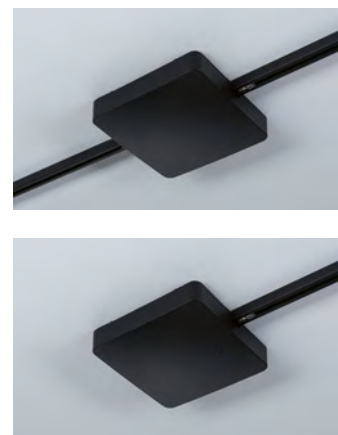







- ▶ Switches and dims downstream sections
- ▶ Can be used with the Paulmann ZigBee remote control or compatible systems below
- ▶ Conmuta y regula las secciones posteriores
- ▶ Utilizables con el mando a distancia ZigBee de Paulmann u otros sistemas compatibles
- ▶ Commutazione e dimming delle seguenti sezioni
- ▶ Utilizzabile con telecomando Zigbee Paulmann oppure con i sistemi compatibili indicati sotto

	<p><b>URail Dimm/Switch Adapter</b></p> <p>max. 400 W 230 V Ω max. 400 W, C max. 150 W, ⌀35 ⇄155 ⌀56 mm</p>		<p><b>CM</b></p> <p>EAN 4000870 500507 <b>500.50</b></p>	<p><b>W</b></p> <p>EAN 4000870 500514 <b>500.51</b></p>	<p><b>B</b></p> <p>EAN 4000870 968154 <b>968.15 new</b></p>
	<p><b>Middle/End feed</b></p> <p>max. 300 W ⌀48 ⇄227 ⌀196 mm</p>		<p><b>CM</b></p> <p>EAN 4000870 501207 <b>501.20 new</b></p>	<p><b>W</b></p> <p>EAN 4000870 501214 <b>501.21 new</b></p>	<p><b>B</b></p> <p>EAN 4000870 968192 <b>968.19 new</b></p>

- ▶ Allows single heads and group switching functions to be controlled to switch between different lighting scenarios (as with a 2-phase rail system)
- ▶ Can be used with the Paulmann ZigBee remote control or compatible systems below
- ▶ Permite controlar cabezales individuales y grupos interconectados, de manera que se pueden controlar diferentes escenarios de iluminación (como en un sistema de raíles de dos fases)
- ▶ Utilizables con el mando a distancia ZigBee de Paulmann u otros sistemas compatibles
- ▶ Consente il comando di singoli apparecchi e di gruppi, pertanto è possibile creare diversi scenari luminosi (come per il sistema a binario bi-fase)
- ▶ Utilizzabile con telecomando Zigbee Paulmann oppure con i sistemi compatibili indicati sotto

	<p><b>ZB Spot Adapter</b></p> <p>max. 50 W ⌀50 ⇄166 ⌀20 mm</p>		<p><b>CM</b></p> <p>EAN 4000870 968932 <b>968.93</b></p>
---	--	---	--

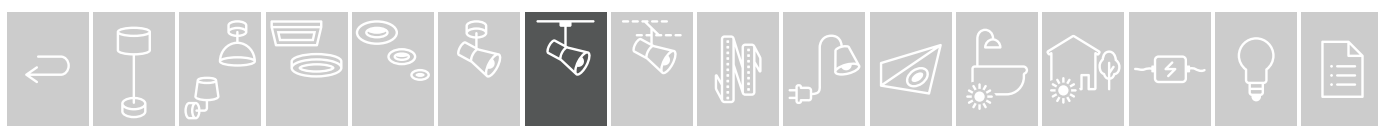

# Wire Systems CorDuo

186 LED 12V DC BLE

187 LED 12V DC

204 12V AC

208 DecoSystems

210 Accessories

192

## CorDuo: floating light on fine cables

The newly designed cable systems create elegant lighting in the most demanding room situations. Beams, stucco ceilings, slanted ceilings, attics, slopes and corners no longer pose a problem, and the light can be distributed throughout the room from just one power outlet. The complete sets can be easily expanded to include additional spots and come in the modern matt system colours chrome, white and black. All system components, including the modern design spots, cables, accessories and flat, lightweight transformers come in the same colours.

## CorDuo: luz flotante en cables de filigrana

Los sistemas de cables de nuevo diseño crean una iluminación elegante incluso en situaciones de espacio difíciles. Vigas, techos de estuco, techos inclinados o áticos, superficies inclinadas y esquinas se pueden superar sin problemas, distribuyendo la luz en toda la estancia con una única conexión eléctrica. Los juegos completos se pueden ampliar fácilmente con focos individuales y se presentan en los modernos colores de sistema mates cromo, blanco y negro. No solo los focos con su diseño moderno, también los mismos cables, accesorios y los transformadores planos y ligeros armonizan gracias a su color uniforme.

## CorDuo: luce oscillante su fili filigranati

I sistemi a filo di nuova concezione garantiscono un'illuminazione elegante anche in situazioni particolarmente problematiche. Che si tratti di travi, soffitti in stucco, tetti inclinati o mansarde, piani inclinati e angoli, questa soluzione risolve ogni problema permettendo di distribuire la luce con un solo allacciamento alla corrente in tutta la stanza. I set completi sono estensibili con la massima semplicità mediante singoli spot e sono disponibili nei colori di sistema moderni e opachi cromo, bianco e nero. Non solo gli spot dal design moderno, ma lo stesso filo, gli accessori e i trasformatori, con la loro leggerezza, risentono positivamente dell'effetto armonizzante di questa colorazione uniforme.

EN Suitable GU5.3 lamps in 3000 K or 4000 K are also available in the three system colours

ES Lámparas GU5,3 compatibles de 3000 K o 4000 K en los tres colores del sistema

IT Lampadine GU5,3 adatte 3000 K o 4000 K nei tre colori di sistema





☑ = 203



☑ = 196

-  Chrome matt
-  Cromo mate
-  Cromo opaco

-  White
-  Blanco
-  Bianco

-  Black
-  Negro
-  Nero



☑ = 191



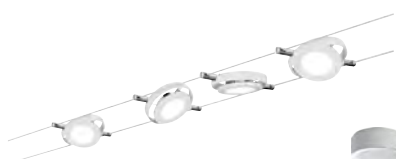
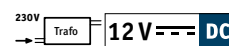

**BLE Set DiscLED I**

incl. 4x4 W  
 4x320 - 440 lm, 2.700 - 6.500 K  
 230/12 V, incl. ⚡ 36 VA  
 ⚡ 160 mm 2,5 mm<sup>2</sup> ↔ 10 m  
 EAN 4000870 501092  
**501.09**

- 🌀 Satin 🗍 Metal/Plastic
- 🌀 Satinado 🗍 Metal/Plástico
- 🌀 Satinato 🗍 Metallo/Plastica

**BLE Set RoundMac**

incl. 4x4 W  
 4x320 - 440 lm, 2.700 - 6.500 K  
 230/12 V, incl. ⚡ 36 VA  
 ⚡ 160 mm 2,5 mm<sup>2</sup> ↔ 10 m  
 EAN 4000870 501078  
**501.07**

- 🌀 Matt white 🗍 Metal/Plastic
- 🌀 Blanco mate 🗍 Metal/Plástico
- 🌀 Bianco opaco 🗍 Metallo/Plastica

**BLE Set IceLED**

incl. 4x4 W  
 4x320 - 440 lm, 2.700 - 6.500 K  
 230/12 V, incl. ⚡ 36 VA  
 ⚡ 160 mm 2,5 mm<sup>2</sup> ↔ 10 m  
 EAN 4000870 500163  
**500.16**

- 🌀 Chrome matt/White 🗍 Metal
- 🌀 Cromo mate/Blanco 🗍 Metal
- 🌀 Cromo opaco/Bianco 🗍 Metallo





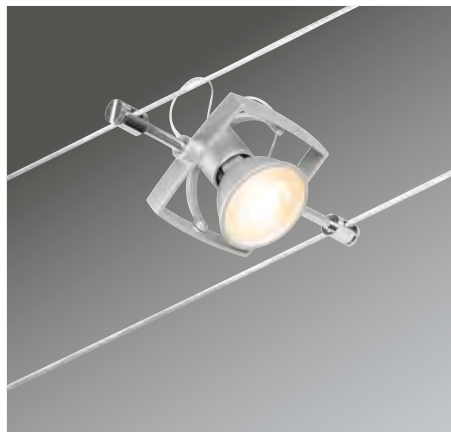

- 🌀 Chrome matt 🧺 Plastic
- 🌀 Cromo mate 🧺 Plástico
- 🌀 Cromo opaco 🧺 Plastica

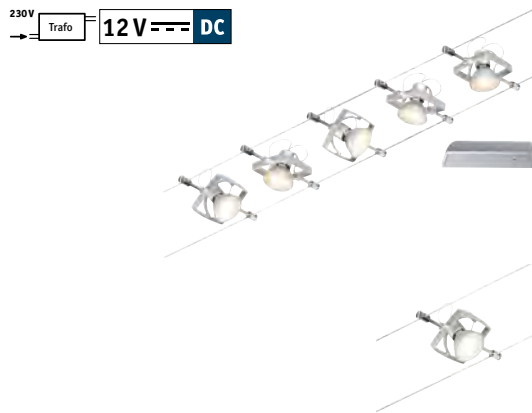

**Set Mac II**

max. 5×10W, GU5,3  
 230/12V, incl. ⚡ 60VA  
 ⚡ 160 mm 2,5 mm<sup>2</sup> ↔ 10 m  
 EAN 4000870 944301  
**944.30 new**

**Spot Mac II**

max. 10W, GU5,3  
 12V  
 ⚡ 160 mm  
 EAN 4000870 944318  
**944.31 new**



- 🌀 Matt white/Chrome 🧺 Plastic
- 🌀 Blanco mate/Cromo 🧺 Plástico
- 🌀 Bianco opaco/Cromo 🧺 Plastica

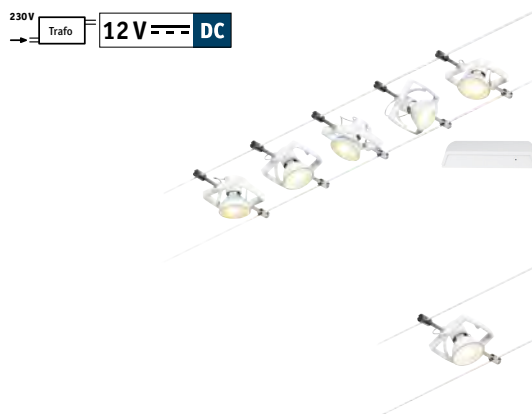

**Set Mac II**

max. 5×10W, GU5,3  
 230/12V, incl. ⚡ 60VA  
 ⚡ 160 mm 2,5 mm<sup>2</sup> ↔ 10 m  
 EAN 4000870 944325  
**944.32 new**

**Spot Mac II**

max. 10W, GU5,3  
 12V  
 ⚡ 160 mm  
 EAN 4000870 944332  
**944.33 new**

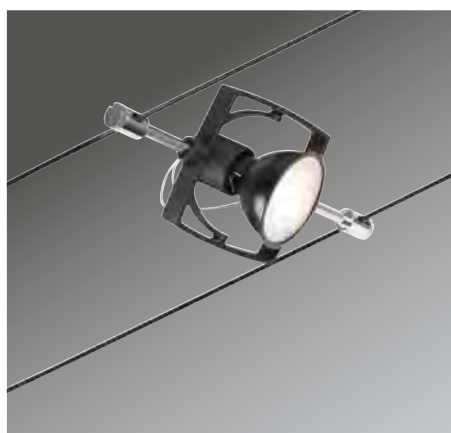

- 🌀 Black matt/Chrome 🧺 Plastic
- 🌀 Negro mate/Cromo 🧺 Plástico
- 🌀 Nero opaco/Cromo 🧺 Plastica

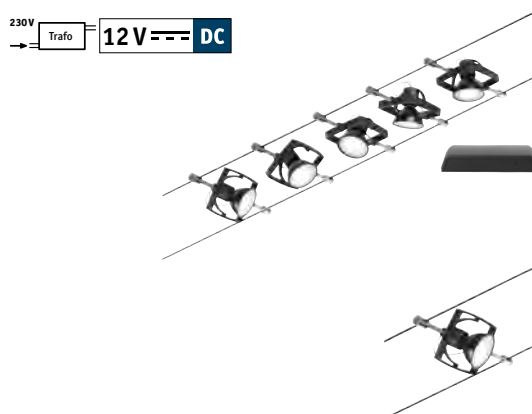

**Set Mac II**

max. 5×10W, GU5,3  
 230/12V, incl. ⚡ 60VA  
 ⚡ 160 mm 2,5 mm<sup>2</sup> ↔ 10 m  
 EAN 4000870 944349  
**944.34 new**

**Spot Mac II**

max. 10W, GU5,3  
 12V  
 ⚡ 160 mm  
 EAN 4000870 944356  
**944.35 new**



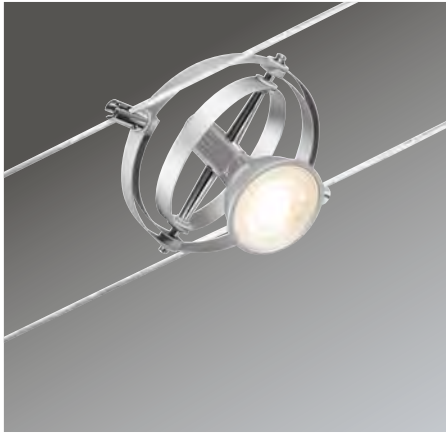

- ☞ Chrome matt ☐ Metal
- ☞ Cromo mate ☐ Metal
- ☞ Cromo opaco ☐ Metallo

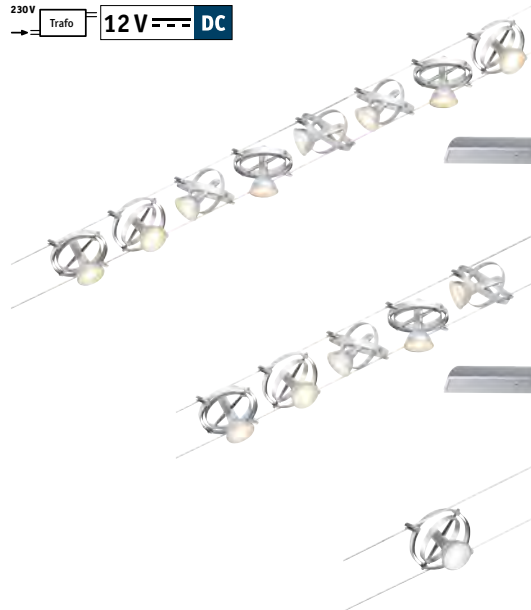
**Set Cardan**

max. 8×7,5 W, GU5,3  
 230/12V, incl. ⚡ 60 VA  
 ⚡ 125 mm 2,5 mm<sup>2</sup> ⇔ 10 m  
 EAN 4000870 944905  
**944.90 new**

**Set Cardan**

max. 5×10 W, GU5,3  
 230/12V, incl. ⚡ 60 VA  
 ⚡ 125 mm 2,5 mm<sup>2</sup> ⇔ 10 m  
 EAN 4000870 944363  
**944.36 new**

**SPOT Cardan**

max. 10 W, GU5,3  
 12 V  
 ⚡ 125 mm  
 EAN 4000870 944370  
**944.37 new**

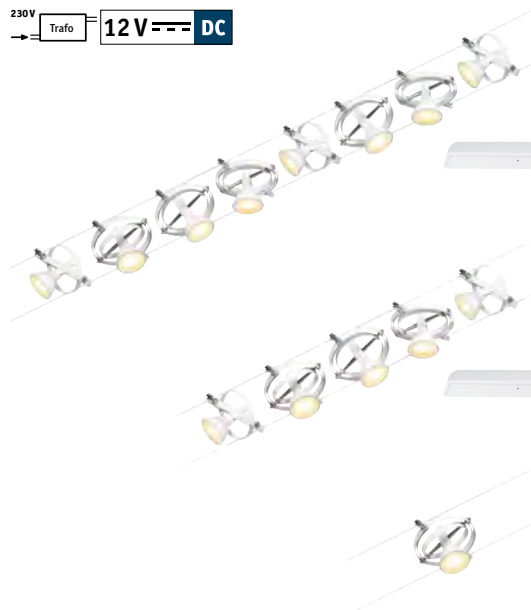

- ☞ Matt white ☐ Metal
- ☞ Blanco mate ☐ Metal
- ☞ Bianco opaco ☐ Metallo

**Set Cardan**

max. 8×7,5 W, GU5,3  
 230/12V, incl. ⚡ 60 VA  
 ⚡ 125 mm 2,5 mm<sup>2</sup> ⇔ 10 m  
 EAN 4000870 944929  
**944.92 new**

**Set Cardan**

max. 5×10 W, GU5,3  
 230/12V, incl. ⚡ 60 VA  
 ⚡ 125 mm 2,5 mm<sup>2</sup> ⇔ 10 m  
 EAN 4000870 944387  
**944.38 new**

**Spot Cardan**

max. 10 W, GU5,3  
 12 V  
 ⚡ 125 mm  
 EAN 4000870 944394  
**944.39 new**

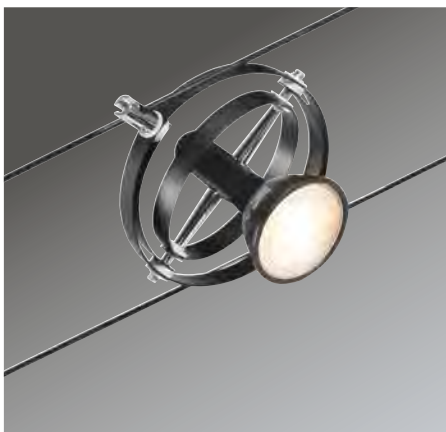

- ☞ Black matt ☐ Metal
- ☞ Negro mate ☐ Metal
- ☞ Nero opaco ☐ Metallo

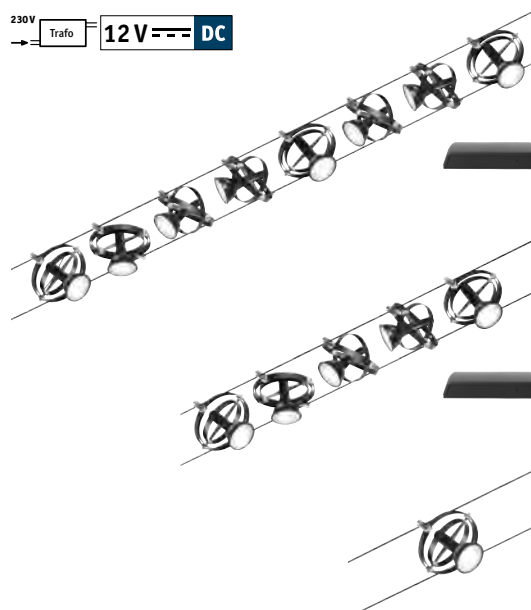
**Set Cardan**

max. 8×7,5 W, GU5,3  
 230/12V, incl. ⚡ 60 VA  
 ⚡ 125 mm 2,5 mm<sup>2</sup> ⇔ 10 m  
 EAN 4000870 944943  
**944.94 new**

**Set Cardan**

max. 5×10 W, GU5,3  
 230/12V, incl. ⚡ 60 VA  
 ⚡ 125 mm 2,5 mm<sup>2</sup> ⇔ 10 m  
 EAN 4000870 944400  
**944.40 new**

**Spot Cardan**

max. 10 W, GU5,3  
 12 V  
 ⚡ 125 mm  
 EAN 4000870 944417  
**944.41 new**





- ☞ Chrome matt ☐ Plastic
- ☞ Cromo mate ☐ Plástico
- ☞ Cromo opaco ☐ Plastica

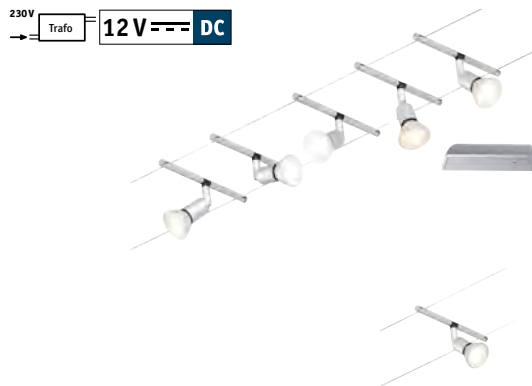

**Set Salt**  
 max. 5x10W, GU5,3  
 230/12V, incl. ⚡ 60VA  
 ⚡ 160 mm 2,5 mm<sup>2</sup> ↔ 10 m  
 EAN 4000870 944424  
**944.42 new**

**Spot Salt**  
 max. 10W, GU5,3  
 12V  
 ⚡ 160 mm  
 EAN 4000870 944431  
**944.43 new**



- ☞ Matt white/Chrome ☐ Plastic
- ☞ Blanco mate/Cromo ☐ Plástico
- ☞ Bianco opaco/Cromo ☐ Plastica

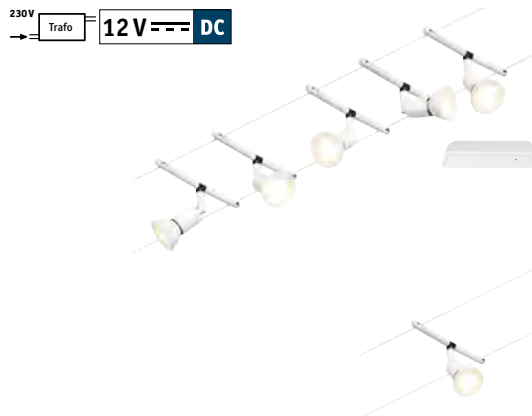

**Set Salt**  
 max. 5x10W, GU5,3  
 230/12V, incl. ⚡ 60VA  
 ⚡ 160 mm 2,5 mm<sup>2</sup> ↔ 10 m  
 EAN 4000870 944585  
**944.58 new**

**Spot Salt**  
 max. 10W, GU5,3  
 12V  
 ⚡ 160 mm  
 EAN 4000870 944455  
**944.45 new**



- ☞ Black ☐ Plastic
- ☞ Negro ☐ Plástico
- ☞ Nero ☐ Plastica

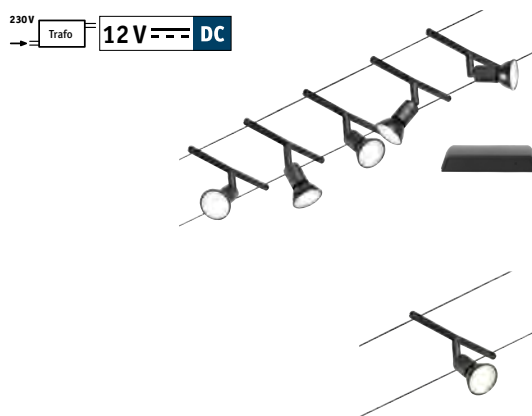

**Set Salt**  
 max. 5x10W, GU5,3  
 230/12V, incl. ⚡ 60VA  
 ⚡ 160 mm 2,5 mm<sup>2</sup> ↔ 10 m  
 EAN 4000870 944462  
**944.46 new**

**Spot Salt**  
 max. 10W, GU5,3  
 12V  
 ⚡ 160 mm  
 EAN 4000870 944479  
**944.47 new**

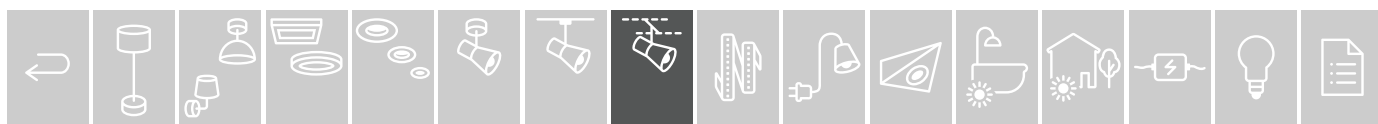



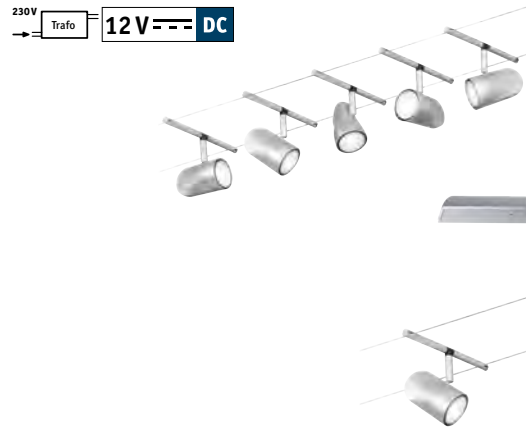

- ☞ Chrome matt/Chrome ☐ Plastic/Metal
- ☞ Cromo mate/Cromo ☐ Plástico/Metal
- ☞ Cromo opaco/Cromo ☐ Plastica/Metallo

**Set Cup**

max. 5×10W, GU5,3  
 230/12V, incl. ⚡ 60VA  
 ⚡ 160 mm ⚡ 124 mm ⚡ 58 mm  
 2,5 mm<sup>2</sup> ⚡ 100 mm ⚡ 58 mm  
 ⚡ 10 m  
 EAN 4000870 944653  
**944.65 new**

**Spot Cup**

max. 10W, GU5,3  
 12V  
 ⚡ 160 ⚡ 124 ⚡ 58 ⚡ 100  
 ⚡ 58 mm  
 EAN 4000870 944660  
**944.66 new**

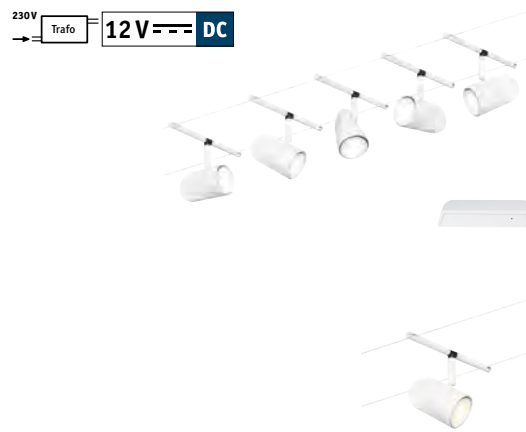

- ☞ Matt white/Chrome ☐ Plastic/Metal
- ☞ Blanco mate/Cromo ☐ Plástico/Metal
- ☞ Bianco opaco/Cromo ☐ Plastica/Metallo

**Set Cup**

max. 5×10W, GU5,3  
 230/12V, incl. ⚡ 60VA  
 ⚡ 160 mm ⚡ 124 mm ⚡ 58 mm  
 2,5 mm<sup>2</sup> ⚡ 100 mm ⚡ 58 mm  
 ⚡ 10 m  
 EAN 4000870 944677  
**944.67 new**

**Spot Cup**

max. 10W, GU5,3  
 12V  
 ⚡ 160 ⚡ 124 ⚡ 58 ⚡ 100  
 ⚡ 58 mm  
 EAN 4000870 944684  
**944.68 new**

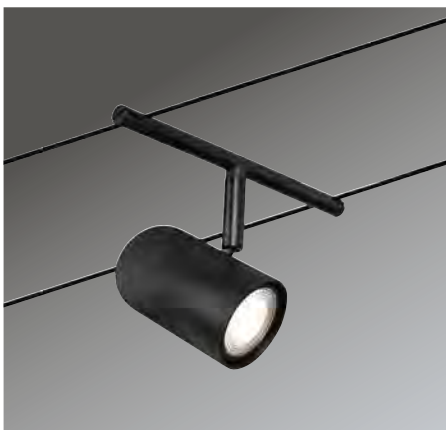

- ☞ Black matt/Chrome ☐ Plastic/Metal
- ☞ Negro mate/Cromo ☐ Plástico/Metal
- ☞ Nero opaco/Cromo ☐ Plastica/Metallo

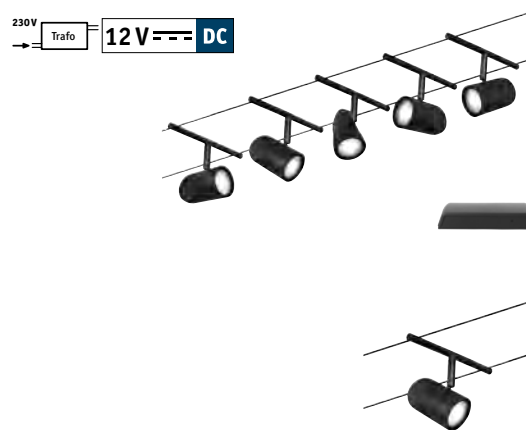
**Set Cup**

max. 5×10W, GU5,3  
 230/12V, incl. ⚡ 60VA  
 ⚡ 160 mm ⚡ 124 mm ⚡ 58 mm  
 2,5 mm<sup>2</sup> ⚡ 100 mm ⚡ 58 mm  
 ⚡ 10 m  
 EAN 4000870 944691  
**944.69 new**

**Spot Cup**

max. 10W, GU5,3  
 12V  
 ⚡ 160 ⚡ 124 ⚡ 58 ⚡ 100  
 ⚡ 58 mm  
 EAN 4000870 944707  
**944.70 new**





230V → Trafo = 12V --- DC



Perfect match  
283.30

- ☞ Chrome matt ☐ Plastic
- ☞ Cromo mate ☐ Plástico
- ☞ Cromo opaco ☐ Plastica

#### Set Sheela

max. 5x10W, GU5,3  
230/12V, incl. ⚡ 60VA  
± 160 mm 2,5 mm<sup>2</sup> ↔ 10 m  
EAN 4000870 944486  
**944.48 new**



#### Spot Sheela

max. 10W, GU5,3  
± 160 mm  
EAN 4000870 944493  
**944.49 new**



230V → Trafo = 12V --- DC

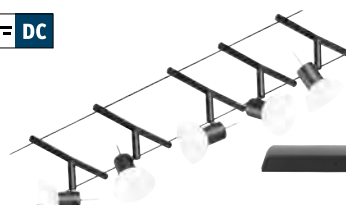

Perfect match  
283.30

- ☞ Black matt/Chrome ☐ Plastic
- ☞ Negro mate/Cromo ☐ Plástico
- ☞ Nero opaco/Cromo ☐ Plastica

#### Set Sheela

max. 5x10W, GU5,3  
230/12V, incl. ⚡ 60VA  
± 160 mm 2,5 mm<sup>2</sup> ↔ 10 m  
EAN 4000870 944509  
**944.50 new**



#### Spot Sheela

max. 10W, GU5,3  
± 160 mm  
EAN 4000870 944516  
**944.51 new**

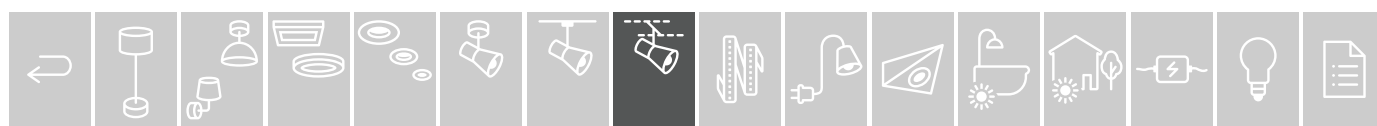

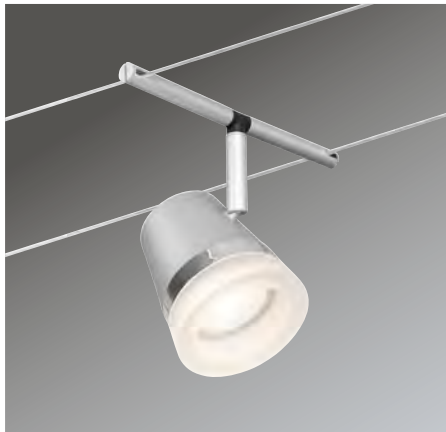

230V → Trafo = 12V --- DC



#### Set Cone

max. 5×10W, GU5,3   
 230/12V, incl. ⚡ 60VA  
 ⚡ 160 mm ⚡ 145 mm ⚡ 84 mm  
 2,5 mm<sup>2</sup> ↔ 94 mm ↗ 84 mm ↔ 10 m  
 EAN 4000870 944592  
**944.59 new**

#### Spot Cone

max. 10W, GU5,3   
 12V  
 ⚡ 160 ⚡ 145 ⚡ 84 ↔ 94 ↗ 84 mm  
 EAN 4000870 944608  
**944.60 new**

🌀 Chrome matt/Chrome 🧺 Plastic/Metal  
 🌀 Cromo mate/Cromo 🧺 Plástico/Metal  
 🌀 Cromo opaco/Cromo 🧺 Plastica/Metallo



230V → Trafo = 12V --- DC



#### Set Cone

max. 5×10W, GU5,3   
 230/12V, incl. ⚡ 60VA  
 ⚡ 160 mm ⚡ 145 mm ⚡ 84 mm  
 2×2,5 mm<sup>2</sup> ↔ 94 mm ↗ 84 mm  
 ↔ 10 m  
 EAN 4000870 944615  
**944.61 new**

#### Spot Cone

max. 10W, GU5,3   
 12V  
 ⚡ 160 ⚡ 145 ⚡ 84 ↔ 94 ↗ 84 mm  
 EAN 4000870 944622  
**944.62 new**

🌀 Matt white/Chrome 🧺 Plastic/Metal  
 🌀 Blanco mate/Cromo 🧺 Plástico/Metal  
 🌀 Bianco opaco/Cromo 🧺 Plastica/Metallo



230V → Trafo = 12V --- DC



#### Set Cone

max. 5×10W, GU5,3   
 230/12V, incl. ⚡ 60VA  
 ⚡ 160 mm ⚡ 145 mm ⚡ 84 mm  
 2,5 mm<sup>2</sup> ↔ 94 mm ↗ 84 mm ↔ 10 m  
 EAN 4000870 944639  
**944.63 new**

#### Spot Cone

max. 10W, GU5,3   
 12V  
 ⚡ 160 ⚡ 145 ⚡ 84 ↔ 94 ↗ 84 mm  
 EAN 4000870 944646  
**944.64 new**

🌀 Black matt/Chrome 🧺 Plastic/Metal  
 🌀 Negro mate/Cromo 🧺 Plástico/Metal  
 🌀 Nero opaco/Cromo 🧺 Plastica/Metallo



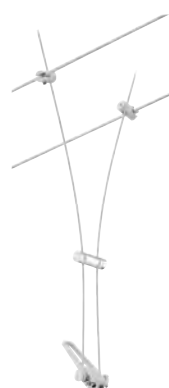
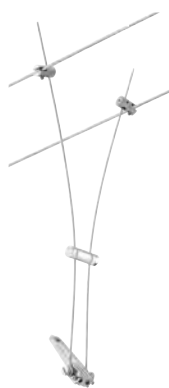

**Spot Comet**

max. 50 W, GU5,3  
12 V  
∅310 ∅28 ∅10 mm  
EAN 4000870 944875  
**944.87 new**

- 🔩 Chrome 🏠 Metal
- 🔩 Cromo 🏠 Metal
- 🔩 Cromo 🏠 Metallo



**Spot Comet**

max. 50 W, GU5,3  
12 V  
∅310 ∅28 ∅10 mm  
EAN 4000870 944882  
**944.88 new**

- 🔩 White 🏠 Metal
- 🔩 Blanco 🏠 Metal
- 🔩 Bianco 🏠 Metallo



**Spot Comet**

max. 50 W, GU5,3  
12 V  
∅310 ∅28 ∅10 mm  
EAN 4000870 944899  
**944.89 new**

- 🔩 Black 🏠 Metal
- 🔩 Negro 🏠 Metal
- 🔩 Nero 🏠 Metallo





Chrome matt/Chrome Metal  
 Cromo mate/Cromo Metal  
 Cromo opaco/Cromo Metallo

230V → Trafo = 12V DC

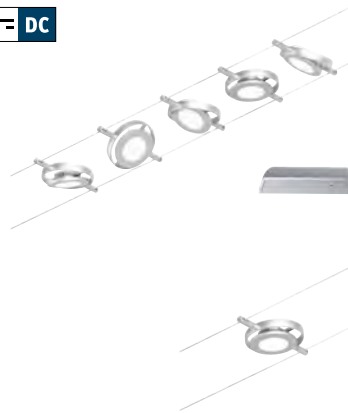

#### Set Round Mac

incl. 5×4,5W  
 5×450 lm, 3.000 K  
 230/12V, incl. 60 VA  
 160 mm 2,5 mm<sup>2</sup> ↔10 m  
 EAN 4000870 944141  
**944.14 new**

#### Spot Round Mac

incl. 1×4,5W  
 450 lm, 3.000 K  
 12V  
 160 ↑24 ø102 mm  
 EAN 4000870 944158  
**944.15 new**



White/Chrome Metal  
 Blanco/Cromo Metal  
 Bianco/Cromo Metallo

230V → Trafo = 12V DC



#### Set Round Mac

incl. 5×4,5W  
 5×450 lm, 3.000 K  
 230/12V, incl. 60 VA  
 160 mm 2,5 mm<sup>2</sup> ↔10 m  
 EAN 4000870 944165  
**944.16 new**

#### Spot Round Mac

incl. 1×4,5W  
 450 lm, 3.000 K  
 12V  
 160 ↑24 ø102 mm  
 EAN 4000870 944172  
**944.17 new**



Black matt/Chrome Metal  
 Negro mate/Cromo Metal  
 Nero opaco/Cromo Metallo

230V → Trafo = 12V DC

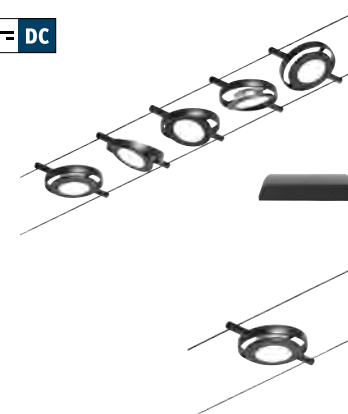

#### Set Round Mac

incl. 5×4,5W  
 5×450 lm, 3.000 K  
 230/12V, incl. 60 VA  
 160 mm 2,5 mm<sup>2</sup> ↔10 m  
 EAN 4000870 944189  
**944.18 new**

#### Spot Round Mac

incl. 1×4,5W  
 450 lm, 3.000 K  
 12V  
 160 ↑24 ø102 mm  
 EAN 4000870 944196  
**944.19 new**





- 🌀 Chrome matt/Chrome 🧱 Metal
- 🌀 Cromo mate/Cromo 🧱 Metal
- 🌀 Cromo opaco/Cromo 🧱 Metallo

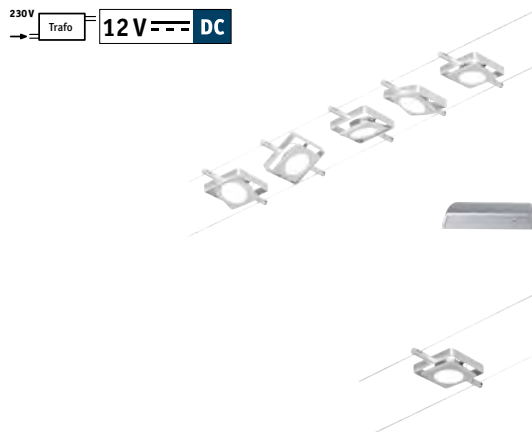

**Set MacLED**

incl. 5×4,5W  
 5×450 lm, 3.000 K  
 230/12V, incl. ⚡ 60 VA  
 ⚡ 160 mm ⚡ 24 mm 2,5 mm<sup>2</sup>  
 ⇄92 mm ⇄92 mm ⇄10 m  
 EAN 4000870 944202  
**944.20 new**

**Spot MacLED**

incl. 1×4,5W  
 450 lm, 3.000 K  
 12 V  
 ⚡ 160 mm ⚡ 24 mm 2,5 mm<sup>2</sup>  
 ⇄92 mm ⇄92 mm ⇄10 m  
 EAN 4000870 944219  
**944.21 new**



- 🌀 White/Chrome 🧱 Metal
- 🌀 Blanco/Cromo 🧱 Metal
- 🌀 Bianco/Cromo 🧱 Metallo

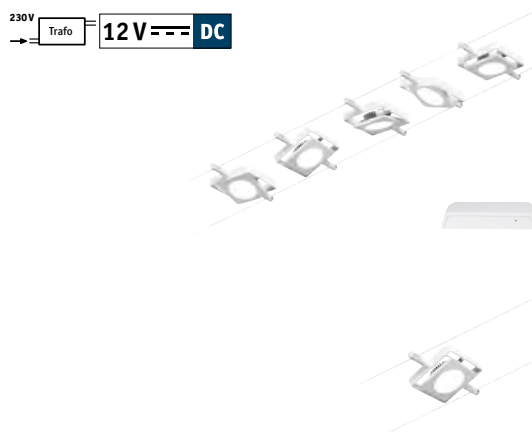

**Set MacLED**

incl. 5×4,5W  
 5×450 lm, 3.000 K  
 230/12V, incl. ⚡ 60 VA  
 ⚡ 160 mm ⚡ 24 mm 2,5 mm<sup>2</sup>  
 ⇄92 mm ⇄92 mm ⇄10 m  
 EAN 4000870 944226  
**944.22 new**

**Spot MacLED**

incl. 1×4,5W  
 450 lm, 3.000 K  
 12 V  
 ⚡ 160 mm ⚡ 24 mm 2,5 mm<sup>2</sup>  
 ⇄92 mm ⇄92 mm ⇄10 m  
 EAN 4000870 944233  
**944.23 new**

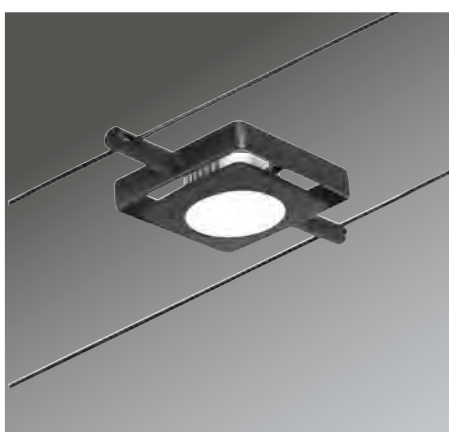

- 🌀 Black matt/Chrome 🧱 Metal
- 🌀 Negro mate/Cromo 🧱 Metal
- 🌀 Nero opaco/Cromo 🧱 Metallo

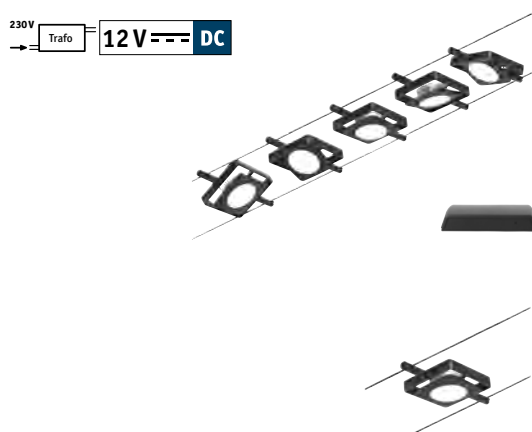

**Set MacLED**

incl. 5×4,5W  
 5×450 lm, 3.000 K  
 230/12V, incl. ⚡ 60 VA  
 ⚡ 160 mm ⚡ 24 mm 2,5 mm<sup>2</sup>  
 ⇄92 mm ⇄92 mm ⇄10 m  
 EAN 4000870 944240  
**944.24 new**

**Spot MacLED**

incl. 1×4,5W  
 450 lm, 3.000 K  
 12 V  
 ⚡ 160 mm ⚡ 24 mm 2,5 mm<sup>2</sup>  
 ⇄92 mm ⇄92 mm ⇄10 m  
 EAN 4000870 944257  
**944.25 new**

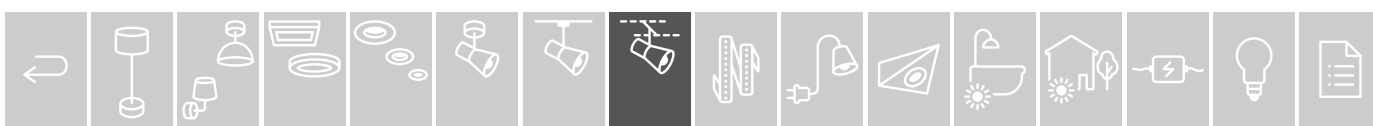

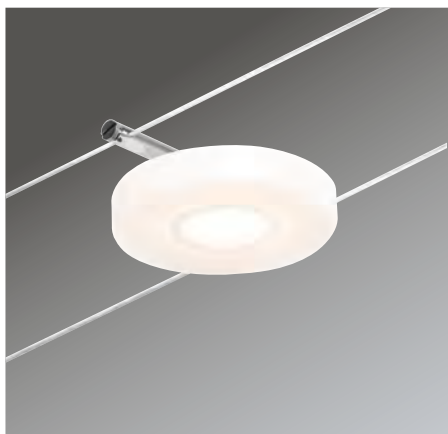

230V → Trafo = 12V --- DC



#### Set DiscLED

incl. 5×4,5W  
5×450lm, 3.000K  
230/12V, incl. ⚡ 60VA  
⊕ ⊖ 160mm ⊕ 38mm ∅130mm  
2,5mm<sup>2</sup> ↔ 10m  
EAN 4000870 944264  
**944.26 new**

#### Spot DiscLED

incl. 1×4,5W  
450lm, 3.000K  
12V  
⊕ ⊖ 160 ⊕ 38 ∅130mm  
EAN 4000870 944271  
**944.27 new**

- 🌀 Satin 🗍 Metal/Plastic
- 🌀 Satinado 🗍 Metal/Plástico
- 🌀 Satinato 🗍 Metallo/Plastica







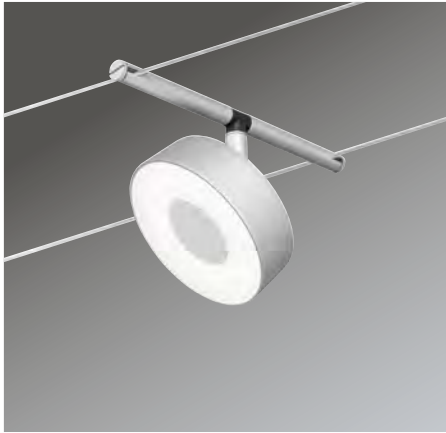

☞ Chrome matt/Chrome ☞ Plastic/Metal  
 ☞ Cromo mate/Cromo ☞ Plástico/Metal  
 ☞ Cromo opaco/Cromo ☞ Plastica/Metallo

230V → Trafo = 12V --- DC



#### Set Circle

incl. 5×5 W  
 5×400 lm, 3.000 K  
 230/12V, incl. ⚡ 60 VA  
 ⚡ 160 mm ⚡ 96 mm ⚡ 99 mm  
 2,5 mm<sup>2</sup> ⚡ 5 m  
 EAN 4000870 944752  
**944.75 new**

#### Spot Circle

incl. 1×5 W  
 400 lm, 3.000 K  
 12 V  
 ⚡ 160 ⚡ 96 ⚡ 99 mm  
 EAN 4000870 944769  
**944.76 new**

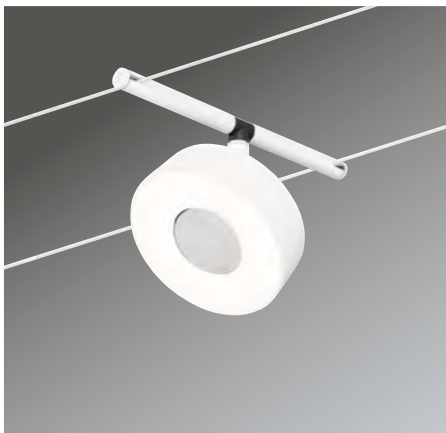

☞ Matt white/Chrome ☞ Plastic/Metal  
 ☞ Blanco mate/Cromo ☞ Plástico/Metal  
 ☞ Bianco opaco/Cromo ☞ Plastica/Metallo

230V → Trafo = 12V --- DC



#### Set Circle

incl. 5×5 W  
 5×400 lm, 3.000 K  
 230/12V, incl. ⚡ 60 VA  
 ⚡ 160 mm ⚡ 96 mm ⚡ 99 mm  
 2,5 mm<sup>2</sup> ⚡ 5 m  
 EAN 4000870 944776  
**944.77 new**

#### Spot Circle

incl. 1×5 W  
 400 lm, 3.000 K  
 12 V  
 ⚡ 160 ⚡ 96 ⚡ 99 mm  
 EAN 4000870 944783  
**944.78 new**



☞ Black matt/Chrome ☞ Plastic/Metal  
 ☞ Negro mate/Cromo ☞ Plástico/Metal  
 ☞ Nero opaco/Cromo ☞ Plastica/Metallo

230V → Trafo = 12V --- DC



#### Set Circle

incl. 5×5 W  
 5×400 lm, 3.000 K  
 230/12V, incl. ⚡ 60 VA  
 ⚡ 160 mm ⚡ 96 mm ⚡ 99 mm  
 2,5 mm<sup>2</sup> ⚡ 5 m  
 EAN 4000870 944790  
**944.79 new**

#### Spot Circle

incl. 1×5 W  
 400 lm, 3.000 K  
 12 V  
 ⚡ 160 ⚡ 96 ⚡ 99 mm  
 EAN 4000870 944806  
**944.80 new**



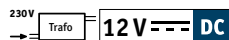
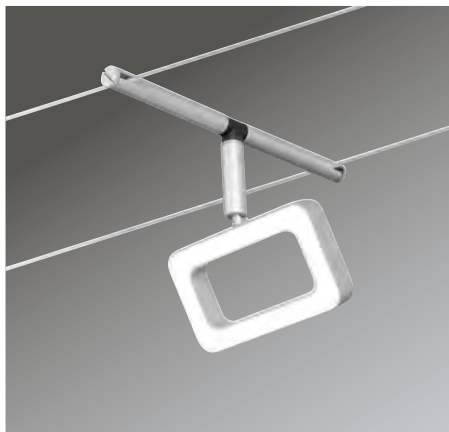

**Set Frame**

incl. 5×4,8W  
5×400lm, 3.000 K  
230/12V, incl. ⚡ 60 VA  
⊕160 mm ⊕130 mm 2,5 mm<sup>2</sup>  
↔104 mm ↗16 mm ↔5 m  
EAN 4000870 944813  
**944.81 new**

**Spot Frame**

incl. 1×4,8W  
400lm, 3.000 K  
12V  
⊕160 ⊕130 ↔104 ↗16 mm  
EAN 4000870 944820  
**944.82 new**

- 🌀 Chrome matt/Chrome 📦 Plastic/Metal
- 🌀 Cromo mate/Cromo 📦 Plástico/Metal
- 🌀 Cromo opaco/Cromo 📦 Plastica/Metallo

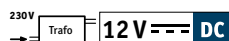
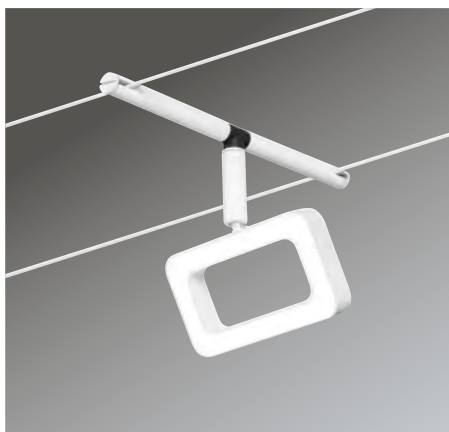

**Set Frame**

incl. 5×4,8W  
5×400lm, 3.000 K  
230/12V, incl. ⚡ 60 VA  
⊕160 mm ⊕130 mm 2,5 mm<sup>2</sup>  
↔104 mm ↗16 mm ↔5 m  
EAN 4000870 944837  
**944.83 new**

**Spot Frame**

incl. 1×4,8W  
400lm, 3.000 K  
12V  
⊕160 ⊕130 ↔104 ↗16 mm  
EAN 4000870 944844  
**944.84 new**

- 🌀 Matt white/Chrome 📦 Plastic/Metal
- 🌀 Blanco mate/Cromo 📦 Plástico/Metal
- 🌀 Bianco opaco/Cromo 📦 Plastica/Metallo

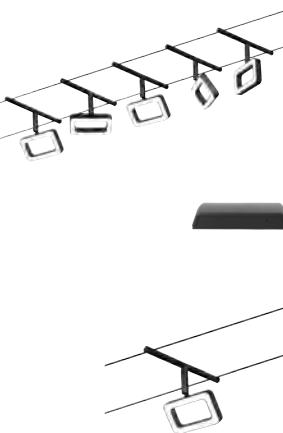
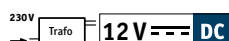
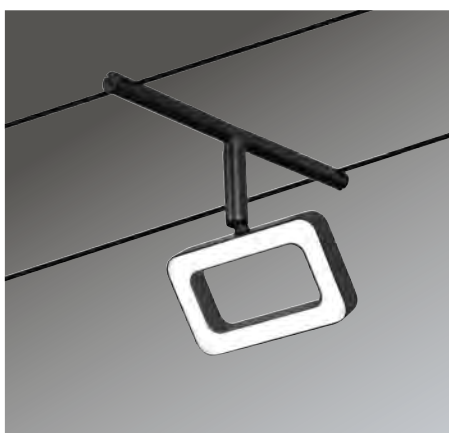

**Set Frame**

incl. 5×4,8W  
5×400lm, 3.000 K  
230/12V, incl. ⚡ 60 VA  
⊕160 mm ⊕130 mm 2,5 mm<sup>2</sup>  
↔104 mm ↗16 mm ↔5 m  
EAN 4000870 944851  
**944.85 new**

**Spot Frame**







incl. 1×4,8W  
400lm, 3.000 K  
12V  
⊕160 ⊕130 ↔104 ↗16 mm  
EAN 4000870 944868  
**944.86 new**

- 🌀 Black matt/Chrome 📦 Plastic/Metal
- 🌀 Negro mate/Cromo 📦 Plástico/Metal
- 🌀 Nero opaco/Cromo 📦 Plastica/Metallo









230V  Trafo **12V DC**









 Chrome matt  Plastic  
 Cromo mate  Plástico  
 Cromo opaco  Plastica





 Matt white  Plastic  
 Blanco mate  Plástico  
 Bianco opaco  Plastica

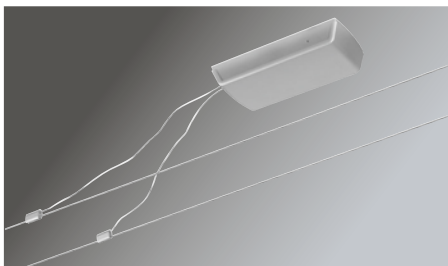

 Black matt  Plastic  
 Negro mate  Plástico  
 Nero opaco  Plastica



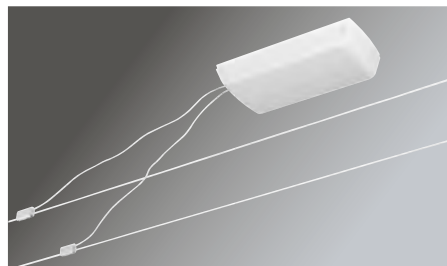

#### Basic Set Corduo

max. 60 W   
 230/12 V, incl.  60 VA  
 $\updownarrow 47$  mm  $\leftrightarrow 2,5$  mm<sup>2</sup>  $\leftrightarrow 115$  mm  $\curvearrowright 240$  mm  $\leftrightarrow 12$  m  
 EAN 4000870 944288  
**944.28 new**



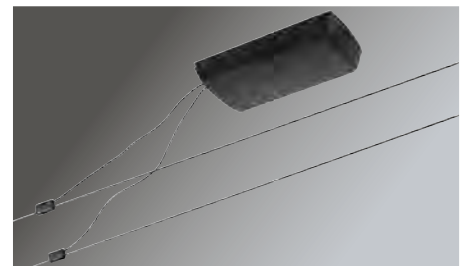

#### Basic Set Corduo

max. 60 W   
 230/12 V, incl.  60 VA  
 $\updownarrow 47$  mm  $\leftrightarrow 2,5$  mm<sup>2</sup>  $\leftrightarrow 115$  mm  $\curvearrowright 240$  mm  $\leftrightarrow 12$  m  
 EAN 4000870 944295  
**944.29 new**





#### Basic Set Corduo

max. 60 W   
 230/12 V, incl.  60 VA  
 $\updownarrow 47$  mm  $\leftrightarrow 2,5$  mm<sup>2</sup>  $\leftrightarrow 115$  mm  $\curvearrowright 240$  mm  $\leftrightarrow 12$  m  
 EAN 4000870 944967  
**944.96 new**





#### Driver Corduo

max. 60 W   
 230/12 V, incl.  60 VA  
 $\updownarrow 47$   $\leftrightarrow 240$   $\curvearrowright 115$  mm  
 EAN 4000870 978382  
**978.38 new**



#### Driver Corduo

max. 60 W   
 230/12 V, incl.  60 VA  
 $\updownarrow 47$   $\leftrightarrow 240$   $\curvearrowright 115$  mm  
 EAN 4000870 978399  
**978.39 new**



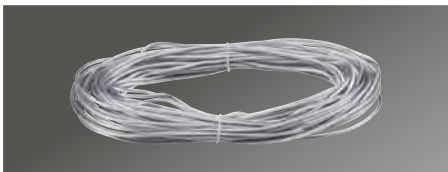

#### Driver Corduo

max. 60 W   
 230/12 V, incl.  60 VA  
 $\updownarrow 47$   $\leftrightarrow 240$   $\curvearrowright 115$  mm  
 EAN 4000870 978405  
**978.40 new**



#### Corduo

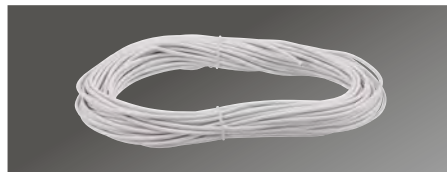

2,5 mm<sup>2</sup>  $\leftrightarrow 20$  m  
 EAN 4000870 945896  
**945.89 new**

 Transparent  
 Transparente  
 Trasparente



#### Corduo

2,5 mm<sup>2</sup>  $\leftrightarrow 20$  m  
 EAN 4000870 945919  
**945.91 new**

 White  
 Blanco  
 Bianco



#### Corduo

2,5 mm<sup>2</sup>  $\leftrightarrow 20$  m  
 EAN 4000870 945933  
**945.93 new**

 Black  
 Negro  
 Nero





230V → Trafo = 12V --- DC



**Set TunLED**

incl. 5×4 W  
 5×360 lm, 2.700 K  
 230/12V, incl. ⚡ 30 VA  
 ⚙️ 160 mm 1,5 mm<sup>2</sup> ↔ 10 m  
 EAN 4000870 039809  
**3980**

- 🌀 White/Chrome matt 📦 Plastic
- 🌀 Blanco/Cromo mate 📦 Plástico
- 🌀 Bianco/Cromo opaco 📦 Plastica



230V → Trafo = 12V --- DC



**Set TubeLED**

incl. 5×4 W  
 5×360 lm, 2.700 K  
 230/12V, incl. ⚡ 30 VA  
 ⚙️ 160 mm 2,5 mm<sup>2</sup> ↔ 10 m  
 EAN 4000870 039816  
**3981**

- 🌀 White/Black/Chrome 📦 Plastic
- 🌀 Blanco/Negro/Cromo 📦 Plástico
- 🌀 Bianco/Nero/Cromo 📦 Plastica





230V → Trafo = 12V --- DC



#### Set Clear

incl. 5×4 W  
 5×300 lm, 2.700 K  
 230/12V, incl. ⚡ 30 VA  
 ⚙️ 160 mm 2,5 mm<sup>2</sup> ↔ 10 m  
 EAN 4000870 944578  
**944.57 new**

- 🌀 Black/Chrome 📦 Plastic
- 🌀 Negro/Cromo 📦 Plástico
- 🌀 Nero/Cromo 📦 Plastica





230V **12V** **AC**

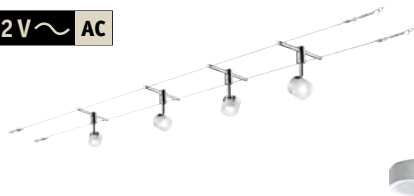

**Set Stage**

incl. 4x5W  
 4x400 lm, 2.700 K  
 230/12V, incl. 30 VA  
 160 mm 2,5 mm<sup>2</sup> ⇔ 10 m  
 EAN 4000870 940808  
**940.80**

- White/Chrome Metal/Glass
- Blanco/Cromo Metal/Cristal
- Bianco/Cromo Metallo/Vetro



**Perfect match**  
 = 398



230V **12V** **AC**

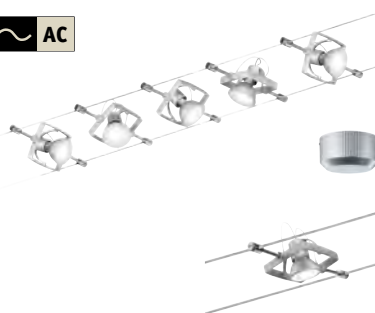

**Set Mac II**

max. 5x10 W, GU5,3  
 230/12V, incl. 60 VA  
 160 mm 2,5 mm<sup>2</sup> ⇔ 10 m  
 EAN 4000870 941331  
**941.33**

**Spot Mac II**

max. 10 W, GU5,3  
 12V  
 55 ⇔ 70 ⇔ 70 mm  
 EAN 4000870 941324  
**941.32**



- Chrome matt Metal/Plastic
- Cromo mate Metal/Plástico
- Cromo opaco Metallo/Plastica





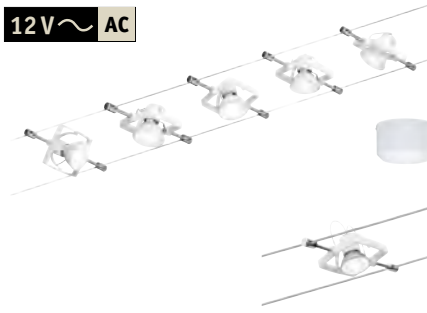





230V  **12V**  **AC**

**Set Mac II**

max. 5×10 W, GU5,3   
 230/12 V, incl.  60 VA  
 ⌀ 160 mm 2,5 mm<sup>2</sup> ⇔ 10 m  
 EAN 4000870 941348  
**941.34**

**Spot Mac II**



max. 10 W, GU5,3   
 12 V  
 ⌀ 160 ⇔ 70 mm  
 EAN 4000870 941485  
**941.48**

-  Matt white/Chrome  Plastic
-  Blanco mate/Cromo  Plástico
-  Bianco opaco/Cromo  Plastica



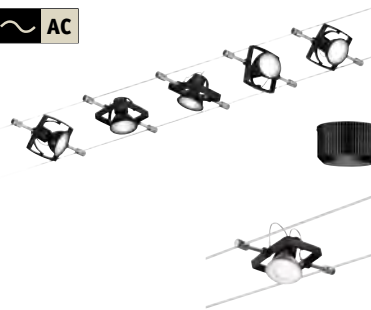





230V  **12V**  **AC**

**Set Mac II**

max. 5×10 W, GU5,3   
 230/12 V, incl.  60 VA  
 ⌀ 160 mm 2,5 mm<sup>2</sup> ⇔ 10 m  
 EAN 4000870 942901  
**942.90**

**Spot Mac II**

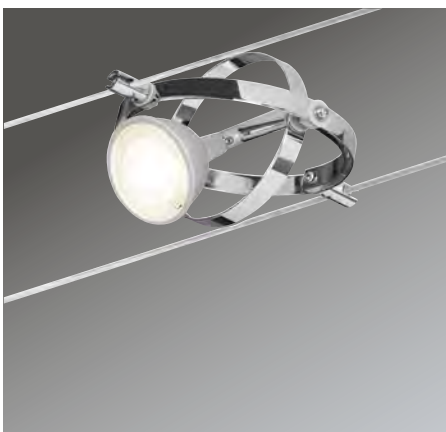

max. 10 W, GU5,3   
 12 V  
 ⌀ 55 ⇔ 70 ⇔ 70 mm  
 EAN 4000870 942918  
**942.91**

-  Black matt  Metal/Plastic
-  Negro mate  Metal/Plástico
-  Nero opaco  Metallo/Plastica











230V  **12V**  **AC**

**Set Cardan**

max. 8×10 W, GU5,3   
 230/12 V, incl.  80 VA  
 ⌀ 125 mm 2,5 mm<sup>2</sup> ⇔ 10 m  
 EAN 4000870 941539  
**941.53**

**Set Cardan**

max. 4×10 W, GU5,3   
 230/12 V, incl.  60 VA  
 ⌀ 125 mm 2,5 mm<sup>2</sup> ⇔ 10 m  
 EAN 4000870 941447  
**941.44**

-  Chrome matt/Chrome  Metal
-  Cromo mate/Cromo  Metal
-  Cromo opaco/Cromo  Metallo





230V **12V** ~ AC

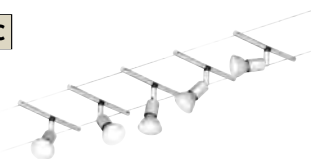

**Set Spice Salt**

max. 5×10W, GU5,3  
 230/12V, incl. 60VA  
 ⚓ 160 mm ⚖ 65 mm ⌀28 mm  
 2,5 mm<sup>2</sup> ⇔ 185 mm ↻55 mm  
 ⇔10 m  
 EAN 4000870 941454  
**941.45**

- Chrome matt Metal
- Cromo mate Metal
- Cromo opaco Metallo



230V **12V** ~ AC



**Set Sheela**

max. 5×10W, GU5,3  
 230/12V, incl. 60VA  
 ⚓ 160 mm 2,5 mm<sup>2</sup> ⇔10 m  
 EAN 4000870 941362  
**941.36**

- Chrome matt/Opal Metal/Glass
- Cromo mate/Opal Metal/Cristal
- Cromo opaco/Opale Metallo/Vetro







⌘ Chrome/⊞ Metal/⊞ Metal/Glass  
 ⌘ Cromo/Satinado ⊞ Metal/Cristal  
 ⌘ Cromo/Satinato ⊞ Metallo/Vetro

 Perfect match  
 ✓  
 283.29



### Spot Colmar

max. 10 W, GU4  
 12 V  
 ⚙️ 160 ⚙️ 30 ⚙️ 110 ⚙️ 85  
 ⚙️ 80 mm  
 EAN 4000870 941386  
**941.38**



⌘ Chrome ⊞ Metal  
 ⌘ Cromo ⊞ Metal  
 ⌘ Cromo ⊞ Metallo

230 V  12 V ~ AC



### Set Togo

max. 4×10 W, GU5,3  
 230/12 V, incl.  60 VA  
 ⚙️ 160 mm 2,5 mm<sup>2</sup> ↔ 10 m  
 EAN 4000870 941461  
**941.46**



### Spot Togo

max. 10 W, GU5,3  
 12 V  
 ⚙️ 160 ⚙️ 80 ⚙️ 51 mm  
 EAN 4000870 941478  
**941.47**



⌘ Chrome ⊞ Metal  
 ⌘ Cromo ⊞ Metal  
 ⌘ Cromo ⊞ Metallo



### Spot Comet

max. 50 W, GU5,3  
 12 V  
 ⚙️ 300 ⚙️ 300 mm  
 EAN 4000870 971130  
**971.1229**





Combine your own personal lighting system  
 Combine usted mismo su sistema de luz personal  
 Scegliete voi stessi le combinazioni per il vostro sistema d'illuminazione personalizzato

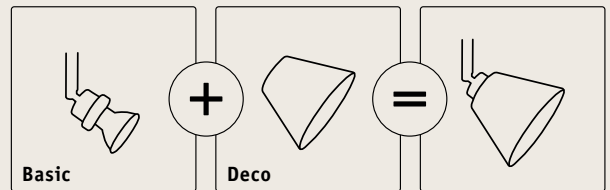

**Spot Basic**  
 max. 10 W, GU5,3  
 12 V  
 ⌀160 ⌀30  
 ⌀130 ↔95 ↗75 mm  
 EAN 4000870 941416  
**941.41**

Perfect match  
 ✓  
 283.30

- 🌀 Chrome matt 🧱 Metal
- 🌀 Cromo mate 🧱 Metal
- 🌀 Cromo opaco 🧱 Metallo



**Wolbi**

max. 50 W  
 ⚡80 ø90 mm  
 EAN 4000870 600115

**600.11**

- 👉 Dichroic 📦 Glass
- 👉 Dicroico 📦 Cristal
- 👉 Dicroico 📦 Vetro

**Vico**

max. 50 W  
 ⚡95 ø80 mm  
 EAN 4000870 953570

**953.57**

- 👉 Clear 📦 Glass
- 👉 Transparente 📦 Cristal
- 👉 Trasparente 📦 Vetro

**Twice**

max. 50 W  
 ⚡70 ø100 mm  
 EAN 4000870 701744

**701.74**

- 👉 Clear/Opaque 📦 Glass
- 👉 Transparente/Opaco 📦 Cristal
- 👉 Trasparente/Opaco 📦 Vetro

**Vento**

max. 50 W  
 ⚡95 ø80 mm  
 EAN 4000870 953594

**953.59**

- 👉 Smoke glass 📦 Glass
- 👉 Vidrio ahumado 📦 Cristal
- 👉 Vetro opaco 📦 Vetro

**Vento**

max. 50 W  
 ⚡95 ø80 mm  
 EAN 4000870 953587

**953.58**

- 👉 Satin 📦 Glass
- 👉 Satinado 📦 Cristal
- 👉 Satinato 📦 Vetro

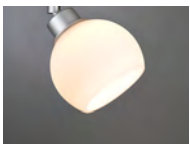
**Wolbi**

max. 50 W  
 ⚡70 ø90 mm  
 EAN 4000870 600559

**600.55**

- 👉 Opal 📦 Glass
- 👉 Opal 📦 Cristal
- 👉 Opale 📦 Vetro

**Quad**

max. 50 W  
 ⚡80 ø75 mm  
 EAN 4000870 600153

**600.15**

- 👉 White 📦 Glass
- 👉 Blanco 📦 Cristal
- 👉 Bianco 📦 Vetro

**Kegi**

max. 50 W  
 ⚡80 ø110 mm  
 EAN 4000870 600122

**600.12**

- 👉 White 📦 Glass
- 👉 Blanco 📦 Cristal
- 👉 Bianco 📦 Vetro

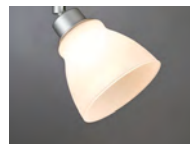
**Wolbi**

max. 50 W  
 ⚡80 ø90 mm  
 EAN 4000870 600078

**600.07**

- 👉 White 📦 Glass
- 👉 Blanco 📦 Cristal
- 👉 Bianco 📦 Vetro

**Zyli**

max. 50 W  
 ⚡80 ø70 mm  
 EAN 4000870 600047

**600.04**

- 👉 White 📦 Glass
- 👉 Blanco 📦 Cristal
- 👉 Bianco 📦 Vetro

**DecoSystems Diffusor**

max. 20 W  
 ⚡1,5 ø255 mm  
 EAN 4000870 954935

**954.93**

- 👉 Satin 📦 Plastic
- 👉 Satinado 📦 Plástico
- 👉 Satinato 📦 Plastica

**Tessa**

max. 50 W  
 ⚡152 ø255 mm  
 EAN 4000870 603499

**603.49**

- 👉 Dark brown 📦 Fabric
- 👉 Marrón oscuro 📦 Tela
- 👉 Marrone scuro 📦 Tessuto

**Tessa**

max. 50 W  
 ⚡152 ø255 mm  
 EAN 4000870 603505

**603.50**

- 👉 Caramel 📦 Fabric
- 👉 Caramelo 📦 Tela
- 👉 Caramello 📦 Tessuto

**Tessa**

max. 50 W  
 ⚡152 ø255 mm  
 EAN 4000870 603512

**603.51**

- 👉 Cream 📦 Fabric
- 👉 Crema 📦 Tela
- 👉 Crema 📦 Tessuto

**Tessa**

max. 50 W  
 ⚡152 ø255 mm  
 EAN 4000870 603529

**603.52**

- 👉 Light grey 📦 Fabric
- 👉 Gris claro 📦 Tela
- 👉 Grigio chiaro 📦 Tessuto

**Tessa**

max. 50 W  
 ⚡152 ø255 mm  
 EAN 4000870 603260

**603.26**

- 👉 White 📦 Fabric
- 👉 Blanco 📦 Tela
- 👉 Bianco 📦 Tessuto



- 🌀 Clear 🏠 Copper/Plastic
- 🌀 Transparente 🏠 Cobre/Plástico
- 🌀 Trasparente 🏠 Rame/Plastica



**Safety tension wire, insulated**  
**Cable tensor de seguridad, aislado**  
**Cavo tenditore di sicurezza, isolato**

2,5 mm<sup>2</sup> ⇔ 12 m  
 EAN 4000870 979693  
**979.069** 📦

4 mm<sup>2</sup> ⇔ 12 m  
 EAN 4000870 979556  
**979.055** 📦

6 mm<sup>2</sup> ⇔ 12 m  
 EAN 4000870 979471  
**979.047** 📦

4 mm<sup>2</sup> ⇔ 100 m  
 EAN 4000870 006566  
**979.057**

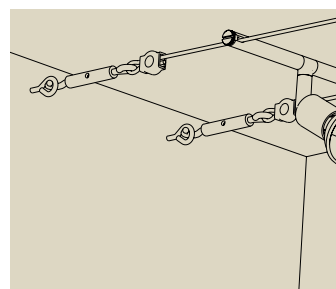

**Tension fitting kit, uninsulated**  
**Set de montaje de elementos de tensión, no aislado**  
**Set di montaggio a trazione, non isolato**

2x 4x 4x 4x

🌀 Chrome 🏠 Metal  
 🌀 Cromo 🏠 Metal  
 🌀 Cromo 🏠 Metallo

EAN 4000870 178034  
**178.03** 📦

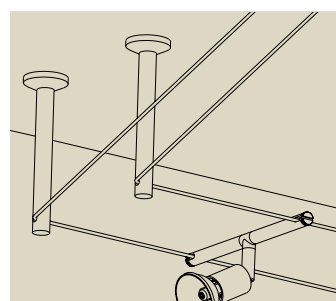

**Diverter / Suspension screw-fitted mount, 1 pair**  
**Diversor / Suspensión, para atornillar, 2 unidades**  
**Deviatore / Sospensione, da avvitare, 1 coppia**

🌀 Chrome matt 🏠 Metal  
 🌀 Cromo mate 🏠 Metal  
 🌀 Cromo opaco 🏠 Metallo

2x 6x 6x

⇕165 ø16 mm  
 EAN 4000870 178065  
**178.06** 📦

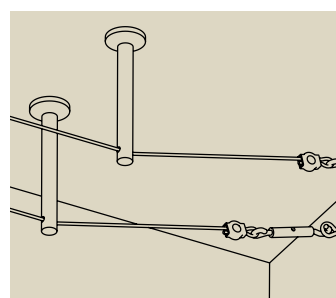

**Diverter / Suspension screw-fitted mount, 1 pair**  
**Diversor / Suspensión, para atornillar, 2 unidades**  
**Deviatore / Sospensione, da avvitare, 1 coppia**

🌀 Chrome 🏠 Metal  
 🌀 Cromo 🏠 Metal  
 🌀 Cromo 🏠 Metallo

2x 2x 2x

⇕165 ø16 mm  
 EAN 4000870 178249  
**178.24** 📦

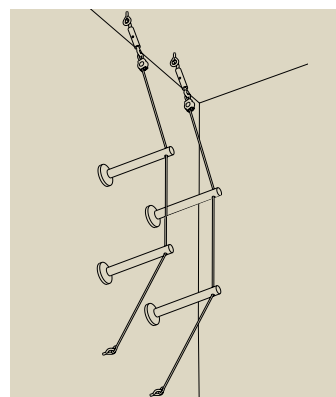

**Tension fitting kit**  
**Set de montaje de elementos de tensión**  
**Set di montaggio a trazione**

🌀 Chrome 🏠 Metal  
 🌀 Cromo 🏠 Metal  
 🌀 Cromo 🏠 Metallo

0 4x 2x 4x 4x 4x 4x

⇕165 ø16 mm  
 EAN 4000870 178348  
**178.34** 📦



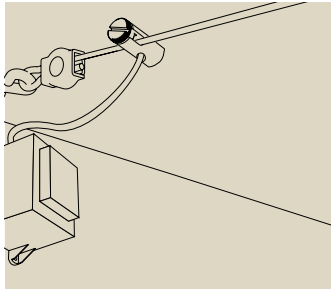

**Power Input, 1 pair**  
**Alimentación Eléctrica, 2 unidades**  
**Alimentazione, 1 coppia**



- 🔧 Chrome matt 

--	--	--	--

 Metal
- 🔧 Cromo mate 

--	--	--	--

 Metal
- 🔧 Cromo opaco 

--	--	--	--

 Metallo

max. 300 W  
 12 V  
 ⚙️ 30 mm ø12 mm 6 mm<sup>2</sup>  
 EAN 4000870 972830  
**972.83**

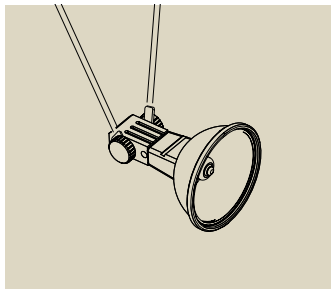

**Socket bulb fitting for wire systems**  
**Portalámparas Socket, para sistemas de cables**  
**Porta-lampada Socket per sistemi a cavi**



- 🔧 Black 

--	--	--	--

 Metal
- 🔧 Negro 

--	--	--	--

 Metal
- 🔧 Nero 

--	--	--	--

 Metallo

max. 35 W, G4  
 12 V  
 EAN 4000870 978412  
**978.41**



- 🔧 Black 

--	--	--	--

 Metal
- 🔧 Negro 

--	--	--	--

 Metal
- 🔧 Nero 

--	--	--	--

 Metallo

max. 50 W, GX5,3  
 12 V  
 EAN 4000870 978450  
**978.45**

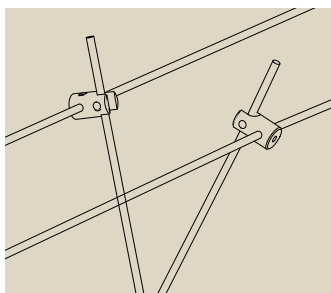

**Wire block for wire systems max. 150W / rod systems max. 300W, double pack**  
**Cilindro para sistemas de cables máx. 150W / Sistemas de barras máx. 300W pack de dos unidades**  
**Blocchetto del cavo per sistemi a cavi max. 150W / sistemi ad aste max. 300W in confezione doppia**



- 🔧 Chrome 

--	--	--	--

 Metal
- 🔧 Cromo 

--	--	--	--

 Metal
- 🔧 Cromo 

--	--	--	--

 Metallo

max. 150 W  
 12 V  
 EAN 4000870 978191  
**978.019**



# LED Strips & Profiles

215 MaxLED – 24 V System

230 YourLED – 12 V System

243 Complete Sets

252 Profiles

264 Mobile Strips –  
USB/Battery



## LED Strips

EN LED strips create favourite spaces

Realise your lighting ideas with the flexible, self-adhesive LED strips, which can be individually shortened in combination with matching Paulmann profiles. A wide range of accessories allows you to control the brightness or light colour of the MaxLED Strips via remote control, voice command, app or sensor.

ES Las strips LED convierten las estancias en los lugares preferidos de todos

Con las strips LED flexibles y autoadhesivas que se pueden acortar individualmente y los perfiles Paulmann a juego puede hacer realidad sus ideas de iluminación. Los múltiples accesorios le permiten controlar la luminosidad o las tonalidades de la luz de las strips MaxLED mediante mando a distancia, voz, aplicación o sensor.

IT Le Strips LED trasformano gli ambienti in luoghi del cuore

Con le Strips LED flessibili, autoadesive accorciabili in modo personalizzato e i profili Paulmann abbinati puoi realizzare le tue idee illuminotecniche. Con i versatili accessori puoi gestire la luminosità e i colori della luce delle tue Strips MaxLED tramite telecomando, comando vocale, app o sensore.



EN PoS: Easy to Shop! Easy and clear consumer instructions from initial sample to merchandise purchases

ES PdV: ¡Easy to Shop! Orientación clara y sencilla para el cliente final, desde la exposición de muestras hasta el artículo

IT Presso i punti vendita: Easy to Shop! Supporto al cliente finale semplice e comprensibile dalla campionatura alla merce





	YourLED ECO	YourLED	MaxLED 250	MaxLED 500	MaxLED 1000
<b>Lighting application</b> <b>Aplicación lumínica</b> <b>Applicazione della luce</b>	Oriented light Bazigerorientación Orientamento	Dekorative light Éclairage décoratif Decorativa	Dekorative light Éclairage décoratif Decorativa	Work light Luce di lavoro Werklicht	Room light Éclairage d'ambiance Kamerlicht
<b>Voltage/Output per metre</b> <b>Tensión/potencia por metro</b> <b>Tensione di funzionamento/ Potenza per metro</b>	12V 3,5 W/m	12V 3,5 W/m	24V 3,5 W/m	24V 6 W/m	24V 12 W/m
<b>Brightness in lumens per metre</b> <b>Luminosidad en lúmenes por metro</b> <b>Luminosità in Lumen per metro</b>	160 lm / m 160 lm / m	265 lm / m 265 lm / m	300 lm / m 300 lm / m	550 lm / m 550 lm / m	1100 lm / m 1100 lm / m
<b>Number of LEDs per metre</b> <b>Cantidad de LED por metro</b> <b>Numero LED per metro</b>	30 LED / m ∅ 10 mm	39 LED / m ∅ 10 mm	30 LED / m ∅ 12,5 mm	72 LED / m ∅ 12,5 mm	144 LED / m ∅ 12,5 mm
<b>Dimensions</b> <b>Medidas</b> <b>Dimensioni</b>	↔ max. 30 mm ≍ 100 mm ↔ max. 30 mm ≍ 100 mm	↔ max. 24 mm ≍ 75 mm ↔ max. 24 mm ≍ 75 mm	↔ max. 40 mm ≍ 167 mm ↔ max. 40 mm ≍ 167 mm	↔ max. 26 mm ≍ 83 mm ↔ max. 26 mm ≍ 83 mm	↔ max. 15 mm ≍ 41,5 mm ↔ max. 15 mm ≍ 41,5 mm
<b>With coating</b> <b>Con revestimiento</b> <b>Con rivestimento</b>		✓	✓	✓	✓
<b>Without coating</b> <b>Sin revestimiento</b> <b>Senza rivestimento</b>	✓		✓	✓	✓
<b>Light colour</b> <b>Tonalidad de la luz</b> <b>Colore della luce</b>	3000 K 4000 K RGB □ = 230, 232	3000 K 6000 K RGB □ = 231-232	2700 K 6500 K tunable white RGB □ = 216-217	2700 K 6500 K tunable white RGB □ = 218-220	2700 K 6500 K 2700 K 6500 K □ = 221
	□ = 230, 232	□ = 231-232	□ = 216-217	□ = 218-220	□ = 221



**With coating** – on furniture, in the kitchen & bathroom  
**Con revestimiento** – encima de muebles, en la cocina y el baño  
**Con rivestimento** – su mobili, in cucina e in bagno



**Without coating** – in furniture and profiles  
**Sin revestimiento** – en muebles y perfiles  
**Senza rivestimento** – in mobili e profili







## MaxLED

- ▶ The high luminance of our MaxLED LED strips offers innovative lighting options for living and working areas
  - ▶ The LED density in the strips ensure a continuous light look – perfect for use in profiles
  - ▶ 1 m of the MaxLED 1000 strip is comparable to the lighting effect of a 75 W incandescent light bulb
  - ▶ MaxLED is available as a basic set for later extension or as individual strips for custom configurations
  - ▶ Stick-on light: An adhesive strip ensures quick and easy, tool-free installation
- ▶ Con su luminosidad, las strips MaxLED abren posibilidades novedosas para la luz del hogar y del trabajo
  - ▶ Su alta densidad de LED crea un hilo continuo de luz: ideal para instalar en perfiles
  - ▶ La strip MaxLED 1000 de 1 m equivale al efecto lumínico de una bombilla incandescente de 75 W
  - ▶ MaxLED está disponible en juegos básicos ampliables o como strips individuales para las configuraciones deseadas
  - ▶ Luz para pegar: instalación rápida sin herramientas gracias a las tiras adhesivas en el dorso
- ▶ Grazie a un'elevata potenza luminosa, le strisce di LED MaxLED aprono scenari completamente nuovi per l'illuminazione generale di spazi abitativi e ambienti di lavoro
  - ▶ L'alta concentrazione di LED garantisce una luce continua, ideale per l'integrazione in profili
  - ▶ Una striscia MaxLED 1000 da 1 m assicura un effetto luminoso comparabile a quello di una lampada a incandescenza da 75 W
  - ▶ MaxLED in set di base ampliables o come strip singole per configurazioni personalizzabili
  - ▶ Luce incollabile: installazione rapida senza bisogno di attrezzi grazie alla striscia adesiva sul retro



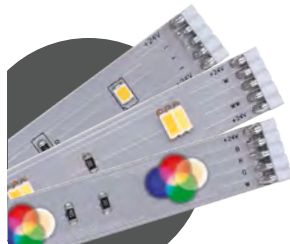

Silver Plastic  
 Plateado Plástico  
 Argento Plastica

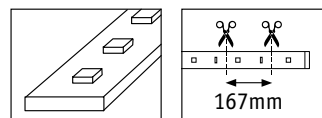

**MaxLED 250** 300 lm/m 30 LED/m  $\updownarrow$  3 mm  $\nearrow$  12,5 mm 230/24V

**warm white = 2.700 K**



**Set**

$\updownarrow$  3 m  $\xrightarrow{\text{max.}}$  5,5 m | 900 lm | 12 W | incl. 24 VA EAN 4000870 798522 **798.52**

**Strip**



$\updownarrow$  1 m | 300 lm | 4 W EAN 4000870 798539 **798.53**

$\updownarrow$  2,5 m | 750 lm | 10 W EAN 4000870 798546 **798.54**

$\updownarrow$  5 m | 1.500 lm | 19 W EAN 4000870 798553 **798.55**

**daylight = 6.500 K**



**Set**

$\updownarrow$  3 m  $\xrightarrow{\text{max.}}$  5,5 m | 900 lm | 12 W | incl. 24 VA EAN 4000870 798560 **798.56**

**Strip**



$\updownarrow$  1 m | 300 lm | 4 W EAN 4000870 798577 **798.57**

$\updownarrow$  2,5 m | 750 lm | 10 W EAN 4000870 798584 **798.58**

$\updownarrow$  5 m | 1.500 lm | 19 W EAN 4000870 798591 **798.59**

**tunable white = 2.700 - 6.500 K**



**Set**



$\updownarrow$  3 m  $\xrightarrow{\text{max.}}$  6 m | 810 lm | 11 W | incl. 24 VA EAN 4000870 798607 **798.60**

**Strip**



$\updownarrow$  1 m | 270 lm | 4 W EAN 4000870 798614 **798.61**

$\updownarrow$  2,5 m | 675 lm | 9 W EAN 4000870 798621 **798.62**

$\updownarrow$  5 m | 1.350 lm | 17,5 W EAN 4000870 798638 **798.63**

**RGBW – W = 3.000 K**



**Set**



$\updownarrow$  3 m  $\xrightarrow{\text{max.}}$  5 m | 810 lm | 20 W | incl. 36 VA EAN 4000870 798645 **798.64**

**Strip**



$\updownarrow$  1 m | 270 lm | 7 W EAN 4000870 798652 **798.65**

$\updownarrow$  2,5 m | 675 lm | 17 W EAN 4000870 798669 **798.66**

$\updownarrow$  5 m | 1.350 lm | 31,5 W EAN 4000870 798676 **798.67**



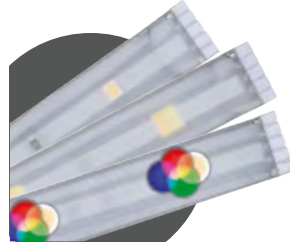

Silver Plastic  
 Plateado Plástico  
 Argento Plastica

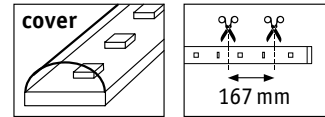

**MaxLED 250** 300 lm/m 30 LED/m  $\updownarrow$  3 mm  $\nearrow$  12,5 mm 230/24V

**warm white = 2.700 K**



**Set**

$\leftrightarrow$ 1,5 m	<u>max.</u> 5,5 m	450 lm	6 W	incl.		EAN 4000870 798683	<b>798.68</b>
$\leftrightarrow$ 3 m	<u>max.</u> 5,5 m	900 lm	12 W	incl.		EAN 4000870 798690	<b>798.69</b>

**Strip**



$\leftrightarrow$ 1 m		300 lm	4 W			EAN 4000870 798706	<b>798.70</b>
$\leftrightarrow$ 2,5 m		750 lm	10 W			EAN 4000870 798713	<b>798.71</b>

**daylight = 6.500 K**



**Set**

$\leftrightarrow$ 1,5 m	<u>max.</u> 5,5 m	450 lm	6 W	incl.		EAN 4000870 798720	<b>798.72</b>
$\leftrightarrow$ 3 m	<u>max.</u> 5,5 m	900 lm	12 W	incl.		EAN 4000870 798737	<b>798.73</b>

**Strip**



$\leftrightarrow$ 1 m		300 lm	4 W			EAN 4000870 798744	<b>798.74</b>
$\leftrightarrow$ 2,5 m		750 lm	10 W			EAN 4000870 798751	<b>798.75</b>

**tunable white = 2.700 - 6.500 K**



**Set**



$\leftrightarrow$ 1,5 m	<u>max.</u> 6 m	405 lm	5,5 W	incl.		EAN 4000870 798768	<b>798.76</b>
$\leftrightarrow$ 3 m	<u>max.</u> 6 m	810 lm	11 W	incl.		EAN 4000870 798775	<b>798.77</b>

**Strip**



$\leftrightarrow$ 1 m		270 lm	4 W			EAN 4000870 798782	<b>798.78</b>
$\leftrightarrow$ 2,5 m		675 lm	9 W			EAN 4000870 798799	<b>798.79</b>

**RGBW – W = 3.000 K**



**Set**



$\leftrightarrow$ 1,5 m	<u>max.</u> 3 m	405 lm	10 W	incl.		EAN 4000870 798805	<b>798.80</b>
$\leftrightarrow$ 3 m	<u>max.</u> 5 m	810 lm	20 W	incl.		EAN 4000870 798812	<b>798.81</b>

**Strip**



$\leftrightarrow$ 1 m		270 lm	7 W			EAN 4000870 798829	<b>798.82</b>
$\leftrightarrow$ 2,5 m		675 lm	17 W			EAN 4000870 798836	<b>798.83</b>



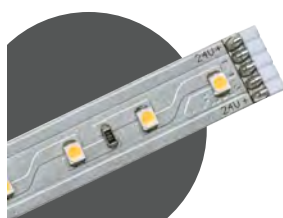

- Silver Metal
- Plateado Metal
- Argento Metallo

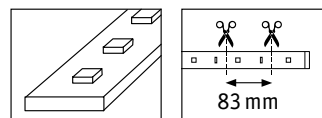

**MaxLED 500** 550 lm/m 72 LED/m  $\updownarrow$  3 mm  $\nearrow$  12,5 mm 230/24V

**warm white = 2.700 K**

**Set**



$\updownarrow$ 1,5 m	<u>max.</u> 3 m	825 lm	9 W	incl.  20 VA		EAN 4000870 705773	<b>705.77</b>
$\updownarrow$ 3 m	<u>max.</u> 5,5 m	1,650 lm	18 W	incl.  36 VA		EAN 4000870 705797	<b>705.79</b>
$\updownarrow$ 5 m	<u>max.</u> 16,5 m	2,750 lm	30 W	incl.  75 VA		EAN 4000870 706046	<b>706.04</b>
$\updownarrow$ 10 m	<u>max.</u> 20 m	5,500 lm	50 W	incl.  80 VA		EAN 4000870 708293	<b>708.29</b>

**Strip**



$\updownarrow$ 1 m		550 lm	6 W			EAN 4000870 705810	<b>705.81</b>
$\updownarrow$ 2,5 m		1,375 lm	15 W			EAN 4000870 708279	<b>708.27</b>

**daylight = 6.500 K**

**Set**



$\updownarrow$ 1,5 m	<u>max.</u> 3,5 m	825 lm	9 W	incl.  20 VA		EAN 4000870 705780	<b>705.78</b>
$\updownarrow$ 3 m	<u>max.</u> 6,5 m	1,650 lm	18 W	incl.  36 VA		EAN 4000870 705803	<b>705.80</b>
$\updownarrow$ 5 m	<u>max.</u> 13 m	2,750 lm	30 W	incl.  60 VA		EAN 4000870 706053	<b>706.05</b>
$\updownarrow$ 10 m	<u>max.</u> 20 m	5,500 lm	50 W	incl.  75 VA		EAN 4000870 708309	<b>708.30</b>

**Strip**



$\updownarrow$ 1 m		550 lm	6 W			EAN 4000870 705827	<b>705.82</b>
$\updownarrow$ 2,5 m		1,375 lm	15 W			EAN 4000870 708286	<b>708.28</b>

**warm white = 2.700 K**

**Bluetooth Set**



$\updownarrow$ 10 m	<u>max.</u> 20 m	5.500 lm	50 W	incl.  80 VA		EAN 4000870 709078	<b>709.07</b>
---------------------	------------------	----------	------	--------------	--	--------------------	---------------

**daylight = 6.500 K**

**Bluetooth Set**



$\updownarrow$ 10 m	<u>max.</u> 20 m	5.500 lm	50 W	incl.  75 VA		EAN 4000870 709085	<b>709.08</b>
---------------------	------------------	----------	------	--------------	--	--------------------	---------------



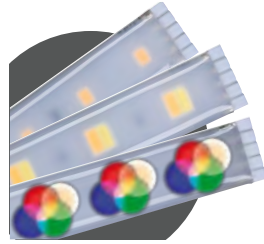

Silver Plastic  
 Plateado Plástico  
 Argento Plastica

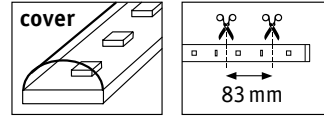

**MaxLED 500** 550 lm/m 60/72 LED/m  $\updownarrow$  4 mm  $\nearrow$  12,5 mm 230/24V

warm white = 2.700 K

**Set**



$\leftrightarrow$ 1,5 m	<u>max.</u> 3 m	825 lm	9 W	incl.  20 VA	EAN 4000870 706688 <b>706.68</b>
$\leftrightarrow$ 3 m	<u>max.</u> 5,5 m	1.650 lm	18 W	incl.  36 VA	EAN 4000870 706664 <b>706.66</b>



**Strip**



$\leftrightarrow$ 1 m		550 lm	6 W		EAN 4000870 706633 <b>706.63</b>
$\leftrightarrow$ 2,5 m		1.375 lm	15 W		EAN 4000870 705490 <b>705.49</b> <b>new</b>

daylight = 6.500 K

**Set**



$\leftrightarrow$ 1,5 m	<u>max.</u> 3,5 m	825 lm	9 W	incl.  20 VA	EAN 4000870 706671 <b>706.67</b>
$\leftrightarrow$ 3 m	<u>max.</u> 6,5 m	1.650 lm	18 W	incl.  36 VA	EAN 4000870 706657 <b>706.65</b>



**Strip**



$\leftrightarrow$ 1 m		550 lm	6 W		EAN 4000870 706640 <b>706.64</b>
$\leftrightarrow$ 2,5 m		1.375 lm	15 W		EAN 4000870 705483 <b>705.48</b> <b>new</b>

tunable white = 3.000 - 6.500 K

**Set**



$\leftrightarrow$ 1,5 m	<u>max.</u> 3 m	825 lm	10 W	incl.  20 VA	EAN 4000870 706237 <b>706.23</b>
$\leftrightarrow$ 3 m	<u>max.</u> 5 m	1.650 lm	20 W	incl.  36 VA	EAN 4000870 706244 <b>706.24</b>



**Strip**



$\leftrightarrow$ 1 m		550 lm	7 W		EAN 4000870 706305 <b>706.30</b>
$\leftrightarrow$ 2,5 m		1.375 lm	16 W		EAN 4000870 705506 <b>705.50</b> <b>new</b>

RGBW – W = 3.000 K

**Set**



$\leftrightarrow$ 1,5 m	<u>max.</u> 3 m	750 lm	18 W	incl.  36 VA	EAN 4000870 706275 <b>706.27</b>
$\leftrightarrow$ 3 m	<u>max.</u> 6 m	1.500 lm	36 W	incl.  60 VA	EAN 4000870 706282 <b>706.28</b>



**Strip**



$\leftrightarrow$ 1 m		500 lm	12 W		EAN 4000870 706343 <b>706.34</b>
$\leftrightarrow$ 2,5 m		1.250 lm	30 W		EAN 4000870 705513 <b>705.51</b> <b>new</b>





- |  |  |   |
|--|--|---|
| <ul style="list-style-type: none"> <li>▶ Self-adhesive LED strips for under-cabinet lighting</li> <li>▶ High-quality adhesive ensures long-term adhesion</li> <li>▶ Coating protects against splash water (IP44)</li> <li>▶ Suitable for all standard kitchen dimensions</li> <li>▶ Incl. touch switch for dimming and switching</li> <li>▶ Cables for bridging gaps (e.g. extractor hood) included</li> </ul> | <ul style="list-style-type: none"> <li>▶ Strips LED autoadhesivos para la iluminación debajo de armarios</li> <li>▶ El adhesivo de alta calidad asegura una sujeción duradera</li> <li>▶ El recubrimiento protege de salpicaduras de agua (IP44)</li> <li>▶ Apto para todas las medidas estándar en la cocina</li> <li>▶ Incluye interruptor táctil para la regulación y conmutación</li> <li>▶ Incl. cables para superar distancias (p. ej., extractor de humos)</li> </ul> | <ul style="list-style-type: none"> <li>▶ Strips LED autoadesive per l'illuminazione di sottopensili</li> <li>▶ Il pregiato adesivo garantisce una lunga tenuta</li> <li>▶ Il rivestimento protegge da spruzzi d'acqua (IP44)</li> <li>▶ Adatto per tutte le misure di cucina standard</li> <li>▶ Incl. Interruttore touch per regolazione intensità e commutazione</li> <li>▶ Incl. cavi per superare le distanze (ad es. cappa)</li> </ul> |
|--|--|---|



👉 Silver  Plastic  
👉 Plateado  Plástico  
👉 Argento  Plastica

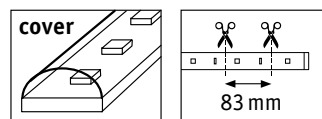

**MaxLED 500 Comfort Set Kitchen Touch Sensor**      550 lm/m      72 LED/m      ⇄ 3 mm ⇄ 12,5 mm      230/24 V

● warm white = 2.700 K



**Set**

⇄ **1,8 m**    max. 2,8 m    |    3×310 lm    |    3,1 W    |    incl. 20 VA       EAN 4000870 798386    **798.38**





- Silver Metal
- Plateado Metal
- Argento Metallo

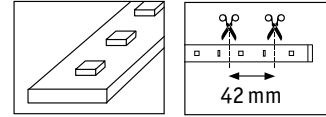

**MaxLED 1000** 1100 lm/m 144 LED/m  $\updownarrow$  3 mm  $\nearrow$  12,5 mm 230/24 V

warm white = 2.700 K



**Set**

$\updownarrow$ 1,5 m	<u>max.</u> 5 m	1,650 lm	18 W	incl.  60 VA	EAN 4000870 705858 <b>705.85</b>
$\updownarrow$ 3 m	<u>max.</u> 7 m	3,300 lm	35 W	incl.  75 VA	EAN 4000870 705889 <b>705.88</b>

**Strip**



$\updownarrow$ 1 m	1,100 lm	12 W	EAN 4000870 705681 <b>705.68</b>
$\updownarrow$ 2,5 m	2.750 lm	32 W	EAN 4000870 798140 <b>798.14</b>

daylight = 6.500 K



**Set**

$\updownarrow$ 1,5 m	<u>max.</u> 3 m	1,650 lm	18 W	incl.  36 VA	EAN 4000870 705865 <b>705.86</b>
$\updownarrow$ 3 m	<u>max.</u> 5,5 m	3,300 lm	35 W	incl.  60 VA	EAN 4000870 705896 <b>705.89</b>

**Strip**



$\updownarrow$ 1 m	1,100 lm	12 W	EAN 4000870 705698 <b>705.69</b>
--------------------	----------	------	----------------------------------



- Silver Plastic
- Plateado Plástico
- Argento Plastica

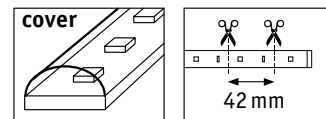

**MaxLED 1000** 1100 lm/m 144 LED/m  $\updownarrow$  4 mm  $\nearrow$  12,5 mm 230/24 V

warm white = 2.700 K



**Set**

$\updownarrow$ 1,5 m	<u>max.</u> 5 m	1.650 lm	18 W	incl.  60 VA	EAN 4000870 706725 <b>706.72</b>
$\updownarrow$ 3 m	<u>max.</u> 7 m	3.300 lm	35 W	incl.  75 VA	EAN 4000870 706701 <b>706.70</b>

**Strip**



$\updownarrow$ 1 m	1.100 lm	12 W	EAN 4000870 706763 <b>706.76</b>
--------------------	----------	------	----------------------------------

daylight = 6.500 K



**Set**

$\updownarrow$ 1,5 m	<u>max.</u> 3 m	1.650 lm	18 W	incl.  36 VA	EAN 4000870 706718 <b>706.71</b>
$\updownarrow$ 3 m	<u>max.</u> 5,5 m	3.300 lm	35 W	incl.  60 VA	EAN 4000870 706695 <b>706.69</b>

**Strip**



$\updownarrow$ 1 m	1.100 lm	12 W	EAN 4000870 706756 <b>706.75</b>
--------------------	----------	------	----------------------------------





## MaxLED Flow

- ▶ MaxLED Flow – get out of the shadows and into the lime light
- ▶ No LEDs to see, even when turned off: The strip can be placed out in the open on your walls or furniture
- ▶ The slender 1x1cm dimensions suit any furnishing style
- ▶ Incl. transparent clip holder, screws and wall anchors. The strip can be installed straight or in creative patterns to create illuminating wall decorations.
- ▶ The light effect on the wall is particularly striking as the strip has a beam angle of 180 degrees
- ▶ Can be combined with all MaxLED accessory components like connectors (RGB and Warm White) and controllers (Warm white)
- ▶ MaxLED Flow - basta de esconderse: ¡salimos al escenario!
- ▶ Incluso en estado apagado no se pueden ver los LED: El Strip se puede posicionar de manera abierta en la pared, en elementos de equipamiento o en muebles
- ▶ Las dimensiones delicadas de 1x1 cm se adaptan a cualquier estilo de decoración
- ▶ Incluye fijaciones por presilla, tornillos y tacos. El Strip se puede instalar en línea recta. Para una solución más creativa, también es posible curvar el strip de manera flexible, por ejemplo como adorno luminoso en la pared.
- ▶ El efecto lumínico en la pared es especialmente llamativo, dado que el Strip posee un ángulo de irradiación de 180° grados
- ▶ Se puede combinar con todos los accesorios MaxLED, tales como conectores (RGB y Blanco cálido) y controles (Blanco cálido)
- ▶ MaxLED Flow - basta stare in ombra, ecco le luci della ribalta
- ▶ Anche quando sono spente, il LED non è visibile: la Strip può essere posizionata in un'area visibile della parete o su mobili
- ▶ La misura filigranata di 1x1cm è perfetta per ogni stile di arredamento
- ▶ Include supporti a clip trasparenti, viti e tasselli. La Strip può essere posata perfettamente in rettilineo. Chi preferisce una soluzione più creativa può anche posare la Strip creando curve sinuose, ad es. per ottenere ornamento luminoso della parete.
- ▶ L'effetto luminoso sulla parete è particolarmente suggestivo, perché la Strip ha un angolo emissione di 180° gradi
- ▶ Può essere combinato con tutti gli accessori MaxLED, quali connettori (RGB e Bianco caldo) e sistemi di comando (Bianco caldo).





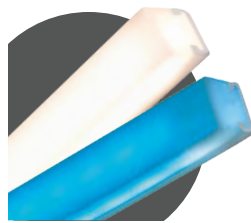
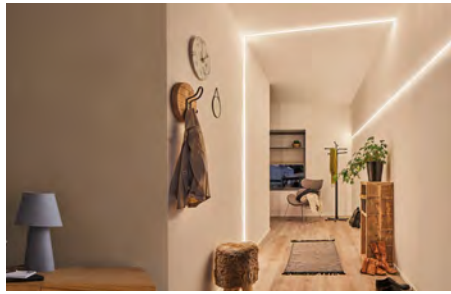

White Plastic  
 Blanco Plástico  
 Bianco Plastica



**MaxLED Flow**

230/24V

warm white = 2.700 K

- ▶ Basic lighting: 1000 lm/m & 180 LED/m
- ▶ Can be combined with all MaxLED controllers (Warm white)
- ▶ Luz de fondo: 1000 lm/m y 180 LED/m
- ▶ Se puede combinar con todos los controles (Blanco cálido) MaxLED.
- ▶ Illuminazione generale: 1000 lm/m e 180 LED/m
- ▶ Può essere combinato con tutti gli sistemi di comando (Bianco caldo) MaxLED.

**Set**



↔ 1,5 m		1.500 lm		21 W		incl. 24 VA		EAN 4000870 709627	<b>709.62</b>
↔ 3 m		3.000 lm		37 W		incl. 50 VA		EAN 4000870 709634	<b>709.63</b>
↔ 5 m		5.000 lm		52 W		incl. 75 VA		EAN 4000870 709641	<b>709.64</b>

RGB

- ▶ The RGB set comes with a high-quality remote control complete with wall mounting bracket
- ▶ El juego RGB incluye un control remoto de alta calidad con soporte de pared para el mando a distancia
- ▶ Il set RGB comprende un pregiato radiocomando incluso supporto a parete per il telecomando



**Set**



↔ 1,5 m		600 lm		13,5 W		incl. 24 VA		EAN 4000870 709658	<b>709.65</b>
↔ 3 m		1.200 lm		27 W		incl. 36 VA		EAN 4000870 709665	<b>709.66</b>
↔ 5 m		2.000 lm		43 W		incl. 75 VA		EAN 4000870 709672	<b>709.67</b>



White Plastic  
 Blanco Plástico  
 Bianco Plastica



**Flex-Connector 10cm**

6 ⇔ 100 ↗ 15 mm  
 EAN 4000870 705766  
**705.76**



**Flex-Connector 1m**

6 mm ↗ 15 mm ⇔ 1 m  
 EAN 4000870 705759  
**705.75**



**Flex-Connector 5m**

6 mm ↗ 15 mm ⇔ 5 m  
 EAN 4000870 705742  
**705.74**

- ▶ The MaxLED splitter splits the strip system into 2 strands.
- ▶ The Y-piece has a 10cm-wide input and an output of 2x 20cm strips.
- ▶ A total of 30cm of cables is perfect for a central feed-in, e.g. into a profile system.
- ▶ Branches can also easily be laid, e.g. when backlighting a piece of furniture or a TV wall.

- ▶ El divisor MaxLED divide el sistema de Strips en 2 tramos.
- ▶ La pieza en Y tiene Strips de 10 cm a la entrada y 2 Strips de 20 cm a la salida.
- ▶ El cable con una longitud total de 30 cm se puede utilizar perfectamente para la alimentación central, p. ej., en un sistema de perfiles.
- ▶ Además, resulta muy fácil instalar derivaciones, p. ej., para la iluminación posterior de un mueble o un televisor en la pared.

- ▶ MaxLED Splitter suddivide il sistema di Strip in 2 tratti.
- ▶ Il pezzo a Y presenta sull'ingresso 10cm e sull'uscita 2x 20cm di Strip.
- ▶ I 30 cm complessivi di cavi possono essere utilizzati in modo straordinario per l'alimentazione centrale, ad es. in un sistema di profili.
- ▶ Inoltre, la posa di diramazioni è semplicissima, ad es. per la retroilluminazione di un mobile o di una parete TV.



**MaxLED Y Splitter 30cm**

max. 144 W  
 7 ⇔ 30 ↗ 12 mm  
 EAN 4000870 798133  
**798.13**

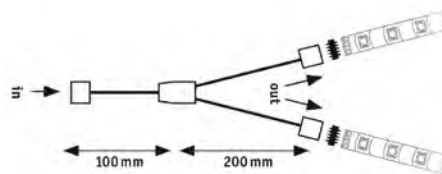

**MaxLED Edge-Connector**

max. 144 W  
 12 ⇔ 17 ↗ 16 mm  
 EAN 4000870 706152  
**706.15**

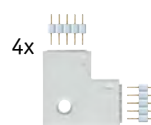

**MaxLED Edge-Connector 90°**

max. 144 W  
 4,5 ⇔ 25 ↗ 25 mm  
 EAN 4000870 706169  
**706.16**



**MaxLED X-Connector**

max. 144 W  
 6 ⇔ 32 ↗ 28 mm  
 EAN 4000870 706176  
**706.17**



**MaxLED Clip-to-Clip Connector**

max. 144 W  
 4,5 ⇔ 20 ↗ 13,5 mm  
 EAN 4000870 706183  
**706.18**



**Universal MaxLED Connector**

max. 144 W  
 7 ⇔ 100 ↗ 19 mm  
 EAN 4000870 709191  
**709.19**



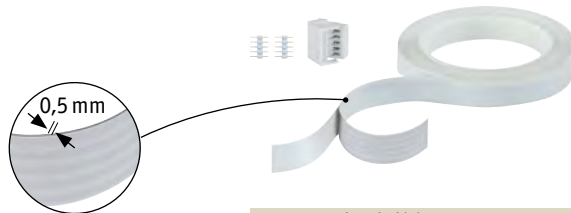

**MaxLED invisible connector**

max. 144/96 W  
 24 V  
 ⚡12 mm ↔17,5 mm ↗0,5 mm ↔3 m  
 EAN 4000870 798287  
**798.28**

White Plastic  
 Blanco Plástico  
 Bianco Plastica



**MaxLED invisible connector**

max. 144/96 W  
 24 V  
 ⚡12 mm ↔17,5 mm ↗0,5 mm ↔5 m  
 EAN 4000870 798294  
**798.29**

White Plastic  
 Blanco Plástico  
 Bianco Plastica

**Power Supply 24V DC**



- ▶ Energy-efficient electronic ballast with long service life
- ▶ Simple plug-in system for easy installation
- ▶ Incl. 1.5 m primary supply line with Europlug & 1 m secondary supply line
- ▶ Incl. 5-pin plug for easy interlinking of the strips

- ▶ Reactancia electrónica de bajo consumo y de larga duración
- ▶ Sistema de encaje sencillo para el montaje sin problemas
- ▶ Incluye 1,5 m cable de alimentación primario con enchufe Euro y 1 m de cable secundario
- ▶ Incluye conector de 5 clavijas para la conexión sencilla de los Strips

- ▶ Alimentatore elettronico a efficienza energetica, con lunga vita utile
- ▶ Semplice sistema di collegamento per un agevole montaggio
- ▶ Include 1,5 m di linea di alimentazione primaria con spina Euro e 1 m di linea di alimentazione secondaria
- ▶ Include spina a 5 poli per un semplice collegamento delle Strips



**Universal LED Power Supply 12W 24V DC**

max. 12 W  
 230/24 V, incl. ⚡12 VA  
 ⚡63 ↔40 ↗26 mm  
 EAN 4000870 798355  
**798.35**



**Universal LED Power Supply 36W 24V DC**

max. 36 W  
 230/24 V, incl. ⚡36 VA  
 ⚡101 ↔51 ↗31 mm  
 EAN 4000870 798379  
**798.37**

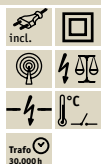

**Power Supply 24V DC**

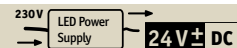

- ▶ Energy-efficient electronic ballast with long service life
- ▶ Simple plug-in system for easy installation
- ▶ Incl. 1.5 m primary supply line with Europlug & 1 m secondary supply line
- ▶ Incl. 5-pin plug for easy interlinking of the strips
- ▶ Reactancia electrónica de bajo consumo y de larga duración
- ▶ Sistema de encaje sencillo para el montaje sin problemas
- ▶ Incluye 1,5 m cable de alimentación primario con enchufe Euro y 1 m de cable secundario
- ▶ Incluye conector de 5 clavijas para la conexión sencilla de los Strips
- ▶ Alimentatore elettronico a efficienza energetica, con lunga vita utile
- ▶ Semplice sistema di collegamento per un agevole montaggio
- ▶ Include 1,5 m di linea di alimentazione primaria con spina Euro e 1 m di linea di alimentazione secondaria
- ▶ Include spina a 5 poli per un semplice collegamento delle Strips



**Power Supply 24V DC**

max. 40 W  
230/24 V, incl. 40 VA  
24 ⇄ 52 166 mm  
EAN 4000870 798317  
**798.31**



- 🌀 White Plastic
- 🌀 Blanco Plástico
- 🌀 Bianco Plastica

**Power Supply 24V DC**

max. 60 W  
230/24 V, incl. 60 VA  
32 ⇄ 61 184 mm  
EAN 4000870 798300  
**798.30**



- 🌀 White Plastic
- 🌀 Blanco Plástico
- 🌀 Bianco Plastica

**Power Supply 24V DC**

max. 150 W  
230/24 V, incl. 150 VA  
34 ⇄ 210 167 mm  
EAN 4000870 709764  
**709.76**



- 🌀 White Plastic
- 🌀 Blanco Plástico
- 🌀 Bianco Plastica

Maximum length of your system	40W		60W		150W	
	→	↔*	→	↔*	→	↔*
<b>MaxLED 250</b> Warm white, Daylight, Tunable White	<b>11 m</b>	<b>10 m</b> (5 m + 5 m)	<b>17 m</b>	<b>16 m</b> (8 m + 8 m)	<b>30 m</b>	<b>40 m</b> (20 m + 20 m)
<b>MaxLED 250</b> RGBW	<b>6,5 m</b>	<b>6 m</b> (3 m + 3 m)	<b>10 m</b>	<b>9 m</b> (4,5 m + 4,5 m)	<b>20 m</b>	<b>22 m</b> (11 m + 11 m)
<b>MaxLED 500</b> Warm white	<b>6,5 m</b>	<b>6 m</b> (3 m + 3 m)	<b>10 m</b>	<b>9 m</b> (4,5 m + 4,5 m)	<b>20 m</b>	<b>22 m</b> (11 m + 11 m)
<b>MaxLED 500</b> Daylight	<b>7 m</b>	<b>6 m</b> (3 m + 3 m)	<b>13 m</b>	<b>11 m</b> (5,5 m + 5,5 m)	<b>24 m</b>	<b>26 m</b> (13 m + 13 m)
<b>MaxLED 500</b> Tunable White	<b>6,5 m</b>	<b>6 m</b> (3 m + 3 m)	<b>10 m</b>	<b>9 m</b> (4,5 m + 4,5 m)	<b>20 m</b>	<b>22 m</b> (11 m + 11 m)
<b>MaxLED 500</b> RGBW	<b>3,5 m</b>	<b>3 m</b> (1,5 m + 1,5 m)	<b>6 m</b>	<b>5 m</b> (2,5 m + 2,5 m)	<b>10 m</b>	<b>16 m</b> (8 m + 8 m)
<b>MaxLED 1000</b> Warm white	<b>3 m</b>	<b>2 m</b> (1 m + 1 m)	<b>5 m</b>	<b>4 m</b> (2 m + 2 m)	<b>10 m</b>	<b>12 m</b> (6 m + 6 m)
<b>MaxLED 1000</b> Daylight	<b>3,5 m</b>	<b>3 m</b> (1,5 m + 1,5 m)	<b>5,5 m</b>	<b>4 m</b> (2 m + 2 m)	<b>10 m</b>	<b>15 m</b> (7,5 m + 7,5 m)

\*use with 798.13 Y-Splitter or 706.17 X-Connector

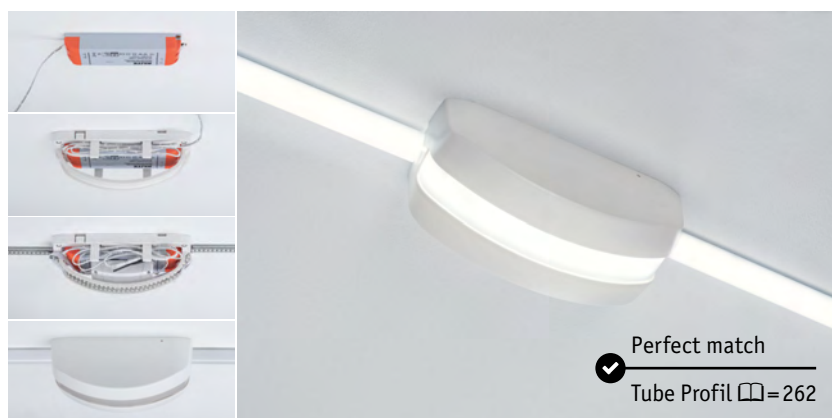
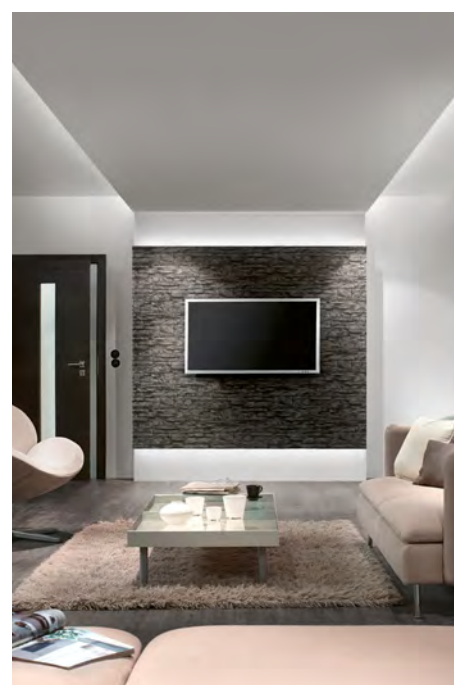

**Shining Case**

90 ⇄ 220 92 mm  
EAN 4000870 705162  
**705.16**

- 🌀 Matt white Plastic
- 🌀 Blanco mate Plástico
- 🌀 Bianco opaco Plastica





- 🔗 White 📦 Plastic
- 🔗 Blanco 📦 Plástico
- 🔗 Bianco 📦 Plastica

- ▶ Automatic on and off via motion sensor at night.
- ▶ Time adjustable from 30 sec. to 10 min.
- ▶ 100° detection angle
- ▶ Detection radius 0-5m
- ▶ Encendido y apagado automático de noche mediante detector de movimientos.
- ▶ Tiempo ajustable entre 30 seg. y mín. 10 min.
- ▶ Ángulo de detección 100°
- ▶ Radio de detección 0-5m
- ▶ Dispositivo automatico di accensione e spegnimento attraverso rilevatore di movimento per la notte.
- ▶ Tempo regolabile da 30 sec. a min 10 min.
- ▶ Angolo di rilevamento 100°
- ▶ Raggio di rilevamento 0-5m



**MaxLED Night PIR Sensor**  
max. 144W 24 V

max. 144 W  
DC 24 V  
⌀33 ⇄48 ⚙35 mm  
EAN 4000870 709740  
**709.74** 📦

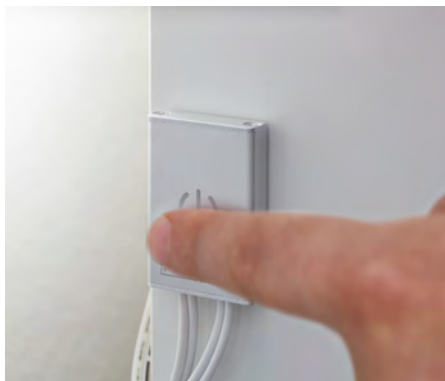

- 🔗 Silver 📦 Metal
- 🔗 Plateado 📦 Metal
- 🔗 Argento 📦 Metallo

- ▶ Switches on/off when touched. Press and hold to dim.
- ▶ Incl. memory effect
- ▶ Incl. adhesive pads
- ▶ Encendido/apagado con una pulsación breve. Regulación con una pulsación prolongada.
- ▶ Con efecto memoria
- ▶ Incluye almohadillas adhesivas
- ▶ Per accenderla o spegnerla basta sfiorarla. Per dimmerare, premere più a lungo.
- ▶ Incluso Memory Effekt
- ▶ Cuscinetti adesivi inclusi



**MaxLED Touch Switch**  
max. 144W 24 V

max. 144 W  
DC 24 V  
⌀8,5 ⇄43 ⚙30 mm  
EAN 4000870 709757  
**709.75** 📦

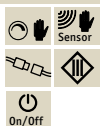

- ▶ Sensors in miniature format for single-colour LED strips – perfect for profiles\*
- ▶ Sensores en formato miniatura para Strips LED de un solo color, perfectos para perfiles\*
- ▶ Sensori nel formato più piccolo per Strip LED monocromatiche, si adattano perfettamente ai profili\*

- ▶ Proximity switch (<5 cm) for contactless control
- ▶ Interruptor de proximidad (<5 cm) para el control sin contacto
- ▶ Interruttore di prossimità (<5 cm) per il controllo senza contatto



**MaxLED Touchless Sensor**  
 max. 144 W  
 DC 24 V  
 ⌀7 ⇄56,5 ↗12,5 mm  
 EAN 4000870 798409  
**798.40**



  
 Touchless 3-5cm  
 <0,5 s = ⏻ On/Off  
 >0,5 s = ⏻ dim  
 incl. memory function



\*Delta Profil, Duo Profil, Square Profil, Tube Profil, Step Profil, Floor Profil □=254-262

- ▶ Motion sensor for contactless control
- ▶ Detector de movimientos para el control sin contacto
- ▶ Rilevatore di movimento per il controllo senza contatto



**MaxLED Night PIR Sensor**  
 max. 144 W  
 DC 24 V  
 ⌀16 ⇄56,5 ↗12,5 mm  
 EAN 4000870 798416  
**798.41**

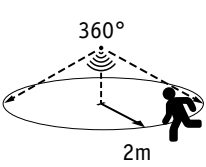

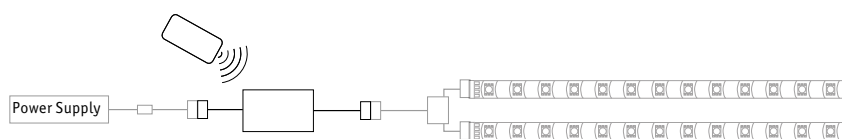

  
 360°  
 2m  
 Softstart  
 0-100% = 2s

\*Delta Profil, Duo Profil, Square Profil, Tube Profil, Step Profil □=254-262





- ↳ White □ Plastic
- ↳ Blanco □ Plástico
- ↳ Bianco □ Plastica



- ▶ For switching or dimming individual MaxLED strips
- ▶ IR Controller: Line of sight to the receiver required
- ▶ RF controller 2.4 GHz: No line of sight to the receiver needed, perfect for concealed installations
- ▶ Para la conmutación o regulación de MaxLED Strips individuales
- ▶ Controller IR: requiere contacto visual con el receptor
- ▶ Controller por radio 2,4 GHz: no requiere contacto visual con el receptor, perfecto para una instalación oculta
- ▶ Per commutare o dimmerare singole strisce MaxLED
- ▶ Controller a infrarossi: È necessario un contatto visivo con il ricevitore
- ▶ Controller radio 2,4 GHz: Non è necessario un contatto visivo con il ricevitore, perfetto per l'installazione non a vista



**Dimm/Switch Controller IR**  
 max. 144 W  
 1xCR 2025/3V  
 DC 24 V  
 ⌀22 ⇄50 ↗35 mm  
 EAN 4000870 706831  
**706.83**





**Dimm/Switch-Controller 2.4GHz**  
 max. 144 W  
 2xAAA/1,5V (Micro)  
 DC 24 V  
 ⌀22,5 ⇄85 ↗45 mm  
 EAN 4000870 706190  
**706.19**

**RGBW-Controller 2.4GHz**  
 max. 144 W  
 2xAAA/1,5V (Micro)  
 DC 24 V  
 ⌀20 ⇄110 ↗53 mm  
 EAN 4000870 797976  
**797.97**

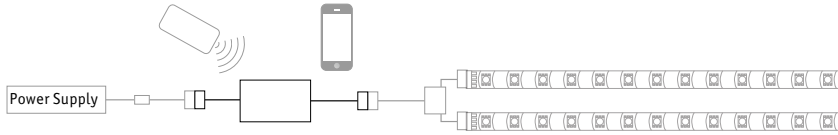

- 🔌 White 📦 Plástico
- 🔌 Blanco 📦 Plástico
- 🔌 Bianco 📦 Plastica

smart  
controllable  
**Bluetooth®**



**Switch/Dimm Controller**

max. 144 W  
DC 24 V  
⏏️19 ⏏️39 ⏏️80 mm  
EAN 4000870 500026  
**500.02** 📦



**Tunable White Controller**

max. 144 W  
DC 24 V  
⏏️19 ⏏️39 ⏏️80 mm  
EAN 4000870 500033  
**500.03** 📦



**RGBW Controller**

max. 144 W  
DC 24 V  
⏏️19 ⏏️39 ⏏️80 mm  
EAN 4000870 500040  
**500.04** 📦



- 🔌 White/Grey 📦 Plástico
- 🔌 Blanco/Gris 📦 Plástico
- 🔌 Bianco/Grigio 📦 Plastica

smart  
controllable  
**zigbee**



**Switch/Dimm Controller**

max. 144 W  
DC 24 V  
⏏️28 ⏏️38 ⏏️95 mm  
EAN 4000870 500453  
**500.45** 📦

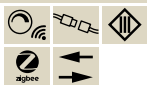

**Tunable White Controller**

max. 144 W  
DC 24 V  
⏏️28 ⏏️38 ⏏️95 mm  
EAN 4000870 500460  
**500.46** 📦



**RGBW Controller**

max. 144 W  
DC 24 V  
⏏️28 ⏏️38 ⏏️95 mm  
EAN 4000870 500477  
**500.47** 📦



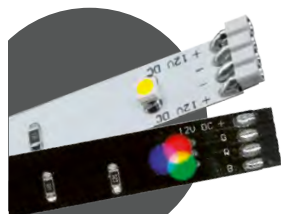

Metal  
 Metal  
 Metallo

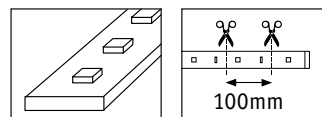

**YourLED ECO** 160 lm/m 30 LED/m  $\updownarrow$  3 mm  $\nearrow$  10 mm 230/12V

warm white = 3.000 K

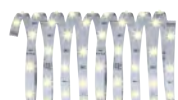

**Set**

$\leftrightarrow$  3 m  $\xrightarrow{\text{max.}}$  6 m | 480 lm | 6,8 W | incl. 12 VA EAN 4000870 704288 **704.28**



**Strip**

$\leftrightarrow$  1 m | 160 lm | 2,4 W EAN 4000870 704592 **704.59**  
 $\leftrightarrow$  3 m | 480 lm | 6,8 W EAN 4000870 702543 **702.54**  
 $\leftrightarrow$  5 m | 780 lm | 10,5 W EAN 4000870 702550 **702.55**

neutral white = 4.000 K



**Set**

$\leftrightarrow$  3 m  $\xrightarrow{\text{max.}}$  6 m | 540 lm | 6,8 W | incl. 12 VA EAN 4000870 704295 **704.29**



**Strip**

$\leftrightarrow$  1 m | 180 lm | 2,4 W EAN 4000870 704585 **704.58**  
 $\leftrightarrow$  3 m | 540 lm | 6,8 W EAN 4000870 702567 **702.56**  
 $\leftrightarrow$  5 m | 900 lm | 10,5 W EAN 4000870 702574 **702.57**

RGB



**Set**



$\leftrightarrow$  3 m  $\xrightarrow{\text{max.}}$  5 m | 330 lm | 14,5 W | incl. 24 VA EAN 4000870 704301 **704.30**



**Strip**

$\leftrightarrow$  3 m | 330 lm | 14,5 W EAN 4000870 702529 **702.52**  
 $\leftrightarrow$  5 m | 550 lm | 18 W EAN 4000870 702536 **702.53**  
 $\leftrightarrow$  1 m | 110 lm | 6 W EAN 4000870 704608 **704.60**





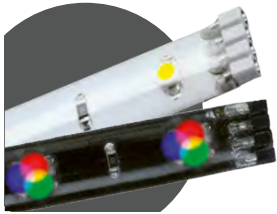
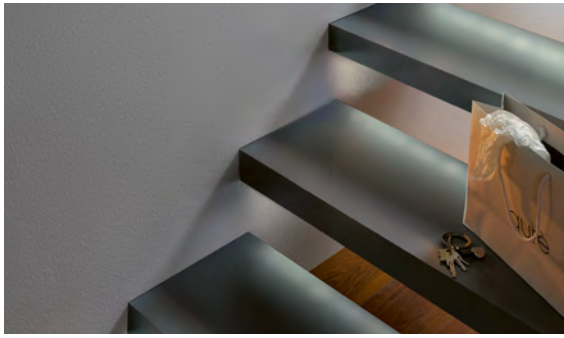

Plastic  
Plástico  
Plastica

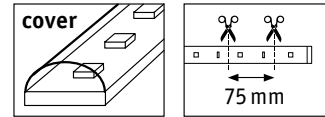

**YourLED** 265 lm/m 39 LED/m  $\updownarrow$  3 mm  $\nearrow$  10 mm 230/12V

**warm white = 3.000 K**



**Set**

$\leftrightarrow$ 1,5 m	$\leftarrow$ max. 4,8 m	400 lm	4,5 W	incl. $\square$ 12 VA		EAN 4000870 703175	<b>703.17</b>
$\leftrightarrow$ 3 m	$\leftarrow$ max. 7,5 m	800 lm	7,5 W	incl. $\square$ 18 VA		EAN 4000870 703205	<b>703.20</b>

**Strip**



$\leftrightarrow$ 0,97 m		265 lm	3 W			EAN 4000870 702086	<b>702.08</b>
$\leftrightarrow$ 3 m		800 lm	7,5 W			EAN 4000870 705926	<b>705.92</b>

**daylight = 6.000 K**



**Set**

$\leftrightarrow$ 1,5 m	$\leftarrow$ max. 4,8 m	405 lm	4,5 W	incl. $\square$ 12 VA		EAN 4000870 703182	<b>703.18</b>
$\leftrightarrow$ 3 m	$\leftarrow$ max. 7,5 m	810 lm	7,5 W	incl. $\square$ 18 VA		EAN 4000870 703212	<b>703.21</b>

**Strip**



$\leftrightarrow$ 0,97 m		270 lm	3 W			EAN 4000870 702093	<b>702.09</b>
$\leftrightarrow$ 3 m		810 lm	7,5 W			EAN 4000870 705933	<b>705.93</b>

**RGB**



**Set**



$\leftrightarrow$ 1,5 m	$\leftarrow$ max. 3 m	275 lm	10 W	incl. $\square$ 18 VA		EAN 4000870 703199	<b>703.19</b>
$\leftrightarrow$ 3 m	$\leftarrow$ max. 5 m	550 lm	17,8 W	incl. $\square$ 24 VA		EAN 4000870 703229	<b>703.22</b>

**Strip**



$\leftrightarrow$ 0,98 m		184 lm	7 W			EAN 4000870 702109	<b>702.10</b>
$\leftrightarrow$ 3 m		550 lm	17,8 W			EAN 4000870 705940	<b>705.94</b>





- 👉 White 📦 Plastic
- 👉 Blanco 📦 Plástico
- 👉 Bianco 📦 Plastica

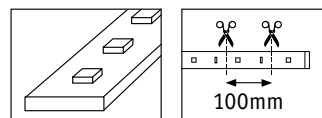

**YourLED Eco Comfort Set Touch**

230/12V



**YourLED Eco Comfort Set Touch**  
1m expanded max. 2m

incl. 1x2,4W  
3.000 K  
☞ 120°  
230/12V, incl. ⚡ 6 VA  
⏏ 3 mm ⏏ 10,5 mm ⏏ 1 m  
EAN 4000870 709542  
**709.54** 📦



- 👉 White 📦 Plastic
- 👉 Blanco 📦 Plástico
- 👉 Bianco 📦 Plastica

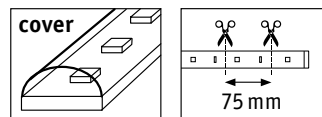

**YourLED Comfort Set Night**

230/12V



**YourLED Comfort Set Night**  
1m expanded max. 2m

incl. 1x3W  
273 lm, 3.000 K  
☞ 120°  
230/12V, incl. ⚡ 6 VA  
⏏ 3 mm ⏏ 975 mm ⏏ 10,5 mm ⏏ 1 m  
EAN 4000870 709559  
**709.55** 📦

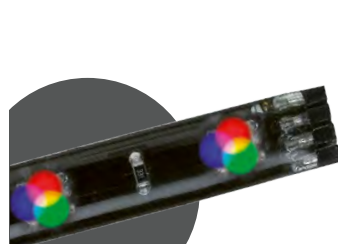

- 👉 Black 📦 Plastic
- 👉 Negro 📦 Plástico
- 👉 Nero 📦 Plastica

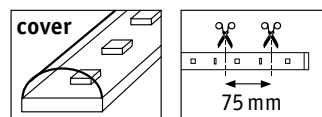

**YourLED Comfort Set Lights and Sound**

230/12V



**YourLED Comfort Set Lights and Sound**  
3m expanded max. 5m

incl. 1x17,8W  
☞ 120°  
1xCR 2025/3V  
230/12V, incl. ⚡ 18 VA  
⏏ 3 mm ⏏ 10,5 mm ⏏ 3 m  
EAN 4000870 709566  
**709.56** 📦





Plastic  
Plástico  
Plastica

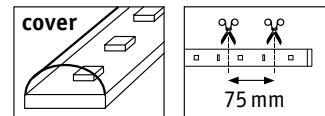

**YourLED IP44** 265 lm/m 39LED/m  $\updownarrow$  3 mm  $\nearrow$  10 mm 230/12V

warm white = 3.000 K



**Set**

$\leftrightarrow$  3 m  $\xrightarrow{\text{max.}}$  7,5 m | 800 lm | 7,5 W | incl.  $\text{⏻}$  18 VA  $\text{🔌}$  EAN 4000870 705100 **705.10**

for  
RGB Color  
 $\square$  = 230–231



- ▶ RGB Sound Sensor – registers sound and music to create dynamic lighting effects with YourLED RGB Strips – the perfect party lights
- ▶ Suitable for controlling coloured RGB strips
- ▶ Sensor de sonido RGB: registra sonidos y música y los convierte en impresiones lumínicas dinámicas en Strips RGB YourLED - fantástica luz Party
- ▶ Adecuado para el control de strips RGB de colores
- ▶ Sensore RGB-Sound - rileva suoni e musica e li trasforma in una esperienza luminosa dinamica con le Strip YourLED RGB; la straordinaria luce Party
- ▶ Per il controllo di Strips RGB colorate



Black Plastic  
 Negro Plástico  
 Nero Plastica

**RGB-Sound-Sensor**

max. 60 W  
1xCR 2025/3V  
DC 12 V  
 $\updownarrow$  22  $\leftrightarrow$  60  $\nearrow$  35 mm  
EAN 4000870 709177  
**709.17**



for  
RGB Color  
□ = 230–231

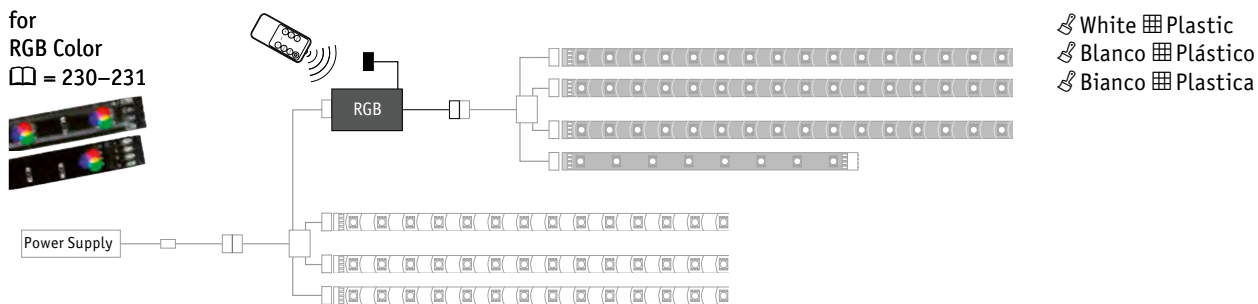

- 👉 White 🏠 Plastic
- 👉 Blanco 🏠 Plástico
- 👉 Bianco 🏠 Plastica

- ▶ Necessary for controlling YourLED and YourLED ECO RGB strips
- ▶ IR remote control with free selection of preset colours as well as for fine adjustment of the individual colour channels as needed. 4 programs (colour change, strobe,...)
- ▶ Continuously variable dimming
- ▶ Necesario para el control de tiras RGB YourLED y YourLED ECO
- ▶ Mando a distancia IR con elección libre de colores preajustados así como el ajuste fino de los canales de color individuales según se necesite. 4 programas (cambio de color, estroboscopio, ...)
- ▶ Regulación continua
- ▶ Necesario al pilotaggio delle strisce RGB YourLED e YourLED ECO
- ▶ Telecomando a infrarossi con selezione a piacere dei colori preimpostati e sintonia fine dei singoli canali cromatici in base alle necessità. 4 programmi (cambio di colore, stroboscopio, ecc.)
- ▶ Dimming in continuo



**RGB-Controller 12V DC**

max. 60 W  
1xCR 2025/3V  
DC 12 V  
∅22 ⇄60 ⇄35 mm  
EAN 4000870 702024  
**702.02** 📡



for  
RGB Color  
□ = 230–231

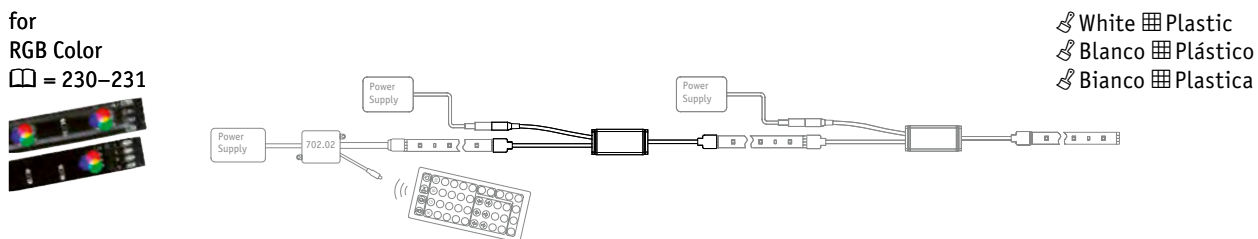

- 👉 White 🏠 Plastic
- 👉 Blanco 🏠 Plástico
- 👉 Bianco 🏠 Plastica

- ▶ Amplifying the control signal from the type 702.02 YourLED controller.
- ▶ This is how to use a remote control to synchronously control larger YourLED or YourLED ECO RGB strip systems.
- ▶ An additional power supply unit is attached to each amplifier to increase the power of the system
- ▶ Para amplificar la señal de control de la controladora RGB YourLED (Art. N° 702.02).
- ▶ Así pueden controlarse con un mando a distancia mayores sistemas RGB-Stripe YourLED o YourLED ECO sincronizadamente.
- ▶ Mediante cada amplificador se conecta una fuente de alimentación adicional, para ampliar la potencia del sistema
- ▶ Per potenziare il segnale di comando del regolatore RGB YourLED Art. 702.02.
- ▶ Un telecomando permette di comandare sincronicamente grandi sistemi di strisce YourLED o YourLED ECO RGB.
- ▶ A ogni amplificatore viene collegata un'ulteriore fonte di alimentazione per implementare la potenza del sistema



**RGB Amplifier**

max. 60 W  
DC 12 V  
∅8 ⇄51 ⇄27 mm  
EAN 4000870 709122  
**709.12** 📡



for  
Strip  
□□ = 230–233

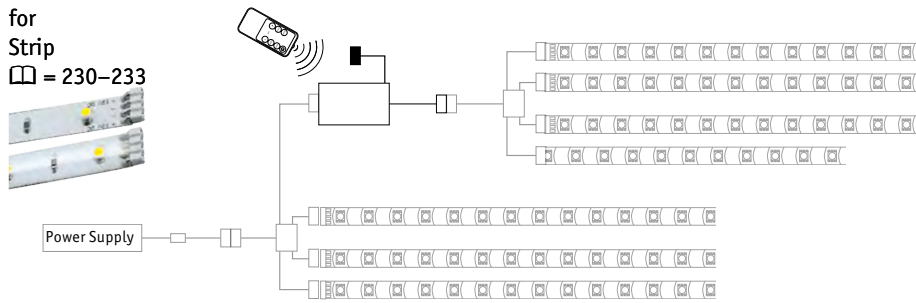

White Plastic  
Blanco Plástico  
Bianco Plastica

- ▶ For switching on or off or dimming the monochrome YourLED or YourLED ECO Strips
- ▶ The controller with remote control makes operation easy and provides a pleasant, dimmable mood light.
- ▶ Para conmutar o regular regletas monocolor de YourLED o YourLED ECO
- ▶ El mando a distancia ofrece confort y convence por su agradable luz regulable.
- ▶ Per commutare o regolare l'intensità delle strisce YourLED o YourLED ECO monocromatiche
- ▶ Il regolatore con comando remoto offre il comfort necessario e affascina con una piacevole luce d'atmosfera regolabile.



**Dimm/Switch Controller IR**

max. 60 W  
1xCR 2025/3V  
DC 12 V  
∅22 ↔63 ↗35 mm  
EAN 4000870 704615  
**704.61**



for  
Strip  
□□ = 230–233

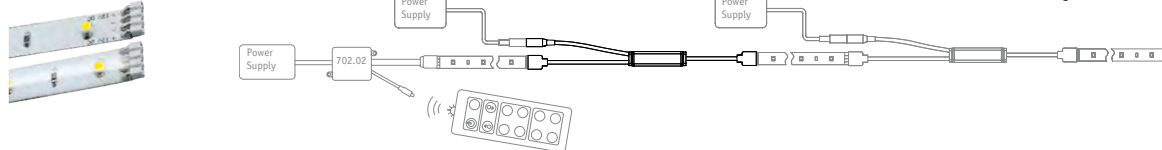

White Plastic  
Blanco Plástico  
Bianco Plastica

- ▶ Amplifying the control signal from the YourLED dimmer/controller type 704.61
- ▶ This is how to use a remote control to synchronously control larger monochrome YourLED or YourLED ECO Strip systems
- ▶ An additional power supply unit is attached to each amplifier to increase the power of the system
- ▶ Para amplificar la señal de control de la controladora/regulador de YourLED (Art. N° 704.61)
- ▶ Así pueden controlarse o regular con un mando a distancia mayores sistemas de regletas YourLED o YourLED ECO sincronizadamente
- ▶ Mediante cada amplificador se conecta una fuente de alimentación adicional, para ampliar la potencia del sistema
- ▶ Per potenziare il segnale di comando del regolatore/commutatore YourLED 704.61
- ▶ Un telecomando permette di comandare o regolare in maniera sincronizzata grandi sistemi di strisce YourLED o YourLED ECO monocromatiche
- ▶ A ogni amplificatore viene collegata un'ulteriore fonte di alimentazione per implementare la potenza del sistema



**Mono Color Amplifier**

max. 60 W  
DC 12 V  
∅8 ↔50 ↗15 mm  
EAN 4000870 709115  
**709.11**



Maximum total length of your system:	15W		48W		60W	
	→	→	↔	→	↔	
YourLED	5 m	10 m	20 m (10 m + 10 m)	12 m	24 m (12 m + 12 m)	
YourLED ECO	6 m	12,5 m	25 m (12,5 m + 12,5 m)	15 m	30 m (15 m + 15 m)	
YourLED RGB	2 m	4 m	8 m (4 m + 4 m)	5 m	10 m (5 m + 5 m)	
YourLED ECO RGB	2,5 m	6 m	12 m (6 m + 6 m)	8 m	16 m (8 m + 8 m)	

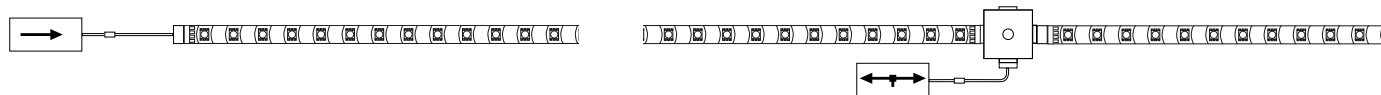

→ Maximum length for strips plugged in directly one after the other.

↔ The first value in parentheses below the total length specifies the maximum route length that can be connected directly to the transformer. For the full length, you also need a junction box or an X-connector to distribute the power. If further branches go off, the total length is reduced. Add up the individual watt values of the strips to determine the size of the transformer.

→ Máxima longitud para strips encajadas directamente de forma consecutiva.

↔ El primer valor que aparece entre paréntesis debajo de la longitud total indica el tramo máximo que se puede conectar directamente con el transformador. Para la longitud total, necesita adicionalmente una caja de empalmes o un conector X para distribuir la potencia. En caso de más derivaciones, la longitud total será más corta. Sume los distintos valores de vatios de las strips para determinar el tamaño del transformador.

→ Lunghezza massima per Strips inserite in successione diretta.

↔ Il primo valore tra parentesi sotto la lunghezza complessiva indica la lunghezza di percorso massima che è possibile collegare direttamente al trasformatore. Per l'intera lunghezza, servono inoltre un Junctionbox oppure un connettore a X per distribuire questa potenza. Con ulteriori diramazioni, la lunghezza totale si riduce. Per calcolare la misura del trasformatore, basta sommare le singole potenze delle Strips.



**Power Supply 230/12V DC**

max. 15 W  
230/12 V, incl. 15 VA  
18 ⇄ 40 125 mm  
EAN 4000870 701997  
**701.99**



- Grey/Black Plastic
- Gris/Negro Plástico
- Grigio/Nero Plastica



**Power Supply 230/12V DC**

max. 48 W  
230/12 V, incl. 48 VA  
40 ⇄ 55 135 mm  
EAN 4000870 702000  
**702.00**



- Grey/Black Plastic
- Gris/Negro Plástico
- Grigio/Nero Plastica



**Power Supply 60W 230/12V DC IP65**

max. 60 W  
230/12 V, incl. 60 VA  
40 ⇄ 60 225 mm  
EAN 4000870 702017  
**702.01**



- Grey/Black Plastic
- Gris/Negro Plástico
- Grigio/Nero Plastica





**Sensor** 10°  
50-10mm  
on/off

White Plastic  
Blanco Plástico  
Bianco Plastica

- ▶ Proximity switch for switching on and off the LED strips and other products
- ▶ Max. 75 W (magnetic transformers)
- ▶ Max. 60 W (electronic load)
- ▶ Max. 250 W (light bulbs)
- ▶ Interruptor de proximidad para encender/apagar regletas LED-stripes y otros productos
- ▶ Máx. 75 W (transformadores magnéticos)
- ▶ Máx. 60 W (carga electrónica)
- ▶ Máx. 250 W (lámparas incandescentes)
- ▶ L'interruttore di prossimità accende o spegne le strisce LED e altri prodotti
- ▶ Max. 75 W (trasformatori magnetici)
- ▶ Max. 60 W (carico elettronico)
- ▶ Max. 250 W (lampadine a incandescenza)



**PIR-Sensor 230V**

max. 60 W  
230V  
19 17,5 85 36 mm  
EAN 4000870 704516  
**704.51**



for Strip  
□ = 230-233

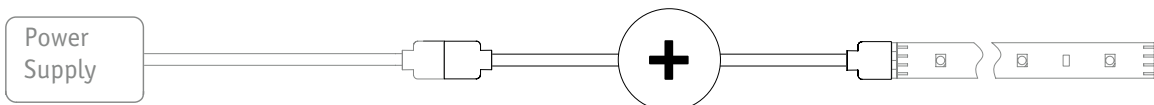

**Sensor** 120°  
0,5-5m  
5s-60s



White Plastic  
Blanco Plástico  
Bianco Plastica

**IR-Sensor**

max. 60 W  
DC 12V  
18 50 36 mm  
EAN 4000870 707265  
**707.26**

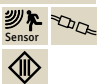

White Plastic  
Blanco Plástico  
Bianco Plastica

**On/Off Switch**

max. 60 W  
DC 12V  
15 60 26 mm  
EAN 4000870 707272  
**707.27**



- ▶ Switches on when dark and when motion is detected
- ▶ Light time adjustable from 30 sec. to 10 min.
- ▶ Max. 60W
- ▶ Suitable for controlling 3000K, 4000K, 6000K monochrome strips

- ▶ Se enciende en caso de movimientos y oscuridad
- ▶ Tiempo de encendido ajustables entre 30 seg. y mín. 10 min.
- ▶ Max. 60W
- ▶ Adecuado para el control de strips monocolor 3000 K, 4000 K, 6000 K

- ▶ Accensione in caso di movimento e oscurità
- ▶ Tempo di accensione regolabili da 30 sec. a min 10 min.
- ▶ Max. 60W
- ▶ Per il controllo di Strips monocrome 3000K, 4000K, 6000K



<10 Lux  
100°  
0-5m  
30 s-10 min



- 👉 Silver 📦 Plastic
- 👉 Plateado 📦 Plástico
- 👉 Argento 📦 Plastica

#### YourLED Night PIR Sensor

max. 60W  
DC 12V  
⌀31 ⇄48 ⚙36 mm  
EAN 4000870 709610  
**709.61** 📦



- ▶ Switches on when dark and when motion is detected
- ▶ Light time adjustable from 30 sec. to 10 min.
- ▶ Max. 60W
- ▶ Suitable for controlling 3000K, 4000K, 6000K monochrome strips

- ▶ Se enciende en caso de movimientos y oscuridad
- ▶ Tiempo de encendido ajustables entre 30 seg. y mín. 10 min.
- ▶ Max. 60W
- ▶ Adecuado para el control de strips monocolor 3000 K, 4000 K, 6000 K

- ▶ Accensione in caso di movimento e oscurità
- ▶ Tempo di accensione regolabili da 30 sec. a min 10 min.
- ▶ Max. 60W
- ▶ Per il controllo di Strips monocrome 3000K, 4000K, 6000K

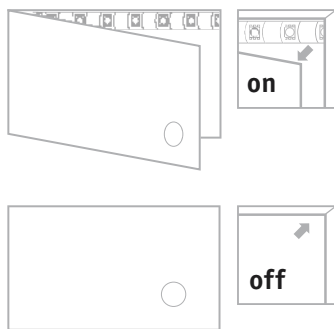

- 👉 White 📦 Plastic
- 👉 Blanco 📦 Plástico
- 👉 Bianco 📦 Plastica

#### Magnetic Switch

max. 60W  
DC 12V  
⌀13,5 ⇄40 ⚙20 mm  
EAN 4000870 709108  
**709.10** 📦



- ▶ Easy switching and dimming by touching
- ▶ Touch switch for state-of-the-art control of YourLED Strips
- ▶ Suitable for controlling 3000K, 4000K, 6000K monochrome strips
- ▶ Easy installation with adhesive pads
- ▶ Incl. memory effect

- ▶ Conmutación y regulación cómodas con un toque
- ▶ Interruptor táctil para un control moderno de Strips YourLED
- ▶ Adecuado para el control de strips monocolor 3000 K, 4000 K, 6000 K
- ▶ Fácil de montar mediante almohadillas adhesivas
- ▶ Con efecto memoria

- ▶ Commutazione e regolazione dell'intensità comode con sfioramento
- ▶ Interruttore touch per un controllo moderno delle Strip YourLED
- ▶ Per il controllo di Strips monocrome 3000K, 4000K, 6000K
- ▶ Montaggio semplice con cuscinetti adesivi
- ▶ Incluso Memory Effekt



- 👉 Silver 📦 Plastic
- 👉 Plateado 📦 Plástico
- 👉 Argento 📦 Plastica

#### Touch Switch

max. 60W  
DC 12V  
⌀8,5 ⇄43 ⚙30 mm  
EAN 4000870 709139  
**709.13** 📦



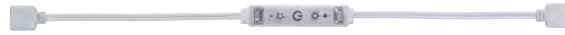

- ▶ Mini switch for easy control of YourLED Strips
- ▶ Suitable for controlling 3000K, 4000K, 6000K monochrome strips
- ▶ Interruptor Mini para un control práctico de Strips YourLED
- ▶ Adecuado para el control de strips monocolor 3000 K, 4000 K, 6000 K
- ▶ Mini-interruttore per un pratico controllo delle Strip YourLED
- ▶ Per il controllo di Strips monocrome 3000K, 4000K, 6000K

**Cord Switch**

max. 60 W  
DC 12 V  
⇅5,5 ⇄32 ⇄12 mm  
EAN 4000870 709146  
**709.14**

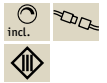

- 👉 White 📦 Plastic
- 👉 Blanco 📦 Plástico
- 👉 Bianco 📦 Plastica

- ▶ Dimmer switch for daylight-dependent control of YourLED Strips – for more comfort and security
- ▶ Suitable for controlling 3000K, 4000K, 6000K monochrome strips
- ▶ Fixed sensitivity (<20lux = light on)
- ▶ Easy installation with adhesive pads
- ▶ Interruptor crepuscular para la regulación en función de la luz diurna de Strips YourLED - para mayor control y seguridad
- ▶ Adecuado para el control de strips monocolor 3000 K, 4000 K, 6000 K
- ▶ Sensibilidad definida de forma fija (< 20 lux = luz encendida)
- ▶ Fácil de montar mediante almohadillas adhesivas
- ▶ Interruttore crepuscolare per il controllo dipendente dalla luce diurna delle Strip YourLED: crea comfort e sicurezza
- ▶ Per il controllo di Strips monocrome 3000K, 4000K, 6000K
- ▶ Sensibilità ben definita (<20Lux = luce accesa)
- ▶ Montaggio semplice con cuscinetti adesivi

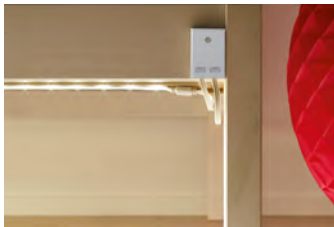
**Twilight Sensor**

max. 60 W  
DC 12 V  
⇅8,5 ⇄43 ⇄30 mm  
EAN 4000870 709153  
**709.15**



- 👉 Silver 📦 Plastic
- 👉 Plateado 📦 Plástico
- 👉 Argento 📦 Plastica

- ▶ Proximity switch switches on or off from 3cm
- ▶ Touch switch for contact-free control of YourLED Strips
- ▶ Suitable for controlling 3000K, 4000K, 6000K monochrome strips
- ▶ Easy installation with adhesive pads
- ▶ El interruptor de proximidad se enciende o se apaga a partir de 3 cm
- ▶ Interruptor táctil para un control sin contacto Strips YourLED
- ▶ Adecuado para el control de strips monocolor 3000 K, 4000 K, 6000 K
- ▶ Fácil de montar mediante almohadillas adhesivas
- ▶ L'interruttore di prossimità si accende o si spegne a partire da 3cm
- ▶ Interruttore touch per un controllo senza contatto delle Strip YourLED
- ▶ Per il controllo di Strips monocrome 3000K, 4000K, 6000K
- ▶ Montaggio semplice con cuscinetti adesivi

**PIR-Sensor**

max. 60 W  
DC 12 V  
⇅8,5 ⇄43 ⇄30 mm  
EAN 4000870 709160  
**709.16**

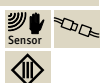

- 👉 Silver 📦 Plastic
- 👉 Plateado 📦 Plástico
- 👉 Argento 📦 Plastica



for  
Strip  
□ = 230–233

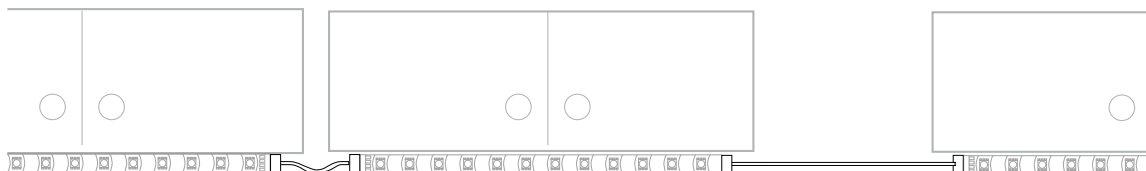

- 👉 White 📦 Plastic
- 👉 Blanco 📦 Plástico
- 👉 Bianco 📦 Plastica



**Flex-Connector 10cm**

⇄5 mm ⇄13 mm ⇄0,1 m  
EAN 4000870 702154  
**702.15** 📦



**Flex-Connector 1m**

⇄13 mm ⇄5 mm ⇄1 m  
EAN 4000870 702048  
**702.04** 📦



**Flex-Connector 5m**

max. 60 W  
⇄13 mm ⇄5 mm ⇄5 m  
EAN 4000870 702512  
**702.51** 📦



- ▶ Suitable for coated and uncoated YourLED Strips
- ▶ Fits all Paulmann profiles

- ▶ Adecuada para Strips YourLED con y sin recubrimiento
- ▶ Adecuado para todos los perfiles Paulmann

- ▶ Idoneo per Strips YourLED rivestite e non rivestite
- ▶ Per tutti i profili Paulmann



**Universal YourLED Connector**

max. 60 W  
⇄7 ⇄100 ⇄16 mm  
EAN 4000870 709184  
**709.18** 📦



- 👉 White 📦 Plastic
- 👉 Blanco 📦 Plástico
- 👉 Bianco 📦 Plastica

**Junction-Box**

max. 60 W  
⇄12 ⇄30 ⇄45 mm  
EAN 4000870 702031  
**702.03** 📦



- 👉 White 📦 Plastic
- 👉 Blanco 📦 Plástico
- 👉 Bianco 📦 Plastica

**X-Connector**

max. 60 W  
⇄7 ⇄33 ⇄33 mm  
EAN 4000870 702826  
**702.82** 📦

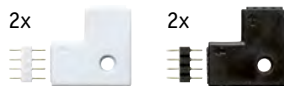

- 👉 White/Black
- 👉 Blanco/Negro
- 👉 Bianco/Nero

**Edge-Connector 90° Pack**

max. 60 W  
⇄5 ⇄23 ⇄23 mm  
EAN 4000870 705995  
**705.99** 📦





- 👉 White/Black
- 👉 Blanco/Negro
- 👉 Bianco/Nero

**Edge-Connector Pack**

max. 60 W  
 ⚡12 ⚡17 ⚡13 mm  
 EAN 4000870 703342  
**703.34**

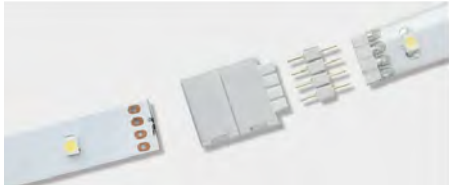

- 👉 White 🧱 Plastic
- 👉 Blanco 🧱 Plástico
- 👉 Bianco 🧱 Plastica

**ECO Clip-to-YourLED Connector Pack**

max. 60 W  
 ⚡6 ⚡13 ⚡18 mm  
 EAN 4000870 704905  
**704.90**



- 👉 White 🧱 Plastic
- 👉 Blanco 🧱 Plástico
- 👉 Bianco 🧱 Plastica

**ECO Clip Connector Pack**

⚡6 mm ⚡13,5 mm ⚡0,5 m  
 EAN 4000870 704882  
**704.88**



- 👉 White 🧱 Plastic
- 👉 Blanco 🧱 Plástico
- 👉 Bianco 🧱 Plastica

**ECO Clip-to-Clip Connector Pack**

max. 60 W  
 ⚡6 ⚡13,5 ⚡14 mm  
 EAN 4000870 704899  
**704.89**



- 👉 White 🧱 Plastic
- 👉 Blanco 🧱 Plástico
- 👉 Bianco 🧱 Plastica

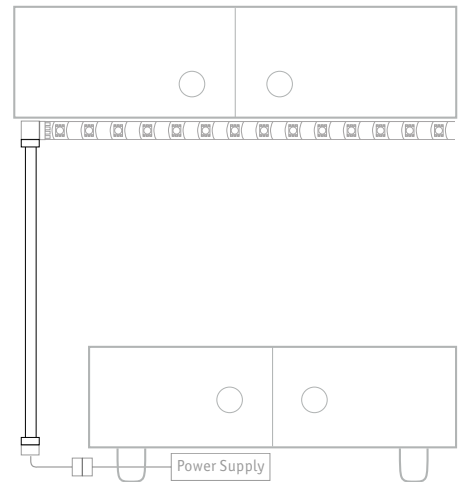

**Flat Connector**

max. 60 W  
 ⚡10 mm ⚡19 mm ⚡16,5 mm ⚡3 m  
 EAN 4000870 704868  
**704.86**



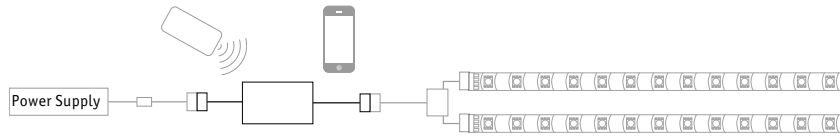

- 👉 White 📦 Plastic
- 👉 Blanco 📦 Plástico
- 👉 Bianco 📦 Plastica



smart  
controllable  
**Bluetooth®**



**YourLED Switch/Dimm Controller**

max. 60 W  
DC 12 V  
⌀19 ↔39 ↗80 mm  
EAN 4000870 500385  
**500.38** 📦



**YourLED RGB Controller**

max. 60 W  
DC 12 V  
⌀19 ↔39 ↗80 mm  
EAN 4000870 500392  
**500.39** 📦



smart  
controllable  
**zigbee**



**YourLED Switch/Dimm Controller**

max. 60 W  
DC 12 V  
⌀28 ↔38 ↗95 mm  
EAN 4000870 500484  
**500.48** 📦



**YourLED RGB Controller**

max. 60 W  
DC 12 V  
⌀28 ↔38 ↗95 mm  
EAN 4000870 500491  
**500.49** 📦





- 🔧 White 🏠 Plastic
- 🔧 Blanco 🏠 Plástico
- 🔧 Bianco 🏠 Plastica

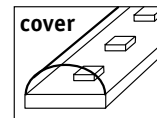

**Flaex LED**

- RGB
- smart controllable
- Bluetooth®



**Flaex LED Strip Set 5m RGB**

incl. 1x18 W  
 536 lm  
 ∠ 120°  
 230/12 V, incl. - 24 VA  
 ⌀ 3 mm ⌀ 10,5 mm ⇄ 5 m  
 EAN 4000870 500057  
**500.05**

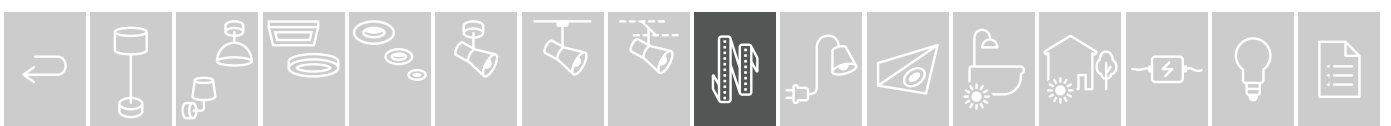

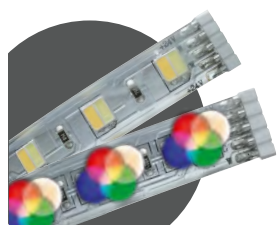

- 👉 White 🏠 Plastic
- 👉 Blanco 🏠 Plástico
- 👉 Bianco 🏠 Plastica

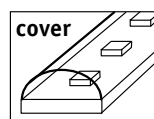

**Reflex LED**

-  tunable white
-  smart controllable
-  zigbee



**Reflex LED Strip Set 3m Tunable White**

incl. 1x20 W  
 1.650-1.740 lm, 3.000 - 6.500 K  
 <math>\sphericalangle 120^\circ</math>  
 230/24 V, incl. - 20 VA  
 <math>\varnothing 3\text{ mm}</math> <math>\varnothing 12,5\text{ mm}</math> <math>\leftrightarrow 3\text{ m}</math>  
 EAN 4000870 500804  
**500.80**



-  RGBW
-  smart controllable
-  zigbee



**Reflex LED Strip Set 3m RGBW**

incl. 1x20 W  
 750-780 lm, 3.000 K  
 <math>\sphericalangle 120^\circ</math>  
 230/24 V, incl. - 20 VA  
 <math>\varnothing 3\text{ mm}</math> <math>\varnothing 12,5\text{ mm}</math> <math>\leftrightarrow 3\text{ m}</math>  
 EAN 4000870 500811  
**500.81**



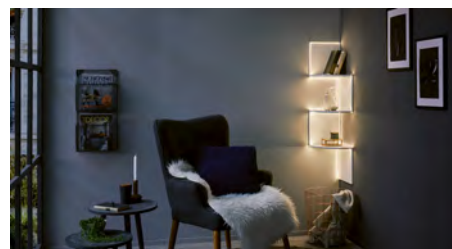

- ▶ FlexLED 3D Strips can be routed in any direction, as a curve, corner or edge – and no accessories are needed
- ▶ The complete sets incl. controller are an invitation to get started right away
- ▶ Las strips FlexLED 3D pueden instalarse en cualquier dirección, como curva, esquina o borde, sin accesorios
- ▶ Los juegos completos con control incluido son ideales para utilizarlos enseguida
- ▶ Le Strips FlexLED 3D possono essere posate in tutte le direzioni, sotto forma di curva, angolo o spigolo, il tutto senza dover utilizzare accessori
- ▶ I set completi incluso comando si ricaricano per poter essere utilizzati subito



- 👉 White 🏠 Plastic
- 👉 Blanco 🏠 Plástico
- 👉 Bianco 🏠 Plastica

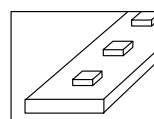

**FlexLED 3D**

320 lm/m    60 | 42 LED/m    3 mm x 8 | 10 mm    230/24V

warm white = 3.000 K

- ▶ The strips can be bent to a minimum angle of 60 degrees.
- ▶ Incl. cord dimmer switch
- ▶ Las strips pueden doblarse en un ángulo mínimo de 60°
- ▶ Regulador de luz con cable incluido
- ▶ Le Strips possono essere piegate a un angolo minimo di 60°
- ▶ Con interruttore a filo/dimmerabile

**Set**



↔ 1,5 m		480 lm		5 W		incl. 6 VA		EAN 4000870 789612	<b>789.61</b>
↔ 3 m		960 lm		8,0 W		incl. 12 VA		EAN 4000870 789629	<b>789.62</b>
↔ 5 m		1.600 lm		10,5 W		incl. 12 VA		EAN 4000870 789636	<b>789.63</b>

RGB

- ▶ The strips can be bent to a minimum angle of 90 degrees.
- ▶ Todas las strips pueden doblarse en un ángulo mínimo de 90°
- ▶ Le Strips possono essere piegate a un angolo minimo di 90°

**Set**



↔ 1,5 m		11 W		incl. 12 VA		EAN 4000870 789643	<b>789.64</b>
↔ 3 m		19 W		incl. 24 VA		EAN 4000870 789650	<b>789.65</b>
↔ 5 m		26 W		incl. 36 VA		EAN 4000870 789667	<b>789.66</b>



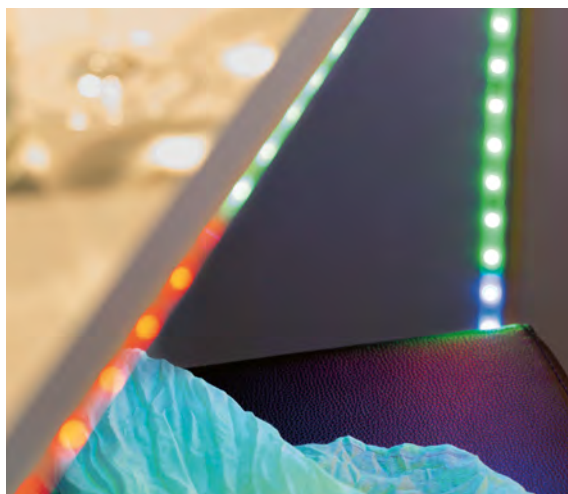

- ▶ LED Strip set with 164 functions for a range of different light effects, can be shortened electronically
- ▶ The digital control allows colours to be mixed in dynamic rhythms
- ▶ Can be dimmed or switched on or off by remote control.
- ▶ 3 LEDs can be disconnected from the strip end in segments. This allows the strip to be installed in a range of locations at the appropriate length.
- ▶ Juego de regleta LED electrónica acortable con 164 funciones para diversos efectos lumínicos
- ▶ El control digital permite mezclar colores a ritmos dinámicos
- ▶ Conmutable y regulable por mando a distancia.
- ▶ Desde el extremo de la regleta se pueden desconectar 3 LED por segmento. Así se puede colocar la regleta en la longitud adecuada en distintos lugares.
- ▶ Set di strisce LED accorciabili con 164 funzioni per molteplici effetti di luce
- ▶ Il sistema di comando digitale consente di miscelare i colori con ritmi dinamici
- ▶ Commutabile e regolabile tramite telecomando.
- ▶ Dalle estremità delle strisce è possibile disinserire 3 LED per segmento. In questo modo la striscia può essere utilizzata in diversi punti con una lunghezza differente.

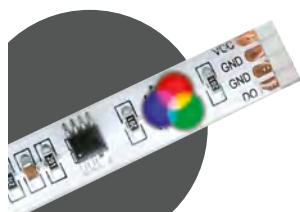

White Plastic  
Blanco Plástico  
Bianco Plastica

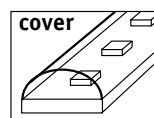

**Digital LED Strip Motion Color**

30 | 36 LED/m    3 mm x 10 mm

230/12V



RGB

**Set**



↔ 3 m	165 lm	10 W	incl. 12 VA	📶	EAN 4000870 704813	🏷️ 704.81
↔ 5 m	275 lm	16,5 W	incl. 18 VA	📶	EAN 4000870 704806	🏷️ 704.80



RGBW – W = 3.000 K

**Set**



↔ 1,5 m	535 lm	5,5 W	incl. 12 VA	📶	EAN 4000870 709092	🏷️ 709.09
↔ 3 m	1.070 lm	8 W	incl. 24 VA	📶	EAN 4000870 706961	🏷️ 706.96
↔ 4,8 m	1.710 lm	10,5 W	incl. 24 VA	📶	EAN 4000870 706978	🏷️ 706.97





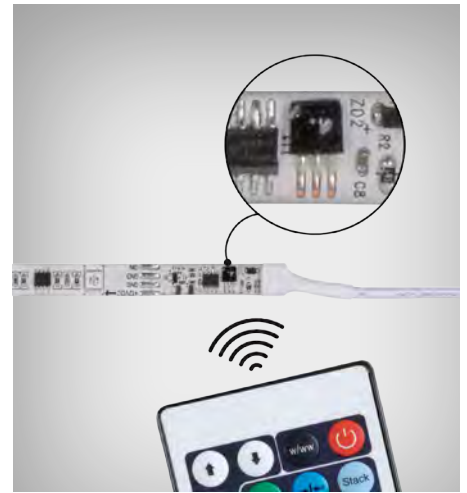

- ▶ Complete sets: Stick it on, plug it in and turn on the light!
- ▶ 164 great functions, from simple colour change to light sequencing, offer a fantastic variety of effects
- ▶ Simple controls via the supplied remote control
- ▶ Without receiver box – the IR receiver is compactly located directly on the strip
- ▶ Juegos completos: pegar, enchufar y encender la luz.
- ▶ 164 fantásticas funciones, desde el simple cambio de color hasta la luz dinámica, ofrecen múltiples posibilidades
- ▶ Control sencillo a través del mando a distancia incluido
- ▶ Sin caja de recepción; el receptor de infrarrojos se encuentra directamente en la strip, lo cual ahorra espacio
- ▶ Set completo: Basta incollare, inserire la spina e la luce si accende.
- ▶ 164 fantastiche funzioni dal semplice cambio di colore alla luce a scorrimento offrono un'ampia varietà
- ▶ Comandabili con telecomando incluso nella fornitura
- ▶ Senza scatola ricevitore: il ricevitore a infrarossi è collocato direttamente sulla Strip



White Plastic  
Blanco Plástico  
Bianco Plastica

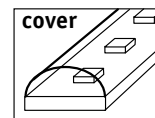

**SimpLED Motion** 65 lm/m 30LED/m 3 mm x 8 mm 230/24 V

RGB

**Set**



↔ 10,04 m		650 lm		17 W		incl. 18 VA	🔌	EAN 4000870 705155	🛒 705.15
↔ 7,64 m		494 lm		15 W		incl. 18 VA	🔌	EAN 4000870 705148	🛒 705.14
↔ 5,04 m		325 lm		10 W		incl. 12 VA	🔌	EAN 4000870 705131	🛒 705.13





- ▶ Complete sets: Stick it on, plug it in and turn on the light!
- ▶ Extremely powerful LED strips for interior lighting
- ▶ Controllable via the supplied cord dimming switch
- ▶ Juegos completos: pegar, enchufar y encender la luz.
- ▶ Strips LED extremadamente potentes, p. ej., para la iluminación de interiores
- ▶ Control mediante el regulador de luz con cable
- ▶ Set completo: Basta incollare, inserire la spina e la luce si accende.
- ▶ Strips LED estremamente potenti ad es. per l'illuminazione dell'ambiente
- ▶ Comandabili con interruttore a filo/dimmerabile incluso nella fornitura



White  Plastic  
 Blanco  Plástico  
 Bianco  Plastica

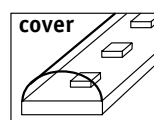

### SimpLED Power

1100 lm/m

72 LED/m

± 3 mm ↗ 10 mm

230/24 V

● warm white = 3.000 K

#### Set



↔ 1,5 m		1.650 lm		17 W		incl. ⚡ 24 VA	🔌	EAN 4000870 789551	🛒 <b>789.55</b>
↔ 3 m		3.300 lm		33 W		incl. ⚡ 48 VA	🔌	EAN 4000870 789568	🛒 <b>789.56</b>
↔ 5 m		5.500 lm		50 W		incl. ⚡ 60 VA	🔌	EAN 4000870 789575	🛒 <b>789.57</b>

○ neutral white = 4.000 K

#### Set

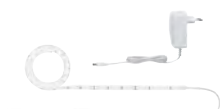

↔ 1,5 m		1.650 lm		17 W		incl. ⚡ 24 VA	🔌	EAN 4000870 789582	🛒 <b>789.58</b>
↔ 3 m		3.300 lm		33 W		incl. ⚡ 48 VA	🔌	EAN 4000870 789599	🛒 <b>789.59</b>
↔ 5 m		5.500 lm		50 W		incl. ⚡ 60 VA	🔌	EAN 4000870 789605	🛒 <b>789.60</b>





- ▶ Complete sets: Stick it on, plug it in and turn on the light!
- ▶ Available in many different lengths and light colours
- ▶ The RGB version is controlled via the supplied remote control

- ▶ Juegos completos: pegar, enchufar y encender la luz.
- ▶ Disponible en muchas longitudes y tonalidades de luz
- ▶ La versión RGB se puede controlar a través del mando a distancia incluido

- ▶ Set completi: Basta incollare, inserire la spina e la luce si accende.
- ▶ Disponibili in molte lunghezze e molti colori della luce
- ▶ La versione RGB è comandabile con telecomando incluso nella fornitura

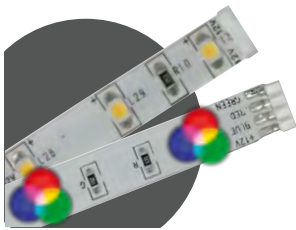

- 🔌 White 📏 Metal/Plastic
- 🔌 Blanco 📏 Metal/Plástico
- 🔌 Bianco 📏 Metallo/Plastica

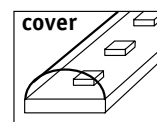

**SimpLED** 100–190 lm/m 30 | 60 LED/m ⬆ 3 mm ⬆ 10 mm 230/12V

**RGB**

**Set**



↔ 5 m		505 lm		20 W		incl. ⚡ 24 VA	🔌	EAN 4000870 789780	🛒 <b>789.78</b>
↔ 7,5 m		760 lm		26 W		incl. ⚡ 36 VA	🔌	EAN 4000870 789797	🛒 <b>789.79</b>
↔ 10 m		1.010 lm		28 W		incl. ⚡ 36 VA	🔌	EAN 4000870 789803	🛒 <b>789.80</b>

**warm white = 3.000 K**

**Set**



↔ 5 m		1.500 lm		17 W		incl. ⚡ 18 VA	🔌	EAN 4000870 789728	🛒 <b>789.72</b>
↔ 7,5 m		2.250 lm		20 W		incl. ⚡ 24 VA	🔌	EAN 4000870 789735	🛒 <b>789.73</b>
↔ 10 m		3.000 lm		22 W		incl. ⚡ 36 VA	🔌	EAN 4000870 789742	🛒 <b>789.74</b>

**daylight = 6.500 K**

**Set**



↔ 5 m		1.550 lm		17 W		incl. ⚡ 18 VA	🔌	EAN 4000870 789759	🛒 <b>789.75</b>
↔ 7,5 m		2.325 lm		20 W		incl. ⚡ 24 VA	🔌	EAN 4000870 789766	🛒 <b>789.76</b>
↔ 10 m		3.100 lm		22 W		incl. ⚡ 36 VA	🔌	EAN 4000870 789773	🛒 <b>789.77</b>



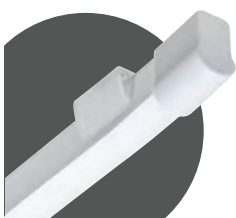

White Plastic  
 Blanco Plástico  
 Bianco Plastica

IP44 IP65

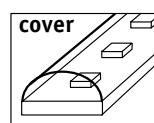

**SimpLED Outdoor new** 420 lm/m 40 LED/m  $\updownarrow$  15,5 mm  $\nearrow$  8,5 mm 230/24V

warm white = 3.000 K



**Set**

$\leftrightarrow$ 3 m		1.260 lm		12 W		incl.  18 VA	EAN 4000870 789056	<b>789.05</b>
$\leftrightarrow$ 5 m		2.100 lm		20 W		incl.  24 VA	EAN 4000870 789063	<b>789.06</b>

daylight = 6.500 K



**Set**

$\leftrightarrow$ 3 m		1.260 lm		12 W		incl.  18 VA	EAN 4000870 789070	<b>789.07</b>
$\leftrightarrow$ 5 m		2.100 lm		20 W		incl.  24 VA	EAN 4000870 789087	<b>789.08</b>





- ▶ Fully jacketed LED strips for decorative outdoor lighting in the garden, at the property entrance, below lintels, in damp rooms or for many other uses (IP67 - able to withstand immersion in water).
- ▶ Plug-and-play: Complete set with plug for easy installation
- ▶ Incl. transformer (IP 64: dust-proof and splash-protected).
- ▶ Incl. 1 m power cable - 5 m extension cable available as accessory (IP 65: waterjet-protected)
- ▶ LED strips can be shortened every 10 cm - end cap and silicone sealing agent incl.
- ▶ For loose placement or fixed installation using plastic brackets (incl.)
- ▶ Not suitable for use in the vicinity of aggressive chemicals (chlorine water and similar)
- ▶ Regletas de red completamente revestidas para iluminación exterior decorativa en el jardín, en la entrada a la casa, bajo el alero, en espacios húmedos y en muchos otros lugares (IP67 - protección contra inmersión en agua).
- ▶ Plug'n'play: juego completo listo para enchufar, simplificándose el tendido
- ▶ Transformador incl. (IP64 - hermético al polvo y a salpicaduras de agua).
- ▶ Cable de alim. de 1 m incl. (prolongador de 5 m disponible como accesorio; IP65 - resistente a chorro de agua proyectada)
- ▶ Las regletas de LEDs se pueden recortar cada 10 cm (moldura de cierre y sellado de silicona incluidos)
- ▶ Para tendido libre o para fijar con presillas de plástico (incluidas)
- ▶ No apto para ambientes con sustancias químicas agresivas (p.ej. agua clorada)
- ▶ Strisce di LED rivestite su tutti i lati per illuminazione decorativa di esterni: in giardino, sopra l'ingresso, sotto la traversa del tetto, in ambienti umidi e in molti altri punti (protezione contro l'immersione in acqua - IP67).
- ▶ Plug ,n' play: set completo pronto al collegamento per la massima facilità di posa
- ▶ Trasformatore incluso (con protezione contro penetrazione di polvere e spruzzi d'acqua - IP64).
- ▶ Cavo di alimentazione da 1 m incluso - Prolunga da 5 m disponibile come accessorio (con protezione dai getti diretti d'acqua - IP65)
- ▶ Le strisce di LED sono accorciabili ogni 10 cm - Calotta terminale e sigillante al silicone inclusi
- ▶ Per la posa mobile o il fissaggio con staffe in plastica (incluse)
- ▶ Non adatte all'impiego in presenza di sostanze chimiche aggressive (acqua clorurata o simili)



White Plastic  
Blanco Plástico  
Bianco Plastica

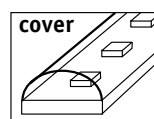
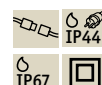

**WaterLED**

140 lm/m

13LED/m

4,5 mm 14 mm

230/12V

neutral white = 4.000 K

**Set**



3 m	420 lm	7 W	incl. 7,2 VA	EAN 4000870 704196	704.19
5 m	700 lm	10,5 W	incl. 12 VA	EAN 4000870 704189	704.18
7,5 m	1,000 lm	14 W	incl. 18 VA	EAN 4000870 704172	704.17

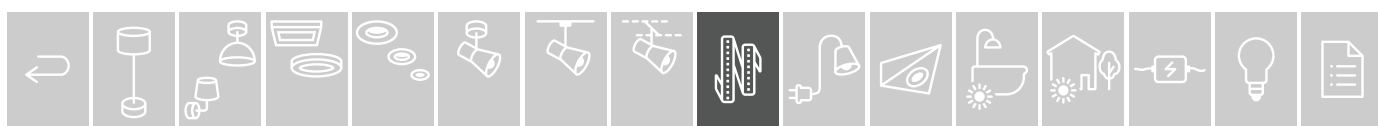

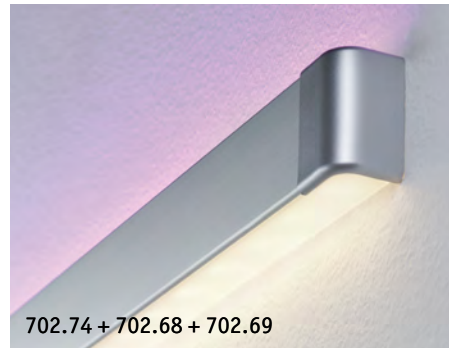

- ▶ High-quality double-T profile made of aluminium with anodised finish – for two-sided light effects
- ▶ Multi-purpose lighting with LED strips
- ▶ Decorative light for presentation of living spaces
- ▶ Optional diffuser for uniform light distribution
- ▶ For wall, ceiling or corner mounting
- ▶ Versatile accessories for installation and profile end caps
- ▶ Including cable guides
- ▶ Positive cooling effect for LED Strips
- ▶ Available as individual components or in a practical set

- ▶ Perfil de gran calidad de doble T en aluminio con superficie anodizada – para efectos lumínicos bilaterales
- ▶ Para una iluminación versátil con strips LED
- ▶ Iluminación decorativa para una puesta en escena de espacios habitables
- ▶ Difusor opcional para una distribución uniforme de la luz
- ▶ Para instalación en pared, techo o esquinas
- ▶ Accesorios versátiles para el tendido y perfiles embellecedores
- ▶ Incl. guía para cables
- ▶ Positivo efecto refrescante para regletas de LEDs
- ▶ Disponibles como componentes individuales o en un práctico juego

- ▶ Profilo a doppia T di qualità in alluminio con superficie anodizzata - per effetti di luce su due lati
- ▶ Per illuminazione variegata con Strip LED
- ▶ Luce decorativa per l'allestimento luminoso degli spazi abitativi
- ▶ Diffusore opzionale per la distribuzione omogenea della luce
- ▶ Per il montaggio a parete, a soffitto o ad angolo
- ▶ Molteplici accessori per la posa e la chiusura dei profilati
- ▶ Comprensivo di canalina per cavi
- ▶ Effetto positivo rinfrescante delle strisce LED
- ▶ Disponibili come componenti singoli o come pratico set



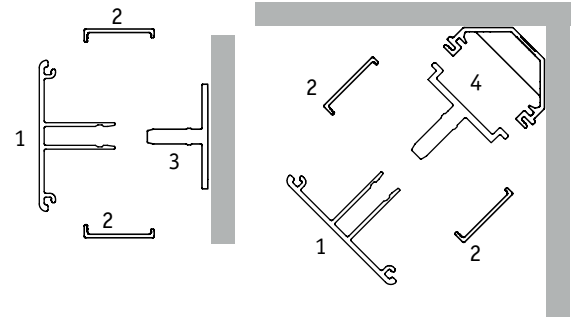
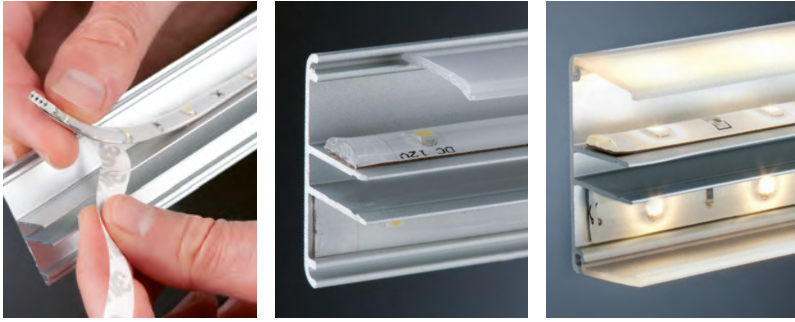

**Duo Profil Set incl. Clips & Diffusor**

⌀40 mm ⌀20 mm ⇄1 m  
EAN 4000870 705209  
**705.20**

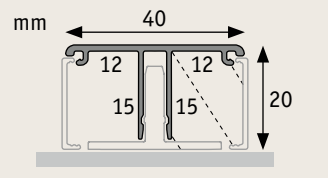

**Duo Profil Set incl. Clips & Diffusor**

⌀40 mm ⌀20 mm ⇄2 m  
EAN 4000870 705193  
**705.19**

- ⌘ Anodised aluminium
- ⌘ Aluminium
- ⌘ Aluminio anodizado
- ⌘ Aluminio
- ⌘ Alluminio anodizzato
- ⌘ Alluminio

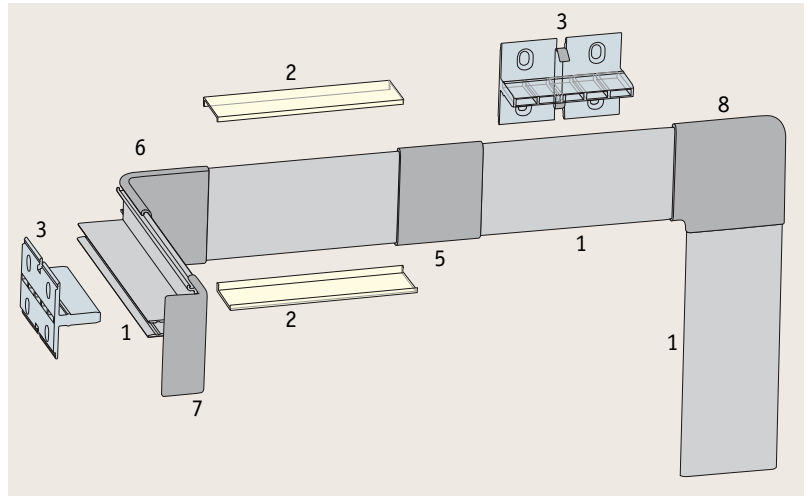

**Duo Profil 1m**

⌀40 mm ⌀20 mm ⇄1 m  
EAN 4000870 702680  
**702.68**



**Duo Profil 2m**

⌀40 mm ⌀20 mm ⇄2 m  
EAN 4000870 702673  
**702.67**

**Duo Profil Diffusor**

⌀4 mm ⌀20 mm ⇄2 m  
EAN 4000870 702697  
**702.69**

**Duo Profil Fixture**

⌀36 ⇄50 ⌀21 mm  
EAN 4000870 702758  
**702.75**

**Duo Profil Clix**

⌀40 ⇄36 ⌀37 mm  
EAN 4000870 702215  
**702.21**

- ⌘ Aluminium ⌘ Aluminium
- ⌘ Aluminio ⌘ Aluminio
- ⌘ Alluminio ⌘ Alluminio

- ⌘ Satin ⌘ Plastic
- ⌘ Satinado ⌘ Plástico
- ⌘ Satinato ⌘ Plastica

- ⌘ Transparent ⌘ Plastic
- ⌘ Transparente ⌘ Plástico
- ⌘ Trasparente ⌘ Plastica

- ⌘ Transparent ⌘ Plastic
- ⌘ Transparente ⌘ Plástico
- ⌘ Trasparente ⌘ Plastica

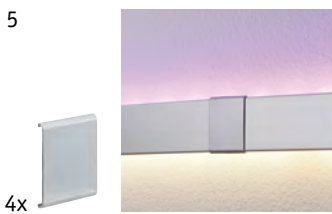

**Duo Profil Cover**

⌀42 ⇄35 ⌀5 mm  
EAN 4000870 702703  
**702.70**

- ⌘ Matt aluminium ⌘ Plastic
- ⌘ Aluminio mate ⌘ Plástico
- ⌘ Alluminio opaco ⌘ Plastica



**Duo Profil Inside Corner**

⌀42 ⇄39 ⌀39 mm  
EAN 4000870 702727  
**702.72**

- ⌘ Matt aluminium ⌘ Plastic
- ⌘ Aluminio mate ⌘ Plástico
- ⌘ Alluminio opaco ⌘ Plastica

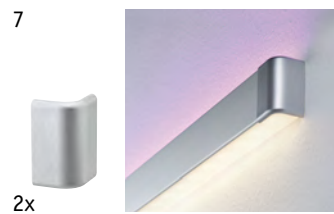

**Duo Profil End Cap**

⌀42 ⇄22 ⌀24 mm  
EAN 4000870 702741  
**702.74**

- ⌘ Matt aluminium ⌘ Plastic
- ⌘ Aluminio mate ⌘ Plástico
- ⌘ Alluminio opaco ⌘ Plastica



**Duo Profil 90° Corner**

⌀20 ⇄60 ⌀60 mm  
EAN 4000870 704530  
**704.53**

- ⌘ Matt aluminium ⌘ Plastic
- ⌘ Aluminio mate ⌘ Plástico
- ⌘ Alluminio opaco ⌘ Plastica



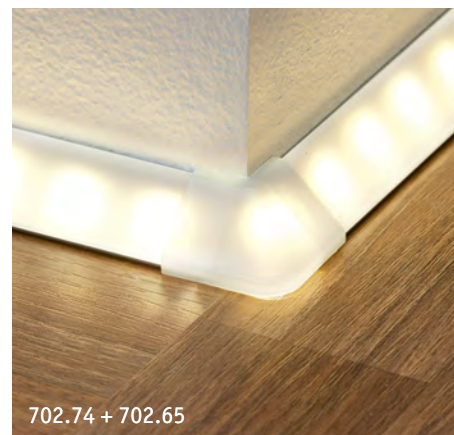
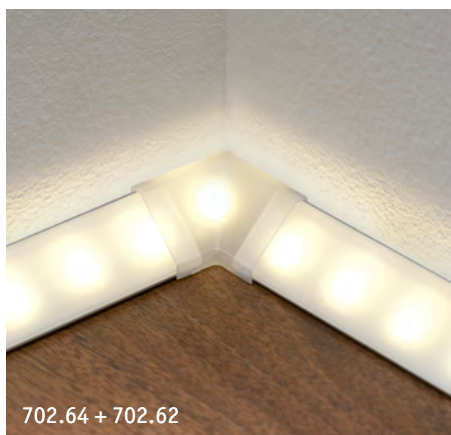

- ▶ High-quality angle profile made of aluminium with anodised finish including diffuser
- ▶ Multi-purpose lighting with LED strips
- ▶ Decorative light for presentation of baseboards or closing edges
- ▶ Additional lighting for utility spaces or under cabinets
- ▶ Orientation and guide lights at shadow and danger zones
- ▶ Versatile accessories for installation and profile end caps
- ▶ Also usable as continuous lighting by employing economical LED Strips
- ▶ Positive cooling effect for LED Strips

- ▶ Perfil en ángulo de gran calidad en aluminio con superficie anodizada – incluido difusor
- ▶ Para una iluminación versátil con strips LED
- ▶ Iluminación decorativa para una puesta en escena de rodapiés o remates de esquinas
- ▶ Iluminación adicional de superficies útiles o bajo armarios
- ▶ Luz de orientación y de guía para zonas en penumbra o peligrosas
- ▶ Accesorios versátiles para el tendido y perfiles embellecedores
- ▶ El empleo de regletas de LEDs de bajo consumo permite también su utilización como iluminación permanente
- ▶ Positivo efecto refrescante para regletas de LEDs

- ▶ Profilito angolare di qualità in alluminio con superficie anodizzata con diffusore
- ▶ Per illuminazione variegata con Strip LED
- ▶ Luce decorativa per l'allestimento luminoso di battiscopa o di bordi di chiusura
- ▶ Illuminazione aggiuntiva di superfici utili o di sottopensili
- ▶ Luce direzionale e di orientamento per le zone d'ombra o le aree pericolose
- ▶ Molteplici accessori per la posa e la chiusura dei profilati
- ▶ Utilizzabile anche per l'illuminazione costante grazie all'impiego delle strisce di LED a basso consumo energetico
- ▶ Effetto positivo rinfrescante delle strisce LED







2013

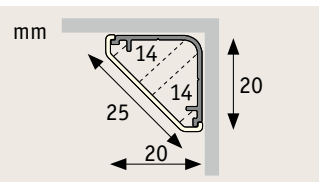
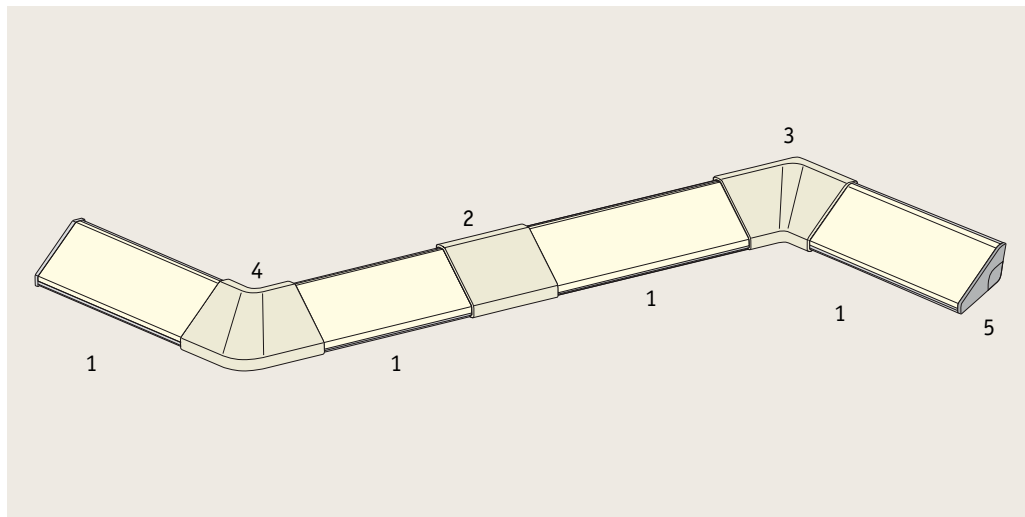
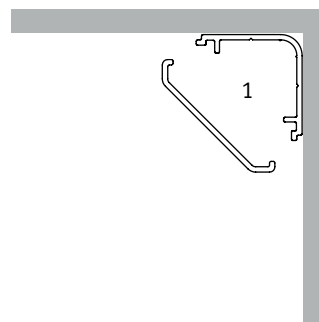

**Delta Profil 2m**  
 ⚡20 mm ⚡20 mm ⇄2 m  
 EAN 4000870 702611  
**702.61**

- ⌘ Aluminium/Satin ⌘ Aluminium/Plastic
- ⌘ Aluminio/Satinado ⌘ Aluminio/Plástico
- ⌘ Alluminio/Satinato ⌘ Alluminio/Plastica



**Delta Profil 1m**  
 ⚡20 mm ⚡20 mm ⇄1 m  
 EAN 4000870 702628  
**702.62**

- ⌘ Aluminium/Satin ⌘ Aluminium/Plastic
- ⌘ Aluminio/Satinado ⌘ Aluminio/Plástico
- ⌘ Alluminio/Satinato ⌘ Alluminio/Plastica



**Delta Profil Cover**  
 ⚡29 ⇄35 ⚡5 mm  
 EAN 4000870 702635  
**702.63**

- ⌘ Satin ⌘ Plastic
- ⌘ Satinado ⌘ Plástico
- ⌘ Satinato ⌘ Plastica



**Delta Profil Inside Corner**  
 ⚡21 ⇄35 ⚡35 mm  
 EAN 4000870 702642  
**702.64**

- ⌘ Satin ⌘ Plastic
- ⌘ Satinado ⌘ Plástico
- ⌘ Satinato ⌘ Plastica



**Delta Profil Outside Corner**  
 ⚡21 ⇄35 ⚡35 mm  
 EAN 4000870 702659  
**702.65**

- ⌘ Satin ⌘ Plastic
- ⌘ Satinado ⌘ Plástico
- ⌘ Satinato ⌘ Plastica



**Delta Profil End Cap**  
 ⚡20 ⇄8 ⚡20 mm  
 EAN 4000870 702666  
**702.66**

- ⌘ Matt aluminium ⌘ Plastic
- ⌘ Aluminio mate ⌘ Plástico
- ⌘ Alluminio opaco ⌘ Plastica





🔩 Aluminium/Satin 🔩 Aluminium/Plastic  
🔩 Aluminio/Satinado 🔩 Aluminio/Plástico  
🔩 Alluminio/Satinato 🔩 Alluminio/Plastica

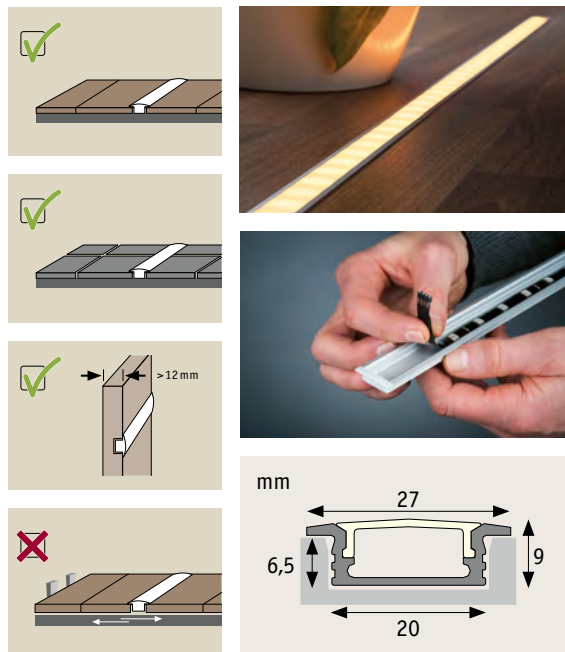

- ▶ Recessed profile for illumination with LED strips creates attractive lighting effects. Can also be used as orientation and guide lights at shadow and danger zones.
- ▶ High-quality aluminium profile with satin cover on which it is safe to walk (can withstand up to 130 kg)
- ▶ Uniform light distribution
- ▶ Can be installed in milled grooves on materials with a thickness of 12 mm or more or can be permanently glued to laminate flooring, tiles and carpets.
- ▶ Incl. end caps
- ▶ Not suitable for installation on floating laminate
- ▶ Perfil empotrable para iluminación con regletas de LEDs que crea atractivos efectos de luz. Apto también para usar como luz guía o de orientación.
- ▶ Perfil de aluminio de excelente calidad con cubierta resistente a la pisada (hasta 130 kg)
- ▶ Distribución lumínica uniforme
- ▶ Para integrar en materiales a partir de 12 mm de grosor o para pegar de forma fija en baldosas, moquetas o suelos laminados.
- ▶ Incluye molduras de cierre
- ▶ No apto para suelos laminados flotantes
- ▶ Profilo da incasso per illuminazione con strisce di LED, per creare affascinanti effetti luminosi. Utilizzabile anche come luce direzionale o di orientamento.
- ▶ Profilato in alluminio di alta qualità con copertura calpestabile (130 kg max.)
- ▶ Distribuzione omogenea della luce
- ▶ Per montaggio a incasso in materiali a partire da 12 mm di spessore o per incollaggio permanente su laminato, piastrelle e moquette.
- ▶ Calotte terminali incluse
- ▶ Non adatto per il montaggio su laminato galleggiante



**Floor Profil 1m**

⚙️ 9 ⇄ 1.010 ↗️ 27 mm  
 EAN 4000870 704103  
**704.10**

ALU	☀️
rost	
frei	
↓ Kg	
130	

**Floor Profil 2m**

⚙️ 9 ⇄ 2.010 ↗️ 27 mm  
 EAN 4000870 704097  
**704.09**

ALU	☀️
rost	
frei	
↓ Kg	
130	

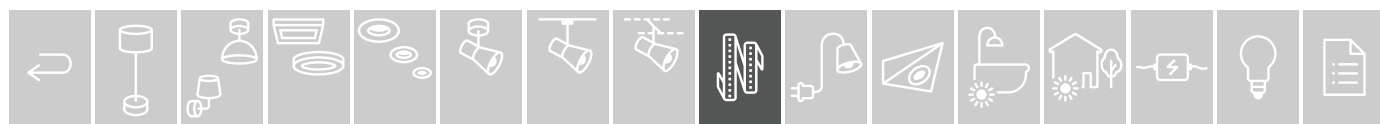



- 🔧 Grey 🏠 Plastic
- 🔧 Gris 🏠 Plástico
- 🔧 Grigio 🏠 Plastica

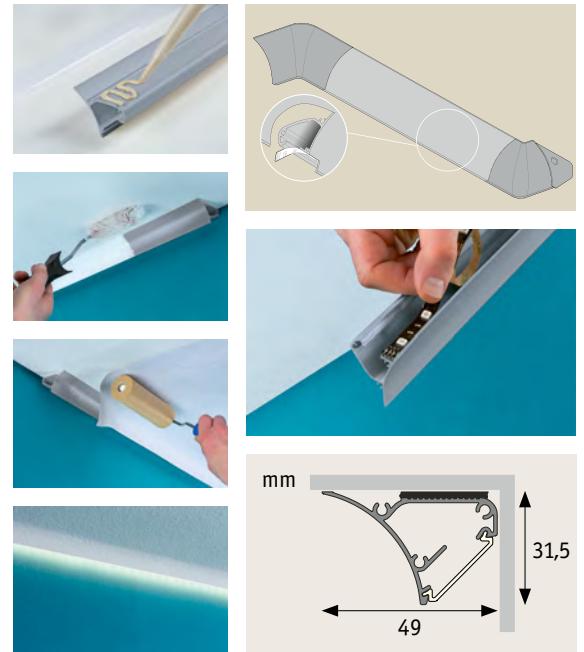

- ▶ Decorative ceiling profile for shining indirect light onto the wall with LED strips
- ▶ Uniform light distribution
- ▶ End caps for straight wall cuts included in scope of supply
- ▶ Inner and outer corners available as accessories
- ▶ Outer corners can also be used as start and end points on straight sections.
- ▶ Can be fastened with customary construction adhesives
- ▶ For laying LED strips and cable connections.

- ▶ Decorativo perfil de techo para iluminación indirecta de la pared con regletas de LEDs.
- ▶ Distribución lumínica uniforme
- ▶ Se suministra junto con molduras de cierre para secciones de pared rectas
- ▶ Rinconeros y esquineros disponibles como accesorios
- ▶ Los esquineros pueden usarse igualmente como punto inicial o final en tramos rectos.
- ▶ Fijación mediante adhesivos de construcción comerciales
- ▶ Para el tendido de regletas de LEDs y conectores de cables.

- ▶ Profilo decorativo per soffitto per l'illuminazione indiretta di pareti con strisce a LED.
- ▶ Distribuzione omogenea della luce
- ▶ Calotte terminali incluse nel volume di consegna per montaggio anche a metà parete
- ▶ Angoli interni ed esterni disponibili come accessori
- ▶ Angoli esterni utilizzabili anche come elemento iniziale o finale su un tratto rettilineo.
- ▶ Fissaggio con adesivi da costruzione comunemente in commercio
- ▶ Per la posa di strisce di LED e connettori per cavi.

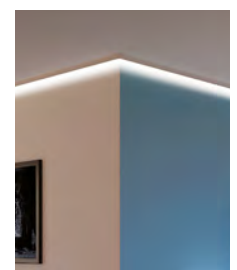

#### Corner Profil 1m

⌈31,5 mm ⌋49 mm ⇔1 m  
EAN 4000870 704400  
**704.40** 📦

#### Corner Profil Inside Edge

⌈31,5 ⇔59 ⌋59 mm  
EAN 4000870 704424  
**704.42** 📦

- 🔧 Grey 🏠 Plastic
- 🔧 Gris 🏠 Plástico
- 🔧 Grigio 🏠 Plastica

#### Corner Profil Outside Edge

⌈31,5 ⇔49 ⌋49 mm  
EAN 4000870 704417  
**704.41** 📦

- 🔧 Grey 🏠 Plastic
- 🔧 Gris 🏠 Plástico
- 🔧 Grigio 🏠 Plastica

#### Corner Profil 2m

⌈31,5 mm ⌋49 mm ⇔2 m  
EAN 4000870 704394  
**704.39** 📦



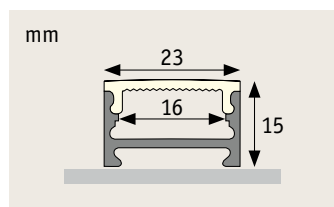
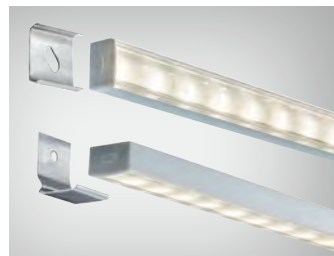

- ▶ Support profile for many practical applications
- ▶ Beam angle 120°
- ▶ Uniform light distribution
- ▶ Diffuser edge lights up
- ▶ Incl. two types of practical attachment clips for flat or tilted mounting
- ▶ Wall mounting possible

- ▶ Perfil de montaje para numerosas aplicaciones prácticas
- ▶ Distribución lumínica uniforme
- ▶ Borde del difusor con luz
- ▶ Con dos tipos de clips de sujeción prácticos para el montaje plano o inclinado
- ▶ Posibilidad de montaje en la pared

- ▶ Profilo per il montaggio per numerose applicazioni pratiche
- ▶ Distribuzione omogenea della luce
- ▶ Con due tipi di clip di fissaggio pratiche per montaggio piatto o inclinato.
- ▶ Possibilità di montaggio a parete



#### Square Profil 1m

15 mm 23 mm 1 m  
EAN 4000870 789049

**789.04 new**

- 🔗 Black 📦 Aluminium/Plastic
- 🔗 Negro 📦 Aluminio/Plástico
- 🔗 Nero 📦 Alluminio/Plastica

ALU  
rost  
frei

#### Square Profil 2m

15 mm 23 mm 2 m  
EAN 4000870 789032

**789.03 new**

ALU  
rost  
frei



#### Square Profil 1m

15 mm 23 mm 1 m  
EAN 4000870 708095

**708.09**

- 🔗 Aluminium/Satin 📦 Aluminium/Plastic
- 🔗 Aluminio/Satinado 📦 Aluminio/Plástico
- 🔗 Alluminio/Satinato 📦 Alluminio/Plastica

ALU  
rost  
frei

#### Square Profil 2m

15 mm 23 mm 2 m  
EAN 4000870 708101

**708.10**

ALU  
rost  
frei



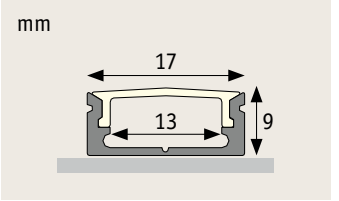
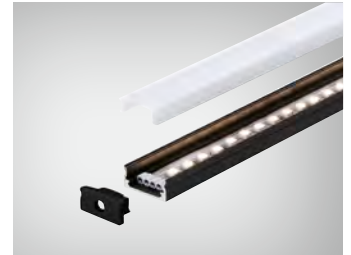

**Base Profil 1m**

⇄ 9 mm ⇄ 17 mm ⇄ 1 m  
EAN 4000870 789025

**789.02 new**

- 🔧 Black 📦 Aluminium/Plastic
- 🔧 Negro 📦 Aluminio/Plástico
- 🔧 Nero 📦 Alluminio/Plastica

ALU  
rost  
frei

**Base Profil 2m**

⇄ 9 mm ⇄ 17 mm ⇄ 2 m  
EAN 4000870 789018

**789.01 new**

ALU  
rost  
frei



**Base Profil 1m**

⇄ 9 mm ⇄ 17 mm ⇄ 1 m  
EAN 4000870 705179

**705.17**

- 🔧 Anodised aluminium/Satin 📦 Aluminium/Plastic
- 🔧 Aluminio anodizado/Satinado 📦 Aluminio/Plástico
- 🔧 Alluminio anodizzato/Satinato 📦 Alluminio/Plastica

ALU  
rost  
frei

**Base Profil 2m**

⇄ 9 mm ⇄ 17 mm ⇄ 2 m  
EAN 4000870 705186

**705.18**

ALU  
rost  
frei



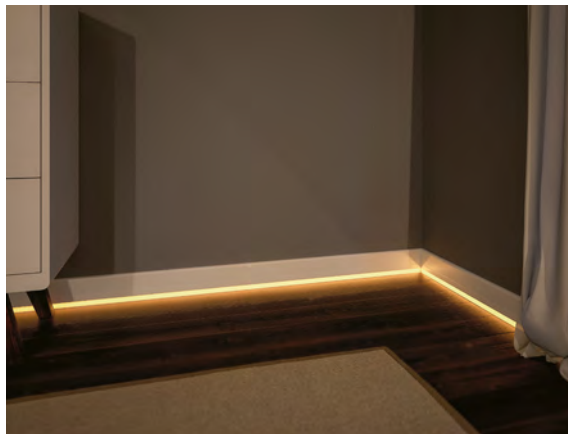

⚙ Anodised aluminium/Satin 🏠 Aluminium/Plastic  
 ⚙ Aluminio anodizado/Satinado 🏠 Aluminio/Plástico  
 ⚙ Alluminio anodizzato/Satinato 🏠 Alluminio/Plastica

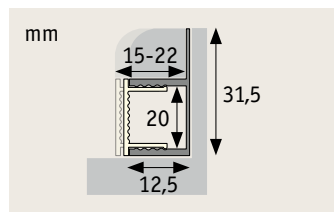
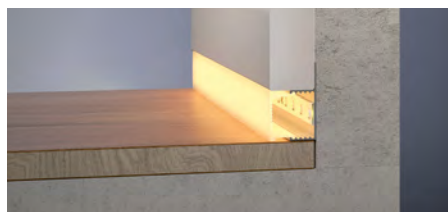

- ▶ Illuminated profile under the skirting board
- ▶ Perfectly adapted to standard skirting boards made of wood and plastic (all standard thicknesses from 15-22mm are supported)
- ▶ Socle profile can also be used on floating laminate
- ▶ Perfil iluminado debajo del rodapié
- ▶ Adaptado de forma óptima a los rodapiés de madera y material sintético habituales del mercado (compatible con todos los grosores de listón habituales de 15-22 mm)
- ▶ Socle Profil también es apto para el uso en suelos laminados flotantes
- ▶ Profilo illuminato sotto la barra di base
- ▶ Perfetto su barre di base in legno e plastica reperibili in commercio (sono supportati tutti gli spessori comuni delle barre nell'ordine dei 15-22mm)
- ▶ Il profilo Socle è utilizzabile anche su laminato galleggiante



**Socle Profil 1m**

⚡ 35 mm ⚡ 12,5 mm ⚡ 1 m  
 EAN 4000870 708620  
**708.62**

**Socle Profil 2m**

⚡ 35 mm ⚡ 12,5 mm ⚡ 2 m  
 EAN 4000870 708637  
**708.63**



⚙ Anodised aluminium/Satin 🏠 Aluminium/Plastic  
 ⚙ Aluminio anodizado/Satinado 🏠 Aluminio/Plástico  
 ⚙ Alluminio anodizzato/Satinato 🏠 Alluminio/Plastica

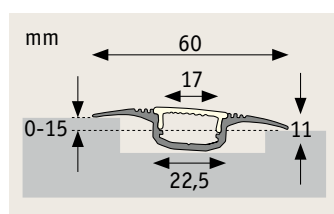

- ▶ Illuminated transition profile
- ▶ Illuminated room divider and differentiation of areas with different floor coverings
- ▶ Can also be used on floating laminate
- ▶ Secure screw mounting
- ▶ Can be walked on and is non-slip
- ▶ Perfil de transición iluminado
- ▶ Separador de estancias iluminado y delimitación de áreas con revestimientos de suelo diferentes
- ▶ Apto para el uso en suelos laminados flotantes
- ▶ Fijación segura con tornillos
- ▶ Resistente a pisadas y antideslizante
- ▶ Profilo di passaggio illuminato
- ▶ Separatore di ambienti e delimitatore di zone illuminato per diversi rivestimenti per pavimenti
- ▶ Utilizzabile anche su laminato galleggiante
- ▶ Fissaggio sicuro delle viti
- ▶ Calpestabile e antiscivolo

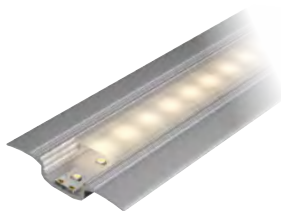

**Step Profil 1m**

⚡ 11 mm ⚡ 60 mm ⚡ 1 m  
 EAN 4000870 708552  
**708.55**

**Step Profil 2m**

⚡ 11 mm ⚡ 60 mm ⚡ 2 m  
 EAN 4000870 708569  
**708.56**



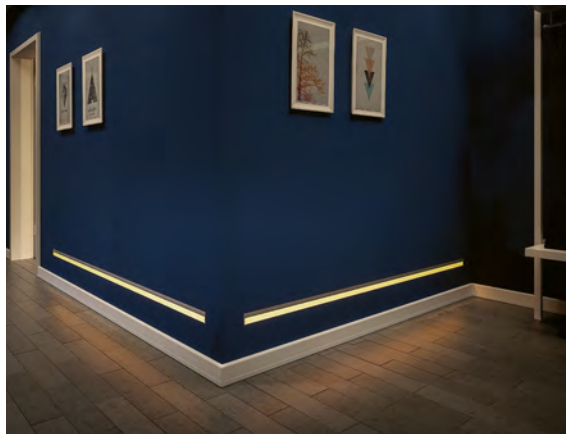

⚡ Anodised aluminium/Satin  
 🗪 Aluminium/Plastic  
 ⚡ Aluminio anodizado/Satinado  
 🗪 Aluminio/Plástico  
 ⚡ Alluminio anodizzato/Satinato  
 🗪 Alluminio/Plastica

mm

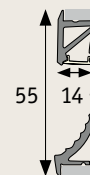

- ▶ Illuminated recessed profile between the plasterboard panels
- ▶ Allows for modern orientation light and wall design that stays close to the architecture
- ▶ Designed for dry walls with standard plasterboard panels (12.5mm) and stud frames
- ▶ Serviceable: the profile can later be removed from the holders as required
- ▶ The cable guides are supported

- ▶ Perfil empotrado iluminado entre los paneles de cartón yeso
- ▶ Permite una luz de orientación moderna en combinación con un diseño de pared cercano a la arquitectura
- ▶ Concebido para sistemas de construcción en seco con paneles de cartón yeso estándar (12,5 mm) y estructuras de celosía
- ▶ Permite el mantenimiento: si es necesario, el perfil se puede separar posteriormente de los soportes
- ▶ Permite guías de cables

- ▶ Profilo da incasso illuminato fra i blocchi di cartongesso
- ▶ Consente la realizzazione di una moderna luce di orientamento in combinazione con un allestimento della parete in linea con le soluzioni architettoniche
- ▶ Concepiti per elementi architettonici non portanti con cartongesso standard (12,5 mm) e orditura
- ▶ Possibilità di manutenzione: all'occorrenza il profilo può essere staccato a posteriori dai supporti
- ▶ Canalina per cavi supportata



#### Cup Profil 1m

⊕55,1 mm ⊗14 mm ⇔1 m

EAN 4000870 708583

**708.58** 📦

#### Cup Profil 2m

⊕55,1 mm ⊗14 mm ⇔2 m

EAN 4000870 708590

**708.59** 📦





- 🌀 Anodised aluminium
- 🔲 Aluminium/Plastic
- 🌀 Aluminio anodizado
- 🔲 Aluminio/Plástico
- 🌀 Alluminio anodizzato
- 🔲 Alluminio/Plastica

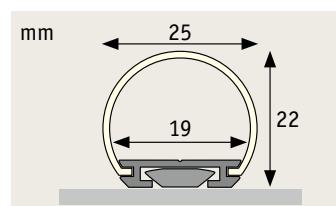

- ▶ 180° beam angle for fascinating light emission
- ▶ Captivating effect when combined with multi-coloured MaxLED RGBW strips
- ▶ Perfectly suited as a ceiling or wall luminaire
- ▶ A perfect match for the Shining Case (□ = 226)

- ▶ Salida de luz fascinante gracias al ángulo de irradiación de 180°
- ▶ Efecto fascinante en caso de combinación con strips MaxLED RGBW de colores
- ▶ Óptimo como luminaria de techo o de pared
- ▶ Perfecto para combinar con el Shining Case (□ = 226).

- ▶ Affascinante emissione della luce con un angolo di diffusione di 180°
- ▶ Effetto avvincente nella combinazione con MaxLED Strips colorate RGBW
- ▶ Ideali come plafoniere o appliques
- ▶ Perfetti in combinazione con lo Shining Case (□ = 226).



#### Tube Profil 1m

↕ 25 mm ø 25 mm ↗ 25 mm ↔ 1 m

EAN 4000870 705599

**705.59**

ALU  
rost  
frei

#### Tube Profil 2m

↕ 22 mm ø 25 mm ↗ 22 mm ↔ 2 m

EAN 4000870 705605

**705.60**

ALU  
rost  
frei







- 🌀 Anodised aluminium/Satin
- 🔲 Aluminium/Plastic
- 🌀 Aluminio anodizado/Satinado
- 🔲 Aluminio/Plástico
- 🌀 Alluminio anodizzato/Satinato
- 🔲 Alluminio/Plastica

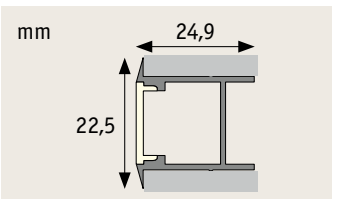
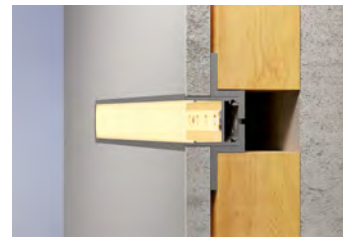

- ▶ Recessed profile in the thickness of plasterboard for lighting with LED strips
- ▶ Deep positioning of light point for uniform profile lighting also possible with low-loaded strips
- ▶ Designed for dry walls with standard plasterboard panels (12.5mm) and stud frames
- ▶ Serviceable: the profile can later be removed from the holders as required
- ▶ The cable guides are supported

- ▶ Perfil empotrado en cartón yeso grosor para la iluminación con LED Strips
- ▶ Punto de luz profundo para una iluminación uniforme del perfil incluso con strips poco equipadas
- ▶ Concebido para sistemas de construcción en seco con paneles de cartón yeso estándar (12,5 mm) y estructuras de celosía
- ▶ Permite el mantenimiento: si es necesario, el perfil se puede separar posteriormente de los soportes
- ▶ Permite guías de cables

- ▶ Profilo da incasso in cartongesso spessore per illuminazione di Strips LED
- ▶ Punto luce profondo per un'illuminazione uniforme dei profili, anche con Strips allestite in modo ridotto
- ▶ Concepiti per elementi architettonici non portanti con cartongesso standard (12,5 mm) e orditura
- ▶ Possibilità di manutenzione: all'occorrenza il profilo può essere staccato a posteriori dai supporti
- ▶ Canalina per cavi supportata



#### Deep Profil 1m

↕27 mm ↗33 mm ↔1 m  
 EAN 4000870 708606  
**708.60** ➡

#### Deep Profil 2m

↕27 mm ↗33 mm ↔2 m  
 EAN 4000870 708613  
**708.61** ➡





🌀 Blue/Green/Orange/Fuchsia 🏠 Plastic  
 🌀 Azul/Verde/Naranja/Rosa 🏠 Plástico  
 🌀 Blu/Verde/Arancione/Fucsia 🏠 Plastica

- ▶ Bend and fold – LED strips that maintain their shape
- ▶ Great, homogeneous neon light effect
- ▶ New: with impressive, controllable RGB colours (70557)
- ▶ With USB plug – compatible with powerbanks, laptops, wall socket adapters, etc.
- ▶ 5 transparent retaining clips for e.g. wall mounting included
- ▶ Doblar y plegar: strips LED que mantienen la forma
- ▶ Fantástico efecto neón homogéneo
- ▶ Novedad: con impresionantes colores RGB regulables (70557)
- ▶ Con conector USB: compatible con power banks, ordenadores portátiles, adaptadores, etc.
- ▶ Incl. 5 clips de sujeción transparentes, p. ej., para montaje en la pared
- ▶ Pieghevoli - Strip LED che mantengono la forma
- ▶ Fantastico effetto di luce neon omogeneo
- ▶ Novità: con meravigliosi colori RGB comandabili (70557)
- ▶ Con connettore USB –compatibile con power bank, laptop, adattatori per prese ecc.
- ▶ Incl. 5 clip trasparenti, ad es. per montaggio a parete

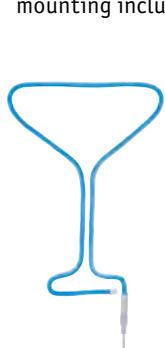

**Neon Colorflex USB Strip Blue**

incl. 1x4,5 W  
 10 lm  
 DC 5 V  
 ⚙️12 mm ⚙️6 mm ⇄1 m  
 EAN 4000870 705643  
**705.64** 🏠



**Neon Colorflex USB Strip Orange**

incl. 1x4,5 W  
 10 lm  
 DC 5 V  
 ⚙️12 mm ⚙️6 mm ⇄1 m  
 EAN 4000870 705629  
**705.62** 🏠



**Neon Colorflex USB Strip Green**

incl. 1x4,5 W  
 10 lm  
 DC 5 V  
 ⚙️12 mm ⚙️6 mm ⇄1 m  
 EAN 4000870 705636  
**705.63** 🏠



**Neon Colorflex USB Strip Pink**

incl. 1x4,5 W  
 10 lm  
 DC 5 V  
 ⚙️12 mm ⚙️6 mm ⇄1 m  
 EAN 4000870 705612  
**705.61** 🏠

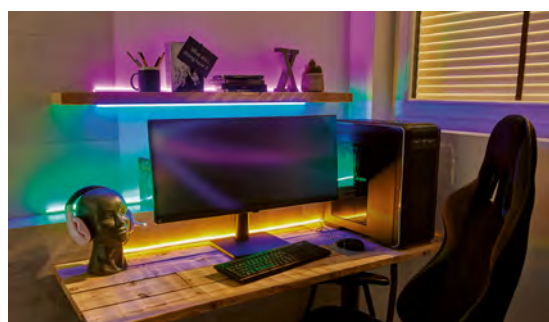

**Neon Colorflex USB Stripe mixed box**

incl. 4x4,5 W  
 4x10 lm  
 DC 5 V  
 ⚙️12 mm ⚙️6 mm ⇄1 m  
 EAN 4000870 705582  
**705.58** 🏠

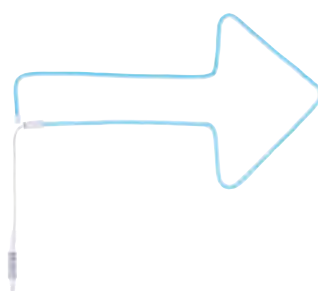

**Colorflex RGB**

incl. 1x5 W  
 10 lm  
 DC 5 V  
 ⇄85 mm ⚙️14 mm ⇄1 m  
 EAN 4000870 705575  
**705.57** 🏠





- ▣ Elastic textile/Plastic
- ▣ Material textil elástico/Plástico
- ▣ tessuto elastico/Plastica

- ▶ Belt bag incl. LED light
- ▶ The stretch fabric is weather-resistant and rain-resistant.
- ▶ The pocket fits all common smart phones
- ▶ Battery life approx. 3 hrs.
- ▶ Charging time approx. 1 hour

- ▶ Riñonera con luz LED
- ▶ El tejido elástico es resistente a la intemperie y repele la lluvia
- ▶ Bolsillo apropiado para todos los smartphones corrientes
- ▶ Autonomía de la batería aprox. 3 horas
- ▶ Tiempo de carga aprox. 1 hora

- ▶ Marsupio con LED incluso
- ▶ Il tessuto stretch è resistente alle intemperie
- ▶ La tasca è adatta ai comuni smartphone
- ▶ Tempo di carica batteria ca. 3 h
- ▶ Tempo di carica ca. 1 h



**Waist bag red rechargeable**

incl. 1x0,4 W  
 DC 5 V  
 ⌀40 ⇄930 ↗20 mm  
 EAN 4000870 709689  
**709.68** 📦



**Waist bag yellow rechargeable**

incl. 1x0,4 W  
 DC 5 V  
 ⌀40 ⇄930 ↗20 mm  
 EAN 4000870 709696  
**709.69** 📦





Plastic  
 Plástico  
 Plastica



**USB-Light Stick 22cm**

incl. 1x0,5 W  
 50 lm, 6.500 K  
 DC 5 V  
 ⌀9 ⇔220 ↻18 mm  
 EAN 4000870 708866  
**708.86**



**USB-Light Stick 22cm**

incl. 1x0,5 W  
 50 lm, 6.500 K  
 DC 5 V  
 ⌀9 ⇔220 ↻18 mm  
 EAN 4000870 708859  
**708.85**

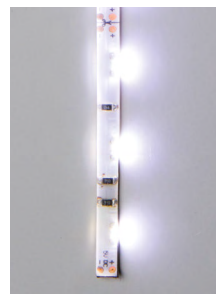

White  Metal/Plastic  
 Blanco  Metal/Plástico  
 Bianco  Metallo/Plastica



**USB-Strip Daylight 30cm**

incl. 1x1,5 W  
 60 lm, 6.000 K  
 ⌀2,5 mm ⇔300 mm ↻5 mm ⇔0,3 m  
 EAN 4000870 704554  
**704.55**



**USB-Strip Blue 30cm**

incl. 1x1,5 W  
 ⌀3 mm ⇔300 mm ↻5 mm ⇔0,3 m  
 EAN 4000870 704561  
**704.56**



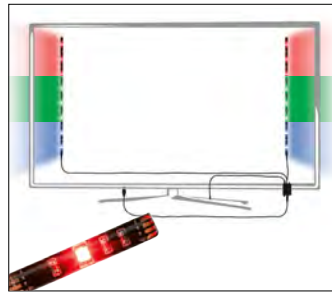

- ↳ Black Metal/Plastic
- ↳ Negro Metal/Plástico
- ↳ Nero Metallo/Plastica



**USB-Strip RGB 2x50cm**

incl. 2x1,25 W  
 2x40 lm  
 <math>\sphericalangle 120^\circ</math>  
 1xCR 2025/3V  
 $\varnothing 3\text{ mm} \leftrightarrow 500\text{ mm} \varnothing 10\text{ mm} \leftrightarrow 0,5\text{ m}$   
 EAN 4000870 707067  
**707.06**



**USB-Strip Warm white 2x50cm**

incl. 2x2,2 W  
 2x100 lm, 3.000 K  
 $\varnothing 3\text{ mm} \leftrightarrow 500\text{ mm} \varnothing 10\text{ mm} \leftrightarrow 0,5\text{ m}$   
 EAN 4000870 707050  
**707.05**

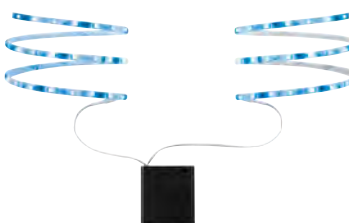

**Mobil Strip (4x1,5V AA excl.)**

incl. 2x0,9 W  
 2x95 lm, 2.700 K  
 4xAA/1,5 V (Mignon)  
 $\varnothing 3\text{ mm} \leftrightarrow 800\text{ mm} \varnothing 5\text{ mm} \leftrightarrow 0,8\text{ m}$   
 EAN 4000870 707012  
**707.01**



**Mobil Strip Blue (4x1,5V AA excl.)**

incl. 2x0,6 W  
 2x8 lm  
 4xAA/1,5 V (Mignon)  
 $\varnothing 3\text{ mm} \leftrightarrow 800\text{ mm} \varnothing 5\text{ mm} \leftrightarrow 0,8\text{ m}$   
 EAN 4000870 707029  
**707.02**



**Mobil Strip RGB (4x1,5V AA excl.)**

incl. 2x1,2 W  
 2x28 lm  
 4xAA/1,5 V (Mignon)  
 $\varnothing 3\text{ mm} \leftrightarrow 800\text{ mm} \varnothing 5\text{ mm} \leftrightarrow 0,8\text{ m}$   
 EAN 4000870 707005  
**707.00**



- ↳ White Metal/Plastic
- ↳ Blanco Metal/Plástico
- ↳ Bianco Metallo/Plastica

- ↳ White Metal/Plastic
- ↳ Blanco Metal/Plástico
- ↳ Bianco Metallo/Plastica

- ↳ White Metal/Plastic
- ↳ Blanco Metal/Plástico
- ↳ Bianco Metallo/Plastica



# Assistance

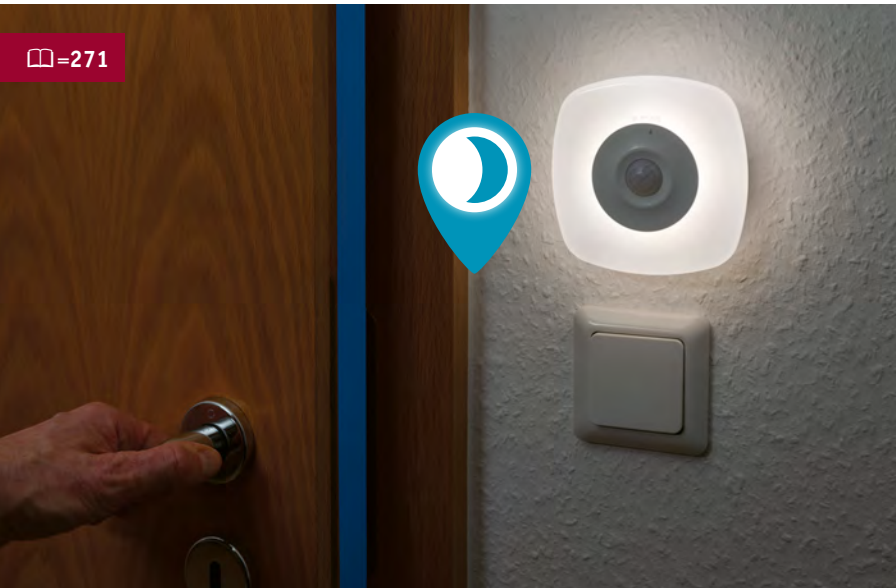



**FlexLink**

incl. 1x4,5 W  
530 lm, 2.700 - 6.000 K  
2x18650 Akku/3,7V  
DC 5 V  
422 ⇄ 235 ↗ 236 mm  
EAN 4000870 954232  
**954.23**



 **tunable white**



White Aluminium/Plastic/Silicone  
Blanco Aluminio/Plástico/Silicona  
Bianco Alluminio/Plastica/Silicone

**FlexLink**

incl. 1x4,5 W  
530 lm, 2.700 - 6.000 K  
2x18650 Akku/3,7V  
DC 5 V  
422 ⇄ 235 ↗ 236 mm  
EAN 4000870 954249  
**954.24**



 **tunable white**



Black Aluminium/Plastic/Silicone  
Negro Aluminio/Plástico/Silicona  
Nero Alluminio/Plastica/Silicone

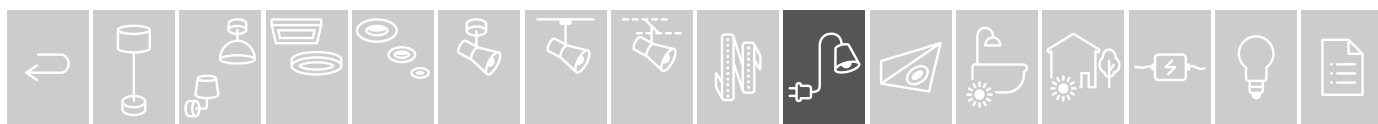



**Zed LED**

incl. 1x5 W  
630 lm, 3.000 K  
230 V  
475 ø160 mm  
EAN 4000870 702451

**702.45**

- 🔩 Brushed iron 🏠 Metal
- 🔩 Hierro mateado 🏠 Metal
- 🔩 Ferro spazzolato 🏠 Metallo

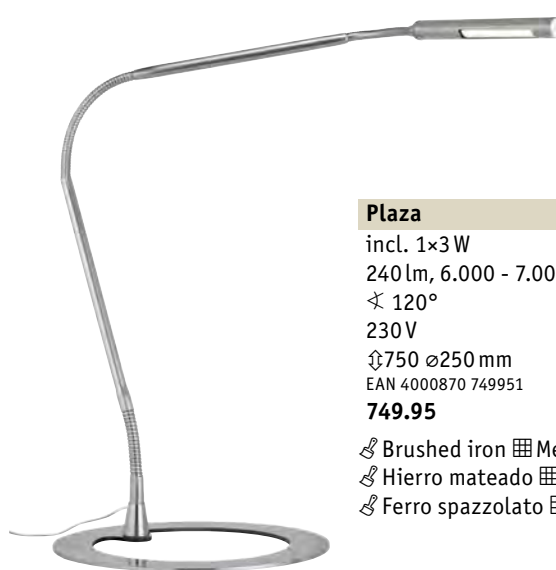

**Plaza**

incl. 1x3 W  
240 lm, 6.000 - 7.000 K  
120°  
230 V  
750 ø250 mm  
EAN 4000870 749951

**749.95**

- 🔩 Brushed iron 🏠 Metal
- 🔩 Hierro mateado 🏠 Metal
- 🔩 Ferro spazzolato 🏠 Metallo

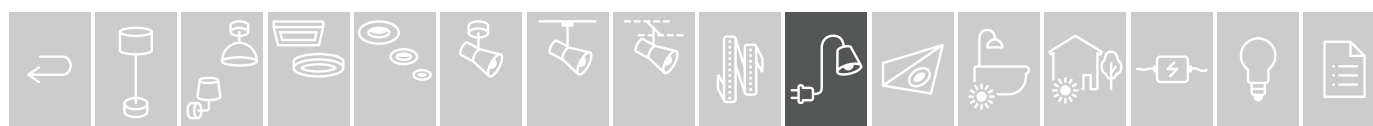





- 🔊 White 📦 Plastic
- 🔊 Blanco 📦 Plástico
- 🔊 Bianco 📦 Plastica



**Viby**

incl. 1x0,7 W  
60 lm, 3.000 K  
3xAA-Akku/1,5V  
(Mignon)  
⌀110 ⇄110 ⚡37 mm  
EAN 4000870 924914  
**924.91** 📦



**Viby**

incl. 1x0,7 W  
56 lm, 3.000 K  
3xAA-Akku/1,5V  
(Mignon)  
⌀120 ⚡40 mm  
EAN 4000870 924921  
**924.92** 📦



- 🔊 White 📦 Plastic
- 🔊 Blanco 📦 Plástico
- 🔊 Bianco 📦 Plastica



**Esby**

incl. 1x0,016 W  
3 lm, 3.000 K  
230 V  
⌀80 ⇄80 ⚡58 mm  
EAN 4000870 924938  
**924.93** 📦



**Esby**

incl. 1x0,2 W  
30 lm, 3.000 K  
230 V  
⌀90 ⚡70 mm  
EAN 4000870 924945  
**924.94** 📦



- 🔊 White 📦 Plastic
- 🔊 Blanco 📦 Plástico
- 🔊 Bianco 📦 Plastica



**Horby**

incl. 1x0,4 W  
56 lm, 3.000 K  
230 V  
⌀90 ⚡68 mm  
EAN 4000870 924952  
**924.95** 📦

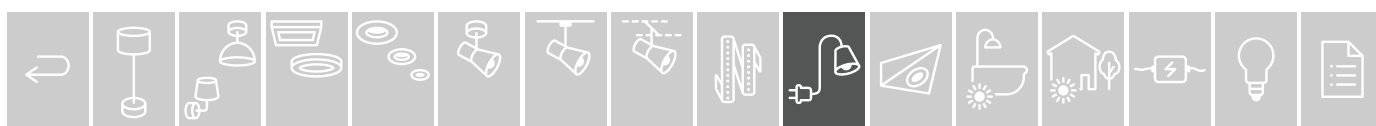









 Perfect match  
 □ = 407-408  
 416



**Vitis**







max. 20W, E14  
 230V  
 ⚡370 ø110 mm  
 EAN 4000870 954324  
**954.32** 

-  Grey  Metal/Plastic
-  Gris  Metal/Plástico
-  Grigio  Metallo/Plastica



**Vitis**







max. 20W, E14  
 230V  
 ⚡370 ø110 mm  
 EAN 4000870 954317  
**954.31** 

-  White  Metal/Plastic
-  Blanco  Metal/Plástico
-  Bianco  Metallo/Plastica



**Vitis**







max. 20W, E14  
 230V  
 ⚡370 ø110 mm  
 EAN 4000870 954300  
**954.30** 

-  Black  Metal/Plastic
-  Negro  Metal/Plástico
-  Nero  Metallo/Plastica



**Assistent Gryps**

max. 40W, E14  
 230V  
 ⚡150 ø60 ↔115 mm  
 EAN 4000870 998250  
**998.25** 

-  Brushed iron  Metal/Plastic
-  Hierro mateado  Metal/Plástico
-  Ferro spazzolato  Metallo/Plastica





**Assistent Finja LED**

max. 35 W, GU10  
230 V  
∅330 ∅51 ⇄115 mm  
EAN 4000870 954263

**954.26**

- 🔗 Chrome matt 🏠 Metal/Plastic
- 🔗 Cromo mate 🏠 Metal/Plástico
- 🔗 Cromo opaco 🏠 Metallo/Plastica



**Assistent Gesa LED**

max. 35 W, GU10  
230 V  
∅285 ∅51 ⇄115 mm  
EAN 4000870 954256

**954.25**

- 🔗 Chrome matt 🏠 Metal/Plastic
- 🔗 Cromo mate 🏠 Metal/Plástico
- 🔗 Cromo opaco 🏠 Metallo/Plastica

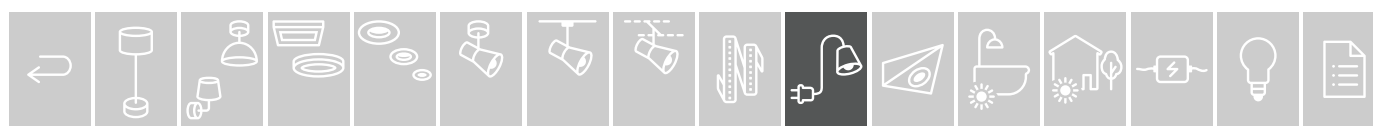



Perfect match

□ = 407-408  
416



**Junus**

max. 20 W, E14  
230 V  
∅390 ∅110 mm  
EAN 4000870 954294  
**954.29**



🌀 Grey 🗪 Metal/Plastic  
🌀 Gris 🗪 Metal/Plástico  
🌀 Grigio 🗪 Metallo/Plastica



**Junus**

max. 20 W, E14  
230 V  
∅390 ∅110 mm  
EAN 4000870 954287  
**954.28**



🌀 White 🗪 Metal/Plastic  
🌀 Blanco 🗪 Metal/Plástico  
🌀 Bianco 🗪 Metallo/Plastica



**Junus**

max. 20 W, E14  
230 V  
∅390 ∅110 mm  
EAN 4000870 954270  
**954.27**



🌀 Black 🗪 Metal/Plastic  
🌀 Negro 🗪 Metal/Plástico  
🌀 Nero 🗪 Metallo/Plastica

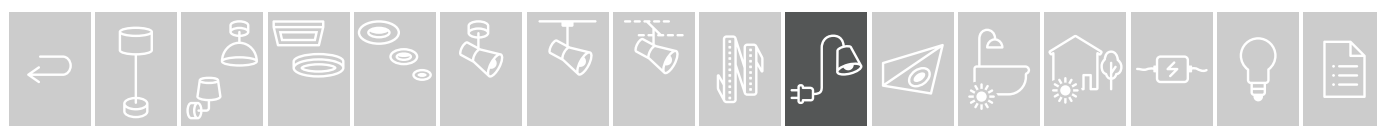

**Bento**

incl. 1×6 W  
600 lm, 3.000 K  
✗ 120°  
230 V  
⌀85 ⇄300 ↗120 mm  
EAN 4000870 955567

**955.56 new**

- 🔩 Brushed aluminium 📦 Metal/Plastic
- 🔩 Aluminio mateado 📦 Metal/Plástico
- 🔩 Alluminio spazzolato 📦 Metallo/Plastica

**Bento**

incl. 1×8,5 W  
900 lm, 3.000 K  
✗ 120°  
230 V  
⌀85 ⇄400 ↗120 mm  
EAN 4000870 955574

**955.57 new**

- 🔩 Brushed aluminium 📦 Metal/Plastic
- 🔩 Aluminio mateado 📦 Metal/Plástico
- 🔩 Alluminio spazzolato 📦 Metallo/Plastica

**Bento**

incl. 1×10 W  
1.050 lm, 3.000 K  
✗ 120°  
230 V  
⌀85 ⇄500 ↗120 mm  
EAN 4000870 955581

**955.58 new**

- 🔩 Brushed aluminium 📦 Metal/Plastic
- 🔩 Aluminio mateado 📦 Metal/Plástico
- 🔩 Alluminio spazzolato 📦 Metallo/Plastica

**Bento**

incl. 1×6 W  
600 lm, 3.000 K  
✗ 120°  
230 V  
⌀85 ⇄300 ↗120 mm  
EAN 4000870 955598

**955.59 new**

- 🔩 Old brass 📦 Metal/Plastic
- 🔩 Latón envejecido 📦 Metal/Plástico
- 🔩 Ottone brunito 📦 Metallo/Plastica

**Bento**

incl. 1×8,5 W  
900 lm, 3.000 K  
✗ 120°  
230 V  
⌀85 ⇄400 ↗120 mm  
EAN 4000870 955604

**955.60 new**

- 🔩 Old brass 📦 Metal/Plastic
- 🔩 Latón envejecido 📦 Metal/Plástico
- 🔩 Ottone brunito 📦 Metallo/Plastica

**Bento**

incl. 1×10 W  
1.050 lm, 3.000 K  
✗ 120°  
230 V  
⌀85 ⇄500 ↗120 mm  
EAN 4000870 955611

**955.61 new**

- 🔩 Old brass 📦 Metal/Plastic
- 🔩 Latón envejecido 📦 Metal/Plástico
- 🔩 Ottone brunito 📦 Metallo/Plastica

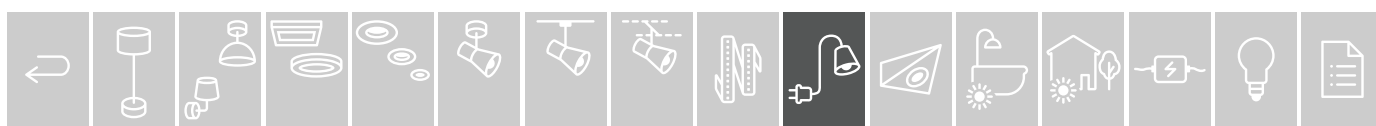

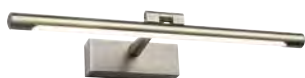

**Mingo**

incl. 1x9,5 W  
1.000 lm, 3.000 K  
∠ 120°  
230 V  
∅50 ⇔415 ∇175 mm  
EAN 4000870 955628

**955.62 new**

- 🔗 Old brass 📦 Metal/Plastic
- 🔗 Latón envejecido 📦 Metal/Plástico
- 🔗 Ottone brunito 📦 Metallo/Plastica



**Mingo**

incl. 1x9,5 W  
1.000 lm, 3.000 K  
∠ 120°  
230 V  
∅50 ⇔415 ∇175 mm  
EAN 4000870 955666

**955.66 new**

- 🔗 Brushed aluminium 📦 Metal/Plastic
- 🔗 Aluminio mateado 📦 Metal/Plástico
- 🔗 Alluminio spazzolato 📦 Metallo/Plastica



**Mingo**

incl. 1x9,5 W  
1.000 lm, 3.000 K  
∠ 120°  
230 V  
∅50 ⇔415 ∇175 mm  
EAN 4000870 955642

**955.64 new**

- 🔗 Black 📦 Metal/Plastic
- 🔗 Negro 📦 Metal/Plástico
- 🔗 Nero 📦 Metallo/Plastica

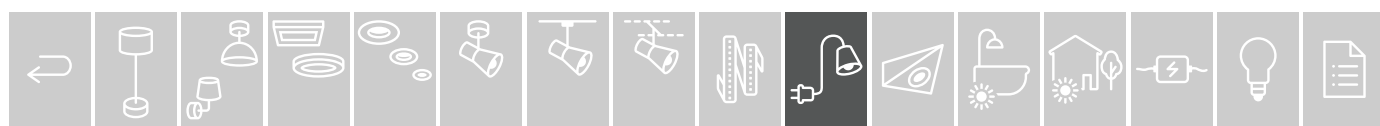

**Renan**

incl. 1x6 W  
600 lm, 3.000 K  
✗ 120°  
230 V  
⇅125 ⇄300 ↗210 mm  
EAN 4000870 955680

**955.68 new**

🌀 Old brass 📦 Metal/Acrylic  
🌀 Latón envejecido 📦 Metal/Acrílico  
🌀 Ottone brunito 📦 Metallo/Acricolo

**Renan**

incl. 1x9,5 W  
1.000 lm, 3.000 K  
✗ 120°  
230 V  
⇅125 ⇄400 ↗210 mm  
EAN 4000870 955697

**955.69 new**

🌀 Old brass 📦 Metal/Acrylic  
🌀 Latón envejecido 📦 Metal/Acrílico  
🌀 Ottone brunito 📦 Metallo/Acricolo

**Renan**

incl. 1x11 W  
1.250 lm, 3.000 K  
✗ 120°  
230 V  
⇅125 ⇄600 ↗210 mm  
EAN 4000870 955703

**955.70 new**

🌀 Old brass 📦 Metal/Acrylic  
🌀 Latón envejecido 📦 Metal/Acrílico  
🌀 Ottone brunito 📦 Metallo/Acricolo

**Renan**

incl. 1x6 W  
600 lm, 3.000 K  
✗ 120°  
230 V  
⇅125 ⇄300 ↗210 mm  
EAN 4000870 955710

**955.71 new**

🌀 Brushed aluminium 📦 Metal/Acrylic  
🌀 Aluminio mateado 📦 Metal/Acrílico  
🌀 Alluminio spazzolato 📦 Metallo/Acricolo

**Renan**

incl. 1x9,5 W  
1.000 lm, 3.000 K  
✗ 120°  
230 V  
⇅125 ⇄400 ↗210 mm  
EAN 4000870 955727

**955.72 new**

🌀 Brushed aluminium 📦 Metal/Acrylic  
🌀 Aluminio mateado 📦 Metal/Acrílico  
🌀 Alluminio spazzolato 📦 Metallo/Acricolo

**Renan**

incl. 1x11 W  
1.250 lm, 3.000 K  
✗ 120°  
230 V  
⇅125 ⇄600 ↗210 mm  
EAN 4000870 955734

**955.73 new**

🌀 Brushed aluminium 📦 Metal/Acrylic  
🌀 Aluminio mateado 📦 Metal/Acrílico  
🌀 Alluminio spazzolato 📦 Metallo/Acricolo

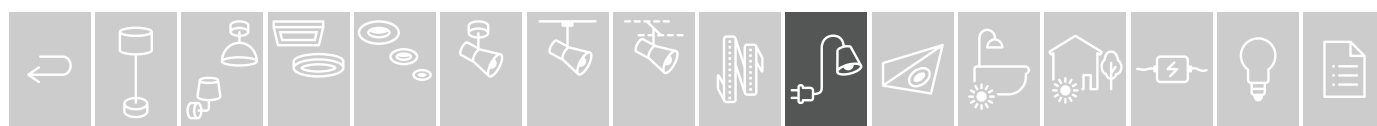



**Beam Fifty**

incl. 1x8 W  
850 lm, 2.700 K  
✗ 100°  
230 V  
⤴46 ⤵450 ⤶190 mm  
EAN 4000870 998892

- 🔩 Chrome 🏠 Metal
- 🔩 Cromo 🏠 Metal
- 🔩 Cromo 🏠 Metallo

**Beam Sixty**

incl. 1x11 W  
1,250 lm, 2.700 K  
✗ 100°  
230 V  
⤴46 ⤵585 ⤶190 mm  
EAN 4000870 998908

- 🔩 Chrome 🏠 Metal
- 🔩 Cromo 🏠 Metal
- 🔩 Cromo 🏠 Metallo



**Beam Thirty**

incl. 1x6 W  
630 lm, 2.700 K  
✗ 100°  
230 V  
⤴46 ⤵290 ⤶190 mm  
EAN 4000870 998915

- 🔩 White/Chrome 🏠 Metal
- 🔩 Blanco/Cromo 🏠 Metal
- 🔩 Bianco/Cromo 🏠 Metallo

**Beam Fifty**

incl. 1x8 W  
850 lm, 2.700 K  
✗ 100°  
230 V  
⤴46 ⤵450 ⤶190 mm  
EAN 4000870 998922

- 🔩 White/Chrome 🏠 Metal
- 🔩 Blanco/Cromo 🏠 Metal
- 🔩 Bianco/Cromo 🏠 Metallo

**Beam Sixty**

incl. 1x11 W  
1,250 lm, 2.700 K  
✗ 100°  
230 V  
⤴46 ⤵585 ⤶190 mm  
EAN 4000870 998939

- 🔩 White/Chrome 🏠 Metal
- 🔩 Blanco/Cromo 🏠 Metal
- 🔩 Bianco/Cromo 🏠 Metallo

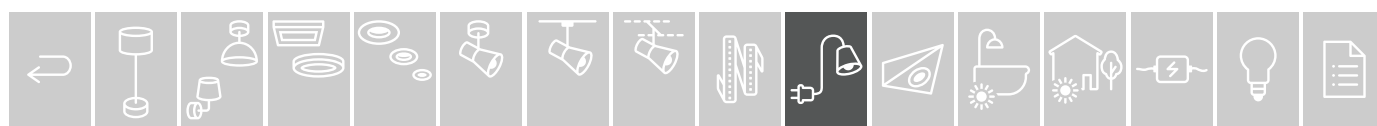





# Furniture

282 Clever Connect

290 Cabinet lights

301 Battery lights



## Clever Connect

Furniture illumination can be combined individually and expanded at any time with the Clever Connect system. The components are easily combined via plug connectors. Easy to attach – stick or screw on. The luminaires can be connected from one to the next or with the connector box on the transformer. All luminaires are dimmable and have tunable white capability – via the unique remote control. The magnetic holder transforms it into a wall switch.

El sistema Clever Connect permite combinar individualmente la iluminación de muebles y ampliarla en todo momento. Mediante los conectores resulta extremadamente fácil combinar los componentes. La fijación es sencilla: pegar o atornillar. La conexión se puede establecer de luminaria a luminaria o con la caja de conexión en el transformador. Todas las luminarias son regulables y aptas para la función de blanco ajustable con el exclusivo mando a distancia. Este también se puede utilizar como interruptor de pared gracias a su soporte magnético.

Con il sistema Clever Connect l'illuminazione di mobili può essere allestita in modo personalizzato e ampliata in qualsiasi momento. Attraverso connessioni a spina i componenti si possono abbinare fra loro in modo semplicissimo. Il fissaggio è semplice: basta incollare o avvitare. È possibile il collegamento da lampada a lampada o con l'apposita scatola sul trasformatore. Tutte le lampade sono dimmerabili e compatibili Tunable-White con il telecomando unico nel suo genere. Grazie al supporto magnetico il telecomando si può utilizzare come interruttore a parete.

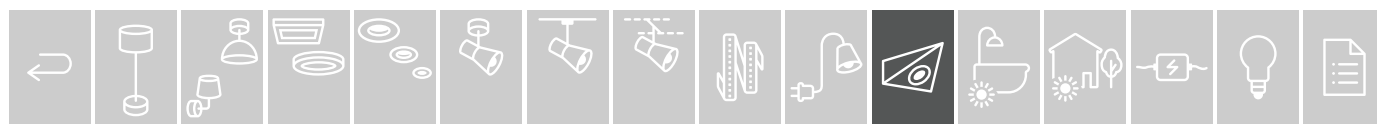



EN On top of the cabinet  
ES Encima del armario  
IT Sopra l'armadio



☰=282

Clever  Connect



☰=283

EN Inside the cabinet  
ES En el interior del armario  
IT Dentro l'armadio

EN Under a wall-mounted cabinet  
ES Debajo del armario de pared  
IT Sotto i pensili



☰=283



EN On the cabinet base  
ES En el zócalo del armario  
IT Nello zoccolo

EN POS concept – high variety range with little space requirements  
ES Concepto de punto de venta: un amplio surtido en una superficie pequeña  
IT Concetto POS: l'assortimento è concentrato su una piccola superficie

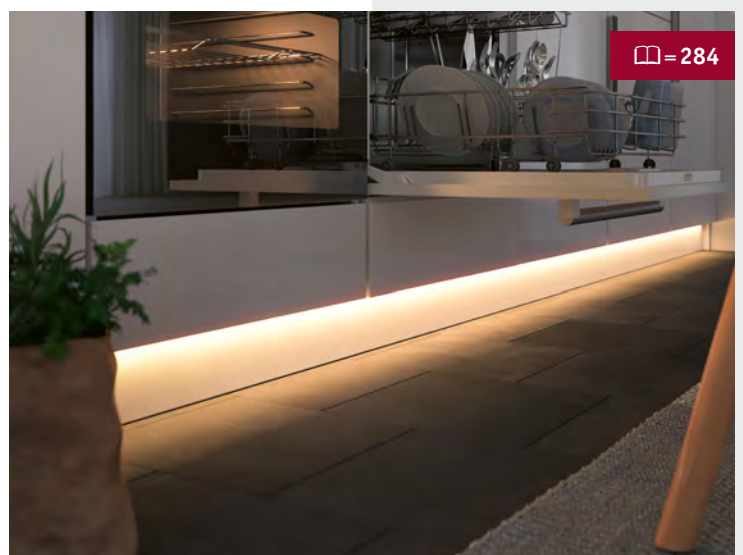



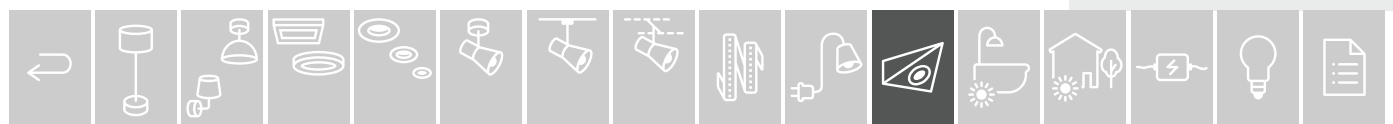



☰=284







  
**tunable white**  
 only with  
 999.76  = 289



-  Matt white  Plastic
-  Blanco mate  Plástico
-  Bianco opaco  Plastica





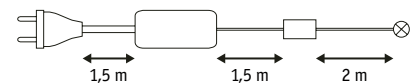

  
**tunable white**  
 only with 999.76  
 = 289

**Clever Connect Starter Set Mike**

incl. 2x2 W  
 2x195 lm, 2.700 - 6.500 K  
 230/12 V, incl.  12 VA  
 ⌀35 ⇄70 ⌀245 mm  
 EAN 4000870 999738  
**999.73** 











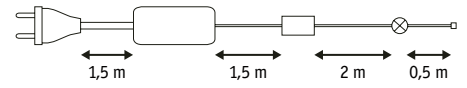

-  Brushed nickel  Metal
-  Níquel mateado  Metal
-  Nichel spazzolato  Metallo

  
**tunable white**  
 only with **999.76**  
 = 289

**Clever Connect Starter Set Trigo**



incl. 3×2,1W  
 3×190 lm, 2.700 - 6.500 K  
 230/12 V, incl.  12 VA  
 ⌀45 ⇄124 ↗141 mm  
 EAN 4000870 999745  
**999.74** 



-  Matt white  Plastic
-  Blanco mate  Plástico
-  Bianco opaco  Plastica

  
**tunable white**  
 only with **999.76**  
 = 289

**Clever Connect Starter Set Disc**

incl. 3×2,1W  
 3×175 lm, 2.700 - 6.500 K  
 230/12 V, incl.  12 VA  
 ⌀17 ø65 mm  
 EAN 4000870 999752  
**999.75** 

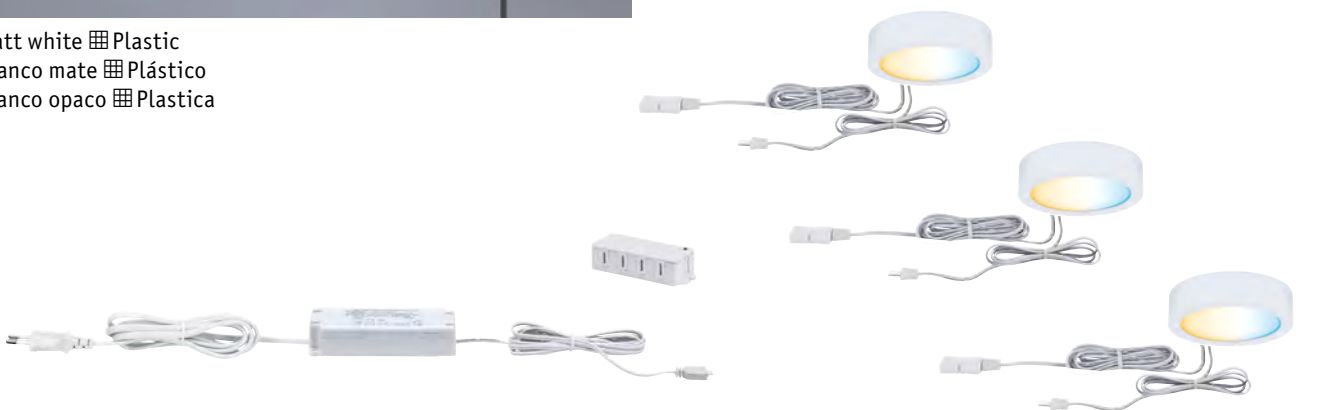
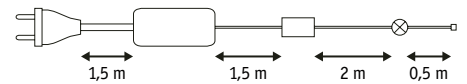









  
**tunable white**  
 only with 999.76  
 □ = 289



**Clever Connect Spot Mike**

incl. 1x2 W  
 195 lm, 2.700 - 6.500 K  
 12 V  
 ⚡35 ↔70 ↗245 mm  
 EAN 4000870 999493  
**999.49** 









-  Matt white  Plastic
-  Blanco mate  Plástico
-  Bianco opaco  Plastica

**Clever Connect Spot Mike**

incl. 1x2 W  
 195 lm, 2.700 - 6.500 K  
 12 V  
 ⚡35 ↔70 ↗245 mm  
 EAN 4000870 999509  
**999.50** 



-  Chrome matt  Plastic
-  Cromo mate  Plástico
-  Cromo opaco  Plastica









  
**tunable white**  
 only with 999.76  
 □ = 289



**Clever Connect Stripe 1m**

incl. 1x6,5 W  
 550 lm, 2.700 - 6.500 K  
 12 V  
 ↔1.000 ↗12,5 mm  
 EAN 4000870 999721  
**999.72** 



-  Transparent  Plastic
-  Transparente  Plástico
-  Trasparente  Plastica

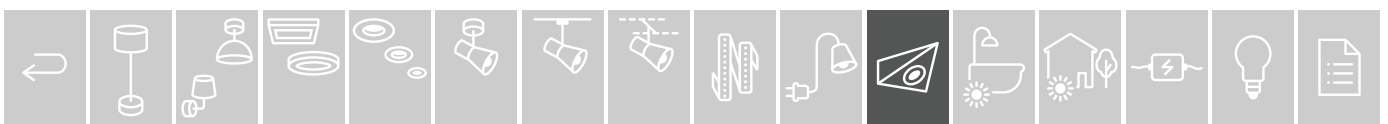









  
**tunable white**  
 only with 999.76  
 □=289









**Clever Connect Spot Disc**

incl. 1x2,1 W  
 175 lm, 2.700 - 6.500 K  
 12 V  
 ⚡17 ⌀65 mm  
 EAN 4000870 999523  
**999.52** 

-  Matt white  Plastic
-  Blanco mate  Plástico
-  Bianco opaco  Plastica

**Clever Connect Spot Disc**

incl. 1x2,1 W  
 175 lm, 2.700 - 6.500 K  
 12 V  
 ⚡17 ⌀65 mm  
 EAN 4000870 999530  
**999.53** 

-  Chrome matt  Plastic
-  Cromo mate  Plástico
-  Cromo opaco  Plastica









  
**tunable white**  
 only with 999.76  
 □=289









**Clever Connect Spot Medal**

incl. 1x2,3 W  
 155 lm, 2.700 - 6.500 K  
 12 V  
 ⚡15 ⌀43 mm  
 EAN 4000870 999547  
**999.54** 

-  Matt white  Plastic
-  Blanco mate  Plástico
-  Bianco opaco  Plastica

**Clever Connect Spot Medal**

incl. 1x2,3 W  
 155 lm, 2.700 - 6.500 K  
 12 V  
 ⚡15 ⌀43 mm  
 EAN 4000870 999554  
**999.55** 

-  Chrome matt  Plastic
-  Cromo mate  Plástico
-  Cromo opaco  Plastica





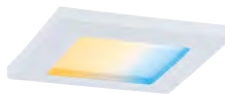



  
**tunable white**  
 only with 999.76  
 □=289









**Clever Connect Spot Pola**

incl. 1x2,5 W  
 145 lm, 2.700 - 6.500 K  
 12 V  
 ⚡4 ⇄70 ⇄70 mm  
 EAN 4000870 999615  
**999.61** 

-  Matt white  Plastic
-  Blanco mate  Plástico
-  Bianco opaco  Plastica

**Clever Connect Spot Pola**







incl. 1x2,5 W  
 145 lm, 2.700 - 6.500 K  
 12 V  
 ⚡4 ⇄70 ⇄70 mm  
 EAN 4000870 999608  
**999.60** 

-  Chrome matt  Plastic
-  Cromo mate  Plástico
-  Cromo opaco  Plastica





  
**tunable white**  
 only with 999.76  
 □ = 289

-  Matt white  Plastic
-  Blanco mate  Plástico
-  Bianco opaco  Plastica



**Clever Connect Spot Border 300mm**

incl. 1x5 W  
 460 lm, 2.700 - 6.500 K  
 12 V  
 ⌀8 ↔300 ↗38 mm  
 EAN 4000870 999622  
**999.62** 



**Clever Connect Spot Border 500mm**

incl. 1x7,5 W  
 700 lm, 2.700 - 6.500 K  
 12 V  
 ⌀8 ↔500 ↗38 mm  
 EAN 4000870 999639  
**999.63** 



**Border Edge-Connector**

12 V  
 ⌀50 ↗50 mm  
 EAN 4000870 999646  
**999.64** 



**Border T-Connector**

12 V  
 ⌀50 ↗50 mm  
 EAN 4000870 999653  
**999.65** 



**Border X-Connector**

12 V  
 ⌀50 ↗50 mm  
 EAN 4000870 999660  
**999.66** 



**Border Wall-Connector**

12 V  
 ⌀38 ↔24 ↗24 mm  
 EAN 4000870 999677  
**999.67** 



**Border Line-Connector**







12 V  
 ⌀37 ↗20 mm  
 EAN 4000870 999929  
**999.92**







  
**tunable white**  
 only with 999.76  
 □=289

 Chrome matt  Plastic  
 Cromo mate  Plástico  
 Cromo opaco  Plastica



**Clever Connect Spot Barre 350mm**

incl. 1x3,5 W  
 330 lm, 2.700 - 6.500 K  
 12 V  
 ⌀10 ⇄350 ↗25 mm  
 EAN 4000870 999684  
**999.68** 



**Clever Connect Spot Barre 500mm**

incl. 1x6,5 W  
 610 lm, 2.700 - 6.500 K  
 12 V  
 ⌀10 ⇄550 ↗25 mm  
 EAN 4000870 999691  
**999.69** 



**Barre Edge-Connector**

12 V  
 ⌀10 ⇄50 ↗50 mm  
 EAN 4000870 999707  
**999.70** 



**Barre Line-Connector**

12 V  
 ⌀10 ⇄50 ↗25 mm  
 EAN 4000870 999714  
**999.71** 



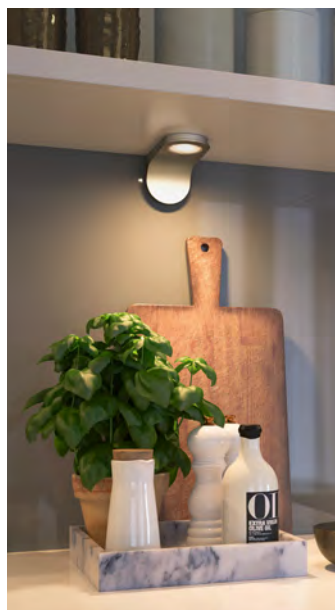







  
**tunable white**  
 only with 999.76  
 □=289









**Clever Connect Spot Neda**

incl. 1x2,1 W  
 180 lm, 2.700 - 6.500 K  
 12 V  
 ⌀70 ⇄64 ⌀151 mm  
 EAN 4000870 999578  
**999.57** 

-  Matt white  Plastic
-  Blanco mate  Plástico
-  Bianco opaco  Plastica

**Clever Connect Spot Neda**

incl. 1x2,1 W  
 180 lm, 2.700 - 6.500 K  
 12 V  
 ⌀70 ⇄64 ⌀151 mm  
 EAN 4000870 999561  
**999.56** 

-  Chrome matt  Plastic
-  Cromo mate  Plástico
-  Cromo opaco  Plastica

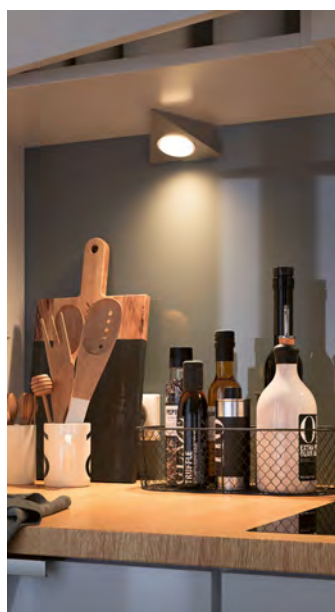



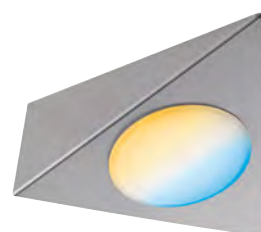
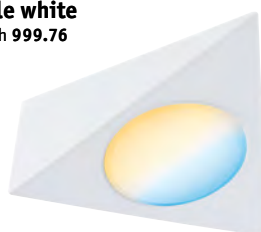



  
**tunable white**  
 only with 999.76  
 □=289









**Clever Connect Spot Trigo**

incl. 1x2,1 W  
 190 lm, 2.700 - 6.500 K  
 12 V  
 ⌀45 ⇄124 ⌀141 mm  
 EAN 4000870 999592  
**999.59** 

-  Matt white  Metal
-  Blanco mate  Metal
-  Bianco opaco  Metallo

**Clever Connect Spot Trigo**

incl. 1x2,1 W  
 190 lm, 2.700 - 6.500 K  
 12 V  
 ⌀45 ⇄124 ⌀141 mm  
 EAN 4000870 999585  
**999.58** 

-  Brushed nickel  Metal
-  Níquel mateado  Metal
-  Nichel spazzolato  Metallo





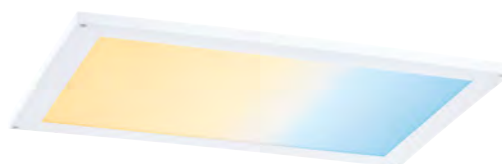



  
**tunable white**  
 only with 999.76  
 □=289







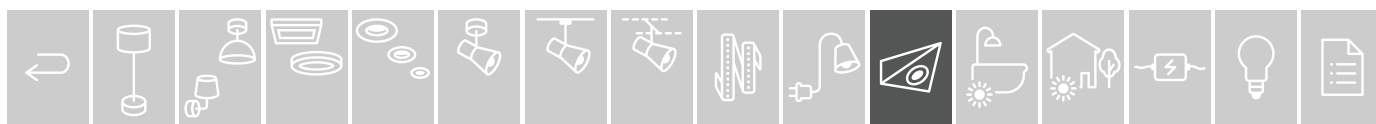

**Clever Connect Panel Flad**

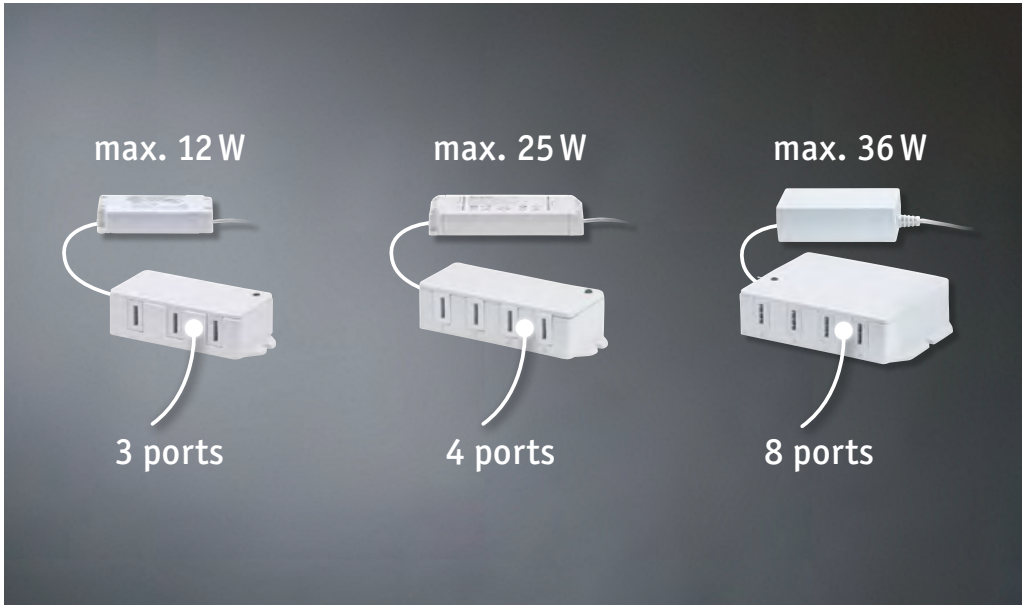
incl. 1x6 W  
 600 lm, 2.700 - 6.500 K  
 12 V  
 ⌀7,6 ⇄200 ⌀300 mm  
 EAN 4000870 999516  
**999.51** 

-  Matt white  Plastic
-  Blanco mate  Plástico
-  Bianco opaco  Plastica







 White  Plastic  
 Blanco  Plástico  
 Bianco  Plastica





**Clever Connect Driver**

max. 12 W  
 230/12 V, incl.  12 VA  
 ⌀18 ↔72 ↗31 mm  
 EAN 4000870 999462  
**999.46** 





**Clever Connect Driver**

max. 25 W  
 230/12 V, incl.  25 VA  
 ⌀19 ↔81 ↗30 mm  
 EAN 4000870 999479  
**999.47** 



**Clever Connect Driver**

max. 36 W  
 230/12 V, incl.  36 VA  
 ⌀19 ↔82 ↗54 mm  
 EAN 4000870 999486  
**999.48** 





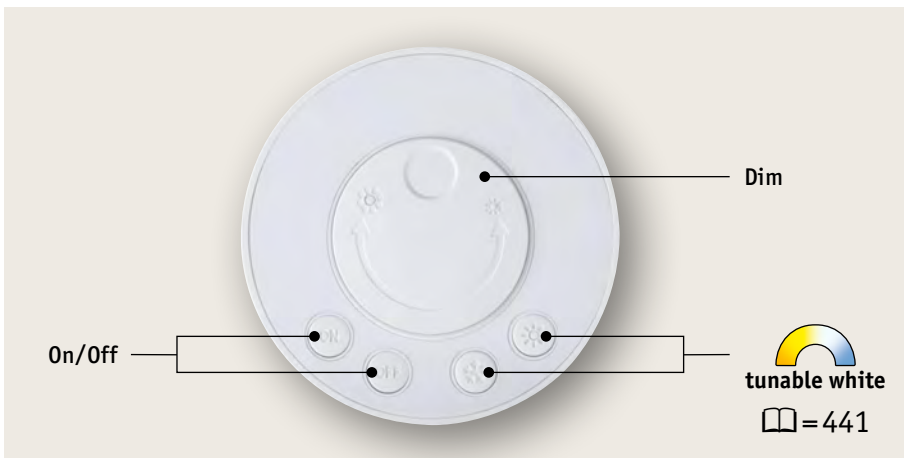



Remote Control  
 incl. memory function



**Clever Connect Switch Bowl**

1xCR2450  
 ⌀23 ⌀71 mm  
 EAN 4000870 999769  
**999.76** 



 Matt white  Plastic  
 Blanco mate  Plástico  
 Bianco opaco  Plastica

► Tunable white in every luminaire – remote control, can also be used as wall switch

► Tunable white en cada luminaria; control a través del mando a distancia, utilizable también como interruptor de pared

► Tunable white in ogni lampada: comando tramite telecomando, utilizzabile anche come interruttore a parete





Under-cabinet luminaires for optimum illumination of work surfaces in the kitchen, wall cabinets and shelf units etc.

Luminarias para la instalación debajo de armarios para la iluminación óptima, p. ej., de áreas de trabajo en la cocina, armarios empotrados o estanterías.

Lampade sottopensili per illuminazione ottimale, ad es. di aree di lavoro in cucina, pensili o scaffali.



**Furniture LED Leaf**

Aluminium Aluminium Alluminio



Brushed aluminium Aluminium mateado Alluminio spazzolato

**incl. 3x4,7 W**  
 3x310 lm, 2.700 K  
 <math>\angle 120^\circ</math>  
 230/12 V, incl. <math>-15 VA</math>  
 EAN 4000870 935613  
**935.61**

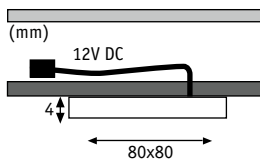

Brushed aluminium Aluminium mateado Alluminio spazzolato

**incl. 3x4 W**  
 3x280 lm, 2.700 K  
 <math>\angle 120^\circ</math>  
 230/12 V, incl. <math>-12 VA</math>  
 EAN 4000870 935620  
**935.62**

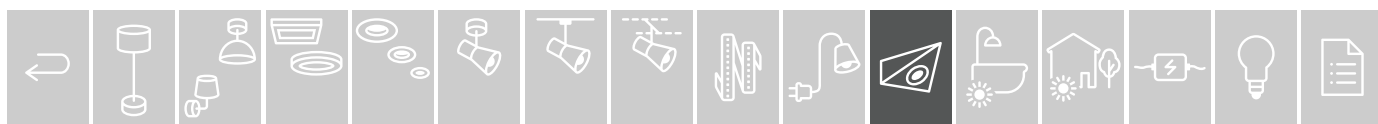
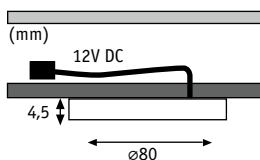

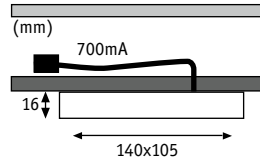

**Furniture LED Vane**

Aluminium Aluminio Alluminio



Matt white Blanco mate Bianco opaco

**incl. 1x6,7 W**

450 lm, 2.700 K  
230/12 V, incl. 8 VA  
EAN 4000870 920329  
**920.32**

**incl. 2x6,7 W**

2x450 lm, 2.700 K  
230/12 V, incl. 15 VA  
EAN 4000870 935835  
**935.83**

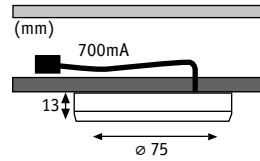

**Furniture LED Unity**

Metal/Acrylic Metal/Acrílico Metallo/Acrylico



Brushed iron Hierro mateado Ferro spazzolato

**incl. 3x4,5 W**

3x360 lm, 2.700 K  
∠ 120°  
230 V, incl. 15 VA  
EAN 4000870 935644  
**935.64**



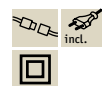
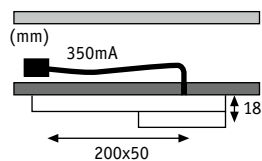

**Furniture LED Setup**

☒ Metal/Acrylic Metal/Acrílico Metallo/Acricico



☞ Brushed iron Hierro mateado Ferro spazzolato

**incl. 3x3,2 W**

3x250 lm, 2.700 K

☞ 120°

230 V, incl. ⚡ 15 VA

EAN 4000870 935675

**935.67**

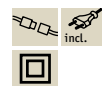
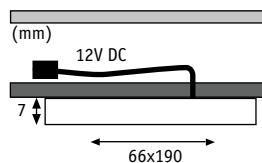

**Furniture LED Pattern**

☒ Plastic Plástico Plastica



☞ Chrome matt Cromo mate Cromo opaco

**incl. 3x2,2 W**

3x160 lm, 2.700 K

☞ 70°

230/12 V, incl. ⚡ 12 VA

EAN 4000870 935637

**935.63**

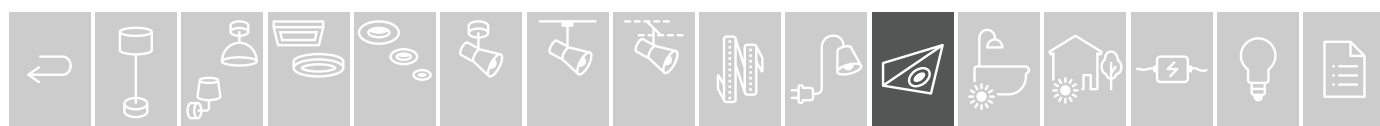

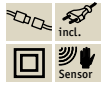
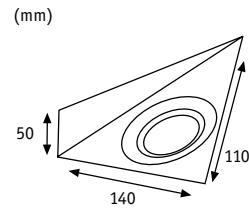

**Furniture LED Triangle Sensor** Metal/Glass Metal/Cristal Metallo/Vetro

Brushed iron Hierro mateado Ferro spazzolato



**incl. 3×2,8 W**

3×170 lm, 2.700 K

∠ 100°

230/12 V, incl. 12 VA

EAN 4000870 935729

**935.72**

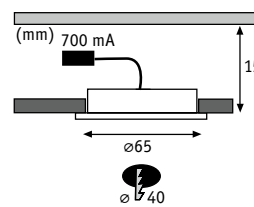

**Furniture Whirl Mini LED** Acrylic Acrílico Acrilico

Satin Satinado Satinato



**incl. 3×2,4 W**

3×115 lm, 2.700 K

∠ 100°

230 V, incl. 7 VA

EAN 4000870 998656

**998.65**



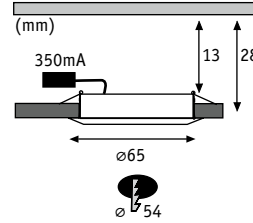

**Mirror Cabinet downlight**    Aluminium/Plastic    Aluminio/Plástico    Alluminio/Plastica

- ▶ Conversion set for mirror bathroom cabinets
- ▶ Set de conversión para armarios con espejo
- ▶ Kit di conversione per armadi a specchio

☞ Matt white    Blanco mate  
Bianco opaco



**incl. 2x2,5 W**  
2x225 lm, 3.000 K  
✗ 85°  
230/12 V, incl. ⚡ 7 VA  
EAN 4000870 999219  
**999.21**

☞ Chrome    Cromo    Cromo



**incl. 2x2,5 W**  
2x225 lm, 3.000 K  
✗ 85°  
230/12 V, incl. ⚡ 7 VA  
EAN 4000870 999202  
**999.20**

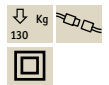
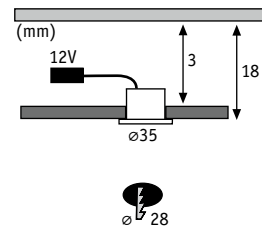

**Furniture Mini LED**    Metal    Metal    Metallo

☞ Brushed iron    Hierro mateado    Ferro spazzolato



**incl. 5x0,4 W**  
5x20 lm, 2.700 K  
✗ 90°  
230/12 V, incl. ⚡ 3,6 VA  
EAN 4000870 935866  
**935.86**

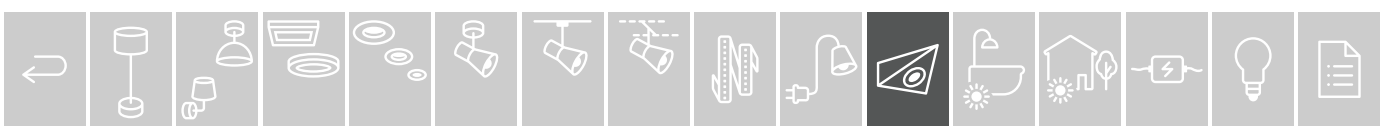



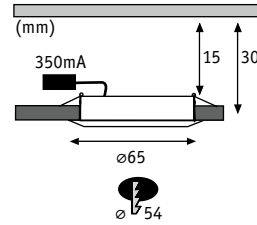

## Furniture LED

Metal Metal Metallo

White Blanco Bianco

**incl. 3×4,5 W**

3×305 lm, 2.700 K  
 ✕ 180°  
 230 V, incl. 12 VA  
 EAN 4000870 935545  
**935.54**

**incl. 1×4,5 W**

305 lm, 2.700 K  
 ✕ 180°  
 230 V, incl. 6 VA  
 EAN 4000870 935552  
**935.55**

Chrome Cromo Cromo

**incl. 3×4,5 W**

3×305 lm, 2.700 K  
 ✕ 180°  
 230 V, incl. 12 VA  
 EAN 4000870 935521  
**935.52**

Brushed iron Hierro mateado  
Ferro spazzolato**incl. 3×4,5 W**

3×305 lm, 2.700 K  
 ✕ 180°  
 230 V, incl. 12 VA  
 EAN 4000870 935538  
**935.53**





Perfect match

□ = 397

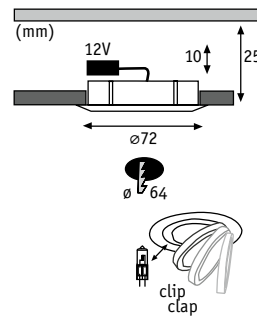

**Furniture Klipp Klapp**

☒ Metal/Glass Metal/Cristal Metallo/Vetro



☞ White Blanco Bianco

**max. 20 W**

12 V  
EAN 4000870 984666  
**984.66** ☒



☞ Chrome Cromo Cromo

**max. 20 W**

12 V  
EAN 4000870 984024  
**984.02** ☒



☞ Brushed iron Hierro mateado Ferro spazzolato

**max. 20 W**

12 V  
EAN 4000870 984079  
**984.07** ☒

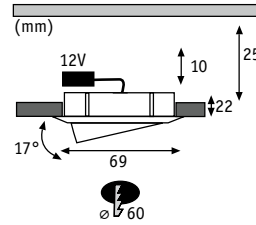

**Micro Line Swivel**

☒ Metal/Glass Metal/Cristal Metallo/Vetro



☞ Brushed iron Hierro mateado Ferro spazzolato

**max. 20 W**

12 V

EAN 4000870 984741

**984.74** 📄

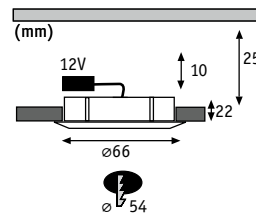
**Micro Line Structure**

☒ Metal/Glass Metal/Cristal Metallo/Vetro



☞ White Blanco Bianco

**max. 20 W**

12 V

EAN 4000870 984321

**984.32** 📄



☞ Brushed iron Hierro mateado Ferro spazzolato

**max. 20 W**

12 V

EAN 4000870 984499

**984.49** 📄



☞ Chrome Cromo Cromo

**max. 20 W**

12 V

EAN 4000870 984628

**984.62** 📄

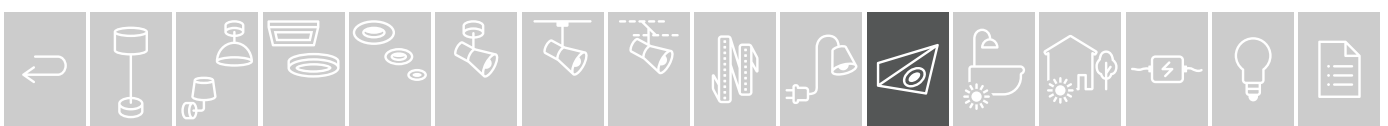



**Ace Basic**

☒ Metal/Plastic Metal/Plástico Metallo/Plastica



🔗 White/Satin Blanco/Satinado Bianco/Satinato

**incl. 1×7,5 W**  
 580 lm, 2.700 K  
 230/24 V, incl. ⚡ 24 VA  
 EAN 4000870 707760  
**707.76** 📦



🔗 White/Satin Blanco/Satinado Bianco/Satinato

**incl. 1×7,5 W**  
 580 lm, 2.700 K  
 DC 24 V  
 EAN 4000870 707777  
**707.77** 📦



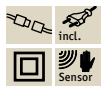

**TriX** Aluminium/Plastic Aluminio/Plástico Alluminio/Plastica

- ▶ LED cabinet lamp
- ▶ Clear cover with prism effect
- ▶ Super flat, high-quality aluminium profile
- ▶ Incl. touch switch
- ▶ Easily fixed in place with mounting clips
- ▶ Incl. power supply
- ▶ Luminarias de armario de LED
- ▶ Cubierta transparente con efecto prismático
- ▶ Perfil de aluminio extraplano de gran calidad
- ▶ Incl. interruptor táctil
- ▶ Fácil fijación mediante presillas de montaje
- ▶ Incl. fuente de alimentación
- ▶ Illuminazione LED
- ▶ Copertura chiara con effetto prisma
- ▶ Profilo in alluminio di qualità, ultrapiatto
- ▶ Interruttore touch incluso
- ▶ Facile da fissare grazie alle clip di montaggio
- ▶ Alimentazione inclusa

Matt aluminium/Black Aluminio mate/Negro Alluminio opaco/Nero



**incl. 1x4,2 W**

340 lm, 3.000 K

∠ 120°

230/12 V, incl. 7 VA

EAN 4000870 703984

**703.98**



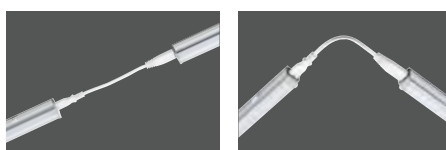

**Bond**

Aluminium/Plastic Aluminio/Plástico Alluminio/Plastica

- ▶ Linkable LED light bar with transparent end caps for a visually uninterrupted strip light. The lights can be joined in series using an integrated connector. Each light can be controlled individually. Easy installation with mounting clips.
- ▶ Incl. power cable with standardised European plug
- ▶ Incl. connector for curves or transition areas
- ▶ Minimum dimensions
- ▶ Barras de luces LED concatenables con tapas en los extremos para crear una cinta de luz continua y sin interrupciones visibles. Las lámparas pueden acoplarse una detrás de otra mediante un conector integrado. Cada lámpara puede encenderse por separado. Sencilla instalación con clips de montaje.
- ▶ Incl. cable de alimentación con euroconector
- ▶ Incl. piezas de conexión para curvas o transiciones
- ▶ Dimensiones mínimas
- ▶ Listello LED concatenabile con cappucci terminali trasparenti per una striscia luminosa senza soluzione di continuità. Le luci possono essere combinate una dopo l'altra grazie a un connettore integrato. Ogni luce è comandabile singolarmente. Semplice installazione grazie alle clip di montaggio.
- ▶ Cavo di alimentazione incluso con spina europea
- ▶ Con cavo di collegamento per curve o punti di transizione
- ▶ Dimensioni minime

Satin Satinado Satinato



**incl. 1x5 W**

370 lm, 4.000 K  
230 V  
EAN 4000870 706060  
**706.06**

**incl. 1x8 W**

720 lm, 4.000 K  
230 V  
EAN 4000870 706121  
**706.12**

**incl. 1x12 W**

950 lm, 4.000 K  
230 V  
EAN 4000870 706138  
**706.13**

**incl. 1x15 W**

1,200 lm, 4.000 K  
230 V  
EAN 4000870 706145  
**706.14**

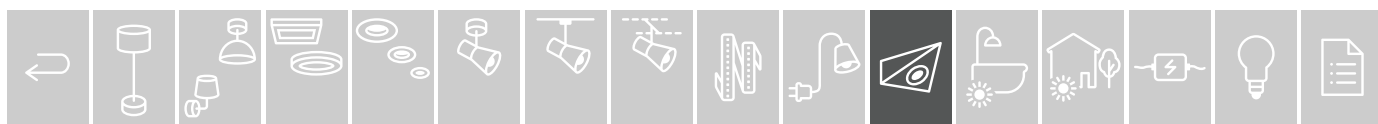

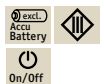

## SnapLED

Plastic Plástico Plastica

- ▶ Optimal for sliding doors: Miniature LED light with roller for battery operation. When a cabinet door is opened, the roller automatically switches the light on and off again. Light that is simply there when you need it.
- ▶ Easy installation; simply fasten removable mounting base with adhesive pads or screws
- ▶ Easily accessible battery compartment
- ▶ Operated with 4x1.5V AAA (excl.)
- ▶ Clear cover and reflector for optimised light yield
- ▶ Ideal para puertas corredizas: miniluminarias de LEDs con rueda corredera para usar a pilas. La rueda enciende y apaga automáticamente la luz al abrirse o cerrarse una puerta del ropero. Sencillamente: luz cuando y donde se necesita.
- ▶ Fácil de fijar: base separable que puede fijarse con tornillos o almohadillas adhesivas
- ▶ Compartimento de pilas fácilmente accesible
- ▶ Funciona con 4 pilas AAA de 1,5V (no incl.)
- ▶ Cubierta transparente y reflector para un óptimo rendimiento lumínico
- ▶ Ottima per le porte scorrevoli: miniluce a LED con rullino di scorrimento funzionante a batteria. Il rullino di scorrimento accende automaticamente la luce quando una porta dell'armadio viene aperta, e successivamente torna a spegnerla. Per avere la luce giusta al momento giusto - né più, né meno.
- ▶ Montaggio semplice con base separabile per fissaggio con cuscinetti adesivi o viti
- ▶ Vano batterie facilmente accessibile
- ▶ Funzionamento con 4 batterie AAA da 1,5 V (non incluse)
- ▶ Copertura trasparente e riflettore per una propagazione ottimale della luce

☞ Silver Plateado Argento



**incl. 1x0,33 W**

30 lm, 2.700 K

✕ 120°

4xAAA/1,5V (Micro)

EAN 4000870 704981

**704.98** €





- ▶ Multifunctional battery lights with a range of uses in furniture or beneath hanging cupboards for even working light, directional spot lighting or as a helpful orientation light. Some models can be dimmed, fitted with swivelling spot heads or motion detectors.
- ▶ Incl. assembly plate for easy battery replacement
- ▶ Easy to attach using adhesive or velcro pads
- ▶ Lámparas multifuncionales de pilas con multitud de posibilidades de aplicación en muebles o armarios instalados en pared, para una luz de trabajo uniforme, una iluminación directa con focos o como una práctica luz de orientación. Dependiendo del modelo: regulables, con cabezales de foco orientables o con sensores de movimiento.
- ▶ Incl. placa de montaje para un sencillo cambio de las pilas
- ▶ Fácil fijación con tiras adhesivas o velcro
- ▶ Luci multifunzione a batteria con diverse possibilità di impiego in mobili o sotto ai pensili per una luce di lavoro omogenea, per un'illuminazione mirata con spot o per l'utile luce di orientamento. A seconda del modello: dimmerabili, equipaggiabili con spot orientabili o sensori di movimento.
- ▶ Con piastra di montaggio compresa per una semplice sostituzione della batteria
- ▶ Semplice fissaggio con adesivi o velcro

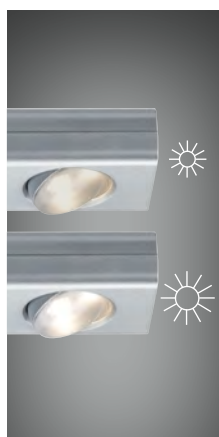

### Jiggle

incl. 3x0,18 W  
3x22 lm, 3.000 K  
∠ 105°  
6xAAA/1,5V (Micro)  
∅35 ⇄300 ↗60 mm  
EAN 4000870 706350

706.35

☞ Chrome matt ☞ Plastic  
☞ Cromo mate ☞ Plástico  
☞ Cromo opaco ☞ Plastica



### Rotate

incl. 3x0,2 W  
3x18 lm, 3.000 K  
∠ 105°  
6xAAA/1,5V (Micro)  
∅50 ⇄310 ↗60 mm  
EAN 4000870 706367

706.36

☞ Anthracite/Chrome matt ☞ Plastic  
☞ Antracita/Cromo mate ☞ Plástico  
☞ Antracite/Cromo opaco ☞ Plastica







### SmartLight

incl. 1x1,6 W  
 140 lm, 3.000 K  
 <math>\sphericalangle</math> 100°  
 3xAA/1,5 V (Mignon)  
 <math>\updownarrow</math>27 <math>\leftrightarrow</math>250 <math>\curvearrowright</math>55 mm  
 EAN 4000870 706381  
**706.38**

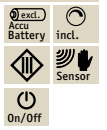

☞ Chrome matt 

--	--	--	--

 Plastic  
 ☞ Cromo mate 

--	--	--	--

 Plástico  
 ☞ Cromo opaco 

--	--	--	--

 Plastica



### Rotate

incl. 1x1 W  
 66 lm, 3.000 K  
 <math>\sphericalangle</math> 20°  
 3xAA/1,5 V (Mignon)  
 <math>\varnothing</math>92 <math>\curvearrowright</math>72 mm  
 EAN 4000870 706374  
**706.37**



☞ Chrome matt 

--	--	--	--

 Plastic  
 ☞ Cromo mate 

--	--	--	--

 Plástico  
 ☞ Cromo opaco 

--	--	--	--

 Plastica



### ButtonLED

incl. 1x0,6 W  
 70 lm, 3.000 K  
 <math>\sphericalangle</math> 105°  
 3xAAA/1,5V (Micro)  
 <math>\updownarrow</math>41 <math>\varnothing</math>88 mm  
 EAN 4000870 706398  
**706.39**



☞ Anthracite 

--	--	--	--

 Plastic  
 ☞ Antracita 

--	--	--	--

 Plástico  
 ☞ Antracite 

--	--	--	--

 Plastica



# Bathroom



☒ = 444



☒ = 317



☒ = 305

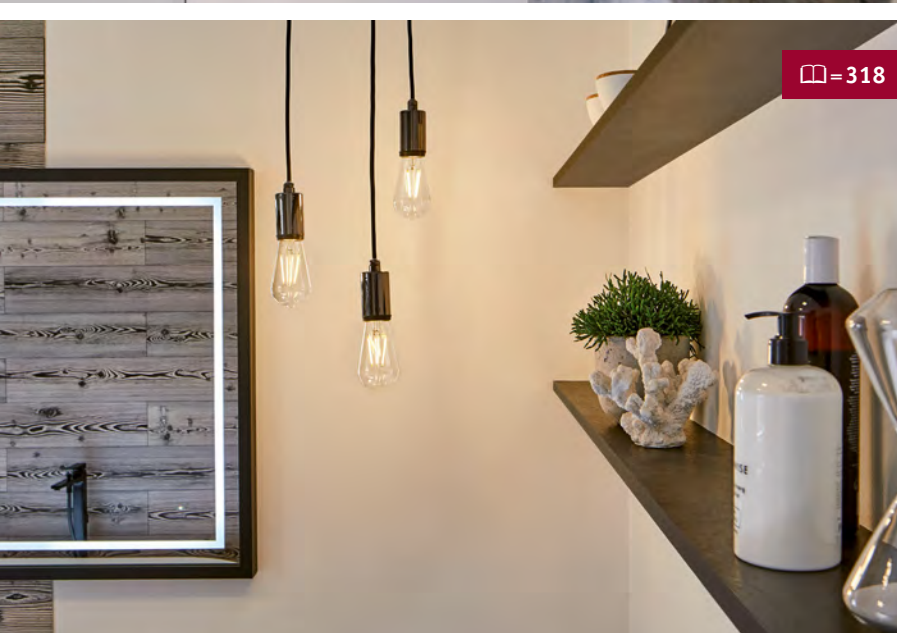

☒ = 318





**Aviar**

incl. 1x22,5 W  
 2.400 lm, 2.700 K  
 230 V  
 ⚡62 ø300 mm  
 EAN 4000870 708828  
**708.82**



- 🔩 Chrome 🏠 Plastic
- 🔩 Cromo 🏠 Plástico
- 🔩 Cromo 🏠 Plastica





- 🌀 Matt white 🏠 Plastic
- 🌀 Blanco mate 🏠 Plástico
- 🌀 Bianco opaco 🏠 Plastica



**Cela**

incl. 1×15,5 W  
 2.200 lm, 3.000 - 6.500 K  
 230 V  
 ⚡50 ⇄280 ⚡280 mm  
 EAN 4000870 798393  
**798.39**



- 🌀 White 🏠 Plastic
- 🌀 Blanco 🏠 Plástico
- 🌀 Bianco 🏠 Plastica



**Leonis**

incl. 1×10,4 W  
 1.200 lm, 2.700 K  
 230 V, incl. ⚡14,5 VA  
 ⚡95 ⌀280 mm  
 EAN 4000870 707227  
**707.22**

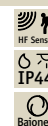

**Leonis**

incl. 1×10 W  
 1.280 lm, 3.000 K  
 230 V  
 ⚡95 ⌀280 mm  
 EAN 4000870 709818  
**709.81**



- 🌀 White 🏠 Plastic
- 🌀 Blanco 🏠 Plástico
- 🌀 Bianco 🏠 Plastica



**Leonis**

incl. 1×9,5 W  
 1.200 lm, 4.000 K  
 230 V, incl. ⚡14,5 VA  
 ⚡95 ⌀280 mm  
 EAN 4000870 707241  
**707.24**



**Leonis**

incl. 1×10 W  
 1.310 lm, 4.000 K  
 230 V  
 ⚡95 ⌀280 mm  
 EAN 4000870 709801  
**709.80**

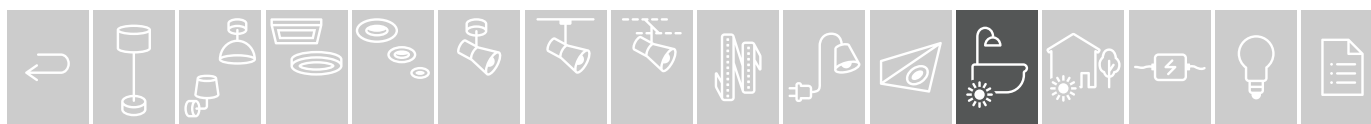



**Doradus**

incl. 2×4,7 W  
2×420 lm, 3.000 K  
230 V  
∅95 ⇔230 ∅42 mm  
EAN 4000870 708835  
**708.83**



**Doradus**

incl. 3×4,7 W  
3×420 lm, 3.000 K  
230 V  
∅95 ⇔350 ∅42 mm  
EAN 4000870 708767  
**708.76**



**Doradus**

incl. 3×4,7 W  
3×420 lm, 3.000 K  
230 V  
∅42 ∅250 mm  
EAN 4000870 708743  
**708.74**



☞ Chrome ☒ Metal/Plastic  
☞ Cromo ☒ Metal/Plástico  
☞ Cromo ☒ Metallo/Plastica

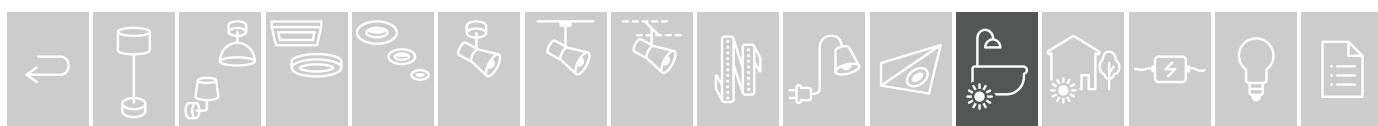



**Carina**

max. 28W, G9  
230V  
⌀157 ⌀105 ⇄105 ↗115 mm  
EAN 4000870 708385  
**708.38**



- ☞ Chrome matt/Satin ☒ Metal/Glass
- ☞ Cromo mate/Satinado ☒ Metal/Cristal
- ☞ Cromo opaco/Satinato ☒ Metallo/Vetro



**Eleon**

max. 33W, G9  
230V  
⌀203 ⌀105 ⇄105 ↗135 mm  
EAN 4000870 708392  
**708.39**



- ☞ Chrome/Satin ☒ Metal/Glass
- ☞ Cromo/Satinado ☒ Metal/Cristal
- ☞ Cromo/Satinato ☒ Metallo/Vetro



**Gemini Set**

max. 2x20W, E14  
230V  
⌀195 ⇄85 ↗105 mm  
EAN 4000870 703540  
**703.54**



- ☞ Chrome/Satin ☒ Metal/Glass
- ☞ Cromo/Satinado ☒ Metal/Cristal
- ☞ Cromo/Satinato ☒ Metallo/Vetro

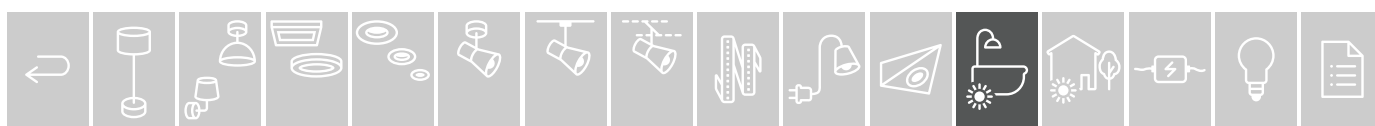



**Lenia**

max. 2x20 W, E14  
230 V  
⌀80 ⇄330 ↗105 mm  
EAN 4000870 703502  
**703.50**



🌀 Chrome/Opaque 🗪 Metal/Glass  
🌀 Cromo/Opaco 🗪 Metal/Cristal  
🌀 Cromo/Opaco 🗪 Metallo/Vetro



**Lukida**

incl. 1x9 W  
650 lm, 3.000 K  
230 V, incl. ⚡10 VA  
⌀100 ⇄600 ↗42 mm  
EAN 4000870 704639  
**704.63**



🌀 Chrome/White 🗪 Aluminium/Acrylic  
🌀 Cromo/Blanco 🗪 Aluminio/Acrílico  
🌀 Cromo/Bianco 🗪 Alluminio/Acrilico



**Nembus**

incl. 1x9 W  
600 lm, 3.000 K  
230 V, incl. ⚡10 VA  
⌀68 ⇄600 ↗63 mm  
EAN 4000870 704646  
**704.64**



🌀 Chrome/White 🗪 Metal/Acrylic  
🌀 Cromo/Blanco 🗪 Metal/Acrílico  
🌀 Cromo/Bianco 🗪 Metallo/Acrilico

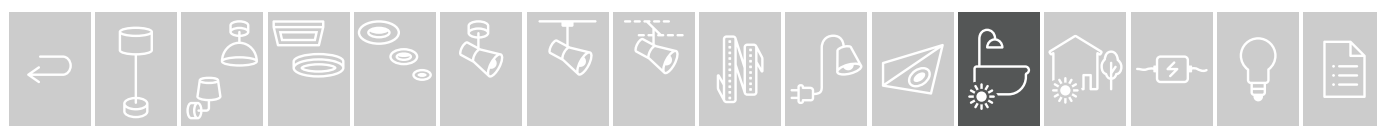

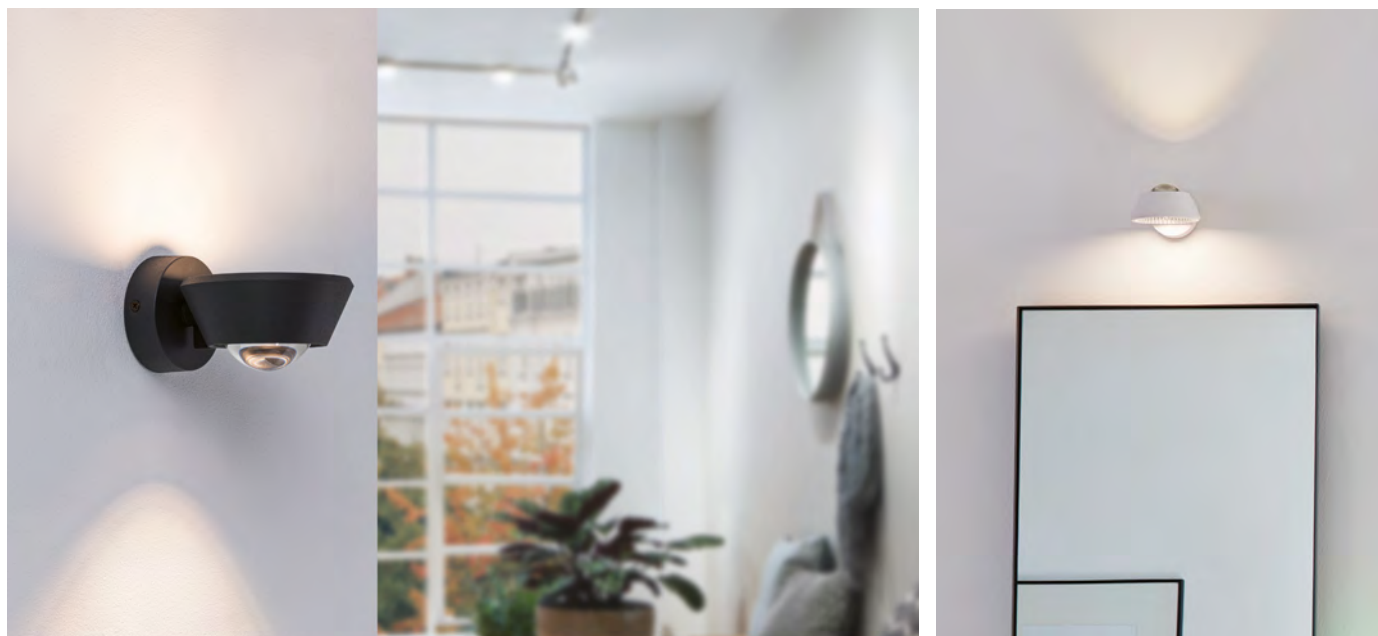

↳ Matt white Plastic  
↳ Blanco mate Plástico  
↳ Bianco opaco Plastica

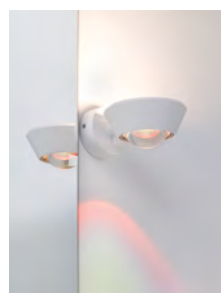

incl. dichroic foil

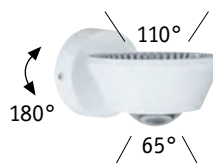

**Sabik**

incl. 1x9 / 1x4 W  
840 + 320 lm, 2.700 K  
230 V  
⌀80 ⇄117 ⚓152 mm  
EAN 4000870 709467  
**709.46**



↳ Chrome Plastic  
↳ Cromo Plástico  
↳ Cromo Plastica

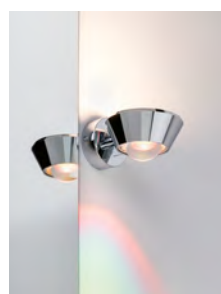

incl. dichroic foil

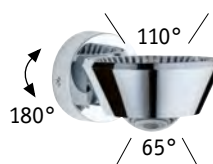

**Sabik**

incl. 1x9 / 1x4 W  
840 + 320 lm, 2.700 K  
230 V  
⌀80 ⇄117 ⚓152 mm  
EAN 4000870 709474  
**709.47**



↳ Black Plastic  
↳ Negro Plástico  
↳ Nero Plastica

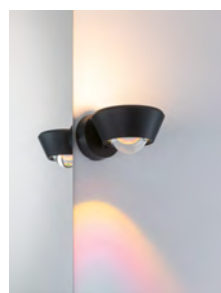

incl. dichroic foil

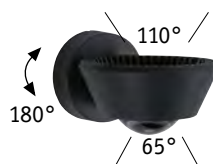

**Sabik**

incl. 1x9 / 1x4 W  
840 + 320 lm, 2.700 K  
230 V  
⌀80 ⇄117 ⚓152 mm  
EAN 4000870 797693  
**797.69 new**

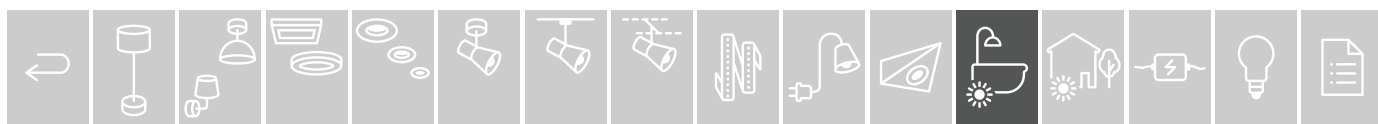





**Agena**

incl. 1x20 W  
 1.800 lm, 2.700 K  
 230 V  
 ⌀50 ⇄310 ⚙125 mm  
 EAN 4000870 709481  
**709.48**

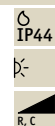

🔗 Chrome/Matt white 📦 Aluminium/  
 Stainless steel  
 🔗 Cromo/Blanco mate 📦 Aluminio/  
 Acero inoxidable  
 🔗 Cromo/Bianco opaco 📦 Alluminio/  
 Acciaio legato



**Arneb**

incl. 1x9 W  
 700 lm, 3.000 K  
 230 V  
 ⌀40 ⇄326 ⚙78 mm  
 EAN 4000870 708781  
**708.78**



🔗 White 📦 Aluminium/Acrylic  
 🔗 Blanco 📦 Aluminio/Acrílico  
 🔗 Bianco 📦 Alluminio/Acrílico



**Arneb**

incl. 1x9 W  
 700 lm, 3.000 K  
 230 V  
 ⌀40 ⇄326 ⚙78 mm  
 EAN 4000870 708798  
**708.79**



🔗 Chrome 📦 Aluminium/Acrylic  
 🔗 Cromo 📦 Aluminio/Acrílico  
 🔗 Cromo 📦 Alluminio/Acrílico



**Kuma**

incl. 1x9 W  
 660 lm, 3.000 K  
 230 V, incl. ⚡10 VA  
 ⌀45 ⇄500 ⚙84 mm  
 EAN 4000870 704707  
**704.70**



🔗 Chrome/White 📦 Metal/Acrylic  
 🔗 Cromo/Blanco 📦 Metal/Acrílico  
 🔗 Cromo/Bianco 📦 Metallo/Acrílico

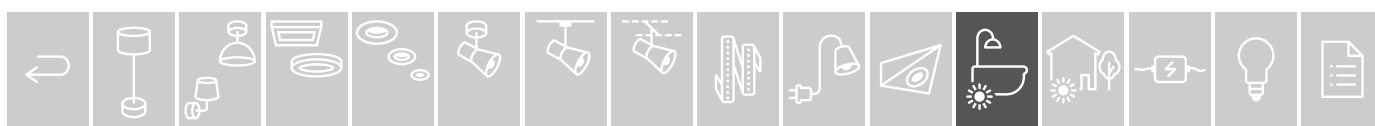



Chrome/White Metal/Acrylic  
 Cromo/Blanco Metal/Acrílico  
 Cromo/Bianco Metallo/Acricico

**Mizar**

incl. 1x10,5 W  
 1.400 lm, 3.000 K  
 230 V  
 45 ⇄ 630 82 mm  
 EAN 4000870 797167  
**797.16**



Chrome/White Metal/Acrylic  
 Cromo/Blanco Metal/Acrílico  
 Cromo/Bianco Metallo/Acricico

**Orgon**

incl. 1x7,5 W  
 980 lm, 3.000 K  
 230 V  
 60 ⇄ 440 82 mm  
 EAN 4000870 797129  
**797.12**

**Orgon**

incl. 1x10,5 W  
 1.400 lm, 3.000 K  
 230 V  
 60 ⇄ 700 82 mm  
 EAN 4000870 797136  
**797.13**



Chrome/White Metal/Acrylic  
 Cromo/Blanco Metal/Acrílico  
 Cromo/Bianco Metallo/Acricico

**Quasar**

incl. 1x7,5 W  
 980 lm, 3.000 K  
 230 V  
 45 ⇄ 440 60 mm  
 EAN 4000870 797143  
**797.14**

**Quasar**

incl. 1x10,5 W  
 1.400 lm, 3.000 K  
 230 V  
 45 ⇄ 700 60 mm  
 EAN 4000870 797150  
**797.15**





**Bela**

incl. 1x5,7 W  
 260 lm, 3.000 K  
 230 V, incl.  $\pm$ 8,4 VA  
 $\varnothing$ 230  $\leftrightarrow$ 230  $\nabla$ 295 mm  
 EAN 4000870 704684  
**704.68**



- 🔗 Chrome/Mirror  $\boxtimes$  Metal/Acrylic
- 🔗 Cromo/Blanco/Espejo  $\boxtimes$  Metal/Acrílico
- 🔗 Cromo/Bianco/Specchio  $\boxtimes$  Metallo/Acricico



**Mirror Zylindro**

incl. 1x3 W  
 120 lm, 2.700 K  
 $\sphericalangle$  60°  
 230 V, incl.  $\pm$ 3 VA  
 $\varnothing$ 260  $\leftrightarrow$ 80  $\nabla$ 235 mm  
 EAN 4000870 990681  
**990.68**



- 🔗 Chrome  $\boxtimes$  Metal
- 🔗 Cromo  $\boxtimes$  Metal
- 🔗 Cromo  $\boxtimes$  Metallo



**Galeria Double Hook**

incl. 2x3,2 W  
 2x378 lm, 2.700 K  
 $\sphericalangle$  100°  
 230 V  
 $\varnothing$ 80  $\leftrightarrow$ 300  $\nabla$ 110 mm  
 EAN 4000870 993859  
**993.85**

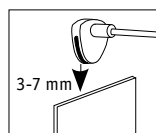

- 🔗 Chrome  $\boxtimes$  Metal
- 🔗 Cromo  $\boxtimes$  Metal
- 🔗 Cromo  $\boxtimes$  Metallo

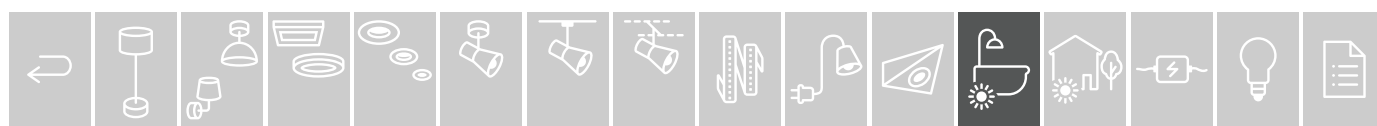



**Mintaka**

max. 20 W, GU10  
230 V  
∅38 ↔56 ∅120 mm  
EAN 4000870 708804  
**708.80**



- ☞ Chrome ☐ Metal
- ☞ Cromo ☐ Metal
- ☞ Cromo ☐ Metallo

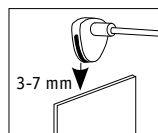

**Mirror Simple**

incl. 1×5,3 W, GU10  
345 lm, 2.700 K  
230 V  
∅60 ∅51 ↔30 ∅100 mm  
EAN 4000870 999059  
**999.05**



- ☞ Brushed iron ☐ Metal
- ☞ Hierro mateado ☐ Metal
- ☞ Ferro spazzolato ☐ Metallo

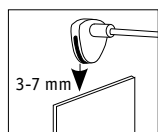

**Becrux**

incl. 1×4 W  
460 lm, 3.000 K  
230 V  
∅93 ↔93 ∅140 mm  
EAN 4000870 708811  
**708.81**





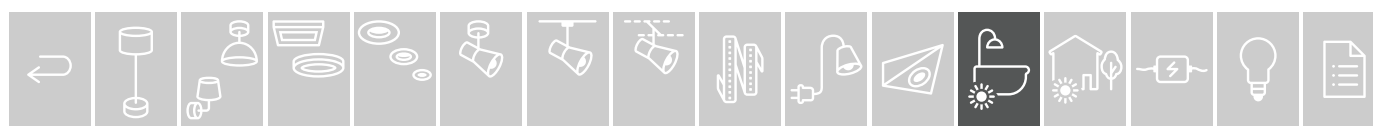
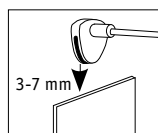

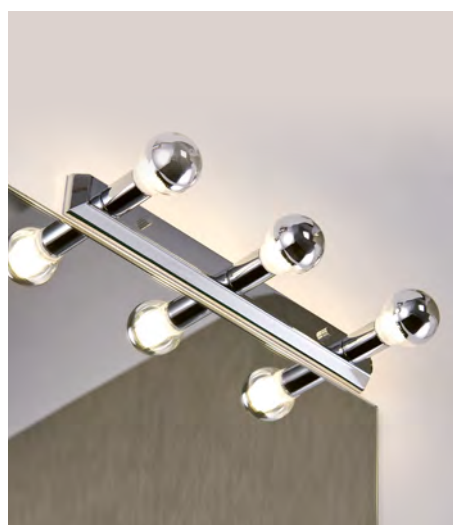

- ☞ Chrome ☐ Metal/Plastic
- ☞ Cromo ☐ Metal/Plástico
- ☞ Cromo ☐ Metallo/Plastica





Perfect match  
 = 416

-  Chrome  Metal
-  Cromo  Metal
-  Cromo  Metallo



**Mirror Regula**

max. 3x40 W, E14  
 230 V  
 ⌀75 ⇄420 ⌀50 mm  
 EAN 4000870 996799  
**996.79**



**Mirror Regula**

max. 5x40 W, E14  
 230 V  
 ⌀75 ⇄650 ⌀50 mm  
 EAN 4000870 996805  
**996.80**

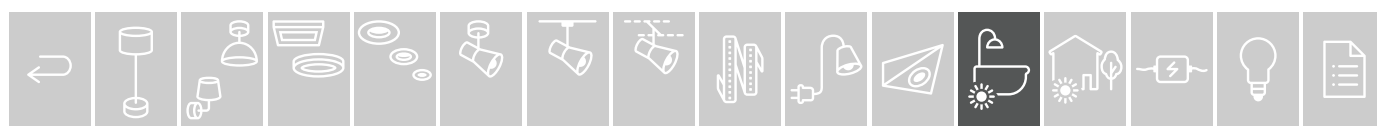



- 🔗 White/Chrome 📏 Metal
- 🔗 Blanco/Cromo 📏 Metal
- 🔗 Bianco/Cromo 📏 Metallo



**Zyli**  
 max. 10W, GU10  
 230V  
 ⚙️ 110 ⌀100 mm  
 EAN 4000870 667101  
**667.10**



**Zyli**  
 max. 2x10W, GU10  
 230V  
 ⚙️ 110 ⇄400 ↗70 mm  
 EAN 4000870 667118  
**667.11**



**Zyli**  
 max. 3x10W, GU10  
 230V  
 ⚙️ 110 ⇄600 ↗70 mm  
 EAN 4000870 667132  
**667.13**



**Zyli**  
 max. 3x10W, GU10  
 230V  
 ⚙️ 110 ⌀250 mm  
 EAN 4000870 667125  
**667.12**

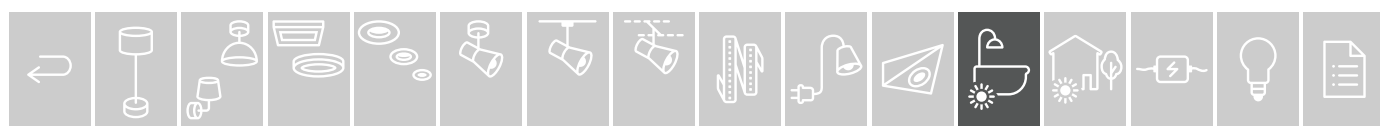



⌘ White/Chrome Metal  
 ⌘ Blanco/Cromo Metal  
 ⌘ Bianco/Cromo Metallo



**Tube**

max. 10 W, GU10  
 230 V  
 ⚡ 138 ⌀100 ↗94 mm  
 EAN 4000870 667170  
**667.17**



**Tube**

max. 2×10 W, GU10  
 230 V  
 ⚡ 94 ↔350 ↗65 mm  
 EAN 4000870 667187  
**667.18**



**Tube**

max. 3×10 W, GU10  
 230 V  
 ⚡ 94 ⌀250 mm  
 EAN 4000870 667194  
**667.19**



⌘ Anthracite/Chrome Metal  
 ⌘ Antracita/Cromo Metal  
 ⌘ Antracite/Cromo Metallo



Perfect match

= 424, 401



**Carolina**

max. 10 W, GU10  
 230 V  
 ⚡ 110 ⌀80 mm  
 EAN 4000870 667507  
**667.50**



**Carolina**

max. 2×10 W, GU10  
 230 V  
 ⚡ 128 ↔264 ↗80 mm  
 EAN 4000870 667514  
**667.51**



**Carolina**

max. 3×10 W, GU10  
 230 V  
 ⚡ 110 ⌀200 mm  
 EAN 4000870 667521  
**667.52**

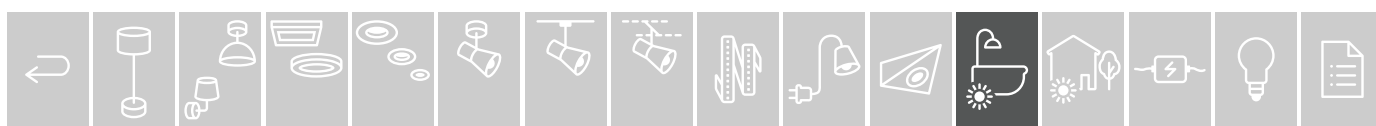

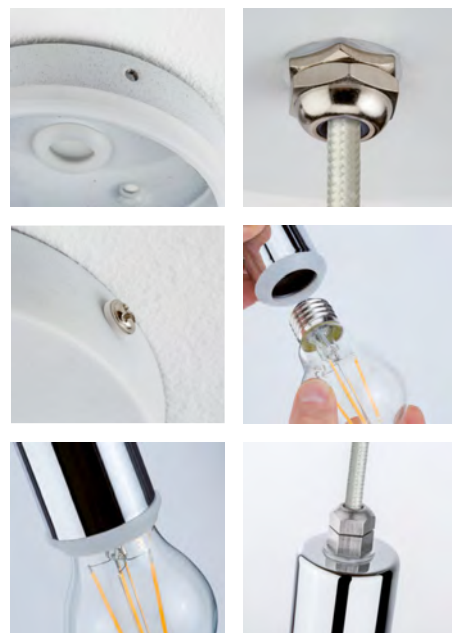

Perfect match

☑ = 412-419



**Larus**

max. 20W, E27  
230V  
159 cm ø110 mm  
EAN 4000870 797532  
**797.53**

- Chrome Metal
- Cromo Metal
- Cromo Metallo



**Larus**

max. 20W, E27  
230V  
159 cm ø110 mm  
EAN 4000870 797549  
**797.54**

- Black chrome Metal
- Negro cromo Metal
- Cromo Nero Metallo



**Ketil**

max. 20W, E27  
230V  
200 cm ø92 mm  
EAN 4000870 503461  
**503.46**

- Black Silicone/Plastic
- Negro Silicona/Plástico
- Nero Silicone/Plastica

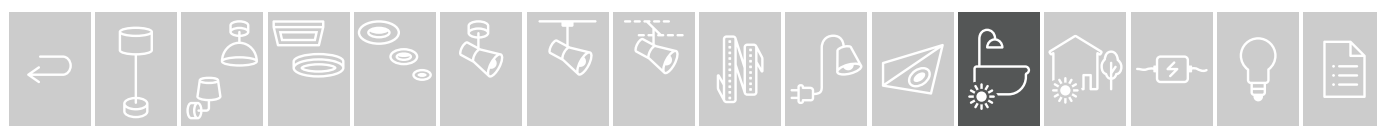





 Fabric cable  
Cable textil  
Cavo tessile

 Perfect match  
☑ = 409-412

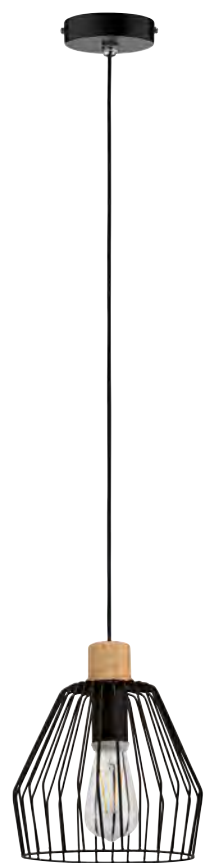

**Globe**  
max. 20W, E27  
230V  
110 cm ø200 mm  
EAN 4000870 708958  
**708.95**





-  Satin/Chrome  Glass/Metal
-  Satinado/Cromo  Cristal/Metal
-  Satinato/Cromo  Vetro/Metallo







**Verve**  
max. 20W, E27  
230V  
110 cm ø200 mm  
EAN 4000870 708903  
**708.90**

  
  
  

-  Grey/Chrome  Concrete/Metal
-  Gris/Cromo  Hormigón/Metal
-  Grigio/Cromo  Cemento/Metallo

**Cameo**  
max. 20W, E27  
230V  
110 cm ø220 mm  
EAN 4000870 708910  
**708.91**

-  Black/Wood  Metal/Wood
-  Negro/Madera  Metal/Madera
-  Nero/Legno  Metallo/Legno

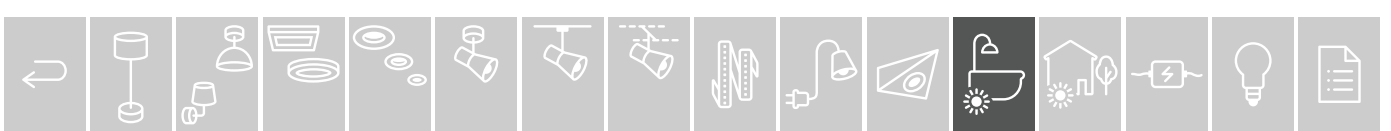

# Outdoor

322 Plug & Shine

346 Park + Light

350 House

365 Solar

383 Mobile



## Park + Light

EN The innovative 12V lighting system for carports

ES El innovador sistema de iluminación de 12 V para carports

IT L'innovativo sistema di illuminazione da 12V per carport



## Solar

EN Solar-powered luminaires for outdoor use, no power connection required

ES Luminarias solares para el exterior, independientes de las tomas de corriente

IT Apparecchi a energia solare per esterno, indipendenti dall'allacciamento alla corrente

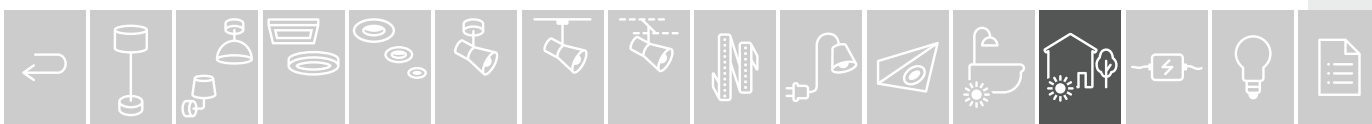

# Plug & Shine



EN 24 V LED lighting system for fascinating lighting in the garden and on the patio

ES Sistema de luz LED de 24 V para una fascinante iluminación del jardín y la terraza

IT Sistema di illuminazione a LED da 24V per una luce accattivante in giardino e in terrazza

📖 = 322

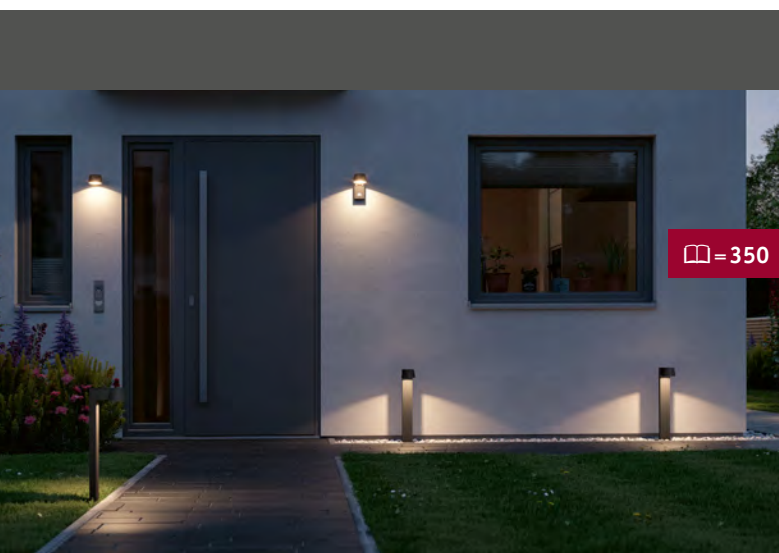

📖 = 350

# House

EN Reliable 230 V luminaires for lighting around the house

ES Las eficaces luminarias de 230 V para iluminar el entorno de la casa

IT Le affidabili lampade da 230 V per ottenere luce intorno alla casa



# Mobile

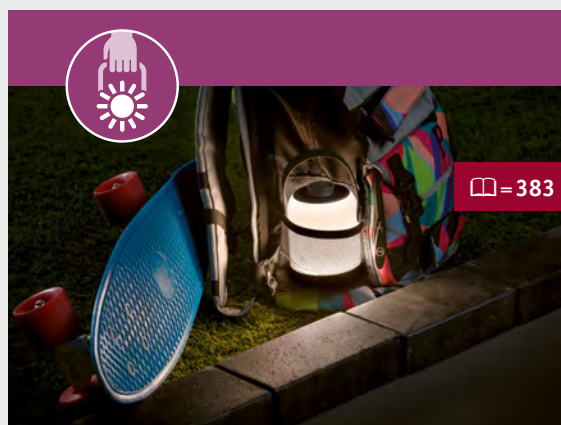

📖 = 383

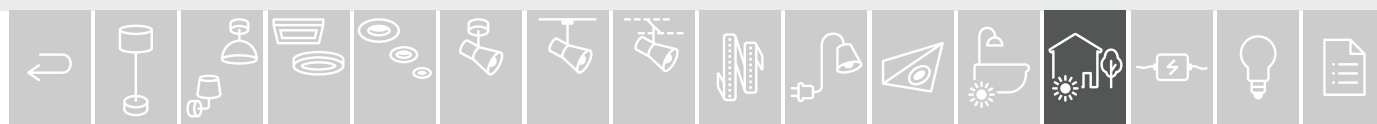



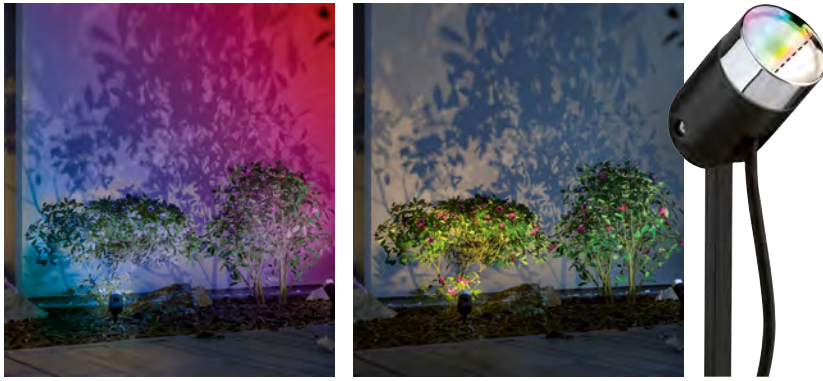

- ▶ Starter sets for the system include three luminaires, five metres of cable with four outputs and one transformer
- ▶ Extendable
- ▶ Stepless light colour control via ZigBee remote control, app or voice control
- ▶ Perfect for atmospheric spotlighting of plants or objects
- ▶ Juegos de iniciación para iniciarse en el sistema, con 3 luminarias, 5 metros de cable con 4 salidas y un transformador
- ▶ Ampliable
- ▶ Control continuo de la tonalidad de la luz con mando a distancia ZigBee, aplicación o voz
- ▶ Ideal para la iluminación sugerente de plantas u objetos
- ▶ Starter set per familiarizzare con il sistema, comprendente 3 apparecchi di illuminazione, cavo da 5 m con 4 uscite e un trasformatore
- ▶ Ampliabili
- ▶ Comando dei colori a regolazione illimitata tramite telecomando Zigbee, app o sistema vocale
- ▶ Ideale per illuminare piante o oggetti



**Plug & Shine Spot Pike Starter-Set**

incl. 3x4,2W  
 3x330 lm, 3.000 - 6.500 K  
 24V, incl. ⚡ 21 VA  
 ⚙ 313 ⌀50 ⚙ 82 mm  
 EAN 4000870 942840  
**942.84**



🔗 Anthracite 🗪 Plastic  
 🔗 Antracita 🗪 Plástico  
 🔗 Antracite 🗪 Plastica

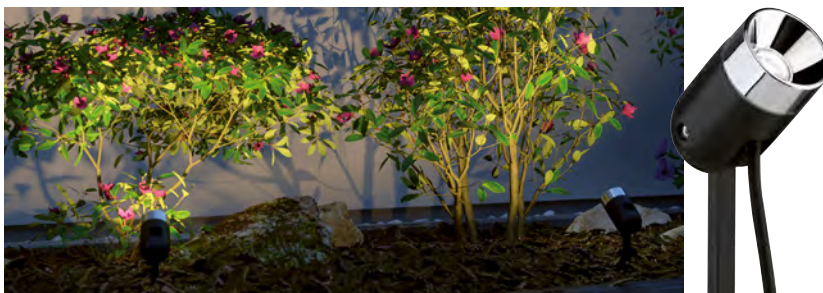

- ▶ With 45° beam angle ideal for spotlighting plants or objects
- ▶ Ground spike for easy installation in any garden
- ▶ Con un ángulo de irradiación de 45°, ideal para iluminar plantas u objetos
- ▶ Estaca para la instalación flexible en cualquier jardín
- ▶ Con angolo emissione a 45°, ideale per illuminare piante o oggetti
- ▶ Paletto per un'installazione flessibile in ogni giardino



**Plug & Shine Spot Pike Starter-Set**

incl. 3x3W  
 3x370 lm, 3.000 K  
 < 45°  
 230/24V, incl. ⚡ 21 VA  
 ⚙ 313 mm ⌀50 mm ⚙ 82 mm ↔ 5 m  
 EAN 4000870 942420  
**942.42** 📦



🔗 Anthracite 🗪 Plastic  
 🔗 Antracita 🗪 Plástico  
 🔗 Antracite 🗪 Plastica





- ▶ Starter sets for the system include 3 luminaires, 5 metres of cable with 4 outputs and one transformer for optional system expansion
- ▶ Extendable

- ▶ Juegos de iniciación para iniciarse en el sistema, con 3 luminarias, 5 metros de cable con 4 salidas y un transformador para la ampliación
- ▶ Ampliable

- ▶ Starter set per familiarizzare con il sistema, comprendente 3 apparecchi di illuminazione, cavo da 5 m con 4 uscite e un trasformatore per possibilità di ampliamento
- ▶ Ampliabili



#### Plug & Shine Spot Classic Starter-Set

incl. 3x5,1 W  
 3x310 lm, 3.000 K  
 <math>\sphericalangle</math> 32°  
 230/24 V, incl.  $\approx$  75 VA  
 $\updownarrow$  265 mm  $\varnothing$  88 mm  $\leftrightarrow$  5 m  
 EAN 4000870 942864  
**942.86**



Anthracite Metal  
 Antracita Metal  
 Antracite Metallo

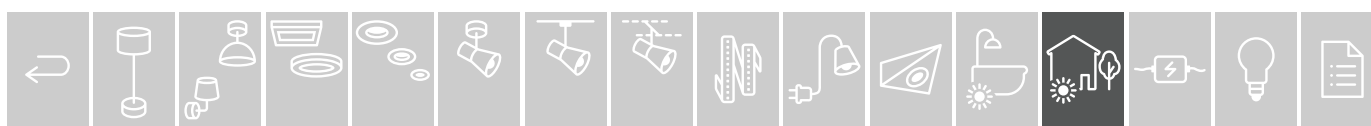

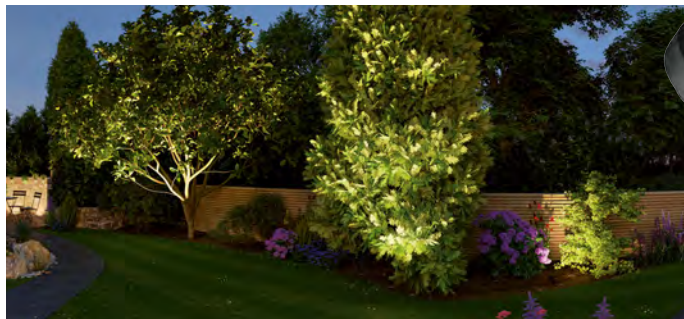

- ▶ Starter sets for the system include 3 luminaires, 5 metres of cable with 4 outputs and one transformer for optional system expansion
- ▶ Extendable

- ▶ Juegos de iniciación para iniciarse en el sistema, con 3 luminarias, 5 metros de cable con 4 salidas y un transformador para la ampliación
- ▶ Ampliable

- ▶ Starter set per familiarizzare con il sistema, comprendente 3 apparecchi di illuminazione, cavo da 5 m con 4 uscite e un trasformatore per possibilità di ampliamento
- ▶ Ampliabili



**Plug & Shine Spot Sting Starter-Set**

incl. 3x6,4 W  
 3x520 lm, 3.000 K  
 <math>\sphericalangle</math> 100°  
 230/24 V, incl.  $\pm$  75 VA  
 $\updownarrow$  290 mm  $\varnothing$  52 mm  $\leftrightarrow$  5 m  
 EAN 4000870 936962  
**936.96**



- ☞ Anthracite  $\boxtimes$  Aluminium
- ☞ Antracita  $\boxtimes$  Aluminio
- ☞ Antracite  $\boxtimes$  Alluminio

- ▶ Expansion sets for easy system expansion include 3 luminaires and 5 metres of cable with 4 outputs

- ▶ Juegos de ampliación para ampliar fácilmente el sistema, con 3 luminarias y 5 metros de cable con 4 salidas

- ▶ Set di ampliamento per estendere il sistema, comprendente 3 lampade e cavo da 5 m con 4 uscite



**Plug & Shine Spot Sting Extension-Set**

incl. 3x6,4 W  
 3x520 lm, 3.000 K  
 <math>\sphericalangle</math> 100°  
 24 V  
 EAN 4000870 936894  
**936.89**



- ☞ Anthracite  $\boxtimes$  Aluminium
- ☞ Antracita  $\boxtimes$  Aluminio
- ☞ Antracite  $\boxtimes$  Alluminio

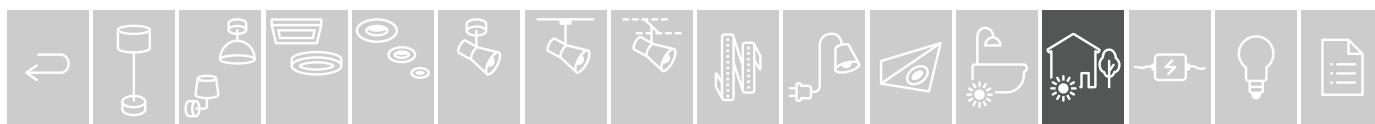



- ▶ Starter sets for the system include 3 luminaires, 5 metres of cable with 4 outputs and one transformer for optional system expansion
- ▶ Extendable

- ▶ Juegos de iniciación para iniciarse en el sistema, con 3 luminarias, 5 metros de cable con 4 salidas y un transformador para la ampliación
- ▶ Ampliable

- ▶ Starter set per familiarizzare con il sistema, comprendente 3 apparecchi di illuminazione, cavo da 5 m con 4 uscite e un trasformatore per possibilità di ampliamento
- ▶ Ampliabili



#### Plug & Shine Spot Plantini Starter-Set

incl. 3×2,5 W  
3×200 lm, 3.000 K  
◄ 45°  
230/24 V, incl. ◄ 21 VA  
⌀223 mm ø21 mm ↗77 mm ↔5 m  
EAN 4000870 941546  
**941.54**



- ◊ Anthracite ▣ Aluminium
- ◊ Antracita ▣ Aluminio
- ◊ Antracite ▣ Alluminio

- ▶ Expansion sets for easy system expansion include 3 luminaires and 5 metres of cable with 4 outputs

- ▶ Juegos de ampliación para ampliar fácilmente el sistema, con 3 luminarias y 5 metros de cable con 4 salidas

- ▶ Set di ampliamento per estendere il sistema, comprendente 3 lampade e cavo da 5 m con 4 uscite



#### Plug & Shine Spot Plantini Extension-Set

incl. 3×2,5 W  
3×200 lm, 3.000 K  
◄ 45°  
24 V  
⌀223 mm ø21 mm ↗77 mm ↔5 m  
EAN 4000870 941560  
**941.56**



- ◊ Anthracite ▣ Aluminium
- ◊ Antracita ▣ Aluminio
- ◊ Antracite ▣ Alluminio





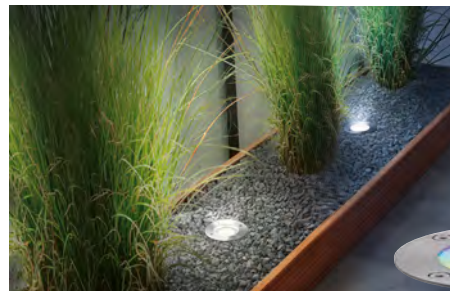

- ▶ Starter sets for the system include three luminaires, five metres of cable with four outputs and one transformer
- ▶ Extendable
- ▶ Stepless light colour control via ZigBee remote control, app or voice control
- ▶ Juegos de iniciación para iniciarse en el sistema, con 3 luminarias, 5 metros de cable con 4 salidas y un transformador
- ▶ Ampliable
- ▶ Control continuo de la tonalidad de la luz con mando a distancia ZigBee, aplicación o voz
- ▶ Starter set per familiarizzare con il sistema, comprendente 3 apparecchi di illuminazione, cavo da 5 m con 4 uscite e un trasformatore
- ▶ Ampliabili
- ▶ Comando dei colori a regolazione illimitata tramite telecomando Zigbee, app o sistema vocale



**Plug & Shine Floor Starter-Set**

incl. 3x3,7W  
 3x350 lm, 3.000 - 6.500 K  
 <math>\sphericalangle</math> 93°  
 230/24V  
 <math>\updownarrow</math>92 <math>\varnothing</math>98 mm  
 EAN 4000870 942758  
**942.75**



- <math>\sphericalangle</math> Silver <math>\boxtimes</math> Stainless steel/Plastic
- <math>\sphericalangle</math> Plateado <math>\boxtimes</math> Acero inoxidable/Plástico
- <math>\sphericalangle</math> Argento <math>\boxtimes</math> Acciaio legato/Plastica

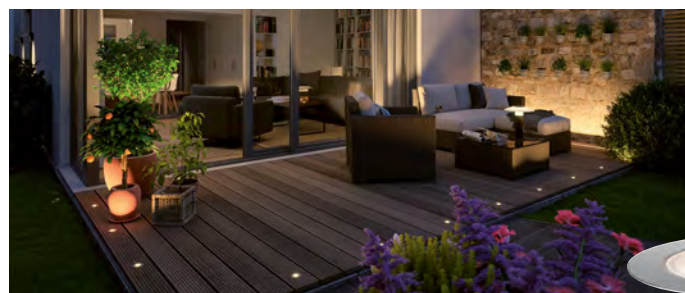

- ▶ Starter sets for the system include 3 luminaires, 5 metres of cable with 4 outputs and one transformer for optional system expansion
- ▶ Extendable
- ▶ Juegos de iniciación para iniciarse en el sistema, con 3 luminarias, 5 metros de cable con 4 salidas y un transformador para la ampliación
- ▶ Ampliable
- ▶ Starter set per familiarizzare con il sistema, comprendente 3 apparecchi di illuminazione, cavo da 5 m con 4 uscite e un trasformatore per possibilità di ampliamento
- ▶ Ampliabili



**Plug & Shine Floor Starter-Set**

incl. 3x1,4W  
 3x100 lm, 3.000 K  
 <math>\sphericalangle</math> 90°  
 230/24V, incl. <math>\boxtimes</math> 21VA  
 <math>\updownarrow</math>30 mm <math>\varnothing</math>70 mm <math>\leftrightarrow</math>5 m  
 EAN 4000870 936924  
**936.92**



- <math>\sphericalangle</math> Silver <math>\boxtimes</math> Stainless steel/Plastic
- <math>\sphericalangle</math> Plateado <math>\boxtimes</math> Acero inoxidable/Plástico
- <math>\sphericalangle</math> Argento <math>\boxtimes</math> Acciaio legato/Plastica

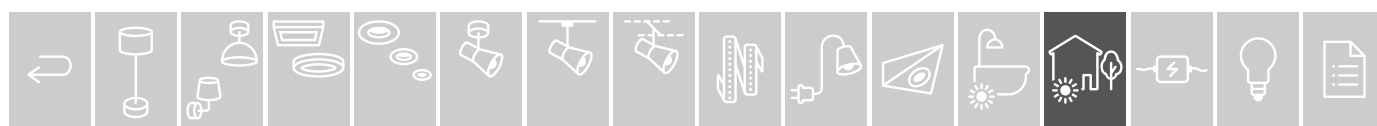



- ▶ Starter sets for the system include 3 luminaires, 5 metres of cable with 4 outputs and one transformer for optional system expansion
- ▶ Extendable

- ▶ Juegos de iniciación para iniciarse en el sistema, con 3 luminarias, 5 metros de cable con 4 salidas y un transformador para la ampliación
- ▶ Ampliable

- ▶ Starter set per familiarizzare con il sistema, comprendente 3 apparecchi di illuminazione, cavo da 5 m con 4 uscite e un trasformatore per possibilità di ampliamento
- ▶ Ampliabili



#### Plug & Shine Floor Mini Starter-Set

incl. 3x1,8W  
3x95 lm, 3.000 K  
∠ 95°  
230/24V, incl. ⚡ 21VA  
∅90 ø55 mm  
EAN 4000870 936979  
**936.97**



- 🔗 Silver 🗍 Stainless steel/Plastic
- 🔗 Plateado 🗍 Acero inoxidable/Plástico
- 🔗 Argento 🗍 Acciaio legato/Plastica

- ▶ Expansion sets for easy system expansion include 3 luminaires and 5 metres of cable with 4 outputs

- ▶ Juegos de ampliación para ampliar fácilmente el sistema, con 3 luminarias y 5 metros de cable con 4 salidas

- ▶ Set di ampliamento per estendere il sistema, comprendente 3 lampade e cavo da 5 m con 4 uscite



#### Plug & Shine Floor Mini Extension-Set

incl. 3x1,8W  
3x95 lm, 3.000 K  
∠ 95°  
24V  
∅90 mm ø55 mm ↔5 m  
EAN 4000870 939499  
**939.49**



- 🔗 Silver 🗍 Stainless steel/Plastic
- 🔗 Plateado 🗍 Acero inoxidable/Plástico
- 🔗 Argento 🗍 Acciaio legato/Plastica

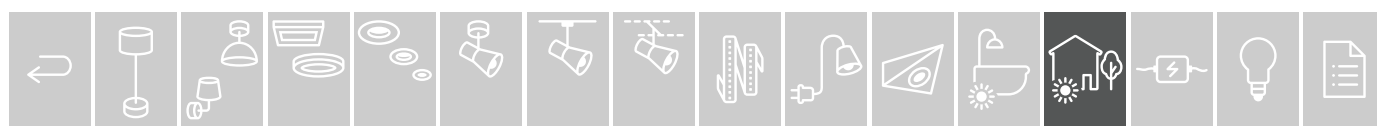

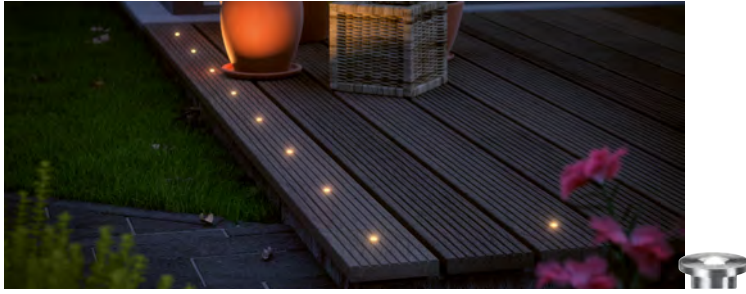

- ▶ Starter set incl. 5 luminaires and transformer
- ▶ Suitable for wood patios

- ▶ Juego de iniciación incl. 5 luminarias y transformador
- ▶ Adecuado para terrazas de madera

- ▶ Starter set incl. 5 apparecchi e trasformatore
- ▶ Adatto per terrazze in legno



**Plug & Shine MicroPen II Starter-Set**

incl. 5x0,22 W  
 5x3 lm, 3.000 K  
 <math>\sphericalangle</math> 22°  
 230/24 V, incl. ⚡ 21 VA  
 ø15 mm  
 EAN 4000870 936955  
**936.95**



- 🔩 Silver 🗄️ Stainless steel
- 🔩 Plateado 🗄️ Acero inoxidable
- 🔩 Argento 🗄️ Acciaio legato

- ▶ Expansion sets for easy system expansion include 5 luminaires

- ▶ Juegos de ampliación para ampliar fácilmente el sistema, con 5 luminarias

- ▶ Set di ampliamento per estendere il sistema, comprendente 5 lampade



**Plug & Shine MicroPen II Extension-Set**

incl. 5x0,22 W  
 5x3 lm, 3.000 K  
 <math>\sphericalangle</math> 22°  
 24 V  
 ø15 mm  
 EAN 4000870 936948  
**936.94**



- 🔩 Silver 🗄️ Stainless steel
- 🔩 Plateado 🗄️ Acero inoxidable
- 🔩 Argento 🗄️ Acciaio legato

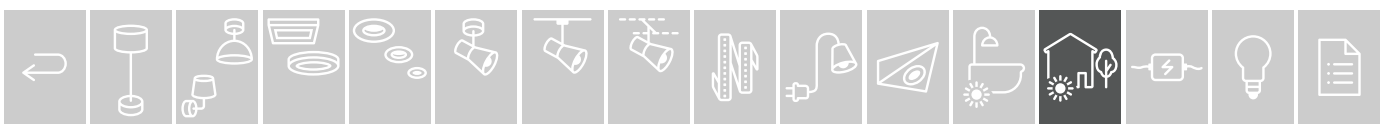

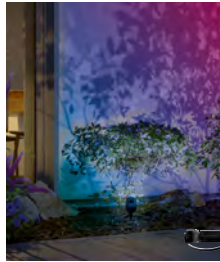

- ▶ Perfect for atmospheric spotlighting of plants or objects
- ▶ Ground spike for easy installation in any garden
- ▶ Stepless light colour control via ZigBee remote control, app or voice control
- ▶ Ideal para la iluminación sugerente de plantas u objetos
- ▶ Estaca para la instalación flexible en cualquier jardín
- ▶ Control continuo de la tonalidad de la luz con mando a distancia ZigBee, aplicación o voz
- ▶ Ideale per illuminare piante o oggetti
- ▶ Paletto per un'installazione flessibile in ogni giardino
- ▶ Comando dei colori a regolazione illimitata tramite telecomando Zigbee, app o sistema vocale

**Plug & Shine Spot Pike**

incl. 1x4,2 W  
330 lm, 3.000 – 6.500 K  
24 V  
⌀313 ø50 ⌀82 mm  
EAN 4000870 942833  
**942.83**



☞ Anthracite ☒ Plastic  
☞ Antracita ☒ Plástico  
☞ Antracite ☒ Plastica

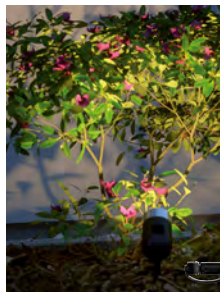

- ▶ With 45° beam angle ideal for spotlighting plants or objects
- ▶ Ground spike for easy installation in any garden
- ▶ Con un ángulo de irradiación de 45°, ideal para iluminar plantas u objetos
- ▶ Estaca para la instalación flexible en cualquier jardín
- ▶ Con angolo emissione a 45°, ideale per illuminare piante o oggetti
- ▶ Paletto per un'installazione flessibile in ogni giardino

**Plug & Shine Spot Pike**

incl. 1x2,3 W  
370 lm, 3.000 K  
◄ 45°  
24 V  
⌀313 ø50 ⌀82 mm  
EAN 4000870 942413  
**942.41**



☞ Anthracite ☒ Plastic  
☞ Antracita ☒ Plástico  
☞ Antracite ☒ Plastica

- ▶ Perfect for illuminating bushes and flower beds
- ▶ Ideal para la iluminación de arbustos y parterres
- ▶ Ideale per l'illuminazione di alberi e aiuole

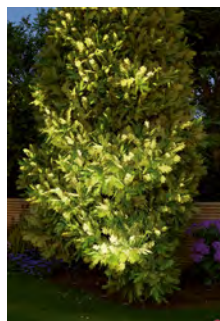
**Plug & Shine Spot Sting**

incl. 1x6,4 W  
520 lm, 3.000 K  
◄ 100°  
24 V  
⌀290 ø52 mm  
EAN 4000870 939345  
**939.34**

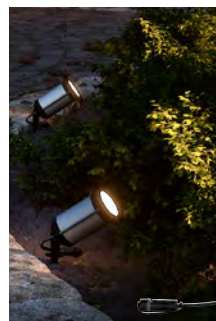

☞ Anthracite ☒ Aluminium  
☞ Antracita ☒ Aluminio  
☞ Antracite ☒ Alluminio

**Plug & Shine Spot Classic**

incl. 1x5,1 W  
310 lm, 3.000 K  
◄ 32°  
24 V  
⌀265 ø88 mm  
EAN 4000870 942857  
**942.85**



☞ Anthracite ☒ Metal  
☞ Antracita ☒ Metal  
☞ Antracite ☒ Metallo

- ▶ Small, flexible garden spot for lighting accents in flower beds or planters
- ▶ Foco de jardín pequeño y flexible para acentos luminosos en parterres o macetas
- ▶ Piccolo spot da giardino flessibile per acenti luminosi in aiuole o vasi

**Plug & Shine Spot Plantini**

incl. 1x1,4 W  
200 lm, 3.000 K  
◄ 45°  
24 V  
⌀223 ø21 ⌀77 mm  
EAN 4000870 939970  
**939.97**



☞ Anthracite ☒ Aluminium  
☞ Antracita ☒ Aluminio  
☞ Antracite ☒ Alluminio



- ▶ Underwater spot IP68 for ponds – installation under water by means of metal plate
- ▶ Foco subacuático IP68 para la instalación bajo el agua en estanques mediante placas de metal
- ▶ Spot subacquei IP68 per stagni – Installazione sott'acqua grazie a piattelli metallici



**Plug & Shine Underwater Spot**

incl. 1x2,8 W  
400 lm, 3.000 K  
◄ 25°  
24 V  
⌀120 ø200 mm  
EAN 4000870 942093  
**942.09**

- 🔗 Black 

--	--	--

 Aluminium
  - 🔗 Negro 

--	--	--

 Aluminio
  - 🔗 Nero 

--	--	--

 Alluminio
- IP68  
rost frei

- ▶ Plug & Shine floodlight for high-powered illumination of objects or façades
- ▶ Bañador Plug & Shine para la iluminación potente de objetos o fachadas
- ▶ Proiettore Plug & Shine per un'illuminazione potente di edifici o facciate
- ▶ With earth spike for placement flexibility
- ▶ Incluye estaca de montaje para la disposición flexible
- ▶ Incluso picchetto di montaggio per una disposizione flessibile

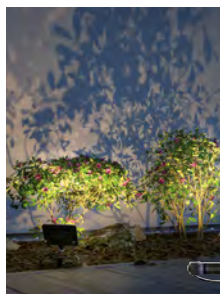

**Plug & Shine Flood Spot**

incl. 1x6,8 W  
650 lm, 3.000 K  
24 V  
⌀103 ⇄103 ⚡23 mm  
EAN 4000870 945742  
**945.74 new**

- 🔗 Black 

--	--	--

 Aluminium
  - 🔗 Negro 

--	--	--

 Aluminio
  - 🔗 Nero 

--	--	--

 Alluminio
- IP65  
rost frei

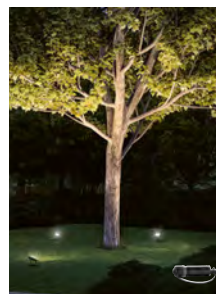

**Plug & Shine Flood Spot**

incl. 1x15,5 W  
1.700 lm, 3.000 K  
24 V  
⌀145 ⇄160 ⚡26 mm  
EAN 4000870 945759  
**945.75 new**

- 🔗 Black 

--	--	--

 Aluminium
  - 🔗 Negro 

--	--	--

 Aluminio
  - 🔗 Nero 

--	--	--

 Alluminio
- IP65  
rost frei

- ▶ Plug & Shine recessed floor luminaires for the efficient illumination of plants and objects from ground level
- ▶ Luminaria empotrable en el suelo Plug & Shine para la iluminación eficiente de plantas y objetos desde el suelo
- ▶ Faretto da incasso a pavimento Plug & Shine per un'illuminazione efficiente di piante e oggetti dal terreno
- ▶ Stepless light colour control via ZigBee remote control, app or voice control
- ▶ Control continuo de la tonalidad de la luz con mando a distancia ZigBee, aplicación o voz
- ▶ Comando dei colori a regolazione illimitata tramite telecomando Zigbee, app o sistema vocale

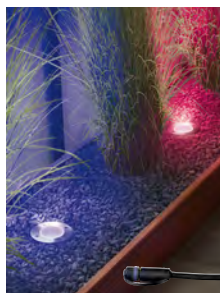

**Plug & Shine Floor**

incl. 1x3,7 W  
350 lm, 3.000 - 6.500 K  
◄ 93°  
24 V  
⌀92 ø96 mm  
EAN 4000870 942741  
**942.74**

- 🔗 Silver 

--	--	--

 Stainless steel/Plastic
  - 🔗 Plateado 

--	--	--

 Acero inoxidable/Plástico
  - 🔗 Argento 

--	--	--

 Acciaio legato/Plastica
- tunable white  
IP65  
rost frei  
zigbee

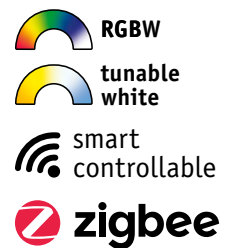

- ▶ Easy mounting with the installation sleeve provided
- ▶ Montaje sencillo mediante manguito de instalación incluido
- ▶ Montaggio semplice mediante la boccia a incasso fornita
- ▶ Suitable for installation on patios and in the soil
- ▶ Adecuado para terraza y suelo
- ▶ Adatto a terrazza e terreno



**Plug & Shine Floor Mini**

incl. 1x1,8 W  
95 lm, 3.000 K  
◄ 95°  
24 V  
⌀90 ø55 mm  
EAN 4000870 939512  
**939.51**

- 🔗 Silver 

--	--	--

 Stainless steel/Plastic
  - 🔗 Plateado 

--	--	--

 Acero inoxidable/Plástico
  - 🔗 Argento 

--	--	--

 Acciaio legato/Plastica
- IP65  
rost frei  
Kg  
500





- ▶ Easy mounting with attachment clips
- ▶ Suitable for wood and stone patios
- ▶ Montaje sencillo con abrazaderas de sujeción
- ▶ Adecuado para terrazas de madera y piedra
- ▶ Montaggio semplice mediante cavo di fissaggio
- ▶ Adatto per terrazze in legno e pietra



**Plug & Shine Floor**

incl. 1x1,4 W  
 100 lm, 3.000 K  
 <math>\sphericalangle</math> 90°  
 24 V  
 <math>\updownarrow</math>30 <math>\varnothing</math>70 mm  
 EAN 4000870 939536  
**939.53**

Silver Stainless steel/Plastic  
 Plateado Acero inoxidable/Plástico  
 Argento Acciaio legato/Plastica

Kg 100

- ▶ Perfect for the illumination of trees or façades
- ▶ Targeted illumination with defined beam angle
- ▶ Perfect illumination due to swivel capability
- ▶ Sunken light source for shielded lighting
- ▶ Unencumbered lawn mowing
- ▶ Ideal para la iluminación de árboles o fachadas
- ▶ Iluminación precisa gracias al ángulo de irradiación definido
- ▶ Iluminación perfecta gracias a la posibilidad de orientación
- ▶ Sin deslumbramiento gracias a la fuente de luz empotrada
- ▶ Cortar el césped sin dificultades
- ▶ Ideale per l'illuminazione di alberi o facciate
- ▶ Illuminazione mirata grazie all'angolo emissione ben definito
- ▶ Illuminazione perfetta, grazie alla possibilità di orientarli
- ▶ Antiriflesso, grazie alla fonte luminosa abbassata
- ▶ Rasatura del prato senza ostacoli

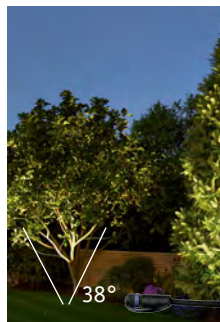

**Plug & Shine Floor**

incl. 1x4,5 W  
 609 lm, 3.000 K  
 <math>\sphericalangle</math> 38°  
 24 V  
 <math>\updownarrow</math>150 <math>\varnothing</math>140 mm  
 EAN 4000870 939086  
**939.08**

Silver Metal  
 Plateado Metal  
 Argento Metallo

Kg 500

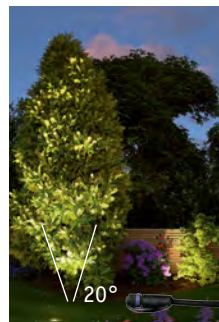

**Plug & Shine Floor**

incl. 1x4,5 W  
 609 lm, 3.000 K  
 <math>\sphericalangle</math> 20°  
 24 V  
 <math>\updownarrow</math>150 <math>\varnothing</math>140 mm  
 EAN 4000870 939079  
**939.07**

Silver Metal  
 Plateado Metal  
 Argento Metallo

Kg 500



- ▶ Plug & Shine recessed floor luminaires for the efficient illumination of plants and objects from ground level
- ▶ Luminaria empotrable en el suelo Plug & Shine para la iluminación eficiente de plantas y objetos desde el suelo
- ▶ Faretto da incasso a pavimento Plug & Shine per un'illuminazione efficiente di piante e oggetti dal terreno



**Plug & Shine Floor**

incl. 1x3,8 W  
 450 lm, 3.000 K  
 24 V  
 <math>\updownarrow</math>91 <math>\varnothing</math>98 mm  
 EAN 4000870 942284  
**942.28**

Stainless steel Metal/Plastic  
 Acero inoxidable Metal/Plástico  
 Acciaio legato Metallo/Plastica



**Plug & Shine Floor**

incl. 1x3,8 W  
 450 lm, 3.000 K  
 24 V  
 <math>\updownarrow</math>91 <math>\varnothing</math>100 <math>\varnothing</math>100 mm  
 EAN 4000870 942277  
**942.27**

Stainless steel Metal/Plastic  
 Acero inoxidable Metal/Plástico  
 Acciaio legato Metallo/Plastica





- ▶ Perfect for uniform, wide-beam illumination of walls, hedges, façades and for effective highlighting of reliefs
- ▶ Sunken light source for shielded lighting
- ▶ Unencumbered lawn mowing
- ▶ Ideal para una potente iluminación con un ancho uniforme de muros, setos, paredes de casa y para poner de relieve eficaz de relieves
- ▶ Sin deslumbramiento gracias a la fuente de luz empotrada
- ▶ Cortar el césped sin dificultades
- ▶ Per un'illuminazione potente, ampia e uniforme di muri, siepi, pareti di casa e per un efficace evidenziazione di rilievi
- ▶ Antiriflesso, grazie alla fonte luminosa abbassata
- ▶ Rasatura del prato senza ostacoli

**Plug & Shine Floor**

incl. 1x7,9 W

875 lm, 3.000 K

✕ 95°

24 V

⇄ 45 ⇄ 900 ⇄ 54 mm

EAN 4000870 939215

**939.21**



- 🔩 Anthracite 🏠 Die cast aluminium
- 🔩 Antracita 🏠 Aluminio inyectado a presión
- 🔩 Antracite 🏠 Alluminio pressofuso



- ▶ Perfect for uniform, wide-beam illumination of walls, hedges, façades and for effective highlighting of reliefs
- ▶ Swivelling
- ▶ Framelessly linkable for uniform illumination of larger areas
- ▶ Ideal para una potente iluminación con un ancho uniforme de muros, setos, paredes de casa y para poner de relieve eficaz de relieves
- ▶ Orientable
- ▶ Concatenable sin marco para una iluminación uniforme de superficies largas
- ▶ Per un'illuminazione potente, ampia e uniforme di muri, siepi, pareti di casa e per un efficace evidenziazione di rilievi
- ▶ Orientabile
- ▶ Applicabile senza telaio per illuminazione uniforme di superfici lunghe

**Plug & Shine Floor**

incl. 1x8,1 W

875 lm, 3.000 K

✕ 115°

24 V

⇄ 58 ⇄ 856 ⇄ 52 mm

EAN 4000870 939222

**939.22**



- 🔩 Anthracite 🏠 Die cast aluminium
- 🔩 Antracita 🏠 Aluminio inyectado a presión
- 🔩 Antracite 🏠 Alluminio pressofuso

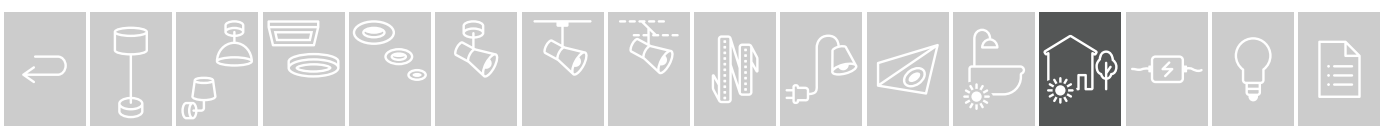

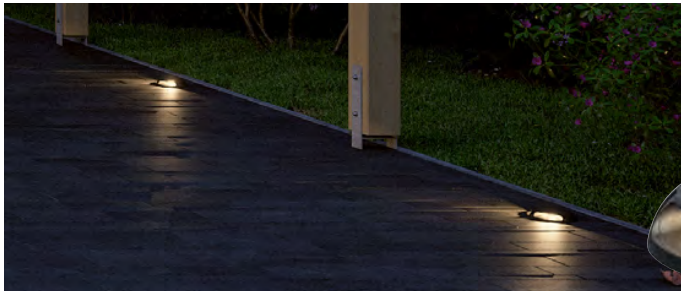

- ▶ Perfect for driveway illumination
- ▶ Strip lighting for glare-free illumination
- ▶ Extra heavy quality
- ▶ Drive-over surface
- ▶ Ideal para la iluminación de la entrada
- ▶ Sin deslumbramiento gracias a la sugerente luz rasante
- ▶ Calidad extremadamente robusta
- ▶ Transitable
- ▶ Ideali per l'illuminazione degli ingressi
- ▶ Senza effetto abbagliante grazie all'efficace striscia di luce
- ▶ Pregiatissima qualità
- ▶ Carrabile



**Plug & Shine Floor**

incl. 2x3,3 W  
 2x350 + 350lm, 3.000 K  
 <math>\sphericalangle</math> 180°  
 24 V  
 <math>\updownarrow</math>32 <math>\varnothing</math>160 mm  
 EAN 4000870 939208  
**939.20**



- ☞ Anthracite ☒ Die cast aluminium
- ☞ Antracita ☒ Aluminio inyectado a presión
- ☞ Antracite ☒ Alluminio pressofuso



- ▶ Perfect for no-glare footpath illumination
- ▶ Ideal para la iluminación de caminos sin deslumbramiento
- ▶ Ideale per illuminazione di strade antiriflesso



**Plug & Shine Path**

incl. 2x3,3 W  
 2x350 + 350lm, 3.000 K  
 <math>\sphericalangle</math> 180°  
 24 V  
 <math>\updownarrow</math>155 <math>\varnothing</math>193 mm  
 EAN 4000870 939178  
**939.17**



- ☞ Anthracite ☒ Die cast aluminium
- ☞ Antracita ☒ Aluminio inyectado a presión
- ☞ Antracite ☒ Alluminio pressofuso





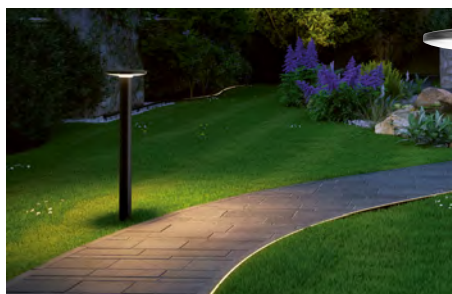

► Reliable bollard with high luminosity

► Baliza fiable con una potencia lumínica elevada

► Paletto affidabile con elevate prestazioni di illuminazione



**Plug & Shine Poller Plate**

incl. 1x6,1 W  
580 lm, 3.000 K  
24 V  
⌄600 ⌀159 mm  
EAN 4000870 943120  
**943.12**



- 🔗 Anthracite 🏠 Plastic
- 🔗 Antracita 🏠 Plástico
- 🔗 Antracite 🏠 Plastica

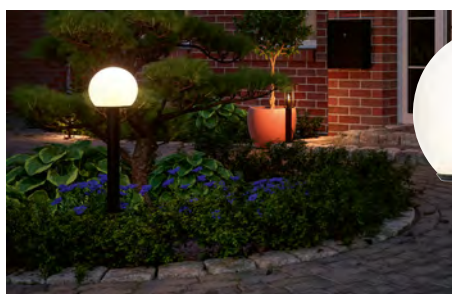

- Classic bollard lights with dimmable warm white 24 V filament lamps
- Omnidirectional illumination for paths, squares and flower bed borders

- Balizas clásicas con lámparas de filamento regulables de 24 V en blanco cálido
- Radiación en todas las direcciones para la iluminación de plazas o parterres

- Paletti d'illuminazione classici con lampada a filamento da 24 V dimmerabile bianco caldo
- Emissione a 360° per l'illuminazione di punti specifici o aiuole



**Plug & Shine Classic Globe**

incl. 1x2 W, E14  
160 lm, 3.000 K  
24 V  
⌄800 ⌀200 mm  
EAN 4000870 943212  
**943.21**



- 🔗 Anthracite 🏠 Metal
- 🔗 Antracita 🏠 Metal
- 🔗 Antracite 🏠 Metallo

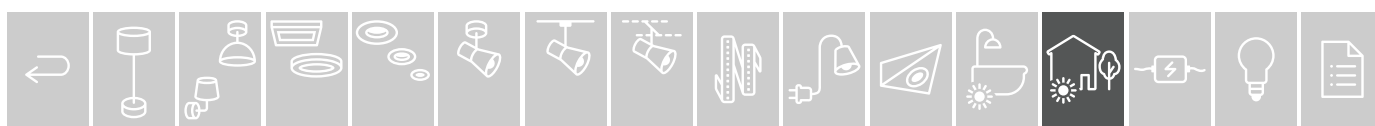

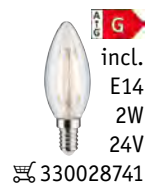
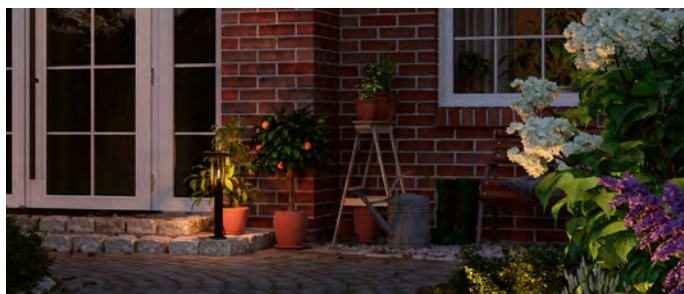

- ▶ Classic bollard lights with dimmable warm white 24 V filament lamps
- ▶ Omnidirectional illumination for paths, squares and flower bed borders

- ▶ Balizas clásicas con lámparas de filamento regulables de 24 V en blanco cálido
- ▶ Radiación en todas las direcciones para la iluminación de plazas o parterres

- ▶ Paletti d'illuminazione classici con lampada a filamento da 24 V dimmerabile bianco caldo
- ▶ Emissione a 360° per l'illuminazione di punti specifici o aiuole

**Plug & Shine Poller Classic**

incl. 1x2W, E14  
160lm, 3.000 K  
24V  
±500 ø172 mm  
EAN 4000870 943229

**943.22**

- 🔧 Anthracite 🏠 Metal
- 🔧 Antracita 🏠 Metal
- 🔧 Antracite 🏠 Metallo



- ▶ Classic bollard lights with dimmable warm white 24 V filament lamps
- ▶ Omnidirectional illumination for paths, squares and flower bed borders

- ▶ Balizas clásicas con lámparas de filamento regulables de 24 V en blanco cálido
- ▶ Radiación en todas las direcciones para la iluminación de plazas o parterres

- ▶ Paletti d'illuminazione classici con lampada a filamento da 24 V dimmerabile bianco caldo
- ▶ Emissione a 360° per l'illuminazione di punti specifici o aiuole

**Plug & Shine Mini Poller Classic**

incl. 1x2W, E14  
160lm, 3.000 K  
24V  
±220 ø80 mm  
EAN 4000870 943236

**943.23**

- 🔧 Anthracite 🏠 Metal
- 🔧 Antracita 🏠 Metal
- 🔧 Antracite 🏠 Metallo

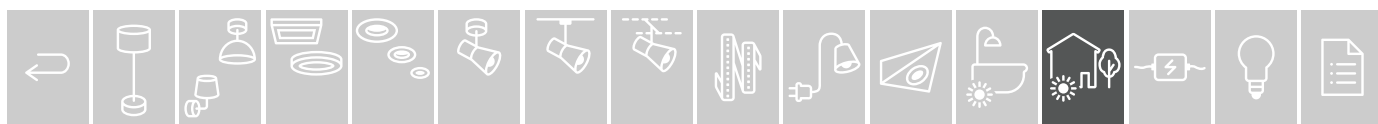



- ▶ Understated light stick for illumination along paths and flower beds
- ▶ Ground spike for easy installation in any garden
- ▶ Varilla de luz discreta para aplicaciones de iluminación en caminos y parterres
- ▶ Estaca para la instalación flexible en cualquier jardín
- ▶ Asta luminosa discreta per applicazioni di illuminazione di vialetti e aiuole
- ▶ Paletto per un'installazione flessibile in ogni giardino



**Plug & Shine PIM 360**

incl. 1x5,5 W  
490 lm, 3.000 K  
24 V  
∅360 ∅20 mm  
EAN 4000870 945308



- 945.30 new**
- 🔩 Anthracite 📦 Aluminium/Plastic
  - 🔩 Antracita 📦 Aluminio/Plástico
  - 🔩 Antracite 📦 Alluminio/Plastica



incl.

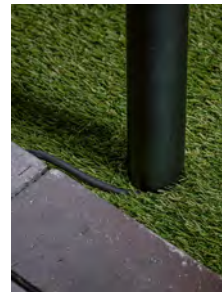

incl.



- ▶ Perfect for the illumination of paths, squares and flower bed borders
- ▶ Ground spike for easy installation in soft ground
- ▶ Ideales para la iluminación de caminos, plazas o delimitaciones de parterres
- ▶ Estaca para la fijación sencilla en suelos blandos
- ▶ Ideale per l'illuminazione di vialetti, punti specifici o aiuole
- ▶ Picchetto per un fissaggio semplice in terreni morbidi



**Plug & Shine Flarea 200**

incl. 1x3,6 W  
270 lm, 3.000 K  
24 V  
∅200 ∅45 mm  
EAN 4000870 945339



- 945.33 new**
- 🔩 Black 📦 Metal
  - 🔩 Negro 📦 Metal
  - 🔩 Nero 📦 Metallo



**Plug & Shine Flarea 400**

incl. 1x3,6 W  
270 lm, 3.000 K  
24 V  
∅400 ∅45 mm  
EAN 4000870 945360



- 945.36 new**
- 🔩 Black 📦 Metal
  - 🔩 Negro 📦 Metal
  - 🔩 Nero 📦 Metallo



**Plug & Shine Flarea 600**

incl. 1x3,6 W  
270 lm, 3.000 K  
24 V  
∅600 ∅45 mm  
EAN 4000870 945377



- 945.37 new**
- 🔩 Black 📦 Metal
  - 🔩 Negro 📦 Metal
  - 🔩 Nero 📦 Metallo

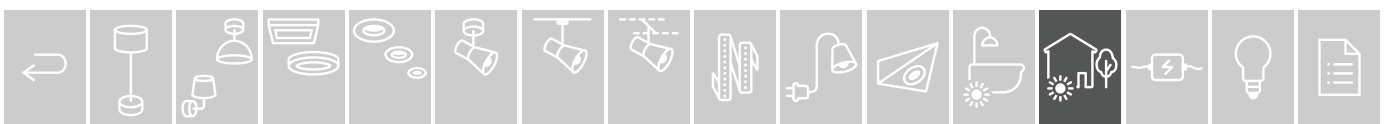



- ▶ Light objects for the atmospheric illumination of gardens and patios
- ▶ Stepless light colour control via ZigBee remote control, app or voice control
- ▶ Objetos de luz para la iluminación sugerente del jardín y la terraza
- ▶ Control continuo de la tonalidad de la luz con mando a distancia ZigBee, aplicación o voz
- ▶ Oggetti luminosi per un'illuminazione suggestiva di giardini e terrazzi
- ▶ Comando dei colori a regolazione illimitata tramite telecomando Zigbee, app o sistema vocale

**Plug & Shine Cube**

incl. 1x2,8 W  
180 lm, 3.000 - 6.500 K  
24 V  
∅200 ⇔200 ↗200 mm  
EAN 4000870 942680

**942.68**

🔗 White 📦 Plastic  
🔗 Blanco 📦 Plástico  
🔗 Bianco 📦 Plastica

**Plug & Shine Globe**

incl. 1x2,8 W  
180 lm, 3.000 - 6.500 K  
24 V  
∅200 mm  
EAN 4000870 942697

**942.69**

🔗 White 📦 Plastic  
🔗 Blanco 📦 Plástico  
🔗 Bianco 📦 Plastica

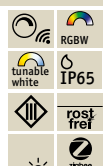

- ▶ Light objects for the atmospheric illumination of gardens and patios
- ▶ Objetos de luz para la iluminación sugerente del jardín y la terraza
- ▶ Oggetti luminosi per un'illuminazione suggestiva di giardini e terrazzi

**Plug & Shine Globe**

incl. 1x2,8 W  
235 lm, 3.000 K  
24 V, ∅200 mm  
EAN 4000870 941775

**941.77**

🔗 White 📦 Plastic  
🔗 Blanco 📦 Plástico  
🔗 Bianco 📦 Plastica

**Plug & Shine Globe**

incl. 1x6,5 W  
575 lm, 3.000 K  
24 V, ∅400 mm  
EAN 4000870 941782

**941.78**

🔗 White 📦 Plastic  
🔗 Blanco 📦 Plástico  
🔗 Bianco 📦 Plastica

**Plug & Shine Globe**

incl. 1x6,5 W  
575 lm, 3.000 K  
24 V, ∅500 mm  
EAN 4000870 941799

**941.79**

🔗 White 📦 Plastic  
🔗 Blanco 📦 Plástico  
🔗 Bianco 📦 Plastica





**Plug & Shine Stone**

incl. 1x2,8W  
235 lm, 3.000 K  
24 V  
∅166 ∅280 mm  
EAN 4000870 941751



- 👉 White 📦 Plastic
- 👉 Blanco 📦 Plástico
- 👉 Bianco 📦 Plastica



**Plug & Shine Stone**

incl. 1x2,8W  
235 lm, 3.000 K  
24 V  
∅194 ∅350 mm  
EAN 4000870 941768



- 👉 White 📦 Plastic
- 👉 Blanco 📦 Plástico
- 👉 Bianco 📦 Plastica

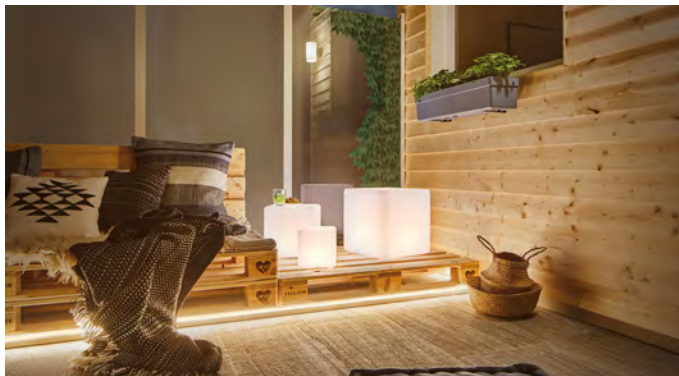

**Plug & Shine Cube**

incl. 1x2,8W  
235 lm, 3.000 K  
24 V  
∅200 ↔200 ↗200 mm  
EAN 4000870 941805



- 👉 White 📦 Plastic
- 👉 Blanco 📦 Plástico
- 👉 Bianco 📦 Plastica



**Plug & Shine Cube**

incl. 1x6,5W  
575 lm, 3.000 K  
24 V  
∅300 ↔300 ↗300 mm  
EAN 4000870 941812



- 👉 White 📦 Plastic
- 👉 Blanco 📦 Plástico
- 👉 Bianco 📦 Plastica



**Plug & Shine Star**

incl. 1x2,6W  
235 lm, 3.000 K  
24 V  
∅100 ∅400 mm  
EAN 4000870 941843



- 👉 White 📦 Plastic
- 👉 Blanco 📦 Plástico
- 👉 Bianco 📦 Plastica



**Plug & Shine Tree**

incl. 1x2W  
260 lm, 3.000 K  
24 V  
∅490 ↔280 ↗140 mm  
EAN 4000870 941850



- 👉 White 📦 Plastic
- 👉 Blanco 📦 Plástico
- 👉 Bianco 📦 Plastica



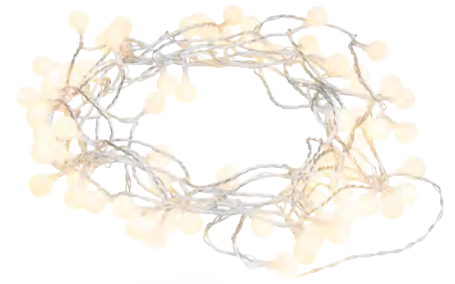
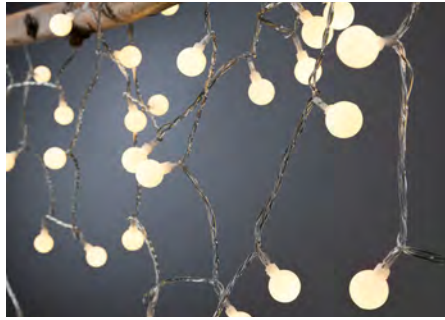

► Light chains for flexible, decorative auxiliary lighting in the garden, in seating areas or on the patio

► Cadenas de luces para la iluminación adicional, flexible y decorativa del jardín, en grupos de asientos o en la terraza

► Catene luminose per illuminazione aggiuntiva flessibile e decorativa in giardino, sulle sedute o in terrazza

**Plug & Shine Light Chain**

incl. 1,8 W, 48x

3.000 K

24 V

ø18 mm ⇔ 5 m

EAN 4000870 945582

**945.58 new**

🔗 Black 📦 Plastic  
 🔗 Negro 📦 Plástico  
 🔗 Nero 📦 Plastica

**Plug & Shine Light Chain**

incl. 2 W, 72x

3.000 K

24 V

ø18 mm ⇔ 7,5 m

EAN 4000870 945575

**945.57 new**

🔗 Black 📦 Plastic  
 🔗 Negro 📦 Plástico  
 🔗 Nero 📦 Plastica

**Plug & Shine Lightchain**

incl. 7x0,2 W

7x25 lm

24 V

ø50 mm ⇔ 6,8 m

EAN 4000870 941652

**941.65**

🔗 White 📦 Plastic  
 🔗 Blanco 📦 Plástico  
 🔗 Bianco 📦 Plastica

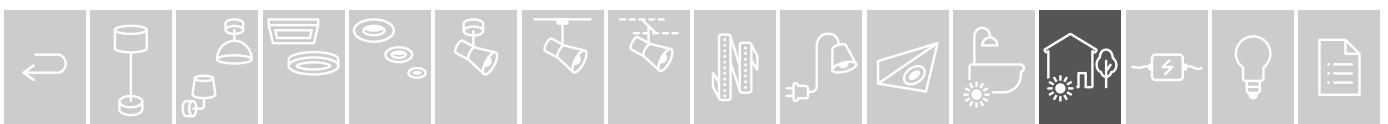





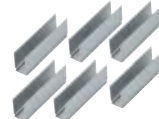



- ▶ Lighting accents for the garden and patio
- ▶ Indirect lighting of patios, stairs and flowerbeds
- ▶ Acentos de luz para el jardín y la terraza
- ▶ Iluminación indirecta de terrazas, escaleras y delimitaciones de parterres
- ▶ Accenti luminosi per giardini e terrazzi
- ▶ Illuminazione indiretta di terrazze, scale e aiuole



**Plug & Shine Smooth Strip 5m**

incl. 1x31 W  
3.050 lm, 3.000 K  
24 V  
∅14 mm ⇄9,2 mm ⇄5 m  
EAN 4000870 941911  
**941.91**

 White  Plastic  
 Blanco  Plástico  
 Bianco  Plastica







**Plug & Shine Smooth Strip Clip Set**

∅17,5 ⇄50 ⇄10,6 mm  
EAN 4000870 942154  
**942.15**





 Aluminium  Aluminium  
 Aluminio  Aluminio  
 Alluminio  Alluminio

**Plug & Shine Smooth Strip Alu Profil**

∅17,5 mm ⇄10,6 mm ⇄1 m  
EAN 4000870 942161  
**942.16**

 Aluminium  Aluminium  
 Aluminio  Aluminio  
 Alluminio  Alluminio

-  RGBW
-  tunable white
-  smart controllable
-  zigbee





**Plug & Shine Smooth 2m**

incl. 1x11 W  
1.040 lm, 3.000 K  
DC 24 V  
∅20 mm ⇄10 mm ⇄2 m  
EAN 4000870 945605  
**945.60 new**

 White  Plastic  
 Blanco  Plástico  
 Bianco  Plastica

**Plug & Shine Smooth 5m**

incl. 1x22 W  
2.600 lm, 3.000 K  
DC 24 V  
∅20 mm ⇄10 mm ⇄5 m  
EAN 4000870 945612  
**945.61 new**

 White  Plastic  
 Blanco  Plástico  
 Bianco  Plastica

**Plug & Shine Smooth 10m**

incl. 1x39 W  
5.200 lm, 3.000 K  
DC 24 V  
∅20 mm ⇄10 mm ⇄10 m  
EAN 4000870 945629  
**945.62 new**

 White  Plastic  
 Blanco  Plástico  
 Bianco  Plastica





- ▶ UV-resistant rubber strip lighting with multiple safeties
- ▶ Suitable for permanent outdoor use, protected against high mechanical stresses
- ▶ Unique, multi-seal Paulmann plug connectors
- ▶ Permanently waterproof (IP 68)
- ▶ Tubo flexible de goma con protección múltiple y resistente a los rayos UV
- ▶ Para cargas mecánicas elevadas para el uso permanente en exteriores
- ▶ Conectores Paulmann con sellado múltiple desarrollados específicamente
- ▶ Resistente al agua de forma duradera (IP 68)
- ▶ Cavo flessibile in gomma resistente ai raggi UV e dotato di più protezioni
- ▶ Per forti sollecitazioni meccaniche e utilizzo prolungato all'aperto
- ▶ Connettori a innesto appositi e con guarnizioni multiple Paulmann
- ▶ Impermeabili in modo permanente (IP 68)



Black Plastic  
 Negro Plástico  
 Nero Plastica

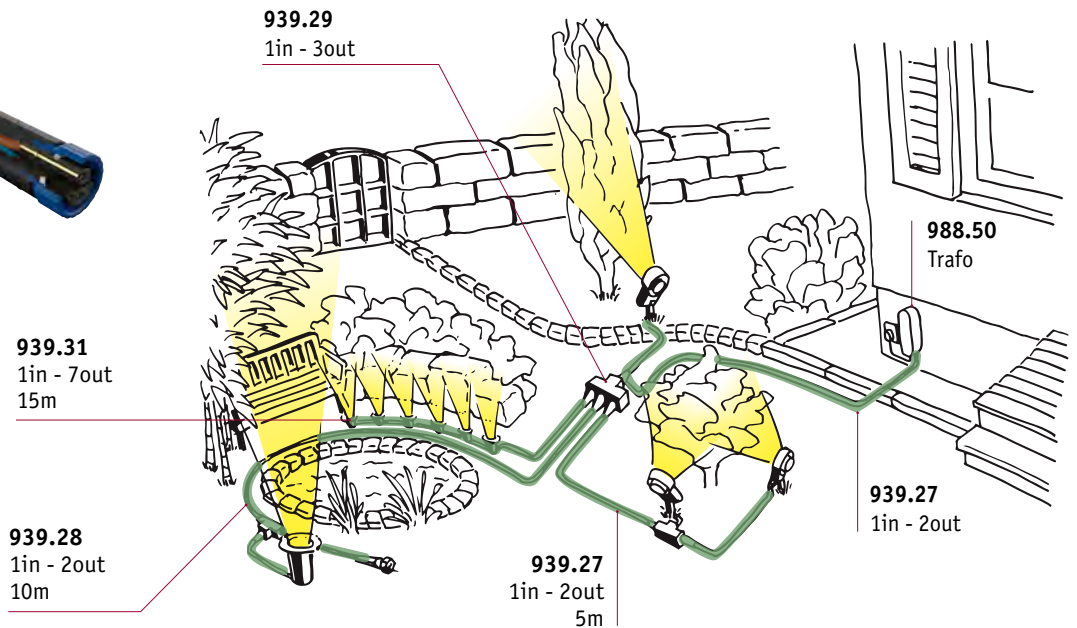

**Plug & Shine Connector 1in-3out**

max. 150 W  
 24 V  
 ⌀75 ⇄94 mm  
 EAN 4000870 939291  
**939.29**



**Plug & Shine Cable 1in-3out**

max. 150 W  
 24 V  
 ⇄1 m  
 EAN 4000870 939949  
**939.94**



**Plug & Shine Cable 1in-2out**

max. 150 W  
 24 V  
 ⇄2 m  
 EAN 4000870 939260  
**939.26**



**Plug & Shine Cable 1in-2out**

max. 150 W  
 24 V  
 ⇄5 m  
 EAN 4000870 939277  
**939.27**







**Plug & Shine Cable 1in-2out**

max. 150 W  
24 V  
↔10 m  
EAN 4000870 939284  
**939.28**



**Plug & Shine Cable 1in-5out**

max. 150 W  
24 V  
↔10 m  
EAN 4000870 939307  
**939.30**



**Plug & Shine Cable 1in-7out**

max. 150 W  
24 V  
↔15 m  
EAN 4000870 939314  
**939.31**

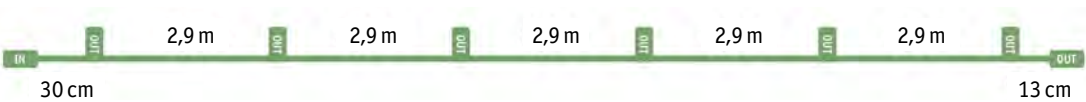

**Plug & Shine Twilight Sensor**

3xAA/1,5 V (Mignon)  
4,8 V  
↕120 ↔65 ↗40 mm  
EAN 4000870 180129  
**180.12**

Black Plastic  
Negro Plástico  
Nero Plastica



- ▶ Zigbee 3.0 switching and dimming controller for the 24V DC Plug & Shine garden luminaire system
- ▶ Easy, safe installation with Plug & Shine connector
- ▶ Suitable for all dimmable Plug & Shine luminaires
- ▶ Groups or various controllers can be operated using a single remote control.

- ▶ Controller de conmutación y regulación ZigBee 3.0 para el sistema de luminarias de jardín 24 V DC Plug&Shine
- ▶ Instalación sencilla y segura con conectores Plug&Shine
- ▶ Adecuado para todas las luminarias regulables Plug&Shine
- ▶ Posibilidad de conmutación en grupo o conmutación de varios Controller con un mando a distancia

- ▶ Interruttore ZigBee 3.0 e controller dimmerabile per sistema di luci da giardino 24V DC Plug & Shine
- ▶ Installazione semplice e sicura con connettori Plug & Shine
- ▶ Idonei per tutti gli apparecchi Plug & Shine dimmerabili
- ▶ È possibile un'accensione di gruppo o un'accensione di più controller con un telecomando.



**Plug & Shine Zigbee Controller**

max. 75 W  
24 V  
↕30 ↔260 ↗40 mm  
EAN 4000870 939994  
**939.99**

Black Plastic  
Negro Plástico  
Nero Plastica



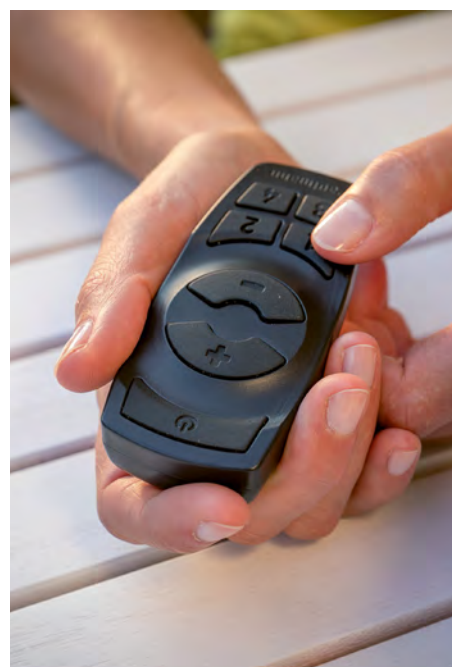
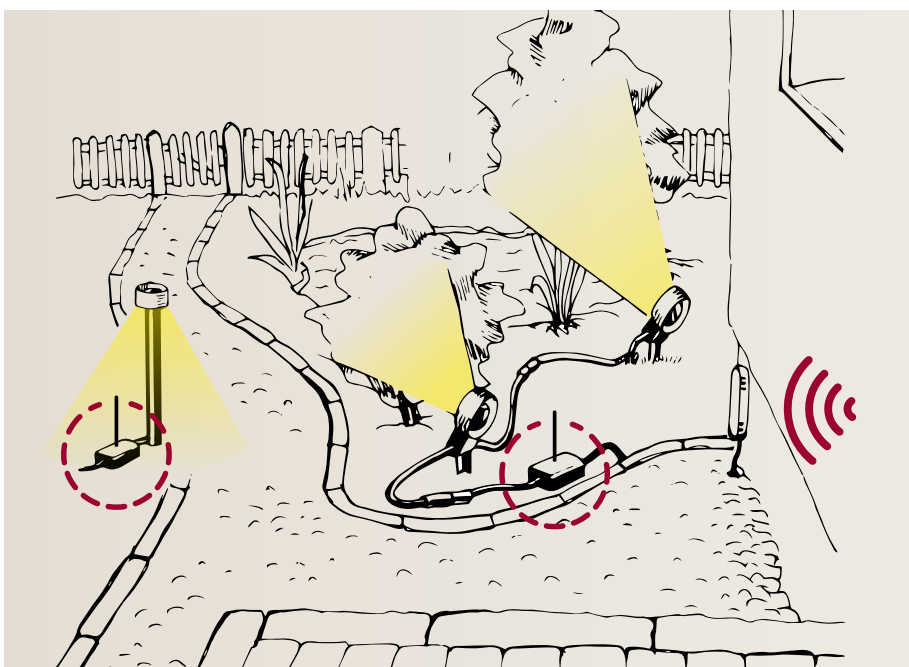

► Groups or various controllers can be operated using a single remote control.

► Posibilidad de conmutación en grupo o conmutación de varios Controller con un mando a distancia

► È possibile un'accensione di gruppo o un'accensione di più controller con un telecomando.



**Plug & Shine Controller incl. remote**

max. 75 W  
2xAAA/1,5V (Micro)  
24 V  
∅90 ⇄260 ↗40 mm  
EAN 4000870 180112

**180.11**

- 🔗 Black 🧱 Plastic
- 🔗 Negro 🧱 Plástico
- 🔗 Nero 🧱 Plastica



**Plug & Shine Controller**

max. 75 W  
24 V  
∅90 ⇄260 ↗40 mm  
EAN 4000870 180105

**180.10**

- 🔗 Black 🧱 Plastic
- 🔗 Negro 🧱 Plástico
- 🔗 Nero 🧱 Plastica

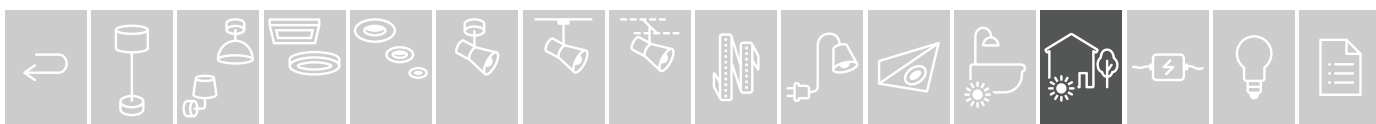



► Connector driver IP44 – perfect for the illumination of balconies and patio areas

► Controlador de conectores IP44 ideal para la iluminación del balcón y la terraza

► Stecker driver IP44 ideale per l'illuminazione di balconi e terrazzi



**Power Supply 21W IP44**  
230/24V DC

max. 21W  
230/24V, incl.  $\pm$ 21 VA  
⌀103 ⇄50 ⤴30 mm  
EAN 4000870 988480  
**988.48**



**Power Supply 75W IP44**  
230/24V DC

max. 75W  
230/24V, incl.  $\pm$ 75 VA  
⌀36 ⇄68 ⤴199 mm  
EAN 4000870 988497  
**988.49**



**Power Supply 150W IP44**  
230/24V DC

max. 150W  
230/24V, incl.  $\pm$ 150 VA  
⌀40 ⇄70 ⤴191 mm  
EAN 4000870 988503  
**988.50**



► Attractively designed transformer mounting box for harmonious integration on the exterior wall of the house

► Elegante caja de montaje para el transformador, para una integración armoniosa del transformador en la pared de casa

► Scatola di montaggio trasformatore esteticamente bella, per l'integrazione suggestiva di un trasformatore nella parete della casa

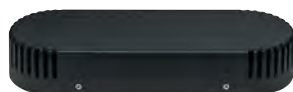

**Trafobox**  
⌀45 ⇄260 ⤴89 mm  
EAN 4000870 939048  
**939.04**

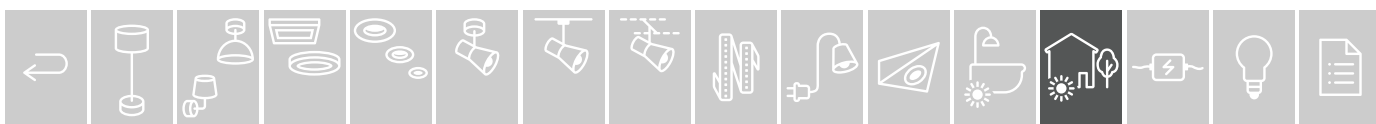



**Park + Light:**  
**The innovative 12V lighting system for carports**

The Park + Light lighting system allows for individually configurable lighting solutions for the roofs and walls of carports, garages, garden sheds and patio canopies from a single power source.

The bright wall and ceiling luminaires provide safety and orientation while loading or maintaining a vehicle, while performing repairs or tidying, or on the way to the house. The compact 12V lighting system is safe and easy to install. The IP67 rating provides maximum protection against the ingress of water. It is flexible in terms of how it can be arranged and can be added to or changed at any time.

The Park + Light luminaires can be plugged together directly or via the T-connector. Subsequent system expansions or reductions are possible at any time.

Power is supplied via a plug-in transformer (945.79, 945.80), an adapter from the Plug & Shine system (945.50), or via solar panel (945.51, 945.52).

Adding a suitable Zigbee adapter (945.55) allows the light to be controlled smartly by remote control, voice or app.

**Park + Light:**  
**El innovador sistema de iluminación de 12 V para carports**

El sistema de iluminación Park + Light permite realizar soluciones de iluminación configurables individualmente para los techos y las paredes de carports, garajes o glorietas y techos de terrazas con una única fuente de alimentación.

Los potentes apliques y plafones proporcionan seguridad y orientación al cargar o efectuar el mantenimiento del vehículo, al realizar tareas de reparación o limpieza o en el camino hacia la casa.

El sistema de iluminación compacto de 12 V es seguro y muy fácil de instalar. IP67 asegura la protección óptima contra la penetración de agua. Se puede componer y ampliar de manera flexible y modificar en cualquier momento. Las luminarias Park + Light se pueden interconectar directamente o bien ampliar con una unión en T, modificar y desmontar.

La alimentación eléctrica tiene lugar mediante un transformador de enchufe (945.79, 945.80), un adaptador del sistema Plug & Shine (945.50) o un panel solar (945.51, 945.52).

Con un correspondiente adaptador Zigbee (945.55), la luz se puede controlar de forma inteligente mediante mando a distancia, voz o aplicación.

**Park + Light:**  
**L'innovativo sistema di illuminazione da 12V per carport**

Il sistema di illuminazione Park + Light consente di realizzare soluzioni di illuminazione personalizzate per tetti e pareti di carport, garage o casette in giardino e soffitti di terrazze, il tutto con una sola fonte di corrente.

Le applique e le plafoniere garantiscono un'illuminazione intensa e, di conseguenza, sicurezza e orientamento durante le operazioni di carico o cura del veicolo, durante i lavori di riparazione o sgombero del locale, o lungo il percorso verso casa.

Il sistema di illuminazione compatto da 12V è semplicissimo da installare e sicuro. La protezione IP67 agisce con la massima efficacia contro la penetrazione di acqua. Può essere assemblato, ampliato o modificato in qualunque momento, con la massima flessibilità. Le lampade Park + Light possono essere collegate direttamente l'una all'altra o mediante un connettore a T, ampliate o ancora riconfigurate o smontate.

L'alimentazione elettrica viene assicurata mediante un trasformatore a spina (945.79, 945.80), tramite adattatore dal sistema Plug & Shine (945.50) o anche per mezzo di un pannello solare (945.51, 945.52). L'adattatore Zigbee corretto (945.55) permette di comandare la luce in modo smart mediante telecomando, comando vocale o app.

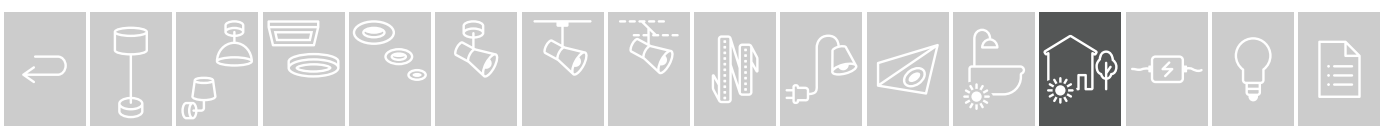
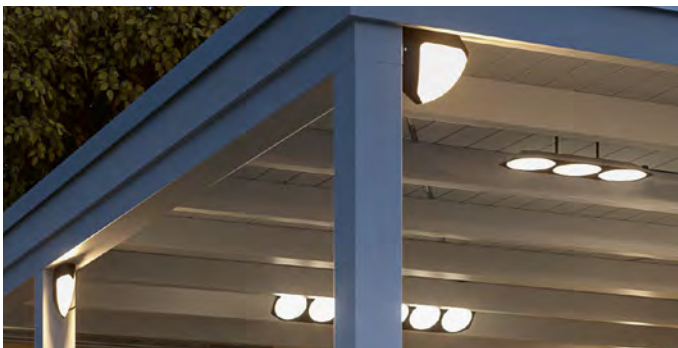
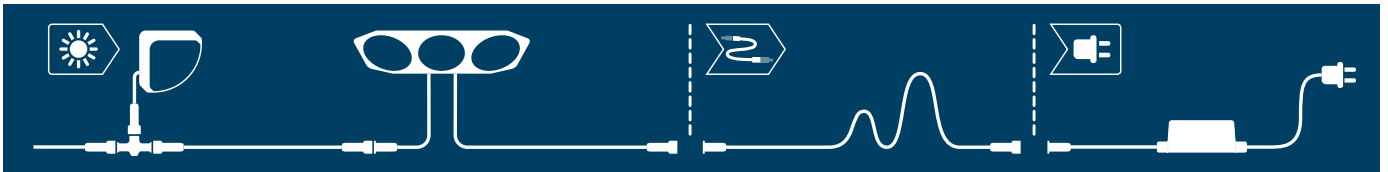



- ▶ Lighting for installation on the wall or ceiling
- ▶ 90° swivelling, adjustable light direction

- ▶ Iluminación con posibilidad de montaje en techo y paredes
- ▶ Orientables en 90° para ajustar la orientación de la luz

- ▶ Illuminazione con possibilità di montaggio a parete e su soffitto
- ▶ Orientamento della luce regolabile grazie all'angolo di rotazione di 90°

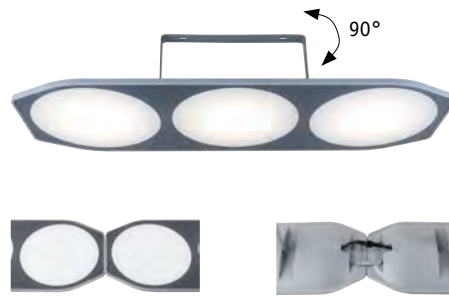

**Park + Light Route**

incl. 3x2 W  
 3x180 lm, 3.000 K  
 12 V  
 ⌀173 ⇄501 ↗111 mm  
 EAN 4000870 945100  
**945.10 new**



- ↳ Anthracite ▣ Plastic
- ↳ Antracita ▣ Plástico
- ↳ Antracite ▣ Plastica



90°  
 4-8m  
 On < 20Lux / Off > 20Lux  
 Time ON 30 sec.



**Park + Light Ikosea**

incl. 2x2,8 W  
 2x300 lm, 3.000 K  
 12 V  
 ⌀185 ⇄50 ↗203 mm  
 EAN 4000870 945186  
**945.18 new**



- ↳ Anthracite ▣ Plastic
- ↳ Antracita ▣ Plástico
- ↳ Antracite ▣ Plastica

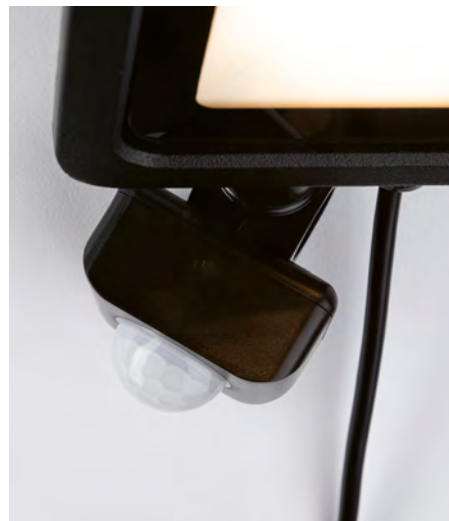

120°  
 3m  
 20Lux  
 Time ON 30 sec.



**Park + Light Bimea**

incl. 1x4,5 W  
 430 lm, 3.000 K  
 12 V  
 ⌀103 ⇄103 ↗23 mm  
 EAN 4000870 945858  
**945.85 new**



- ↳ Anthracite ▣ Plastic
- ↳ Antracita ▣ Plástico
- ↳ Antracite ▣ Plastica



**Park + Light Bimea motion detect**

incl. 1x4,5 W  
 430 lm, 3.000 K  
 12 V  
 ⌀125 ⇄103 ↗23 mm  
 EAN 4000870 945865  
**945.86 new**



- ↳ Anthracite ▣ Plastic
- ↳ Antracita ▣ Plástico
- ↳ Antracite ▣ Plastica



**Park + Light Cable 1m**

max. 24 W

↔ 1 m

EAN 4000870 945810

**945.81 new**

- 🌀 Black 🟦 Plastic
- 🌀 Negro 🟦 Plástico
- 🌀 Nero 🟦 Plastica

**Park + Light Cable 2m**

max. 24 W

↔ 2 m

EAN 4000870 945827

**945.82 new**

- 🌀 Black 🟦 Plastic
- 🌀 Negro 🟦 Plástico
- 🌀 Nero 🟦 Plastica

**Park + Light Cable 3m**

max. 24 W

↔ 3 m

EAN 4000870 945834

**945.83 new**

- 🌀 Black 🟦 Plastic
- 🌀 Negro 🟦 Plástico
- 🌀 Nero 🟦 Plastica

**Park + Light Connector**

max. 24 W

↔ 53 ↗ 38 mm

EAN 4000870 945841

**945.84 new**

- 🌀 Black 🟦 Plastic
- 🌀 Negro 🟦 Plástico
- 🌀 Nero 🟦 Plastica

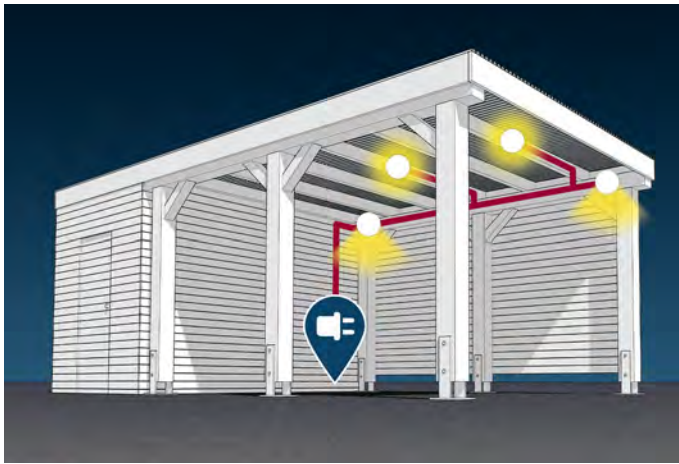
**Park + Light Power Supply**

incl. -↔- 14 VA

↕ 47 ↔ 30 ↗ 124 mm

EAN 4000870 945797

**945.79 new**

- 🌀 Black 🟦 Plastic
- 🌀 Negro 🟦 Plástico
- 🌀 Nero 🟦 Plastica

**Park + Light Power Supply**

incl. -↔- 24 VA

↕ 43 ↔ 51 ↗ 180 mm

EAN 4000870 945803

**945.80 new**

- 🌀 Black 🟦 Plastic
- 🌀 Negro 🟦 Plástico
- 🌀 Nero 🟦 Plastica



- ▶ Solar cell with battery for powering the Park + Light system without a mains connection

- ▶ Célula solar con batería para la alimentación del sistema Park + Light sin toma de corriente

- ▶ Cella solare con batteria per l'alimentazione del sistema Park + Light senza allacciamento alla corrente

**Park + Light Solar Charger**

max. 5 W

3x18650 Akku/3,7V

12 V

↕ 235 ↔ 350 ↗ 69 mm

EAN 4000870 945513

**945.51 new**

- 🌀 Silver
- 🌀 Plateado
- 🌀 Argento

**Park + Light Solar Charger**

max. 10 W

3x18650 Akku/3,7V

12 V

↕ 235 ↔ 350 ↗ 69 mm

EAN 4000870 945520

**945.52 new**

- 🌀 Silver
- 🌀 Plateado
- 🌀 Argento





- ▶ Park + Light adapter: easy integration into an existing Plug & Shine lighting system
- ▶ No additional transformer needed

- ▶ Adaptador Park + Light: conexión sencilla a un sistema de iluminación Plug & Shine existente
- ▶ No requiere ningún transformador adicional

- ▶ Adattatore Park+ Light: è sufficiente collegarlo a un sistema di illuminazione Plug & Shine già presente
- ▶ Non necessita di trasformatore aggiuntivo



**Adapter Plug & Shine > Park+Light**  
 max. 24 W  
 24 V, incl. ⚡ 24 VA  
 ⌀30 ⇄40,5 ⤴80 mm  
 EAN 4000870 945506  
**945.50 new**

- 🖨 Black 🗍 Plastic
- 🖨 Negro 🗍 Plástico
- 🖨 Nero 🗍 Plastica

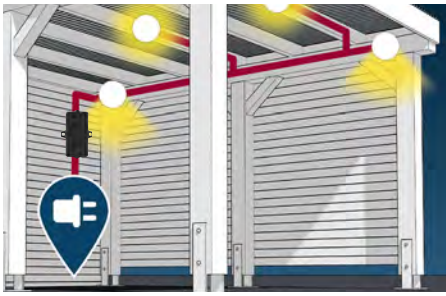

- 🕒 dimmable
- 📶 smart controllable
- 📶 zigbee



**Park + Light Smart Home Controller Zigbee**  
 max. 24 W  
 12 V  
 ⌀40 ⇄90 ⤴30 mm  
 EAN 4000870 945551  
**945.55 new**

- 🖨 Black 🗍 Plastic
- 🖨 Negro 🗍 Plástico
- 🖨 Nero 🗍 Plastica



- 👁 Sensor
- 120°
- 5m
- 20Lux
- Time ON 30 sec.



**Park + Light Sensor Motion Detect**  
 max. 24 W  
 12 V  
 ⌀40 ⇄80 ⤴57 mm  
 EAN 4000870 945568  
**945.56 new**

- 🖨 Black 🗍 Plastic
- 🖨 Negro 🗍 Plástico
- 🖨 Nero 🗍 Plastica



# House

House 230V – The reliable 230 V luminaires for light around the house

House 230V – Las eficaces luminarias de 230 V para iluminar el entorno de la casa

House 230 V – Le affidabili lampade da 230 V per ottenere luce intorno alla casa



► Precise and sharp lighting effects thanks to direct wall mounting

► Efectos lumínicos precisos y nítidos gracias al montaje directo en la pared

► Il montaggio diretto a parete consente un effetto luminoso preciso e definito

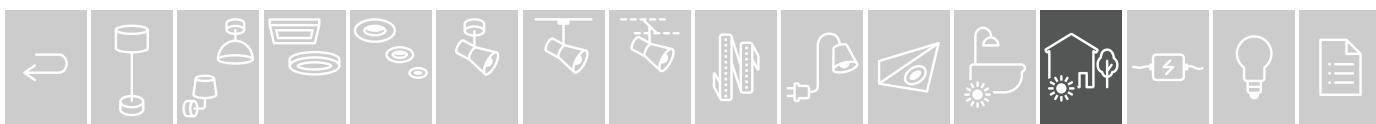



**Flame**

incl. 2×5,6 W  
2×710 lm, 3.000 K  
∠ 105°, 230 V  
∅220 ⇔102 ∇100 mm  
EAN 4000870 943250

**943.25**

- 🔗 Anthracite 📦 Aluminium
- 🔗 Antracita 📦 Aluminio
- 🔗 Antracite 📦 Alluminio

**Flame**

incl. 2×2,7 W  
2×390 lm, 3.000 K  
∠ 105°, 230 V  
∅155 ⇔65 ∇70 mm  
EAN 4000870 943267

**943.26**

- 🔗 Anthracite 📦 Aluminium
- 🔗 Antracita 📦 Aluminio
- 🔗 Antracite 📦 Alluminio

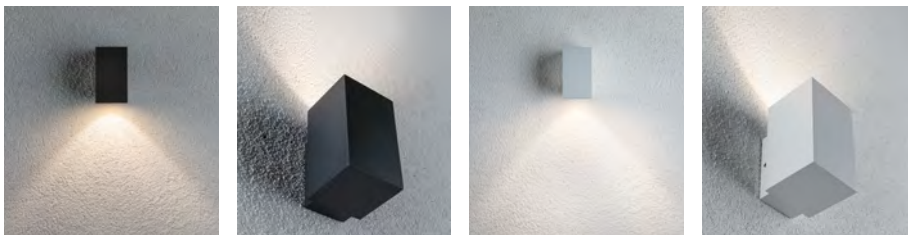
**Flame**

incl. 1×3,8 W  
450 lm, 3.000 K  
∠ 75°, 230 V  
∅103 ⇔58 ∇75 mm  
EAN 4000870 943274

**943.27**

- 🔗 Anthracite 📦 Aluminium
- 🔗 Antracita 📦 Aluminio
- 🔗 Antracite 📦 Alluminio

**Flame**

incl. 1×3,8 W  
450 lm, 3.000 K  
∠ 75°, 230 V  
∅103 ⇔58 ∇75 mm  
EAN 4000870 943298

**943.29**

- 🔗 White 📦 Aluminium
- 🔗 Blanco 📦 Aluminio
- 🔗 Bianco 📦 Alluminio

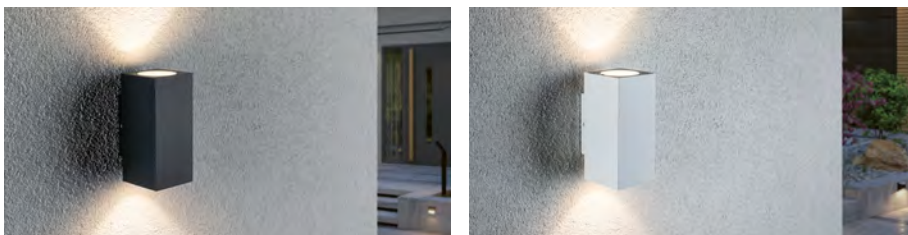
**Flame**

incl. 2×2,7 W  
2×390 lm, 3.000 K  
∠ 75°, 230 V  
∅128 ⇔58 ∇75 mm  
EAN 4000870 943281

**943.28**

- 🔗 Anthracite 📦 Aluminium
- 🔗 Antracita 📦 Aluminio
- 🔗 Antracite 📦 Alluminio

**Flame**

incl. 2×2,7 W  
2×390 lm, 3.000 K  
∠ 75°, 230 V  
∅128 ⇔58 ∇75 mm  
EAN 4000870 943304

**943.30**

- 🔗 White 📦 Aluminium
- 🔗 Blanco 📦 Aluminio
- 🔗 Bianco 📦 Alluminio

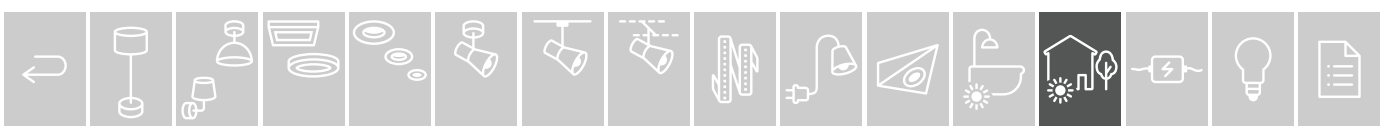

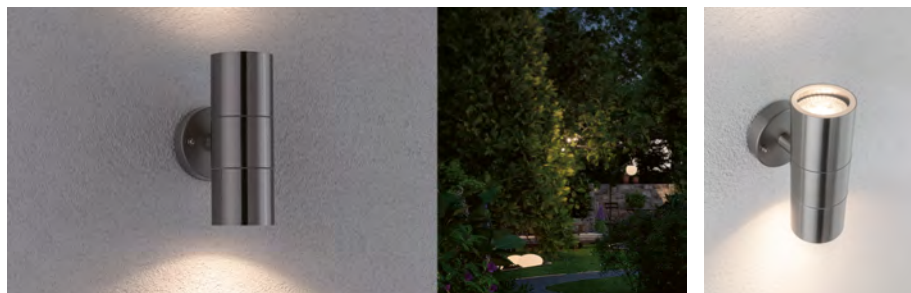

- ▶ The Flame wall luminaire series, for attractive lighting effects
- ▶ For GU10 lamps

- ▶ La serie de apliques Flame para efectos lumínicos atractivos
- ▶ Para lámparas GU10

- ▶ La gamma di applique Flame per effetti luminosi accattivanti
- ▶ Per lampadina GU10



Flame	
max. 2×10 W, GU10	⊙ IP44
230 V	⊕/⊖
↑163 ∅60 ↔73 ↗110 mm	⊕/⊖
EAN 4000870 943311	⊕/⊖
<b>943.31</b>	⊕/⊖
⊕ Brushed stainless steel ⊞ Stainless steel/Plastic	
⊕ Acero inoxidable cepillado	
⊞ Acero inoxidable/Plástico	
⊕ Acciaio legato spazzolato	
⊞ Acciaio legato/Plastica	



↘ 40-120°

- ▶ Beam angle 40-120° with folding mechanism for infinite setting options

- ▶ Ángulo de irradiación 40-120° regulable mediante un mecanismo abatible

- ▶ Angolo di irradiazione regolabile in modo variabile 40-120° grazie al meccanismo di chiusura



Cybo	
incl. 2×3 W	⊙ IP65
2×355 lm, 2.700 K	⊕/⊖
↘ 40°-120°	⊕/⊖
230 V	⊕/⊖
↑80 ↔80 ↗80 mm	⊕/⊖
EAN 4000870 180006	⊕/⊖
<b>180.00</b>	⊕/⊖
⊕ Grey ⊞ Aluminium	
⊕ Gris ⊞ Aluminio	
⊕ Grigio ⊞ Alluminio	



Cybo	
incl. 2×3 W	⊙ IP65
2×355 lm, 2.700 K	⊕/⊖
↘ 40°-120°	⊕/⊖
230 V	⊕/⊖
↑80 ↔80 ↗80 mm	⊕/⊖
EAN 4000870 180013	⊕/⊖
<b>180.01</b>	⊕/⊖
⊕ White ⊞ Aluminium	
⊕ Blanco ⊞ Aluminio	
⊕ Bianco ⊞ Alluminio	

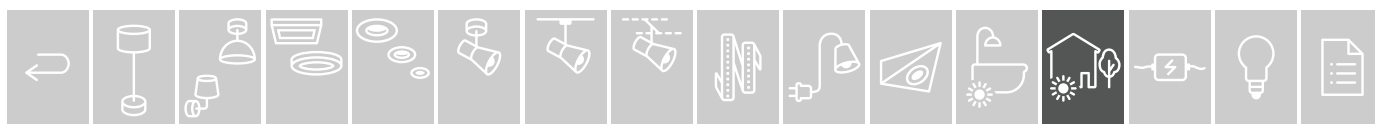



- ▶ Beam angle 85°
- ▶ Light can be rotated by up to 355°

- ▶ Ángulo de irradiación 85°
- ▶ Luz girable en 355°

- ▶ Angolo di irradiazione 85°
- ▶ Luce ruotabile a 355°

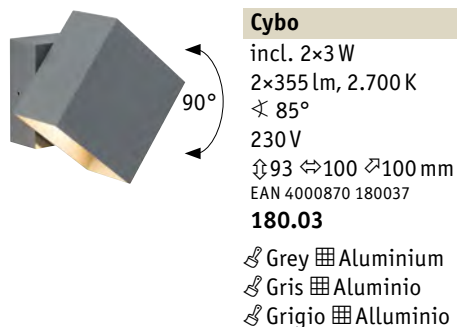
**Cybo**

incl. 2x3 W  
2x355 lm, 2.700 K  
∠ 85°  
230 V  
↑93 ↔100 ↗100 mm  
EAN 4000870 180037

**180.03**

- 🌀 Grey 📦 Aluminium
- 🌀 Gris 📦 Aluminio
- 🌀 Grigio 📦 Alluminio

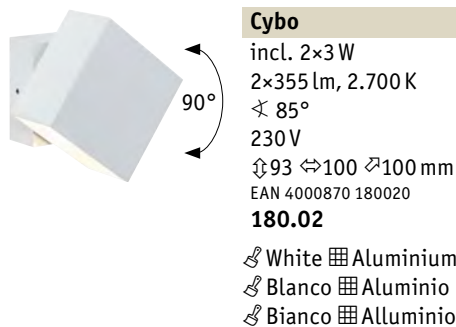
**Cybo**

incl. 2x3 W  
2x355 lm, 2.700 K  
∠ 85°  
230 V  
↑93 ↔100 ↗100 mm  
EAN 4000870 180020

**180.02**

- 🌀 White 📦 Aluminium
- 🌀 Blanco 📦 Aluminio
- 🌀 Bianco 📦 Alluminio



90°  
2-8m  
On < 20Lux / Off > 20Lux  
Time ON < 5 sec - 5 min.



- ▶ Attractive wall luminaires for façades and driveways, optionally available with motion sensor

- ▶ Atractivos apliques para la pared de la casa y los accesos, opcionalmente con detector de movimientos

- ▶ Applique accattivanti per le pareti dell'abitazione e il viale d'accesso, disponibili opzionalmente con rilevatore di movimento

**Capea**

incl. 1x6 W  
600 lm, 3.000 K  
∠ 98°  
230 V  
↑56 ↔96 ↗128 mm  
EAN 4000870 944523

**944.52 new**

- 🌀 Grey 📦 Aluminium
- 🌀 Gris 📦 Aluminio
- 🌀 Grigio 📦 Alluminio

**Capea**

incl. 1x6 W  
600 lm, 3.000 K  
∠ 98°  
230 V  
↑165 ↔96 ↗153 mm  
EAN 4000870 944530

**944.53 new**

- 🌀 Grey 📦 Aluminium
- 🌀 Gris 📦 Aluminio
- 🌀 Grigio 📦 Alluminio

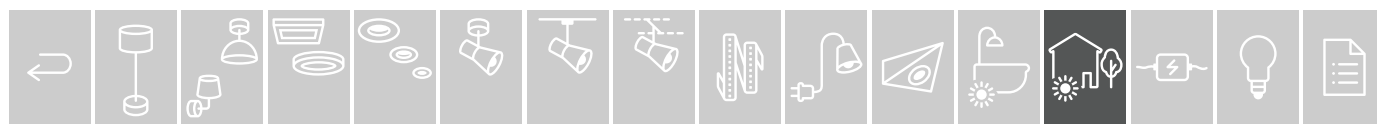

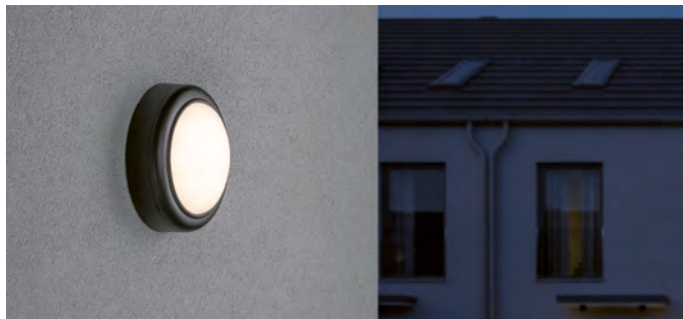

**Wall Luminaire**

incl. 1x7,6W  
800 lm, 3.000 K  
230V  
±58 ø140 mm  
EAN 4000870 941195

**941.19**

- 🔗 Grey 🗪 Plastic
- 🔗 Gris 🗪 Plástico
- 🔗 Grigio 🗪 Plastica



**Wall Luminaire**

incl. 1x15,2W  
1.500 lm, 3.000 K  
230V  
±66 ø180 mm  
EAN 4000870 941881

**941.88**

- 🔗 Grey 🗪 Plastic
- 🔗 Gris 🗪 Plástico
- 🔗 Grigio 🗪 Plastica

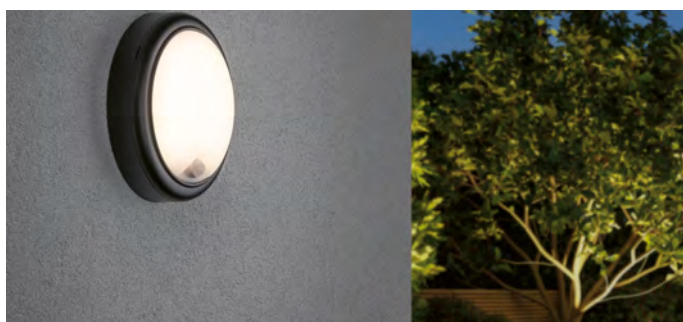

**Wall Luminaire**

incl. 1x13,8W  
1.500 lm, 3.000 K  
230V  
±66 ø180 mm  
EAN 4000870 941874

**941.87**

- 🔗 Grey 🗪 Plastic
- 🔗 Gris 🗪 Plástico
- 🔗 Grigio 🗪 Plastica



90°  
4-7m  
On < 20Lux  
Off > 20Lux  
Time ON < 30sec

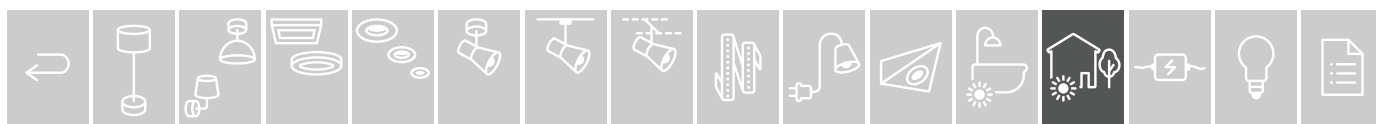



- ▶ Nostalgic look based on an anthracite-coloured frame and clear glass shade
- ▶ Perfect for retro-style all-glass filament lamps
- ▶ Carcasa de color antracita y pantalla de cristal claro para un aire nostálgico
- ▶ Ideal para lámparas de filamento de vidrio de estilo retro
- ▶ La struttura color antracite e il paralume in vetro chiaro conferiscono un look nostalgico
- ▶ Ideale per le lampade a filamento completamente in vetro con stile Retro



#### Wall Luminaire

max. 60 W, E27  
230 V  
∅365 ∅160 ∇172 mm  
EAN 4000870 942826  
**942.82**

🌀 Grey 📊 Glass  
🌀 Gris 📊 Cristal  
🌀 Grigio 📊 Vetro



#### Wall Luminaire

max. 60 W, E27  
230 V  
∅540 ∅160 ∇172 mm  
EAN 4000870 942819  
**942.81**

🌀 Grey 📊 Glass  
🌀 Gris 📊 Cristal  
🌀 Grigio 📊 Vetro



#### Wall Classic

max. 15 W, E27  
230 V  
∅315 ∅173 ∇210 mm  
EAN 4000870 943984  
**943.98**

🌀 Dark grey 📊 Metal/Glass  
🌀 Gris oscuro 📊 Metal/Cristal  
🌀 Grigio scuro 📊 Metallo/Vetro



#### Wall Classic

max. 15 W, E27  
230 V  
∅327 ∅173 ∇210 mm  
EAN 4000870 943960  
**943.96**

🌀 Dark grey 📊 Metal/Glass  
🌀 Gris oscuro 📊 Metal/Cristal  
🌀 Grigio scuro 📊 Metallo/Vetro



90°  
4-8m  
On < 20Lux / Off > 20Lux  
Time ON < 5 sec - 5 min.

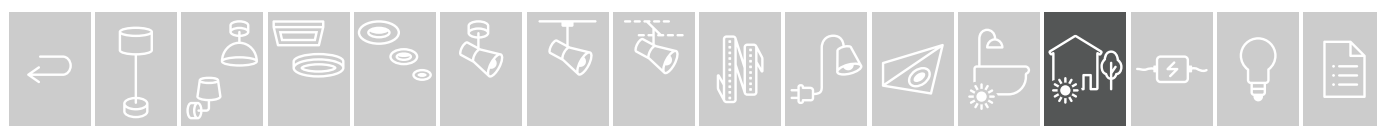



**Classic curved**

max. 12 W, E27  
230 V  
∅230 ∅180 mm  
EAN 4000870 943915

**943.91**

- 🔗 Clear/Black 🏠 Plastic
- 🔗 Transparente/Negro 🏠 Plástico
- 🔗 Trasparente/Nero 🏠 Plastica



**Classic curved**

max. 12 W, E27  
230 V  
∅225 ∅190 mm  
EAN 4000870 943922

**943.92**

- 🔗 Clear/Black 🏠 Plastic
- 🔗 Transparente/Negro 🏠 Plástico
- 🔗 Trasparente/Nero 🏠 Plastica



- ▶ The reliable 230V luminaires for lighting around the house
- ▶ Satined plastic cover for glare-free illumination
- ▶ Socket for E27 lamp

- ▶ Las eficaces luminarias de 230 V para iluminar el entorno de la casa
- ▶ Iluminación sin deslumbramiento gracias a la cubierta de plástico satinada
- ▶ Casquillo para lámparas E27

- ▶ Le affidabili lampade da 230 V per ottenere luce intorno alla casa
- ▶ Illuminazione priva di effetto abbagliante grazie alla copertura in plastica satinata
- ▶ Attacco per lampadine E27



**Tube**

max. 15 W, E27  
230 V  
∅200 ∅120 ∅175 mm  
EAN 4000870 941867

**941.86**

- 🔗 Anthracite 🏠 Plastic
- 🔗 Antracita 🏠 Plástico
- 🔗 Antracite 🏠 Plastica

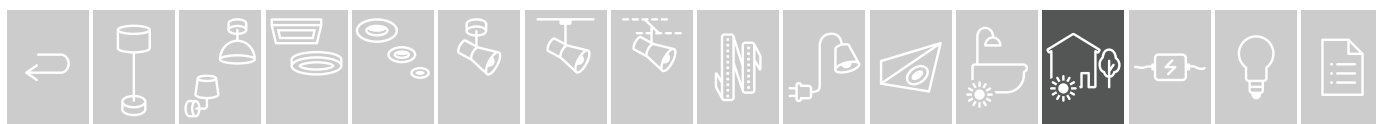



- ▶ Directed light with a 34° beam angle for outdoor illumination
- ▶ Perfect for the illumination of house entrances, canopies, roof overhangs, garages and carports
- ▶ Luz dirigida para el exterior con un ángulo de irradiación de 34°
- ▶ Ideal para la iluminación de entradas de casa, marquesinas, aleros de cubierta, garajes o carports
- ▶ Luce mirata per esterni con un angolo di irradiazione di 34°
- ▶ Ideale per l'illuminazione di ingressi di casa, pensiline, sporgenze del tetto, garage e carport



#### House Downlight

incl. 1x5,8W  
530 lm, 3.000 K  
∠ 34°  
230V  
∅3 ∅95 mm  
EAN 4000870 796665

**796.66**

- 🌀 Silver 📦 Metal/Acrylic
- 🌀 Plateado 📦 Metal/Acrílico
- 🌀 Argento 📦 Metallo/Acricolo



#### House surface mounted Downlight

incl. 1x5,8W  
530 lm, 3.000 K  
∠ 34°  
230V  
∅95 ∅95 mm  
EAN 4000870 796702

**796.70**

- 🌀 Anthracite 📦 Aluminium/Acrylic
- 🌀 Antracita 📦 Aluminio/Acrílico
- 🌀 Antracite 📦 Alluminio/Acricolo

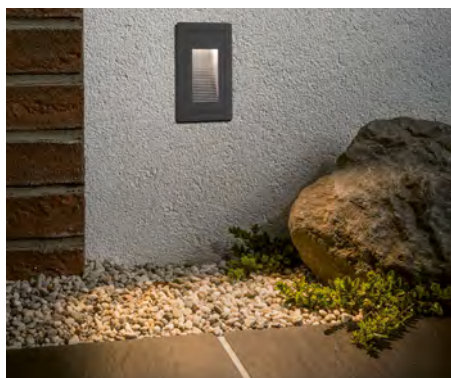

- ▶ Recessed wall luminaire for orientation lighting around the outside of the house
- ▶ Incl. mounting box for safe installation and removal for subsequent maintenance
- ▶ Apliques empotrables para la iluminación de orientación alrededor de la casa
- ▶ Incluye caja empotrable para el montaje seguro y la posibilidad de extracción en un posterior mantenimiento
- ▶ Faretto da incasso a parete per l'illuminazione di orientamento intorno alla casa
- ▶ Inclusa presa a incasso per un'installazione sicura con possibilità di rimuoverla per eventuali manutenzioni successive.



#### Wall DL high

incl. 1x4W  
500 lm, 3.000 K  
230V  
∅62 ∅103 ∅58 mm  
EAN 4000870 943823

**943.82**

- 🌀 Black 📦 Aluminium
- 🌀 Negro 📦 Aluminio
- 🌀 Nero 📦 Alluminio

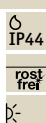

#### Wall DL long

incl. 1x4W  
500 lm, 3.000 K  
230V  
∅62 ∅103 ∅58 mm  
EAN 4000870 943830

**943.83**

- 🌀 Black 📦 Aluminium
- 🌀 Negro 📦 Aluminio
- 🌀 Nero 📦 Alluminio

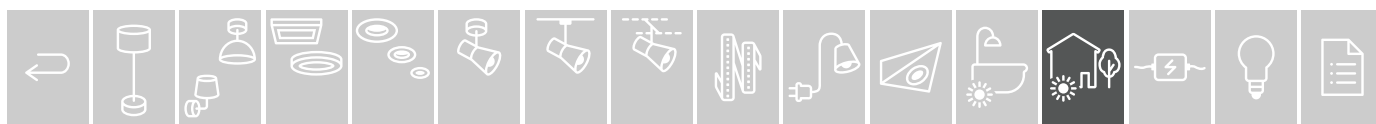
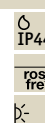

- ▶ 230-V in-ground luminaires with decorative lighting effects
- ▶ Max. load of 500 kg
- ▶ Incl. mounting box for safe installation and removal for subsequent maintenance

- ▶ Luminarias empotrables en el suelo de 230 V con efectos lumínicos decorativos
- ▶ Carga máxima 500 kg
- ▶ Incluye caja empotrable para el montaje seguro y la posibilidad de extracción en un posterior mantenimiento

- ▶ Faretti da incasso a pavimento 230 V con effetti luminosi decorativi
- ▶ Possibilità di carico pari a 500 kg
- ▶ Inclusa presa a incasso per un'installazione sicura con possibilità di rimuoverla per eventuali manutenzioni successive.

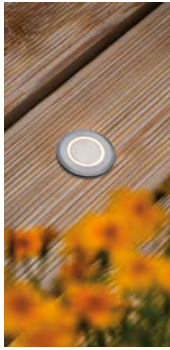

**Floor**  
 incl. 1x2 W  
 210 lm, 3.000 K  
 <math>\sphericalangle 120^\circ</math>, 230 V  
 <math>\updownarrow 82 \varnothing 50</math> mm  
 EAN 4000870 943632  
**943.63**  
 & Acero inoxidable cepillado  
 & Metal  
 & Acero inoxidable cepillado  
 & Metal  
 & Acciaio legato spazzolato  
 & Metal

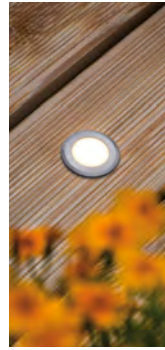

**Floor**  
 incl. 1x2 W  
 210 lm, 3.000 K  
 <math>\sphericalangle 120^\circ</math>, 230 V  
 <math>\updownarrow 82 \varnothing 50</math> mm  
 EAN 4000870 943656  
**943.65**  
 & Acero inoxidable cepillado  
 & Metal  
 & Acero inoxidable cepillado  
 & Metal  
 & Acciaio legato spazzolato  
 & Metal

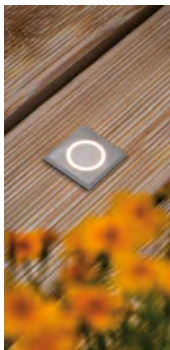

**Floor**  
 incl. 1x2 W  
 210 lm, 3.000 K  
 <math>\sphericalangle 120^\circ</math>, 230 V  
 <math>\updownarrow 82 \leftrightarrow 50 \varnothing 50</math> mm  
 EAN 4000870 943649  
**943.64**  
 & Acero inoxidable cepillado  
 & Metal  
 & Acero inoxidable cepillado  
 & Metal  
 & Acciaio legato spazzolato  
 & Metal

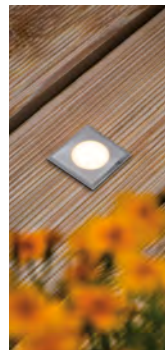

**Floor**  
 incl. 1x2 W  
 210 lm, 3.000 K  
 <math>\sphericalangle 120^\circ</math>, 230 V  
 <math>\updownarrow 82 \leftrightarrow 50 \varnothing 50</math> mm  
 EAN 4000870 943663  
**943.66**  
 & Acero inoxidable cepillado  
 & Metal  
 & Acero inoxidable cepillado  
 & Metal  
 & Acciaio legato spazzolato  
 & Metal



- ▶ Dust- and waterproof during temporary immersion (IP67)
- ▶ Operates directly with 230 V

- ▶ Hermético al polvo y resistente al agua en caso de inmersión temporánea (IP67)
- ▶ Funciona directamente con 230 V

- ▶ Protezione da penetrazione di polvere e breve immersione in acqua (IP67)
- ▶ Funzionamento diretto a 230 V



**Floor LED**  
 incl. 1x3,5 W, GU10  
 230 lm, 3.000 K  
 230 V  
 <math>\updownarrow 124 \varnothing 108</math> mm  
 EAN 4000870 939925  
**939.92**  
 & Metal  
 & Metal  
 & Metal



**Floor LED**  
 incl. 1x3,5 W, GU10  
 230 lm, 3.000 K  
 230 V  
 <math>\updownarrow 124 \leftrightarrow 108 \varnothing 108</math> mm  
 EAN 4000870 939932  
**939.93**  
 & Metal  
 & Metal  
 & Metal





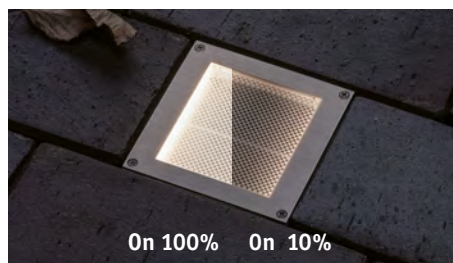

Sensor

360°

1m

On 100% Time &lt;30 sec / On 10%

- ▶ In-ground Brick luminaire with motion sensor
- ▶ Max. load of 500 kg
- ▶ Standard brick size 10 x 10 or 10 x 20 cm

- ▶ Luminarias empotrables en el suelo Brick con detector de movimientos
- ▶ Carga máxima 500 kg
- ▶ Medida estándar de la piedra de 10 x 10 o 10 x 20 cm

- ▶ Faretto da incasso a pavimento Brick incl. rilevatore di movimento
- ▶ Possibilità di carico pari a 500 kg
- ▶ Pietra standard misura 10 x 10 o 10 x 20 cm

**Brick**

incl. 1x0,8W  
80 lm, 3.000 K  
230 V  
⌀42 ⇔100 ⌀100 mm  
EAN 4000870 943366

Kg  
500**943.36**

- 🔗 Aluminium/Grey 🗪 Metal/Stainless steel
- 🔗 Aluminio/Gris 🗪 Metal/Acero inoxidable
- 🔗 Alluminio/Grigio 🗪 Metallo/Acciaio legato

**Brick**

incl. 1x1,6W  
160 lm, 3.000 K  
230 V  
⌀42 ⇔200 ⌀100 mm  
EAN 4000870 943373

Kg  
500**943.37**

- 🔗 Aluminium/Grey 🗪 Metal/Stainless steel
- 🔗 Aluminio/Gris 🗪 Metal/Acero inoxidable
- 🔗 Alluminio/Grigio 🗪 Metallo/Acciaio legato

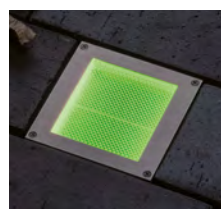
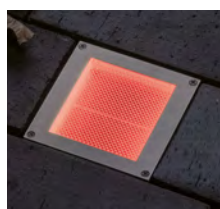

- ▶ Smart in-ground Brick luminaire for safety and orientation on all paths or for spectacular lighting effects around the house in RGB and tunable white
- ▶ Smart control via app, voice or remote control
- ▶ Stepless light colour control via ZigBee remote control, app or voice control
- ▶ Max. load of 500 kg
- ▶ Standard brick size 10 x 10 cm

- ▶ Luminaria inteligente empotrable en el suelo Brick para la seguridad y la orientación en todos los caminos o para crear efectos lumínicos espectaculares alrededor de la casa en RGB y blanco ajustable
- ▶ Posibilidad de control inteligente mediante aplicación, por voz o con control remoto
- ▶ Control continuo de la tonalidad de la luz con mando a distancia ZigBee, aplicación o voz
- ▶ Carga máxima 500 kg
- ▶ Medida estándar de la piedra de 10 x 10 cm

- ▶ Faretto da incasso a pavimento Smart Brick per la sicurezza e l'orientamento lungo tutti i vialetti o per ottenere spettacolari effetti luminosi intorno alla casa con colori RGB e tunable white
- ▶ Possibilità di comando Smart tramite app, comando vocale o telecomando
- ▶ Comando dei colori a regolazione illimitata tramite telecomando Zigbee, app o sistema vocale
- ▶ Possibilità di carico pari a 500 kg
- ▶ Pietra standard misura 10 x 10 cm

**Brick**

incl. 1x1W  
80 lm, 3.000 K  
230 V  
⌀42 mm  
EAN 4000870 945049  
**945.04 new**

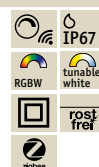

- 🔗 White 🗪 Plastic
- 🔗 Blanco 🗪 Plástico
- 🔗 Bianco 🗪 Plastica

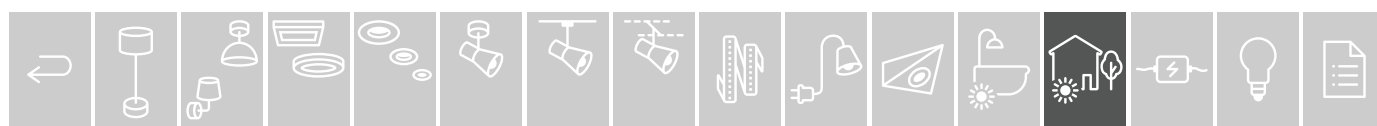



- ▶ Included diffuser allows optional accentuated or diffused light
- ▶ Operates directly with 230 V
- ▶ El difusor adjunto permite acentuar o difuminar la luz
- ▶ Funciona directamente con 230 V
- ▶ Possibilità di scelta tra luce accentuata e diffusa grazie al diffusore in dotazione
- ▶ Funzionamento diretto a 230 V



**Floor LED**

incl. 1x1,2 W  
 30 lm, 2.700 K  
 <math>\sphericalangle</math> 120°, 17 cd  
 230 V  
 <math>\updownarrow</math> 132 <math>\varnothing</math> 110 mm  
 EAN 4000870 937884  
**937.88**

- 🔩 Stainless steel 📦 Metal
- 🔩 Acero inoxidable 📦 Metal
- 🔩 Acciaio legato 📦 Metallo

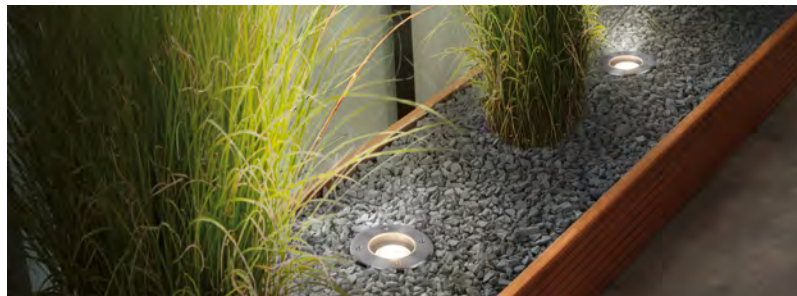

- ▶ GU10 fitting without lamp: freely selectable beam angle and light colour of the LED lamp
- ▶ Incl. mounting box for safe installation and removal for subsequent maintenance
- ▶ Max. load of 500 kg
- ▶ Con casquillo GU10 sin equipar: ángulo de irradiación y tonalidad de la luz de la lámpara LED intercambiables y de libre elección
- ▶ Incluye caja empotrable para el montaje seguro y la posibilidad de extracción en un posterior mantenimiento
- ▶ Carga máxima 500 kg
- ▶ Con attacco GU10 senza lampadina: possibilità di regolare liberamente e sostituire l'angolo di emissione e il colore della luce della lampadina LED
- ▶ Inclusa presa a incasso per un'installazione sicura con possibilità di rimuoverla per eventuali manutenzioni successive.
- ▶ Possibilità di carico pari a 500 kg



**Floor**

max. 10 W, GU10  
 230 V  
 <math>\updownarrow</math> 130 <math>\varnothing</math> 110 mm  
 EAN 4000870 943908  
**943.90**

- 🔩 Stainless steel 📦 Stainless steel
- 🔩 Acero inoxidable 📦 Acero inoxidable
- 🔩 Acciaio legato 📦 Acciaio legato

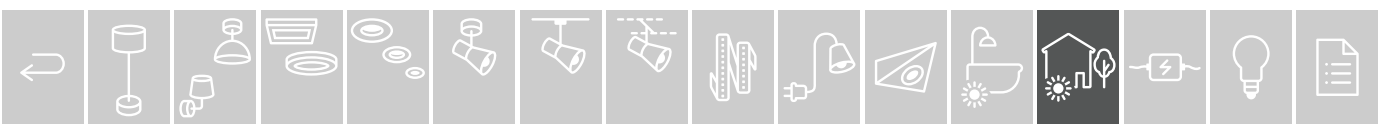
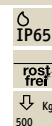



- ▶ Flexible, plug-in 230-V Flarea bollard for paths, squares and flower bed borders
- ▶ Ground spike for easy installation in soft ground
- ▶ Balizas de 230 V Flarea, flexibles y listas para conectar, para la iluminación de caminos, plazas o delimitaciones de parterres
- ▶ Estaca para la fijación sencilla en suelos blandos
- ▶ Paletto Flarea da 230 V flessibile e pronto da collegare per l'illuminazione di vialetti, punti specifici o aiuole
- ▶ Picchetto per un fissaggio semplice in terreni morbidi

**Flarea 200**

incl. 1×3,1 W  
360 lm, 3.000 K  
230 V  
∅200 ∅45 mm  
EAN 4000870 943847

**943.84**

🔗 Black 🇮🇹 Aluminium  
🔗 Negro 🇮🇹 Aluminio  
🔗 Nero 🇮🇹 Alluminio

**Flarea 400**

incl. 1×3,1 W  
360 lm, 3.000 K  
230 V  
∅400 ∅45 mm  
EAN 4000870 943854

**943.85**

🔗 Black 🇮🇹 Aluminium  
🔗 Negro 🇮🇹 Aluminio  
🔗 Nero 🇮🇹 Alluminio

**Flarea 600**

incl. 1×3,1 W  
360 lm, 3.000 K  
230 V  
∅600 ∅45 mm  
EAN 4000870 943861

**943.86**

🔗 Black 🇮🇹 Aluminium  
🔗 Negro 🇮🇹 Aluminio  
🔗 Nero 🇮🇹 Alluminio

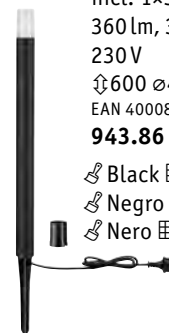

- ▶ Attractive path luminaire for driveways – goes great with the Capea wall luminaire
- ▶ Atractiva luminaria para caminos para accesos, compatible con los apliques Capea
- ▶ Accattivante apparecchio per viale d'accesso - adatto per le applique Capea

**Capea**

incl. 1×6 W  
600 lm, 3.000 K  
∠ 98°  
230 V  
∅500 ∅130 ∅172 mm  
EAN 4000870 944547

**944.54 new**

🔗 Grey 🇮🇹 Aluminium  
🔗 Gris 🇮🇹 Aluminio  
🔗 Grigio 🇮🇹 Alluminio

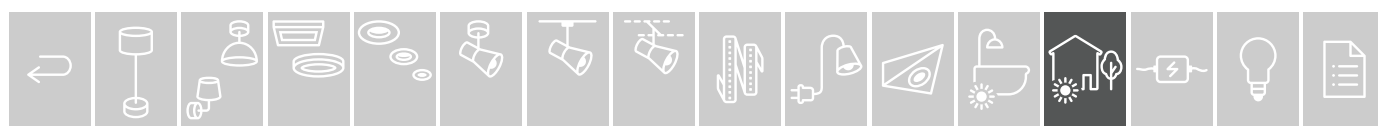



### Classic curved

max. 12 W, E27  
230 V

⌀280 ⇄164 mm  
EAN 4000870 943939

**943.93**

- 🔗 Clear/Black 📦 Plastic
- 🔗 Transparente/Negro 📦 Plástico
- 🔗 Trasparente/Nero 📦 Plastica



- ▶ Classic bollard light
- ▶ Perfect for retro-style all-glass filament lamps
- ▶ Baliza clásica
- ▶ Ideal para lámparas de filamento de vidrio de estilo retro
- ▶ Paletto d'illuminazione classico
- ▶ Ideale per le lampade a filamento completamente in vetro con stile Retro



### Bollard Classic

max. 15 W, E27  
230 V

⌀500 ø173 mm  
EAN 4000870 7

**943.97**

- 🔗 Dark grey 📦 Metal/Glass
- 🔗 Gris oscuro 📦 Metal/Cristal
- 🔗 Grigio scuro 📦 Metallo/Vetro

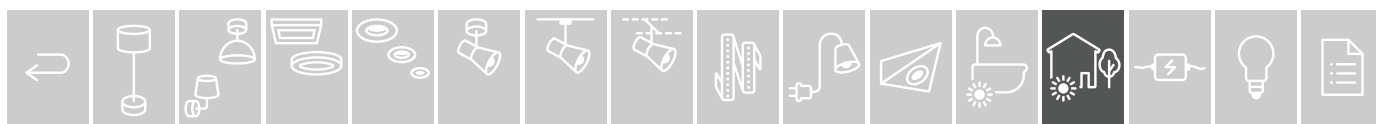



- ▶ GU10 fitting without lamp: freely selectable beam angle and light colour of the LED lamp
- ▶ Con casquillo GU10 sin equipar: ángulo de irradiación y tonalidad de la luz de la lámpara LED intercambiables y de libre elección
- ▶ Con attacco GU10 senza lampadina: possibilità di regolare liberamente e sostituire l'angolo di emissione e il colore della luce della lampadina LED

**Garden Spot**

max. 28 W, GU10  
230 V  
∅320 ∅98 ⇄100 mm  
EAN 4000870 937518  
**937.51**

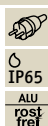

🔗 Aluminium 📦 Aluminium  
🔗 Aluminio 📦 Aluminio  
🔗 Alluminio 📦 Alluminio



- ▶ Suitable GU10 lamp included
- ▶ Can also be used without spike and as surface-mounted spotlight for façades, garden sheds and patios
- ▶ Con lámpara GU10 compatible
- ▶ También se puede usar sin estaca, a modo de proyector de superficie para iluminar fachadas, glorietas y terrazas
- ▶ Inclusa lampadina GU10 adatta
- ▶ Utilizzabile anche senza picchetto come faretto da superficie per l'illuminazione di facciate, cassette in giardino e terrazze.

**Garden Spot**

incl. 1×3,5 W, GU10  
230 lm, 3.000 K  
230 V  
∅320 ∅92 mm  
EAN 4000870 988961  
**988.96**



🔗 Black 📦 Aluminium  
🔗 Negro 📦 Aluminio  
🔗 Nero 📦 Alluminio

**Garden Spot**

incl. 3×3,5 W, GU10  
3×230 lm, 3.000 K  
230 V  
∅320 ∅92 mm  
EAN 4000870 988978  
**988.97**

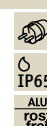

🔗 Black 📦 Aluminium  
🔗 Negro 📦 Aluminio  
🔗 Nero 📦 Alluminio

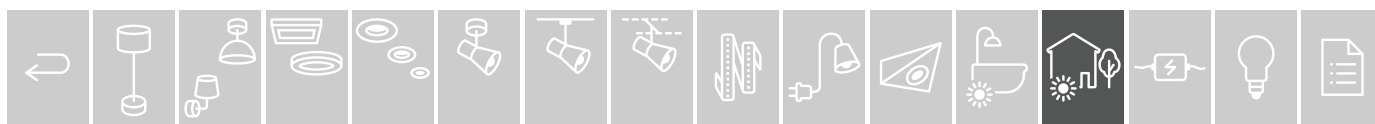



- ▶ Connection box for up to 4 lines
- ▶ Unused outputs remain closed
- ▶ Dust- and waterproof during temporary immersion (IP67)

- ▶ Caja de conexión para 4 cables
- ▶ Las tomas que no se usan permanecen cerradas
- ▶ Hermético al polvo y resistente al agua en caso de inmersión temporánea (IP67)

- ▶ Scatola di collegamento fino a 4 linee
- ▶ Le uscite inutilizzate rimangono chiuse
- ▶ Protezione da penetrazione di polvere e breve immersione in acqua (IP67)

6-12mm

**Junction-Box**

max. 2,500 W  
 ⌀140 ⇄110 ⚙55 mm  
 EAN 4000870 002322

IP67

**232**

- 🔧 Black 📦 Plastic
- 🔧 Negro 📦 Plástico
- 🔧 Nero 📦 Plastica



- ▶ Connection box for up to 3 lines
- ▶ Unused outputs remain closed
- ▶ Dust- and waterproof during permanent immersion (IP68)

- ▶ Caja de conexión para 3 cables
- ▶ Las tomas que no se usan permanecen cerradas
- ▶ Hermético al polvo y resistente al agua en caso de inmersión permanente (IP68)

- ▶ Scatola di collegamento fino a 3 linee
- ▶ Le uscite inutilizzate rimangono chiuse
- ▶ Protezione da penetrazione di polvere e immersione permanente in acqua (IP68)

12-15mm

**Junction-Box**

max. 2,500 W  
 ⌀134 ⇄105 ⚙53 mm  
 EAN 4000870 002377

IP68

**237**

- 🔧 Black 📦 Plastic
- 🔧 Negro 📦 Plástico
- 🔧 Nero 📦 Plastica

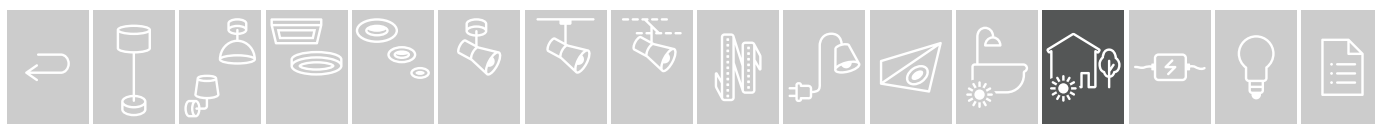



## Solar – Solar-powered luminaires for outdoor use; no power connection required

The clever Solar range includes functional lighting around the house and on the driveway.

The intelligent combination of the size of the Solar module and purpose-specific lumen output ensures sufficient luminosity all year round.

The Solar luminaires offer functional lighting with a unique design and practical additional functions like night light, house number luminaire and motion sensor light. The luminaires emit a pleasant, warm white light of 3000 K. A large part of the range comes with replaceable lithium-ion batteries. These luminaires have a 5-year warranty.

## Solar – Luminarias solares para el exterior, independientes de las tomas de corriente

El surtido inteligente Solar abarca la iluminación funcional alrededor de la casa y los accesos.

La combinación inteligente del tamaño del módulo solar y del flujo luminoso permite conseguir una intensidad y duración de la iluminación suficiente en todas las estaciones del año.

Las luminarias solares proporcionan una iluminación funcional con un diseño exclusivo y, en parte, funciones adicionales interesantes, como luz de noche, iluminación del número de casa y sensores de movimiento. Las luminarias irradian una agradable luz blanca cálida de 3000 K. Una gran parte del surtido está equipada con baterías de iones de litio reemplazables. Estas luminarias tienen 5 años de garantía.

## Solar - Apparecchi a energia solare per esterno, indipendenti dall'allacciamento alla corrente

L'intelligente gamma Solar include apparecchi funzionali per fare luce attorno alla casa e nel viale d'accesso.

La combinazione smart di dimensioni del modulo solare e del flusso luminoso in base alle esigenze garantisce un'adeguata luminosità e durata in ogni stagione dell'anno.

Le lampade solari assicurano un'illuminazione funzionale con un design unico nel suo genere e funzioni supplementari suggestive come luce notturna, illuminazione del numero civico e sensori di movimento. Le lampade emettono una luce bianca e calda con 3000K. Una grande parte della gamma di prodotti è dotata di batterie sostituibili agli ioni di litio. Per queste lampade la garanzia è di 5 anni."

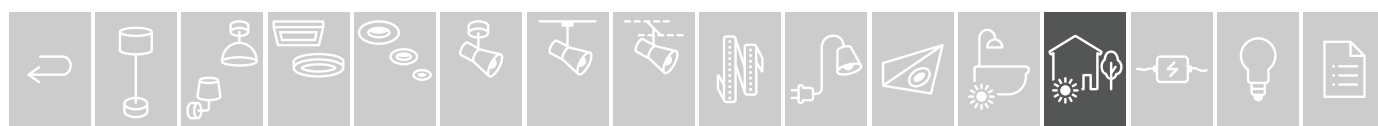



120°  
2m  
Time ON 15 sec.

► Very bright solar wall luminaires with diffused light for uniform light distribution and glare-free illumination

► Apliques solares muy potentes con luz difusa para una distribución lumínica uniforme y sin deslumbramiento

► Applique solare ad alta intensità luminosa e con luce diffusa, per una distribuzione della luce omogenea e un'illuminazione priva di effetto abbagliante



**Solar Solveig**

incl. 1x4,8W  
350lm, 3.000 K  
4x18650 Akku/3,7V  
⌀29 ↔105 ↗173 mm  
EAN 4000870 953938

**953.93 new**

- 🔧 Black 📦 Plastic
- 🔧 Negro 📦 Plástico
- 🔧 Nero 📦 Plastica

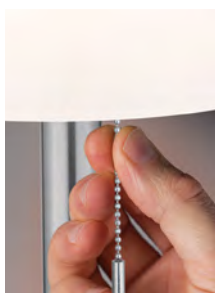
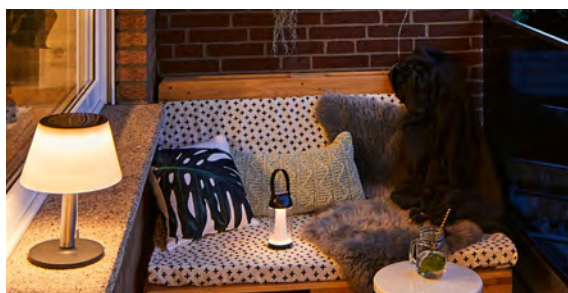

► Attractive Lillesol solar table luminaire  
► With cord switch for 3 dimming levels

► Atractiva luminaria de sobremesa solar Lillesol  
► Regulable en 3 niveles con interruptor de cable

► Accattivante lampada da tavolo solare Lillesol  
► Dimmerabile in 3 livelli con interruttore a strappo



**Solar Lillesol**

incl. 1x0,8W  
75lm, 3.000 K  
1x18650 Akku/3,7V  
⌀280 mm  
EAN 4000870 943090

**943.09**

- 🔧 Stainless steel 📦 Plastic/Metal
- 🔧 Acero inoxidable 📦 Plástico/Metal
- 🔧 Acciaio legato 📦 Plastica/Metallo

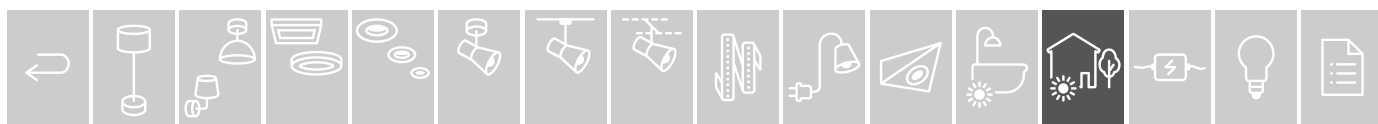





180°  
8m  
Time ON 30 sec.

► High lumen output from solar energy

► Rendimiento lumínico elevado a partir de energía solar

► Elevate prestazioni in termini di Lumen da energia solare



#### Solar Kiran

incl. 1x5 W  
600 lm, 3.000 K  
⌀69 ⇄350 ⌀186 mm  
EAN 4000870 943380

**943.38 new**

🔧 White 📦 Plastic  
🔧 Blanco 📦 Plástico  
🔧 Bianco 📦 Plastica



#### Solar Kiran

incl. 1x3 W  
400 lm, 3.000 K  
⌀65 ⇄300 ⌀168 mm  
EAN 4000870 943410

**943.41 new**

🔧 White 📦 Plastic  
🔧 Blanco 📦 Plástico  
🔧 Bianco 📦 Plastica



180°  
8m  
Time ON 30 sec.

► High lumen output from solar energy

► Rendimiento lumínico elevado a partir de energía solar

► Elevate prestazioni in termini di Lumen da energia solare



#### Solar Kiran

incl. 1x5 W  
600 lm, 3.000 K  
⌀69 ⇄350 ⌀186 mm  
EAN 4000870 943397

**943.39 new**

🔧 Anthracite 📦 Plastic  
🔧 Antracita 📦 Plástico  
🔧 Antracite 📦 Plastica



#### Solar Kiran

incl. 1x3 W  
400 lm, 3.000 K  
⌀65 ⇄300 ⌀168 mm  
EAN 4000870 943403

**943.40 new**

🔧 Anthracite 📦 Plastic  
🔧 Antracita 📦 Plástico  
🔧 Antracite 📦 Plastica





- ▶ The highlight: a 350°-rotatable solar panel allows perfect alignment for optimal solar energy absorption.
- ▶ Incl. lithium-ion battery, dusk sensor, nightlight function and motion sensor.
- ▶ Charging time: 8h, working light 150lm: 1.5h, orientation light 10lm: 15h

- ▶ Lo mejor: el panel solar se puede girar en 350°, permitiendo la orientación ideal para la absorción óptima de la energía solar.
- ▶ Incluye batería de iones de litio, sensor crepuscular, función de luz de noche y detector de movimientos.
- ▶ Tiempo de carga: 8 h, luz de trabajo 150 lm: 1,5 h, luz de orientación 10 lm: 15 h

- ▶ Il clou: il pannello solare rotante a 350° consente un orientamento ideale per l'assorbimento ottimale dell'energia solare.
- ▶ Include batteria agli ioni di litio, sensore crepuscolare, funzione luce notturna e sensore di movimento.
- ▶ Tempo di carica: 8h, luce di lavoro 150lm: 1,5h, luce di orientamento 10lm: 15h

**Solar Ilias**

incl. 1x1,2W  
115 lm, 3.000 K  
1x18650 Akku/3,7V  
∅261 ⇄73 ⇄175 mm  
EAN 4000870 942604

**942.60**

- 🌀 Anthracite 🏠 Plastic
- 🌀 Antracita 🏠 Plástico
- 🌀 Antracite 🏠 Plastica

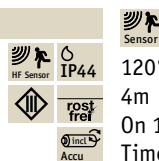

**Sensor**  
120°  
4m  
On 100% 10 sec.  
Time ON 10%.

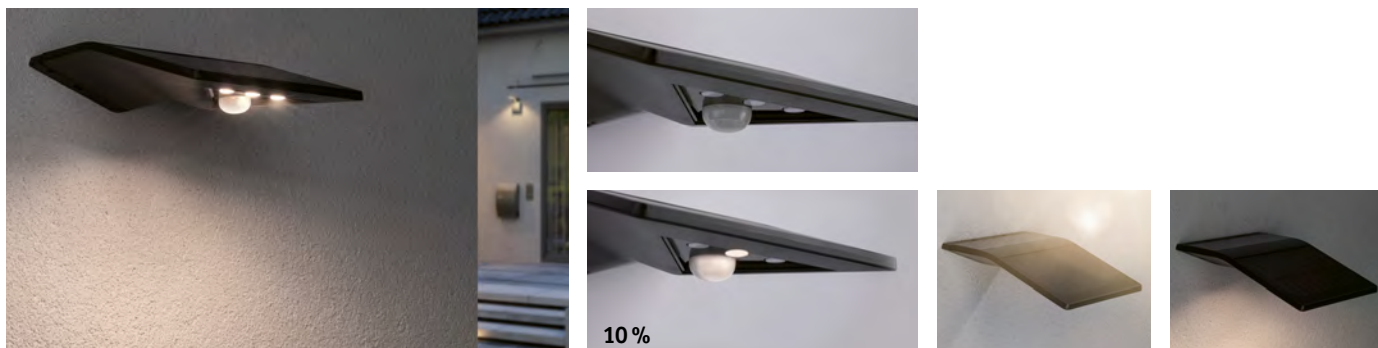
**Solar Yoko**

incl. 1x1,2W  
145 lm, 3.000 K  
1x18650 Akku/3,7V  
∅57 ⇄160 ⇄190 mm  
EAN 4000870 942451

**942.45**

- 🌀 Anthracite 🏠 Plastic
- 🌀 Antracita 🏠 Plástico
- 🌀 Antracite 🏠 Plastica



**Sensor**  
120°  
3m  
On 100% 10 sec.  
Time ON 10%.

**Solar Yoko Zigbee**

incl. 1x1W  
115 lm, 3.000 K  
1x18650 Akku/3,7V  
∅57 ⇄160 ⇄190 mm  
EAN 4000870 942789

**942.78**

- 🌀 Anthracite 🏠 Plastic
- 🌀 Antracita 🏠 Plástico
- 🌀 Antracite 🏠 Plastica



smart  
controllable  
**zigbee**

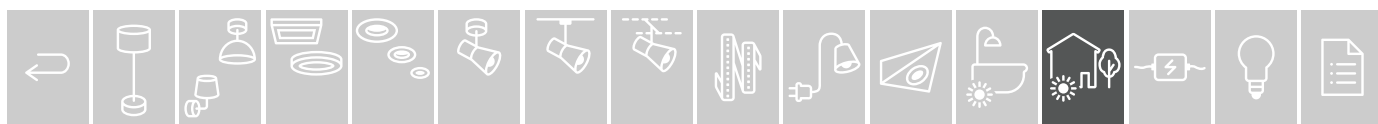

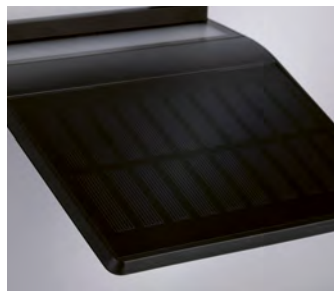

0123456789  
0123456789  
abcd

- ▶ Incl. lithium-ion battery, dusk sensor, nightlight function and motion sensor.
  - ▶ Charging time: 8h, working light 150lm: 1.5h, orientation light 10lm: 15h
  - ▶ Self-adhesive number and letter sets included.
- ▶ Incluye batería de iones de litio, sensor crepuscular, función de luz de noche y detector de movimientos.
  - ▶ Tiempo de carga: 8 h, luz de trabajo 150 lm: 1,5 h, luz de orientación 10 lm: 15 h
  - ▶ Incluye un juego de cifras y letras autoadhesivas.
- ▶ Include batteria agli ioni di litio, sensore crepuscolare, funzione luce notturna e sensore di movimento.
  - ▶ Tempo di carica: 8h, luce di lavoro 150lm: 1,5h, luce di orientamento 10lm: 15h
  - ▶ Set di numeri e lettere autoadesivi compresi.



#### Solar Yoko

incl. 1x1,2W  
145 lm, 3.000 K  
1x18650 Akku/3,7V  
⌀175 ⇄160 ⌀190 mm  
EAN 4000870 942437

**942.43**

- 🌀 Anthracite 🗪 Plastic
- 🌀 Antracita 🗪 Plástico
- 🌀 Antracite 🗪 Plastica

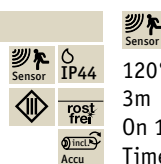

Sensor  
120°  
3m  
On 100% 10sec.  
Time ON 10%.

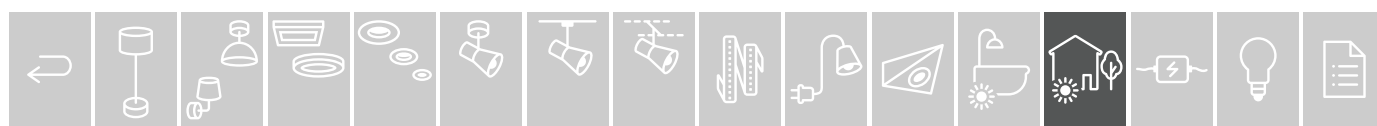



- Incl. lithium-ion battery, dusk sensor, nightlight function and motion sensor.
- Charging time: 8h, working light 150lm: 1.5h, orientation light 10lm: 15h

- Incluye batería de iones de litio, sensor crepuscular, función de luz de noche y detector de movimientos.
- Tiempo de carga: 8 h, luz de trabajo 150 lm: 1,5 h, luz de orientación 10 lm: 15 h

- Include batteria agli ioni di litio, sensore crepuscolare, funzione luce notturna e sensore di movimento.
- Tempo di carica: 8h, luce di lavoro 150lm: 1,5h, luce di orientamento 10lm: 15h

**Solar Soley**

incl. 1x1,22 W  
150 lm, 3.000 K  
1x18650 Akku/3,7V  
∅100 ⇄104 ↗240 mm  
EAN 4000870 942505



120°

3m

On 100% 10sec.  
Time ON 10%.

↳ Anthracite Plastic/Metal  
↳ Antracita Plástico/Metal  
↳ Antracite Plastica/Metallo

**Solar Soley**

incl. 1x1,22 W  
150 lm, 3.000 K  
1x18650 Akku/3,7V  
∅100 ⇄104 ↗240 mm  
EAN 4000870 942512

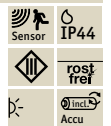

120°

3m

On 100% 10sec.  
Time ON 10%.

↳ White Plastic/Metal  
↳ Blanco Plástico/Metal  
↳ Bianco Plastica/Metallo

**Solar Soley Zigbee**

incl. 1x1 W  
115 lm, 3.000 K  
1x18650 Akku/3,7V  
∅100 ⇄104 ↗240 mm  
EAN 4000870 942796



smart  
controllable

**942.79**

↳ Anthracite Plastic/Metal  
↳ Antracita Plástico/Metal  
↳ Antracite Plastica/Metallo



- House number module for Soley wall luminaire
- Self-adhesive number and letter sets included.

- Módulo con el número de casa para applique Soley
- Incluye un juego de cifras y letras autoadhesivas.

- Modulo numeri civici per applique Soley
- Set di numeri e lettere autoadesivi compresi.

**Soley Housenumber**

∅134 ⇄120 ↗2 mm  
EAN 4000870 942536

**942.53**

↳ Transparent Plastic  
↳ Transparente Plástico  
↳ Trasparente Plastica

0123456789  
0123456789  
abcd





► Very bright solar wall luminaires with diffused light for uniform light distribution and glare-free illumination

► Apliques solares muy potentes con luz difusa para una distribución lumínica uniforme y sin deslumbramiento

► Applique solare ad alta intensità luminosa e con luce diffusa, per una distribuzione della luce omogenea e un'illuminazione priva di effetto abbagliante



### Solar Solveig

incl. 1x5 W  
600 lm, 3.000 K  
1x18650 Akku/3,7V  
⇅100 ⇄200 ↗130 mm  
EAN 4000870 945056



110°

8m

On 100%. Time ON 3%.  
Black Plastic  
Negro Plástico  
Nero Plastica



### Solar Eileen

incl. 1x5,5 W  
600 lm, 3.000 K  
1x18650 Akku/3,7V  
⇅65 ⇄175 ↗198 mm  
EAN 4000870 945704



110°

8m

On 100%. Time ON 3%.  
Black Plastic  
Negro Plástico  
Nero Plastica



### Solar Adya

incl. 1x2,5 W  
300 lm, 3.000 K  
1x18650 Akku/3,7V  
⇅60 ⇄180 ↗118 mm  
EAN 4000870 945711



110°

8m

On 100%. Time ON 3%.  
Black Plastic  
Negro Plástico  
Nero Plastica

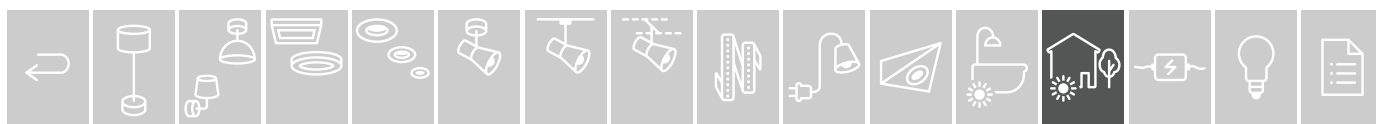









 Sensor  
120°  
2m  
Time ON 10sec.

- ▶ Incl. lithium-ion battery and motion sensor.
- ▶ Charging time: 8h, working light 150lm: 4h
- ▶ Incluye batería de iones de litio y detector de movimientos.
- ▶ Tiempo de carga: 8 h, luz de trabajo 150 lm: 4 h
- ▶ Include batteria agli ioni di litio e sensore di movimento.
- ▶ Tempo di carica: 8h, luce di lavoro 150lm: 4h

**Solar Ryse**

incl. 1x1,2W  
145 lm, 3.000 K  
1x18650 Akku/3,7V  
⌀41 ⇄154 ↗147 mm  
EAN 4000870 942468







**942.46**

-  Anthracite  Plastic
-  Antracita  Plástico
-  Antracite  Plastica

**Solar Ryse**

incl. 1x1,2W  
145 lm, 3.000 K  
1x18650 Akku/3,7V  
⌀41 ⇄154 ↗147 mm  
EAN 4000870 942475

**942.47**

-  White  Plastic
-  Blanco  Plástico
-  Bianco  Plastica









 Sensor  
120°  
4m

**Solar Eloise**

incl. 1x1W  
100 lm, 3.000 K  
1x14500/ 3,7V  
⌀220 ↗50 mm  
EAN 4000870 942642

**942.64**

-  Anthracite  Plastic
-  Antracita  Plástico
-  Antracite  Plastica





120°  
3 m  
On 100%.  
Time <3Sec.

**Solar Helena**

incl. 1x3 W  
300lm, 3.000 K  
1x18650 Akku/3,7V  
ø176 ↗62 mm  
EAN 4000870 942659

**942.65**

↳ Anthracite Plastic  
↳ Antracita Plástico  
↳ Antracite Plastica

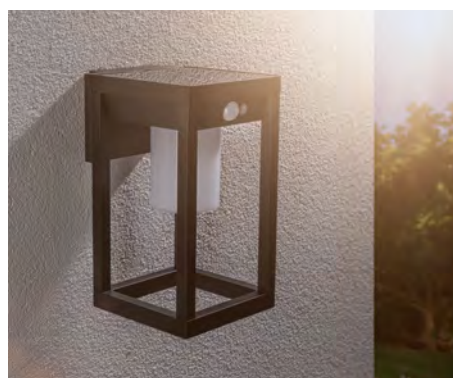

110°  
8m  
On 100%.  
Time ON 3%.

▶ LED technology with uniform, diffuse light distribution in a nostalgic lantern look

▶ Tecnología LED con distribución lumínica difusa y uniforme con una estética nostálgica de farola

▶ Tecnologia a LED con distribuzione della luce uniforme e diffusa, con un look nostalgico in stile lanterna

**Solar Marisol**

incl. 1x5,5 W  
600lm, 3.000 K  
1x18650 Akku/3,7V  
↕270 ↔150 ↗180 mm  
EAN 4000870 945728

**945.72 new**

↳ Black Plastic  
↳ Negro Plástico  
↳ Nero Plastica

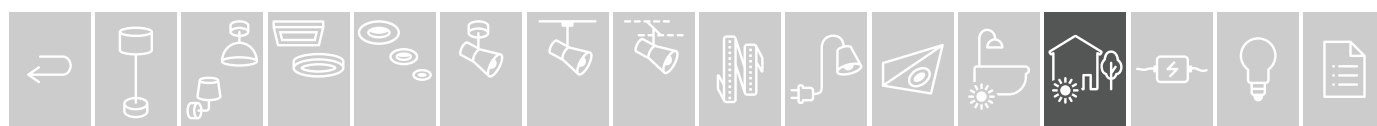

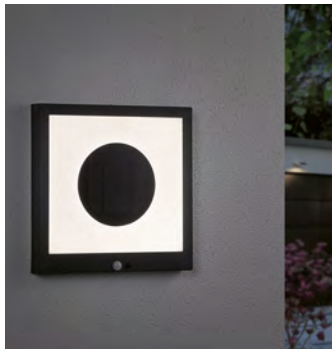

120°

4m

On &lt; 30Lux / Off &gt; 30Lux

Time ON &lt; 20 sec.

- ▶ Solar panel luminaires with motion sensor
- ▶ Luminarias de panel solares con detector de movimientos
- ▶ Lampade a pannelo solare con rilevatore di movimento
- ▶ Four different functions to choose from
- ▶ Cuatro funciones ajustables
- ▶ Quattro diverse funzioni impostabili

**Solar Taija**

incl. 1x1,2 W  
120 lm, 3.000 K  
1x18650 Akku/3,7V  
∅300 ⇄300 ∇45 mm  
EAN 4000870 942635

**942.63**

- ↳ Anthracite Metal
- ↳ Antracita Metal
- ↳ Antracite Metallo

**Solar Panel Taija**

incl. 1x2 W  
200 lm, 3.000 K  
1x18650 Akku/3,7V  
∅400 ⇄400 ∇42 mm  
EAN 4000870 943106

**943.10**

- ↳ Anthracite Metal
- ↳ Antracita Metal
- ↳ Antracite Metallo

**Solar Panel Taija**

incl. 1x1,8 W  
180 lm, 3.000 K  
1x18650 Akku/3,7V  
∅600 ⇄300 ∇42 mm  
EAN 4000870 943113

**943.11**

- ↳ Anthracite Metal
- ↳ Antracita Metal
- ↳ Antracite Metallo

0101234  
56756789  
ABCDE**Solar Dayton**

incl. 1x0,05 W  
6 lm, 3.000 K  
1xAA-Akku/1,5V (Mignon)  
4,8 V  
∅175 ⇄225 ∇63 mm  
EAN 4000870 953884

**953.88 new**

- ↳ Black Plastic
- ↳ Negro Plástico
- ↳ Nero Plastica







- ▶ 6-8 hour charge time with sun alignment, provides 4 to 6 hours of light
- ▶ Incl. dusk sensor, is turned on only after dark
- ▶ Self-adhesive number and letter sets included.
- ▶ Tiempo de carga en orientación al sol, 6-8 horas, duración luz, 4-6 horas
- ▶ Sensor crepuscular, no se enciende hasta que oscurece
- ▶ Incluye un juego de cifras y letras autoadhesivas.
- ▶ Tempo di carica alla luce solare: 6-8 ore, durata di illuminazione: 4-6 ore
- ▶ Sensore crepuscolare
- ▶ Set di numeri e lettere autoadesivi compreso.



#### Solar House Number

incl. 1x0,2 W

3.000 K

2xAA-Akku/1,5V (Mignon)

∅220 ↔230 ∅60 mm

EAN 4000870 937655

**937.65**

☞ Stainless steel/White ☐ Stainless steel/Acrylic ☞ Acero inoxidable Blanco ☐ Acero inoxidable/Acrílico ☞ Acciaio legato/Bianco ☐ Acciaio legato/Acrilico



90°

3m

On < 20Lux 10% / Off > 20Lux

Time ON < 20sec.

- ▶ House number luminaire illuminates the house number above and the façade below
- ▶ La luz para número de casa ilumina el número de casa hacia arriba y la pared de la casa hacia abajo
- ▶ Lampada per il numero civico che illumina verso l'alto il numero civico e verso il basso la parete dell'abitazione



#### Solar Neda

incl. 1x1 W

80 lm, 3.000 K

1x18650 Akku/3,7V

∅37 ↔163 ∅226 mm

EAN 4000870 945773

**945.77 new**

☞ Anthracite ☐ Plastic  
☞ Antracita ☐ Plástico  
☞ Antracite ☐ Plastica



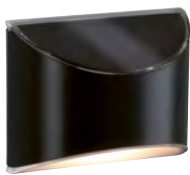

- ▶ Orientation and path luminaires
- ▶ Incl. dusk sensor, is turned on only after dark
- ▶ Charging time: 12h, operating time: 8h
- ▶ Luces de orientación y luminarias para caminos
- ▶ Sensor crepuscular, no se enciende hasta que oscurece
- ▶ Tiempo de carga: 12 h, tiempo de funcionamiento: 8 h
- ▶ Luce di orientamento e per viali
- ▶ Sensore crepuscolare
- ▶ Tempo di carica: 12h, durata: 8h

**Solar Way Elliot**

incl. 1x0,05 W  
7 lm, 3.000 K  
1xAA-Akku/1,5V (Mignon)  
∅80 ⇄100 ↗53 mm  
EAN 4000870 942338  
**942.33**

🌀 Anthracite 🗄 Plastic  
🌀 Antracita 🗄 Plástico  
🌀 Antracite 🗄 Plastica

**Solar Way Dayton**

incl. 1x0,05 W  
4 lm, 3.000 K  
1xAAA-Akku/1,5V (Micro)  
∅80 ⇄100 ↗20 mm  
EAN 4000870 942345  
**942.34**

🌀 Anthracite 🗄 Plastic  
🌀 Antracita 🗄 Plástico  
🌀 Antracite 🗄 Plastica

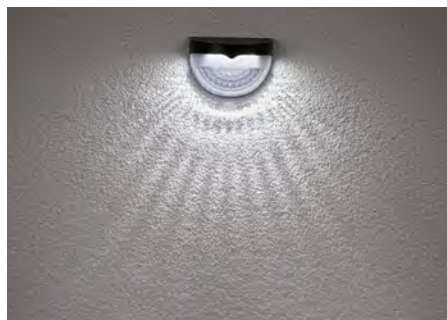
**Solar Way Mimmo**

incl. 1x1,2 W  
20 lm, 6.500 K  
∅63 ⇄90 ↗50 mm  
EAN 4000870 946664  
**946.66 new**

🌀 Black 🗄 Plastic  
🌀 Negro 🗄 Plástico  
🌀 Nero 🗄 Plastica



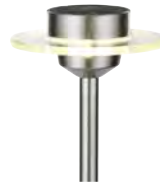
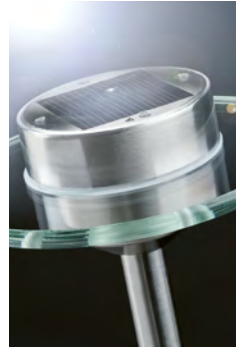

- ▶ 6-8 hour charge time with sun alignment, provides 3 to 5 hours of light
- ▶ Tiempo de carga en orientación al sol, 6-8 horas, duración luz, 3-5 horas
- ▶ Tempo di carica alla luce solare: 6-8 ore, durata di illuminazione: 3-5 ore

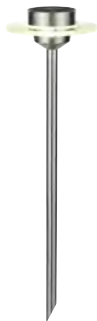

### Solar Ufo

incl. 1x0,2 W  
3.000 K  
2xAAA-Akku/1,5V (Micro)  
±550 ø150 mm  
EAN 4000870 937648

**937.64**

☞ Stainless steel/Clear ☒ Stainless steel/  
Glass  
☞ Acero inoxidable/Transparente  
☒ Acero inoxidable/Cristal  
☞ Acciaio legato/Trasparente  
☒ Acciaio legato/Vetro



Sensor  
120°  
1,5m  
On 10 sec.

- ▶ Incl. lithium-ion battery and motion sensor.
- ▶ Incluye batería de iones de litio y detector de movimientos.
- ▶ Include batteria agli ioni di litio e sensore di movimento.
- ▶ Charging time: 8h, working light 150lm: 4h
- ▶ Tiempo de carga: 8 h, luz de trabajo 150 lm: 4 h
- ▶ Tempo di carica: 8h, luce di lavoro 150lm: 4h



### Solar Ryse

incl. 1x1,2 W  
145 lm, 3.000 K  
1x18650 Akku/3,7V  
±796 ↔154 ↗194 mm  
EAN 4000870 942499

**942.49**

☞ Anthracite ☒ Plastic/Metal  
☞ Antracita ☒ Plástico/Metal  
☞ Antracite ☒ Plastica/Metallo

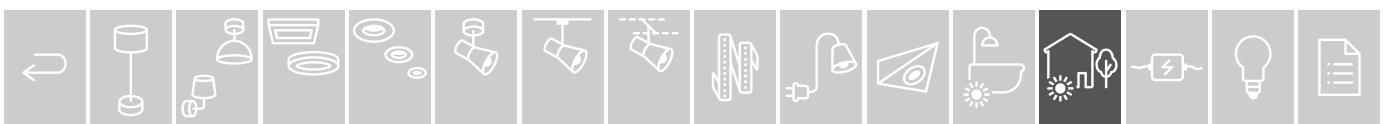



120°  
3m  
On 100% 10sec.  
Time ON 10%.

- ▶ The highlight: a 350°-rotatable solar panel allows perfect alignment for optimal solar energy absorption.
- ▶ Incl. lithium-ion battery, dusk sensor, nightlight function and motion sensor.
- ▶ Charging time: 8h, working light 150lm: 1.5h, orientation light 10lm: 15h
- ▶ Lo mejor: el panel solar se puede girar en 350°, permitiendo la orientación ideal para la absorción óptima de la energía solar.
- ▶ Incluye batería de iones de litio, sensor crepuscular, función de luz de noche y detector de movimientos.
- ▶ Tiempo de carga: 8 h, luz de trabajo 150 lm: 1,5 h, luz de orientación 10 lm: 15 h
- ▶ Il clou: il pannello solare rotante a 350° consente un orientamento ideale per l'assorbimento ottimale dell'energia solare.
- ▶ Include batteria agli ioni di litio, sensore crepuscolare, funzione luce notturna e sensore di movimento.
- ▶ Tempo di carica: 8h, luce di lavoro 150lm: 1,5h, luce di orientamento 10lm: 15h

**Solar Ilias**

incl. 1x1,2W  
115 lm, 3.000 K  
1x18650 Akku/3,7V  
∅720 ⇄73 ⇄179 mm  
EAN 4000870 942628

**942.62**

- 🔧 Anthracite 🏠 Plastic
- 🔧 Antracita 🏠 Plástico
- 🔧 Antracite 🏠 Plastica



110°  
8m  
On 100%.  
Time ON 3%.

- ▶ LED technology with uniform, diffuse light distribution in a nostalgic lantern look
- ▶ Tecnología LED con distribución lumínica difusa y uniforme con una estética nostálgica de farola
- ▶ Tecnologia a LED con distribuzione della luce uniforme e diffusa, con un look nostalgico in stile lanterna

**Solar\_Marisol**

incl. 1x5,5W  
600 lm, 3.000 K  
1x18650 Akku/3,7V  
∅400 ⇄150 ⇄150 mm  
EAN 4000870 945735

**945.73 new**

- 🔧 Black 🏠 Plastic
- 🔧 Negro 🏠 Plástico
- 🔧 Nero 🏠 Plastica

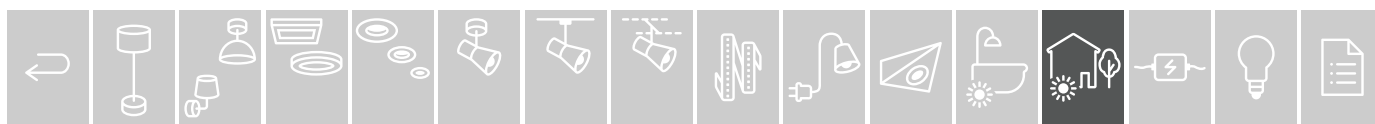



- ▶ Incl. lithium-ion battery, dusk sensor, nightlight function and motion sensor.
- ▶ Charging time: 8h, working light 150lm: 1.5h, orientation light 10lm: 15h
- ▶ Incluye batería de iones de litio, sensor crepuscular, función de luz de noche y detector de movimientos.
- ▶ Tiempo de carga: 8 h, luz de trabajo 150 lm: 1,5 h, luz de orientación 10 lm: 15 h
- ▶ Include batteria agli ioni di litio, sensore crepuscolare, funzione luce notturna e sensore di movimento.
- ▶ Tempo di carica: 8h, luce di lavoro 150lm: 1,5h, luce di orientamento 10lm: 15h



### Solar Soley

incl. 1x1,22 W  
150 lm, 3.000 K  
1x18650 Akku/3,7V  
∅848 ⇄100 ↗128 mm  
EAN 4000870 942529

**942.52**

↳ Anthracite Plastic/Metal  
↳ Antracita Plástico/Metal  
↳ Antracite Plastica/Metallo



120°  
3m  
On 100% 10 sec.  
Time ON 10%.



### Solar Soley Zigbee

incl. 1x1 W  
115 lm, 3.000 K  
1x18650 Akku/3,7V  
∅848 ⇄100 ↗128 mm  
EAN 4000870 942802

**942.80**

↳ Anthracite Plastic/Metal  
↳ Antracita Plástico/Metal  
↳ Antracite Plastica/Metallo



smart  
controllable  
 **zigbee**

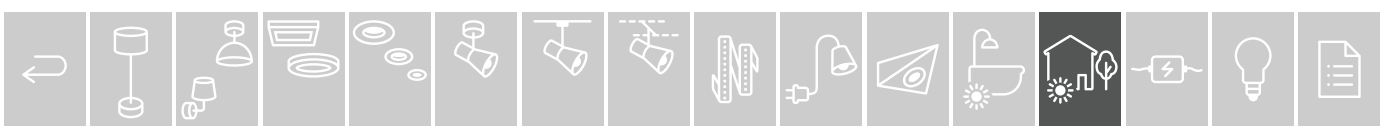

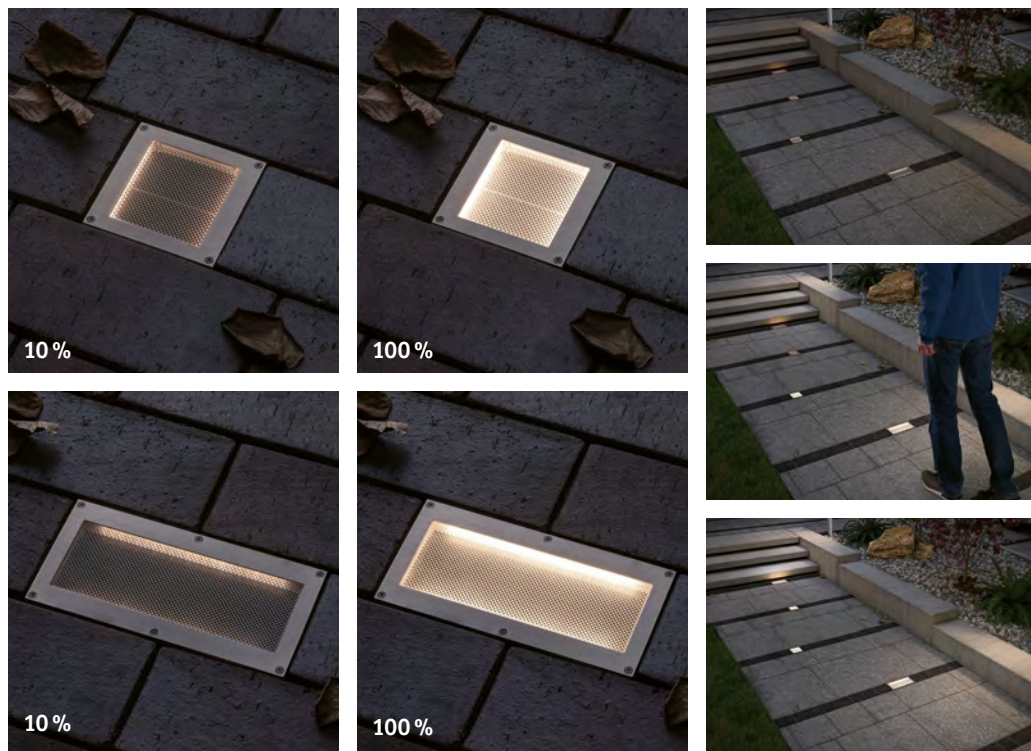

360°  
1m  
On 100% 10sec.  
Time ON 10%.

- ▶ Recessed floor luminaire with orientation light and motion sensor
  - ▶ Thanks to its IP67 rating, the recessed floor luminaire is waterproof, rustproof and can withstand loads of up to 500 kg - making it suitable for installation in outdoor pedestrian areas.
  - ▶ Clever additional functions: motion sensor, dusk sensor and orientation light function
  - ▶ Charging time: 8h, working light 50lm / 160lm: >1h, orientation light 5lm: 12h
- ▶ Luminaria empotrable en el suelo con luz de orientación y detector de movimientos
  - ▶ Gracias al grado de protección IP67, la luminaria empotrable en el suelo es totalmente estanca al agua, inoxidable y apropiada para el montaje empotrado en zonas exteriores transitables, soporta una carga de hasta 500 kg.
  - ▶ Elementos prácticos con funciones adicionales inteligentes: detector de movimientos, sensor crepuscular y función de luz de orientación
  - ▶ Tiempo de carga: 8 h, luz de trabajo 50 lm / 160 lm: >1h, luz de orientación 5 lm: 12 h
- ▶ FI da pavimento con illuminazione di orientamento e rilevatore di movimento
  - ▶ Il faretto da incasso a pavimento è garantito come impermeabile grazie al tipo di protezione IP67, oltre a essere anti-ruggine e idoneo per l'incasso in ambienti esterni calpestabili. Caricabile fino a 500kg.
  - ▶ Un pratico aiutante grazie alle funzioni aggiuntive intelligenti: rilevatore di movimento, sensore crepuscolare e funzione luce di orientamento
  - ▶ Tempo di carica: 8h, luce di lavoro 50lm / 160lm: >1h, luce di orientamento 5lm: 12h

**Solar Aron**

incl. 1x0,7W  
50lm, 3.000K  
1x18650 Akku/3,7V  
∅42 ⇄100 ∅100mm  
EAN 4000870 942383  
**942.38**



- 🔌 White 🧱 Stainless steel/Plastic
- 🔌 Blanco 🧱 Acero inoxidable/Plástico
- 🔌 Bianco 🧱 Acciaio legato/Plastica

**Solar Aron**

incl. 1x1,5W  
160lm, 3.000K  
1x18650 Akku/3,7V  
∅42 ⇄200 ∅100mm  
EAN 4000870 942390  
**942.39**



- 🔌 White 🧱 Stainless steel/Plastic
- 🔌 Blanco 🧱 Acero inoxidable/Plástico
- 🔌 Bianco 🧱 Acciaio legato/Plastica

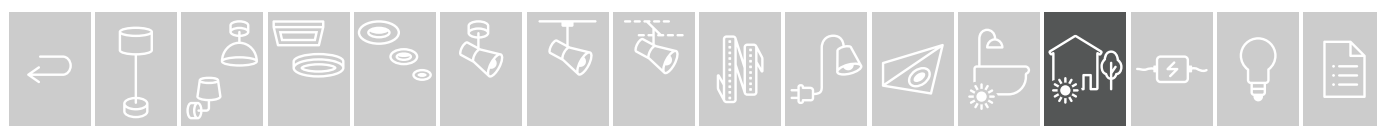



- ▶ Charging time: 8h, orientation light 10lm: 8-10h
- ▶ Thanks to its IP67 rating, the recessed floor luminaire is waterproof, rustproof and can withstand loads of up to 500 kg - making it suitable for installation in outdoor pedestrian areas.
- ▶ Incl. dusk sensor, is turned on only after dark
- ▶ Tiempo de carga: 8 h, luz de orientación 10 lm: 8-10 h
- ▶ Gracias al grado de protección IP67, la luminaria empotrable en el suelo es totalmente estanca al agua, inoxidable y apropiada para el montaje empotrado en zonas exteriores transitables, soporta una carga de hasta 500 kg.
- ▶ Sensor crepuscular, no se enciende hasta que oscurece
- ▶ Tempo di carica: 8h, luce di orientamento 10lm: 8-10h
- ▶ Il faretto da incasso a pavimento è garantito come impermeabile grazie al tipo di protezione IP67, oltre a essere anti-ruggine e idoneo per l'incasso in ambienti esterni calpestabili. Caricabile fino a 500kg.
- ▶ Sensore crepuscolare



#### Solar Cube LED

incl. 1x0,24 W  
3.6 lm, 2.700 K  
1xAA-Akku/1,5V (Mignon)  
∅45 ⇔100 ∅100 mm  
EAN 4000870 937747

**937.74**

- ☞ Stainless steel/Clear ☒ Stainless steel/Polycarbonate
- ☞ Acero inoxidable/Transparente ☒ Acero inoxidable/Polycarbonato
- ☞ Acciaio legato/Trasparente ☒ Acciaio legato/Polycarbonato



#### Solar Box LED

incl. 1x0,6 W  
7.5 lm, 2.700 K  
2xAA-Akku/1,5V (Mignon)  
∅51 ⇔200 ∅100 mm  
EAN 4000870 937754

**937.75**

- ☞ Stainless steel/Clear ☒ Stainless steel/Polycarbonate
- ☞ Acero inoxidable/Transparente ☒ Acero inoxidable/Polycarbonato
- ☞ Acciaio legato/Trasparente ☒ Acciaio legato/Polycarbonato

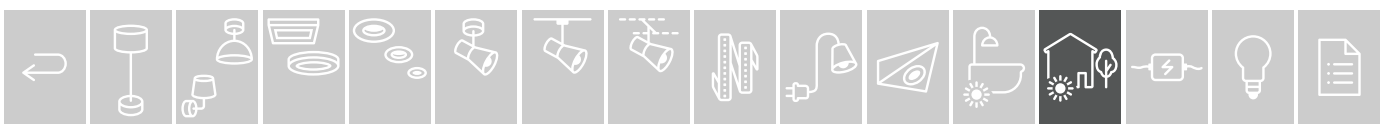



- ▶ In-ground luminaires with diffuse light for uniform orientation lighting at ground-level
- ▶ Standard paving stone dimensions
- ▶ Luminarias empotrables en el suelo con luz difusa para una luz de orientación uniforme desde el suelo
- ▶ Compatibles con las medidas usuales de los adoquines
- ▶ Faretto da incasso a pavimento con luce diffusa per un'illuminazione di orientamento uniforme proveniente dal pavimento stesso
- ▶ Adatto alle pietre per selciato di dimensioni comuni

**Solar Domenic**

incl. 1x0,1W  
8lm, 3.000K  
1xNiMh 1,2V AA  
∅37 ⇄80 ⇄80 mm  
EAN 4000870 945780

**945.78 new**

- 🔌 Black 📦 Plastic
- 🔌 Negro 📦 Plástico
- 🔌 Nero 📦 Plastica

**Solar Domenic**

incl. 1x0,1W  
8lm, 3.000K  
1x18650 Akku/3,7V  
∅37 ⇄200 ⇄80 mm  
EAN 4000870 945766

**945.76 new**

- 🔌 Black 📦 Plastic
- 🔌 Negro 📦 Plástico
- 🔌 Nero 📦 Plastica









► Can be charged via USB using an external power supply unit or powerbank

► Se puede cargar mediante USB con una fuente de alimentación externa o un power bank

► Ricaricabile via USB con alimentatore esterno o powerbank



#### Mobile Accu Lamp Cupulino

incl. 1x1,3 W  
135 lm, 3.000 K  
1x18650 Akku/3,7V  
DC 5 V  
∅184 ∅83 mm  
EAN 4000870 942673

**942.67**

↳ Transparent/Anthracite Plastic  
↳ Transparente/Antracita Plástico  
↳ Trasparente/Antracite Plastica



#### Mobile Accu Tablelamp Clutch

incl. 1x1,6 W  
172 lm, 3.000 K  
1x18650 Akku/3,7V  
DC 5 V  
∅120 ∅85 mm  
EAN 4000870 942109

**942.10**

↳ Grey Plastic  
↳ Gris Plástico  
↳ Grigio Plastica

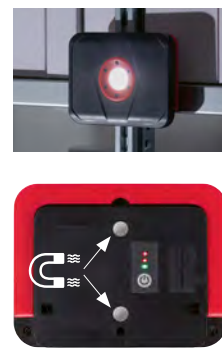

#### Mobile Akku Worklight 5W IP65

incl. 1x5 W  
440 lm, 6.500 K  
∠ 80°  
1x18650 Akku/3,7V  
DC 5 V  
∅131 ∅171 ∅39 mm  
EAN 4000870 942871

**942.87**

↳ Black/Red Plastic  
↳ Negro/Rojo Plástico  
↳ Nero/Rosso Plastica



#### Mobile Akku Worklight 15W IP65

incl. 1x15 W  
1.200 lm, 6.500 K  
∠ 80°  
1x18650 Akku/3,7V  
DC 5 V  
∅131 ∅171 ∅39 mm  
EAN 4000870 942888

**942.88**

↳ Black/Red Plastic  
↳ Negro/Rojo Plástico  
↳ Nero/Rosso Plastica

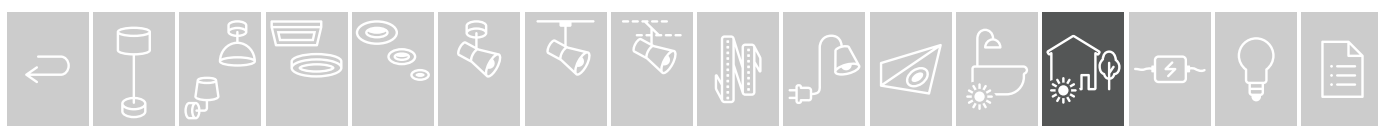



- ▶ Mini USB port and cable for charging the battery or for operating the luminaire from an external power supply unit or a powerbank when the battery is flat
- ▶ Conexión mini USB y cable para cargar la batería o para hacer funcionar la luminaria con la batería descargada con una fuente de alimentación externa o un power bank
- ▶ Attacco Mini USB e cavo per caricare la batteria o utilizzare la lampada in caso di batteria scarica con un alimentatore esterno o un powerbank



**Mobile Lampion Chain**

incl. 7x0,02 W  
7x1 lm, 3.000 K  
1x18650 Akku/3,7V  
DC 5 V  
ø73 mm ↔3,6 m  
EAN 4000870 941669

**941.66**

- White Plastic
- Blanco Plástico
- Bianco Plastica



**Mobile Lampion**

incl. 1x0,2 W  
16 lm, 3.000 K  
1x14500/ 3,7V  
DC 5 V  
∅170 ø140 mm  
EAN 4000870 941690

**941.69**

- White/Grey Plastic
- Blanco/Gris Plástico
- Bianco/Grigio Plastica



- ▶ LED-Strip for parasol illumination
- ▶ Operation with powerbank
- ▶ For indirect light in your garden seating area or on the patio
- ▶ Self-adhesive
- ▶ Strip LED para la iluminación de parasoles
- ▶ Para el uso en un power bank USB
- ▶ Para luz indirecta en el grupo de asientos en el jardín o la terraza
- ▶ Autoadhesivo
- ▶ Strip LED per illuminazione ombrellone
- ▶ Per l'impiego con powerbank USB
- ▶ Per una luce indiretta sul posto a sedere in giardino o in terrazza
- ▶ Autoadesivi



**Mobile Parasol Light**

incl. 4x0,45 W  
4x30 lm, 3.000 K  
DC 5 V  
∅3 mm ↔400 mm ↗5 mm ↔4x0,4 m  
EAN 4000870 942086

**942.08**

- Black Plastic
- Negro Plástico
- Nero Plastica



# Transformers



EN Transformers for any project  
ES Transformadores para todos los proyectos  
IT Trasformatori per ogni progetto

EN Our high-quality transformers offer solutions for any application – from flush-mounted models for recessed luminaires to power supplies for LED strips and toroidal transformers for cable systems. Protective features like overload protection, temperature monitors and short-circuit protectors guarantee a long product service life and safe operation.

ES Nuestros transformadores de alta calidad ofrecen soluciones para todas las aplicaciones: desde el modelo empotrable para luminarias incorporadas y fuentes de alimentación para strips LED hasta transformadores toroidales para sistemas de cables. Las funciones de protección, tales como la protección contra sobrecargas, el sensor de temperatura o la protección contra cortocircuito, garantizan una larga vida útil del producto y el funcionamiento seguro del mismo.

IT I nostri trasformatori di qualità offrono soluzioni per ogni applicazione: dal modello incassato a muro per faretti a incasso alle unità di alimentazione per Strips LED o ai trasformatori con nucleo toroidale per sistemi a filo. Le funzioni di protezione quali la protezione da sovraccarico, il controllo temperatura o la protezione da cortocircuito garantiscono una lunga durata del prodotto e il funzionamento sicuro.



EN Clever solutions for small spaces  
ES Soluciones inteligentes en espacios reducidos  
IT Soluzioni smart per spazi ridotti



☰=389

EN Easy retrofit from halogen to LED  
ES Conversión sencilla de halógeno a LED  
IT Semplice conversione da lampade alogene a LED

☰=390



EN The right models for LED strips  
ES Modelos adecuados para strips LED  
IT Modelli adatti per Strips LED

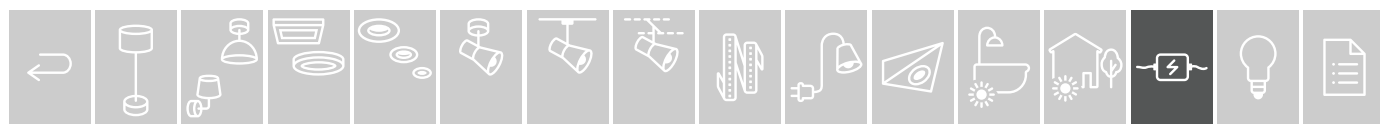

## VDE Disc Transformer 230/12V



- ▶ Disc transformers fit through round boreholes
- ▶ Can be dimmed with all dimmers (phases cut on/off)
- ▶ Los disc-trafos se encajan a través de agujeros circulares
- ▶ Regulable con todos los reguladores (de corte o inversión de fases)
- ▶ I trasformatori Disc si inseriscono in fori circolari
- ▶ Intensità regolabile con tutti i dimmer (a ritardo di fase e ad anticipo di fase)

**230/12V, 70 VA**

max. 20-70 W  
 ⌀23 ⌀55 mm  
 EAN 4000870 977286  
**977.28**

**230/12V, 105 VA**

max. 35-105 W  
 ⌀25 ⌀75 mm  
 EAN 4000870 977293  
**977.29**



## VDE Mipro Transformer 230/12V

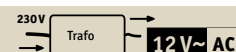

- ▶ Mipro transformers are designed for compact dimensions; they fit in the smallest installation spaces
- ▶ Ideal for recessed luminaires
- ▶ Can be used at an ambient temperature of up to 50°
- ▶ Can be dimmed with all dimmers (phases cut on/off)
- ▶ Los mipro-trafos han sido diseñados para las menores dimensiones y caben en los espacios de montaje más reducidos
- ▶ Ideal para luces empotradas
- ▶ Utilizable hasta 50° de temperatura ambiente
- ▶ Regulable con todos los reguladores (de corte o inversión de fases)
- ▶ I trasformatori Mipro sono concepiti con dimensioni minime e possono essere montati in spazi ridottissimi
- ▶ Ideale per luci da incasso
- ▶ Per temperature ambiente fino a 50°
- ▶ Intensità regolabile con tutti i dimmer (a ritardo di fase e ad anticipo di fase)

**230/12V, 70 VA**

max. 20-70 W  
 ⌀23 ⇄36 ⌀127 mm  
 EAN 4000870 977514  
**977.51**

**230/12V, 105 VA**

max. 35-105 W  
 ⌀30 ⇄38 ⌀137 mm  
 EAN 4000870 977538  
**977.53**

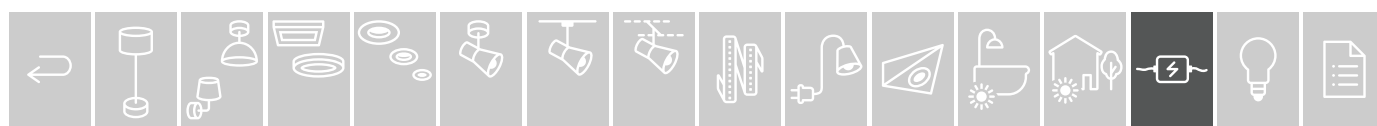

## VDE Flat Transformer 230/12V



- ▶ Flat transformers have an installation height of only 24 mm
- ▶ Problem solver for slightly suspended ceilings
- ▶ Ideal for mirror and gallery lighting and in furniture
- ▶ Can be dimmed with all dimmers (phases cut on/off)
- ▶ Los flat-trafos sobresalen sólo 24 mm
- ▶ Exentos de problemas incluso en techos de baja altura
- ▶ Ideal para luces de espejos, galerías y muebles
- ▶ Regulable con todos los reguladores (de corte o inversión de fases)
- ▶ I trasformatori Flat hanno un'altezza di soli 24 mm
- ▶ Soluzione ai problemi di spazi ridotti nei controsoffitti
- ▶ Ideale per specchi, quadri e integrazione nei mobili
- ▶ Intensità regolabile con tutti i dimmer (a ritardo di fase e ad anticipo di fase)

**230/12V, 70 VA**

max. 20-70 W  
 ⚡24 ↔50 ↻147 mm  
 EAN 4000870 977811  
**977.81**

**230/12V, 105 VA**

max. 35-105 W  
 ⚡24 ↔50 ↻147 mm  
 EAN 4000870 977828  
**977.82**



## VDE Profi Transformer 230/12V

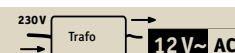

- ▶ Doubled primary connection for several transformers in a single switch
- ▶ Several secondary terminal pairs
- ▶ Max. 50 ° ambient temperature
- ▶ Suitable for NYM cable
- ▶ Captive strain relief and cap
- ▶ Middle outlet
- ▶ Can be dimmed with all dimmers (phases cut on/off)
- ▶ Doble conexión de primario para varios transformadores en un circuito
- ▶ Varios pares de bornes de secundario
- ▶ Hasta 50 ° de temperatura ambiente
- ▶ Aptos para cable NYM
- ▶ Capuchón y dispositivo antiaflojamiento imperdible
- ▶ Salida central
- ▶ Regulable con todos los reguladores (de corte o inversión de fases)
- ▶ Doppia connessione primaria per più trasformatori in un circuito
- ▶ Più coppie di morsetti per secondario
- ▶ Per temperature ambiente fino a 50 °
- ▶ Adatto per cavi NYM
- ▶ Scarico della trazione e coperchio imperdibili
- ▶ Uscita centrale
- ▶ Intensità regolabile con tutti i dimmer (a ritardo di fase e ad anticipo di fase)

**230/12V, 105 VA**

max. 35-105 W  
 ⚡27 ↔39 ↻161 mm  
 EAN 4000870 977019  
**977.01**

**230/12V, 150 VA**

max. 50-150 W  
 ⚡40 ↔48 ↻190 mm  
 EAN 4000870 977156  
**977.15**

**230/12V, 250 VA**

max. 100-250 W  
 ⚡44 ↔51 ↻222 mm  
 EAN 4000870 977255  
**977.25**

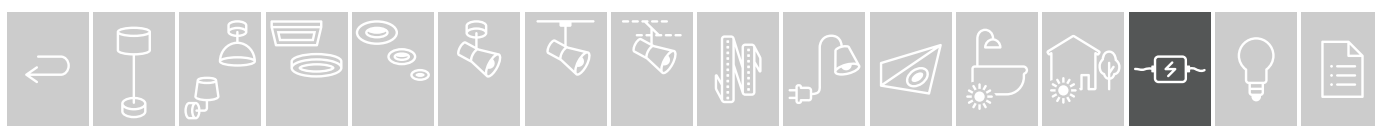

**Halo + LED Trafo 230/12V AC**

- |   |   |  |
|---|---|--|
| ▶ For halogen and LED                             | ▶ Para halógeno y LED                                     | ▶ Per Halogen e LED  |
| ▶ No minimum load                                 | ▶ Sin carga mínima  | ▶ Senza carico minimo                                      |
| ▶ Can be dimmed with reverse phase control dimmer | ▶ Intensidad regulable con reguladores de sección de fase | ▶ Intensità regolabile con dimmer a fase interrotta finale |

**220-240/12V, 50 VA**

max. 0-50 W  
 ⌀28 ⇄44 ⇄127 mm  
 EAN 4000870 977620  
**977.62**

**220-240/12V, 65 VA**

max. 0-65 W  
 ⌀28 ⇄44 ⇄127 mm  
 EAN 4000870 977675  
**977.67**



LED 12V = 396-398

977.62 max. 30W

977.67 max. 40W



Halogen 12V = 435

977.62 max. 50W

977.67 max. 65W

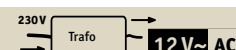
**Toroidal Decorative Transformer 230/12V****230/12V, 80 VA**

max. 80 W  
 ⌀86 ø145 mm  
 EAN 4000870 979327  
**979.32**

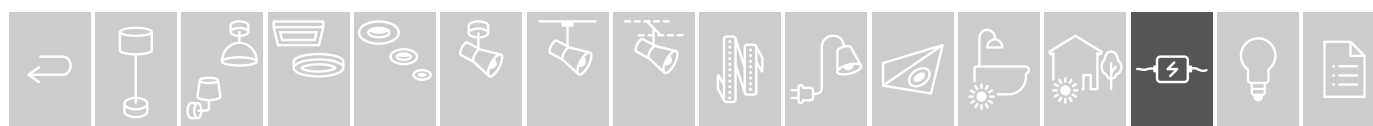
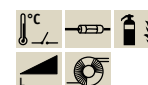

## Universal LED Power Supply 12W 12V DC



- ▶ Replacement power supply unit for LED strips
- ▶ 1 ampere
- ▶ < 0.5W standby power
- ▶ Incl. round connector – can be used for standard 12V LED strips
- ▶ Fuente de alimentación de repuesto para Strips LED
- ▶ 1 amperio
- ▶ Consumo en modo standby < 0,5W
- ▶ Incl. conector redondo; se puede usar para LED Strips estándares de 12 V
- ▶ Alimentatore sostitutivo per LED Strips
- ▶ Corrente continua 1 Ampere
- ▶ Consumo in standby < 0,5W
- ▶ Incluso connettore rotondo - può essere utilizzato per LED Strips standard 12V

**230/12V, 12 VA**

max. 12 W  
 ⌀63 ⇄40 ⌀26 mm  
 EAN 4000870 798324  
**798.32**

**230/12V, 36 VA**

max. 36 W  
 ⌀101 ⇄51 ⌀31 mm  
 EAN 4000870 798348  
**798.34**



## Power Supply 60W 12V DC

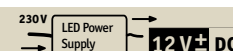

- ▶ Incl. 1 m primary supply line with Europlug & 2 m secondary supply line
- ▶ Incl. adapter plug (power plug) for 5.5 mm RGB connector
- ▶ Incl. 4-pin LED strip adapter – can be used for 12V LED strips
- ▶ < 0.5W standby power
- ▶ Incluye 1 m cable de alimentación primario con enchufe Euro y 2 m de cable secundario
- ▶ Incluye conector adaptador (Power Plug) de 5,5 mm conector hembra para RGB
- ▶ Incluye adaptador de 4 pines para Strip LED; se puede usar para LED Strips de 12 V
- ▶ Consumo en modo standby < 0,5W
- ▶ Include 1 m di linea di alimentazione primaria con spina Euro e 2 m di linea di alimentazione secondaria
- ▶ Incluso adattatore (Power Plug) di connettori da 5,5 mm per RGB
- ▶ Incl. incluso adattatore 4 pin LED Strip - può essere utilizzato per LED Strips 12V
- ▶ Consumo in standby < 0,5W

**230/12V, 60VA**

max. 60 W  
 ⌀35 ⇄60 ⌀130 mm  
 EAN 4000870 977637  
**977.63**

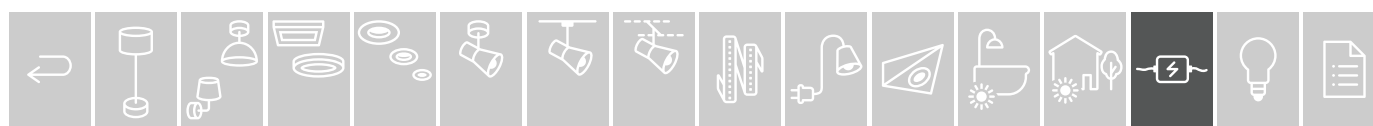



**LED-Driver Disc 350mA 10W max. 35V DC**

- ▶ Driver are specially designed for LED operation
- ▶ 350 mA constant current
- ▶ Las controladoras han sido específicamente diseñadas para el funcionamiento con LEDs
- ▶ 350 mA de corriente constante
- ▶ Driver concepiti appositamente per il funzionamento di LED
- ▶ Corrente costante a 350 mA

**230V, 10VA**

max. 5,5-10 W  
 ⌀24 ⌀52 mm  
 EAN 4000870 977385  
**977.38**

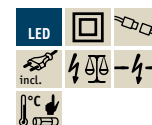
**PIR-Sensor 230V**

- ▶ Proximity switch for switching on and off the LED strips and other products
- ▶ Max. 75 W (magnetic transformers)
- ▶ Max. 60 W (electronic load)
- ▶ Max. 250 W (light bulbs)
- ▶ For connection to 230 V cable
- ▶ Interruptor de proximidad para encender/apagar regletas LED-strips y otros productos
- ▶ Máx. 75 W (transformadores magnéticos)
- ▶ Máx. 60 W (carga electrónica)
- ▶ Máx. 250 W (lámparas incandescentes)
- ▶ Para la conexión a un cable de 230V
- ▶ L'interruttore di prossimità accende o spegne le strisce LED e altri prodotti
- ▶ Max. 75 W (trasformatori magnetici)
- ▶ Max. 60 W (carico elettronico)
- ▶ Max. 250 W (lampadine a incandescenza)
- ▶ Per collegamento al cavo da 230V

**230V**

max. 60 W  
 ⌀19 ⌀17,5 ⌀85 ⌀36 mm  
 EAN 4000870 704516  
**704.51**

(mm)

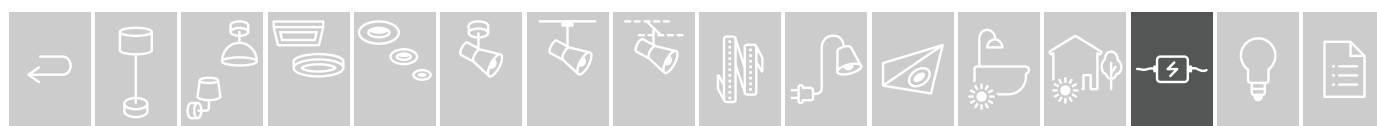
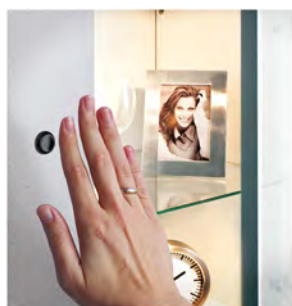
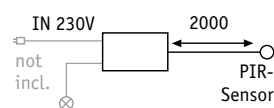
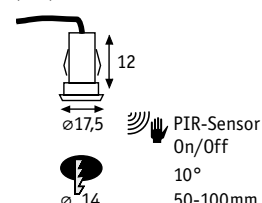

# Lamps

- 397 LED Standard 12V
- 399 LED Standard 230V
- 405 LED Standard Filament 230V
- 412 LED Decorative
- 430 LED Smart Home
- 433 Energy Saver / Tube fluorescent
- 435 Halogen 12V
- 435 Halogen 230V
- 436 Conventional Lamps



EN Gold glass lamps with engraved light cylinder  
 ES Lámparas de vidrio dorado con cilindro grabado  
 IT Lampade in vetro dorato con cilindro luminoso inciso  
 ► 1800 K extra warm white



EN Luxurious gold glass lamps  
 ES Elegantes lámparas de vidrio dorado  
 IT Raffinate lampade con vetro dorato  
 ► 2500–2700 K warm white

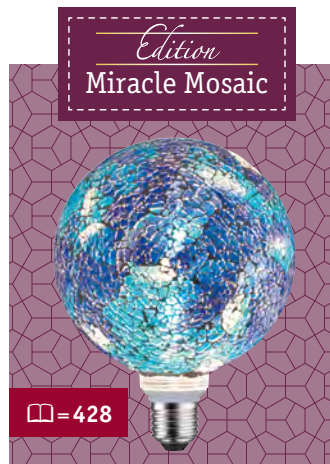

EN All-glass lamps with mosaic glass  
 ES Ampollas de vidrio con mosaico de cristal  
 IT Lampade completamente in vetro con mosaici in vetro  
 ► 2700 K warm white  
 ► Dimmable



EN Decorative GU5.3 and GU10 reflectors and filament lamps in many colours  
 ES Decorativos reflectores GU5,3 y GU10 y lámparas de filamentos en numerosos colores  
 IT Riflettori e lampade a filamento decorativi GU5,3 e GU10 in svariati colori



1879 Edition



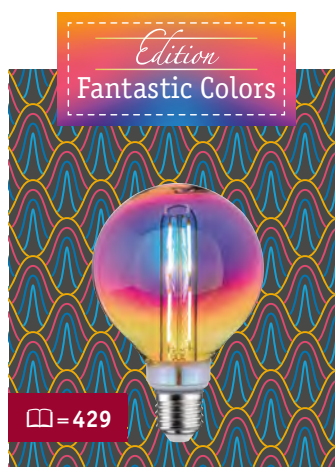

*Edison*  
Fantastic Colors

☞ = 429

EN Special effect glass with gorgeous rainbow effects  
ES Cristal con efectos especiales para un efecto de arco iris mágico  
IT Vetro dall'effetto speciale con effetto arcobaleno

- ▶ 2700 K warm white
- ▶ Dimmable

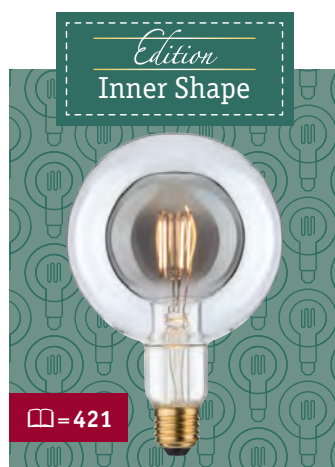

*Edison*  
Inner Shape

☞ = 421

EN Decorative glass encased in clear glass  
ES Cristal decorado envuelto en cristal claro  
IT Un vetro trasparente avvolge il vetro decorativo

- ▶ 2700 K warm white
- ▶ Dimmable

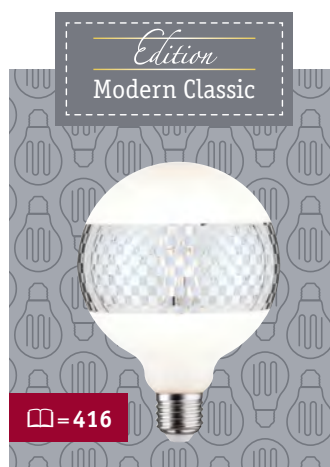

*Edison*  
Modern Classic

☞ = 416

EN Crown and ring mirror lamps  
ES Lámparas con espejado de cúpula y anular  
IT Lampade con testina e anello a specchio

- ▶ 2500–2700 K warme white



*Edison*  
Grow Green

☞ = 432

EN Special colour spectrum promotes the growth of indoor plants  
ES Espectro de colores especial para el crecimiento de plantas de interior  
IT Speciale spettro cromatico per la crescita delle piante da interno

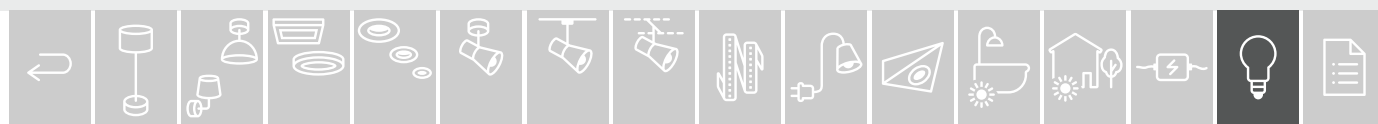



## Find the right lamp







## Encuentra la lámpara adecuada

## Trova la lampadina giusta

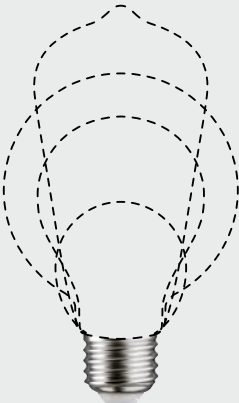
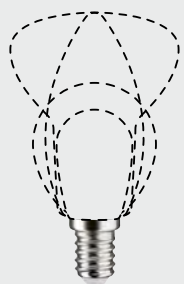
Base overview: The right lamp for your luminaire

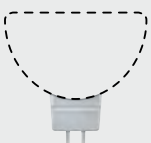
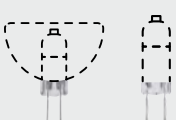
Vista general de casquillos: la lámpara adecuada para tu luminaria

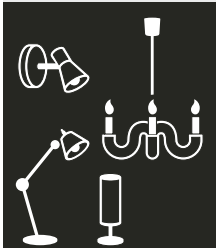
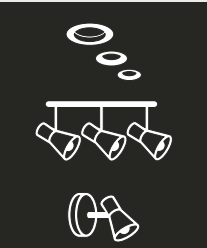
Panoramica delle basi: la lampadina giusta per la vostra lampada

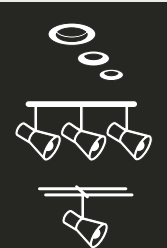
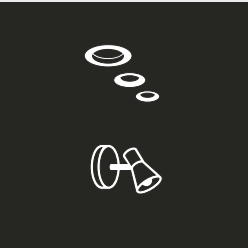
230V				12V	
					
<b>E27</b>	<b>E14</b>	<b>GU10</b>	<b>G9</b>	<b>GU5,3</b>	<b>GU4/G4 GY6,35</b>
					

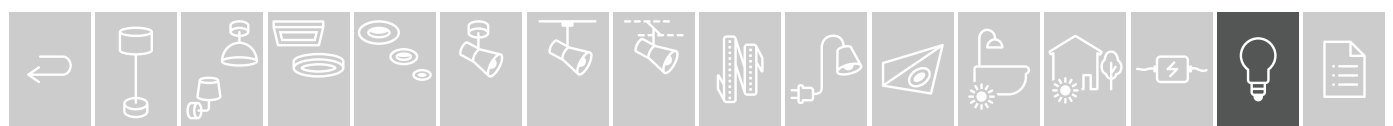







## LED Standard 12V

## White Blanco Bianco



	W	⊖	∅ mm	⇅ mm	lm	↗	K	⌚	EAN	☑	
<b>A F</b>	<b>2,5</b>	G4	22	33	250		2.700	15.000	4000870 288115	☑	<b>288.11</b>
	3,5 VA										



	W	⊖	∅ mm	⇅ mm	lm	↗	K	⌚	EAN	☑	
<b>A G</b>	<b>3,2</b>	G4	30	41	270		2.700	15.000	4000870 287750	☑	<b>287.75</b>
	3,2 VA										

## Clear Transparente Trasparente



	W	⊖	∅ mm	⇅ mm	lm	↗	K	⌚	EAN	☑	
<b>A F</b>	<b>3</b>	G4	17	47	300		4.000	15.000	4000870 288184	☑	<b>288.18</b>
	4,2 VA										

## Clear Transparente Trasparente



	W	⊖	∅ mm	⇅ mm	lm	↗	K	⌚	EAN	☑	
<b>A F</b>	<b>3</b>	G4	17	47	300		2.700	15.000	4000870 288139	☑	<b>288.13</b>
	4,2 VA										
<b>A F</b>	<b>3x3</b>	G4	17	47	300		2.700	15.000	4000870 288146	☑	<b>288.14</b>
	4,2 VA										

## Clear Transparente Trasparente



	W	⊖	∅ mm	⇅ mm	lm	↗	K	⌚	EAN	☑	
<b>A G</b>	<b>4</b>	G4	16	55	350		2.700	15.000	4000870 288252	☑	<b>new 288.25</b>
	5,5 VA										

## Clear Transparente Trasparente



	W	⊖	∅ mm	⇅ mm	lm	↗	K	⌚	EAN	☑	
<b>A F</b>	<b>4</b>	GY6,35	18	50	400		2.700	25.000	4000870 288337	☑	<b>new 288.33</b>
	5,5 VA										

## Clear Transparente Trasparente



	W	⊖	∅ mm	⇅ mm	lm	↗	K	⌚	EAN	☑	
<b>A G</b>	<b>3,5</b>	GY6,35	17	47	300		2.700	15.000	4000870 288214	☑	<b>288.21</b>
	4,5 VA										
<b>A G</b>	<b>3x3,5</b>	GY6,35	17	47	300		2.700	15.000	4000870 288221	☑	<b>288.22</b>
	4,5 VA										

## Clear Transparente Trasparente



	W	⊖	∅ mm	⇅ mm	lm	↗	K	⌚	EAN	☑	
<b>A F</b>	<b>3</b>	GY6,35	17	47	300		4.000	15.000	4000870 288245	☑	<b>288.24</b>
	4,2 VA										

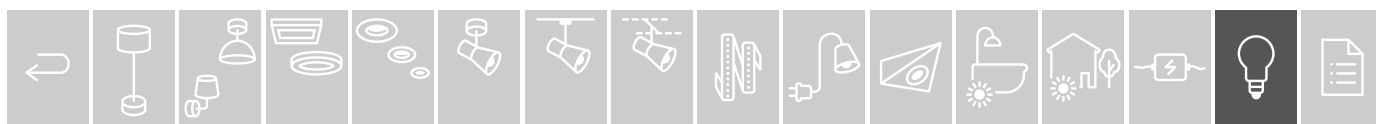



Black matt Negro mate Nero opaco



dimmable

	W	⊖	∅ mm	⇅ mm	lm	⚡	K	⌚	EAN	✓	
<b>A G</b>	<b>6,5</b>	GU5,3	50	48	445	36	2.700	15.000	4000870 287576	✓	<b>287.57</b>
	6,6 VA										
<b>A G</b>	<b>6,5</b>	GU5,3	50	48	445	38	4.000	15.000	4000870 288726	✓	<b>new 288.72</b>
	7 VA										

Matt white Blanco mate Bianco opaco



dimmable

	W	⊖	∅ mm	⇅ mm	lm	⚡	K	⌚	EAN	✓	
<b>A G</b>	<b>6,5</b>	GU5,3	50	48	445	36	2.700	15.000	4000870 287583	✓	<b>287.58</b>
	6,6 VA										
<b>A G</b>	<b>6,5</b>	GU5,3	50	48	445	38	4.000	15.000	4000870 288733	✓	<b>new 288.73</b>
	7 VA										

Chrome matt Cromo mate Cromo opaco



dimmable

	W	⊖	∅ mm	⇅ mm	lm	⚡	K	⌚	EAN	✓	
<b>A G</b>	<b>6,5</b>	GU5,3	50	48	445	36	2.700	15.000	4000870 287590	✓	<b>287.59</b>
	6,6 VA										
<b>A G</b>	<b>6,5</b>	GU5,3	50	48	445	38	4.000	15.000	4000870 288740	✓	<b>new 288.74</b>
	7 VA										

Maxiflood

Radiates evenly in every direction (ideal for colored lamp shades)

Maxiflood

Alumbra circularmente en todas las direcciones (ideal para pantallas de color)

Maxiflood

Illuminazione omogenea a 360 gradi (ideale per i paralumi colorati)

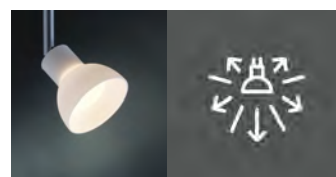

Soft opal Ópalo suave Opale tenue



	W	⊖	∅ mm	⇅ mm	lm	⚡	K	⌚	EAN	✓	
<b>A G</b>	<b>1,8</b>	GU4	35	33	100		2.700	15.000	4000870 283295	✓	<b>283.29</b>
	2 VA										

Maxiflood



	W	⊖	∅ mm	⇅ mm	lm	⚡	K	⌚	EAN	✓	
<b>A G</b>	<b>3</b>	GU5,3	51	45	220		2.700	15.000	4000870 283301	✓	<b>283.30</b>
	4 VA										

Juwel

Brilliant light shines to the front, while shimmering satin-coloured light reflects to the rear.

Juwel

Hacia delante se irradia una luz brillante y hacia atrás se muestran reflejos con un brillo satinado.

Juwel

Irradia in avanti una luce brillante, e all'indietro riflessi brillanti e satinati.



Silver Plateado Argento



Juwel

	W	⊖	∅ mm	⇅ mm	lm	⚡	K	⌚	EAN	✓	
<b>A G</b>	<b>3</b>	GU5,3	50	48	230	38	2.700	15.000	4000870 289105	✓	<b>new 289.10</b>
	4 VA										

Aluminium Aluminio Alluminio



AR 111

	W	⊖	∅ mm	⇅ mm	lm	⚡	K	⌚	EAN	✓	
<b>A G</b>	<b>8</b>	G53	111	56	500	24	2.700	15.000	4000870 285152	✓	<b>285.15</b>
	10,5 VA										

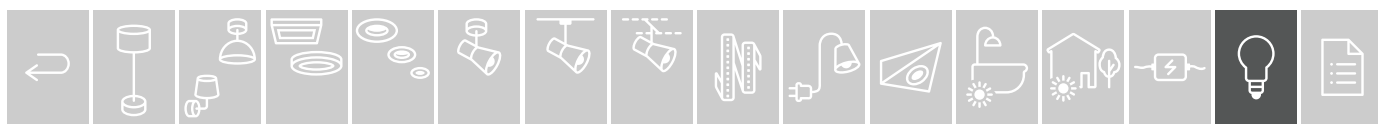





## LED Standard 230 V

Opal Opal Opale



	W	⊖	∅ mm	⇅ mm	lm	↗	K	⌚	EAN	☑	
<b>A</b> <b>G</b>	3x3,5	E14	35	100	250		2.700	15.000	4000870 284261	✓	284.26
<b>A</b> <b>F</b>	3x5,5	E14	35	100	470		2.700	15.000	4000870 285381	✓	285.38



	W	⊖	∅ mm	⇅ mm	lm	↗	K	⌚	EAN	☑	
<b>A</b> <b>G</b>	3x3,5	E14	45	80	250		2.700	15.000	4000870 284278	✓	284.27
<b>A</b> <b>F</b>	3x5,5	E14	45	81	470		2.700	15.000	4000870 285374	✓	285.37



	W	⊖	∅ mm	⇅ mm	lm	↗	K	⌚	EAN	☑	
<b>A</b> <b>G</b>	3x3,5	E27	45	82	250		2.700	15.000	4000870 285787	✓	285.78
<b>A</b> <b>F</b>	3x5,5	E27	45	82	470		2.700	15.000	4000870 285794	✓	285.79



	W	⊖	∅ mm	⇅ mm	lm	↗	K	⌚	EAN	☑	
<b>A</b> <b>F</b>	3x8,0	E27	60	105	806		2.700	15.000	4000870 288719	✓	new 288.71



	W	⊖	∅ mm	⇅ mm	lm	↗	K	⌚	EAN	☑	
<b>A</b> <b>F</b>	3x5,5	E14	50	86	450	120	2.700	15.000	4000870 285800	✓	285.80

R50



	W	⊖	∅ mm	⇅ mm	lm	↗	K	⌚	EAN	☑	
<b>A</b> <b>F</b>	9,5	E27	80	114	900	110	2.700	25.000	4000870 284445	✓	284.44

R80

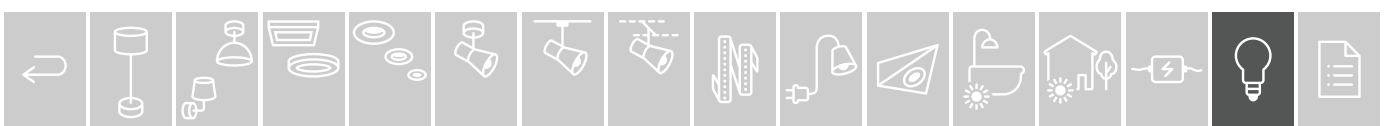



**3 step dim**

Clear Transparente Trasparente

ATG	W	⊖	∅ mm	⇅ mm	lm	✂	K	⌚	EAN	✓	Price
F	4	G9	18	55	350		2.700	15.000	4000870 287965		<b>287.96</b>



**dim to warm**

Clear Transparente Trasparente

ATG	W	⊖	∅ mm	⇅ mm	lm	✂	K	⌚	EAN	✓	Price
G	4	G9	18	55	270		2.000 - 3.000	15.000	4000870 288191		<b>288.19</b>



**tunable white**

Clear Transparente Trasparente

ATG	W	⊖	∅ mm	⇅ mm	lm	✂	K	⌚	EAN	✓	Price
G	4	G9	18	55	300		2.200 - 6.500	15.000	4000870 288207		<b>288.20</b>



Clear Transparente Trasparente

ATG	W	⊖	∅ mm	⇅ mm	lm	✂	K	⌚	EAN	✓	Price
F	5	G9	18	70	470		4.000	15.000	4000870 287996		<b>287.99</b>

ATG	W	⊖	∅ mm	⇅ mm	lm	✂	K	⌚	EAN	✓	Price
F	3x5	G9	18	70	470		4.000	15.000	4000870 288016		<b>288.01</b>



**dimmable**

ATG	W	⊖	∅ mm	⇅ mm	lm	✂	K	⌚	EAN	✓	Price
F	5	G9	18	70	470		4.000	15.000	4000870 288009		<b>288.00</b>



**dimmable**

Clear Transparente Trasparente

ATG	W	⊖	∅ mm	⇅ mm	lm	✂	K	⌚	EAN	✓	Price
F	6	G9	18	70	550		2.700	15.000	4000870 288061		<b>288.06</b>



Clear Transparente Trasparente

ATG	W	⊖	∅ mm	⇅ mm	lm	✂	K	⌚	EAN	✓	Price
F	2,5	G9	18	66	250		2.700	15.000	4000870 288092		<b>new 288.09</b>

ATG	W	⊖	∅ mm	⇅ mm	lm	✂	K	⌚	EAN	✓	Price
F	3x2,5	G9	18	66	250		2.700	15.000	4000870 288108		<b>new 288.10</b>



Clear Transparente Trasparente

ATG	W	⊖	∅ mm	⇅ mm	lm	✂	K	⌚	EAN	✓	Price
E	4,5	G9	18	76	550		2.700	15.000	4000870 288344		<b>new 288.34</b>



Clear Transparente Trasparente

ATG	W	⊖	∅ mm	⇅ mm	lm	✂	K	⌚	EAN	✓	Price
F	2,5	G9	17	50	250		2.700	15.000	4000870 288078		<b>new 288.07</b>

ATG	W	⊖	∅ mm	⇅ mm	lm	✂	K	⌚	EAN	✓	Price
F	3x2,5	G9	17	50	250		2.700	15.000	4000870 288085		<b>new 288.08</b>

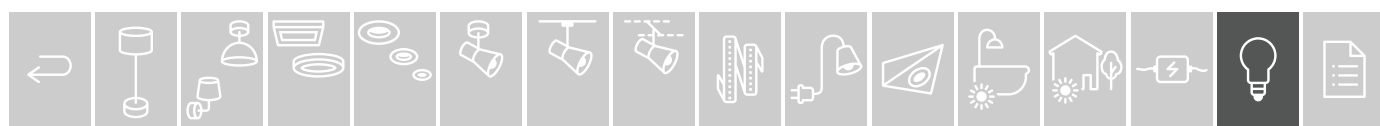

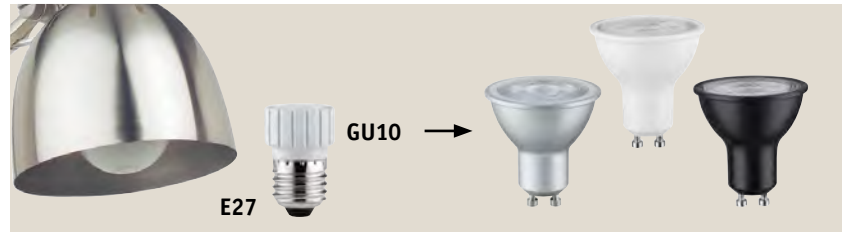

White Blanco Bianco

W	⊖	∅ mm	⇅ mm	lm	⚡	K	⌚	EAN	☑	💰
max. 50	GU10 / E27	35	53					4000870 549292	✓	549.29



Black matt Negro mate Nero opaco



dimmmable

W	⊖	∅ mm	⇅ mm	lm	⚡	K	⌚	EAN	☑	💰
7	GU10	51	54	460	36	2.700	15.000	4000870 287514	✓	287.51
7	GU10	51	54	460	36	4.000	15.000	4000870 287545	✓	287.54

Matt white Blanco mate Bianco opaco



dimmmable

W	⊖	∅ mm	⇅ mm	lm	⚡	K	⌚	EAN	☑	💰
7	GU10	51	54	460	36	2.700	15.000	4000870 287521	✓	287.52
7	GU10	51	54	460	36	4.000	15.000	4000870 287552	✓	287.55

Chrome matt Cromo mate Cromo opaco



dimmmable

W	⊖	∅ mm	⇅ mm	lm	⚡	K	⌚	EAN	☑	💰
7	GU10	51	54	460	36	2.700	15.000	4000870 287538	✓	287.53
7	GU10	51	54	460	36	4.000	15.000	4000870 287569	✓	287.56





White Blanco Bianco

W	⊖	∅ mm	⇅ mm	lm	⚡	K	⌚	EAN	✓	Price
<b>6</b>	GU10	50	54	350	36	1.800 - 3.000	15.000	4000870 287354	✓	<b>287.35</b>



White Blanco Bianco

W	⊖	∅ mm	⇅ mm	lm	⚡	K	⌚	EAN	✓	Price
<b>6,5</b>	GU10	51	56	460	38	2.700	15.000	4000870 285770	✓	<b>285.77</b>



White Blanco Bianco

W	⊖	∅ mm	⇅ mm	lm	⚡	K	⌚	EAN	✓	Price
<b>5,9</b>	GU10	50	56	470	110	2.700 - 6.500	15.000	4000870 287972	✓	<b>287.97</b>



White Blanco Bianco

W	⊖	∅ mm	⇅ mm	lm	⚡	K	⌚	EAN	✓	Price
<b>5,5</b>	GU10	50	56	460	110	2.700	15.000	4000870 287989	✓	<b>287.98</b>



Aluminium Aluminio Alluminio

W	⊖	∅ mm	⇅ mm	lm	⚡	K	⌚	EAN	✓	Price
<b>3x4</b>	GU10	51	55	230	36	2.700	15.000	4000870 285817	✓	<b>285.81</b>

W	⊖	∅ mm	⇅ mm	lm	⚡	K	⌚	EAN	✓	Price
<b>3x6,5</b>	GU10	51	54	425	38	2.700	15.000	4000870 284308	✓	<b>284.30</b>



QPAR 111

Aluminium Aluminio Alluminio

W	⊖	∅ mm	⇅ mm	lm	⚡	K	⌚	EAN	✓	Price
<b>4</b>	GU10	111	70	350	24	2.700	15.000	4000870 285145	✓	<b>285.14</b>



Silver Plateado Argentó

W	⊖	∅ mm	⇅ mm	lm	⚡	K	⌚	EAN	✓	Price
<b>13,8</b>	E27	122	134	1.000	30	3.000	25.000	4000870 288269	✓	<b>new 288.26</b>

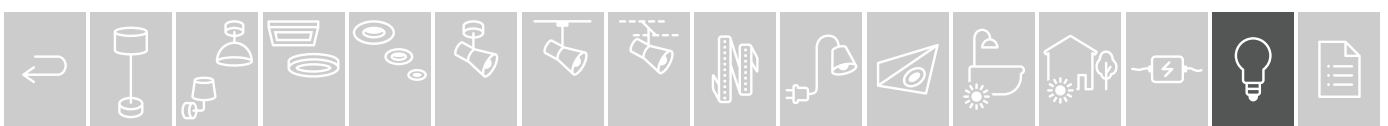



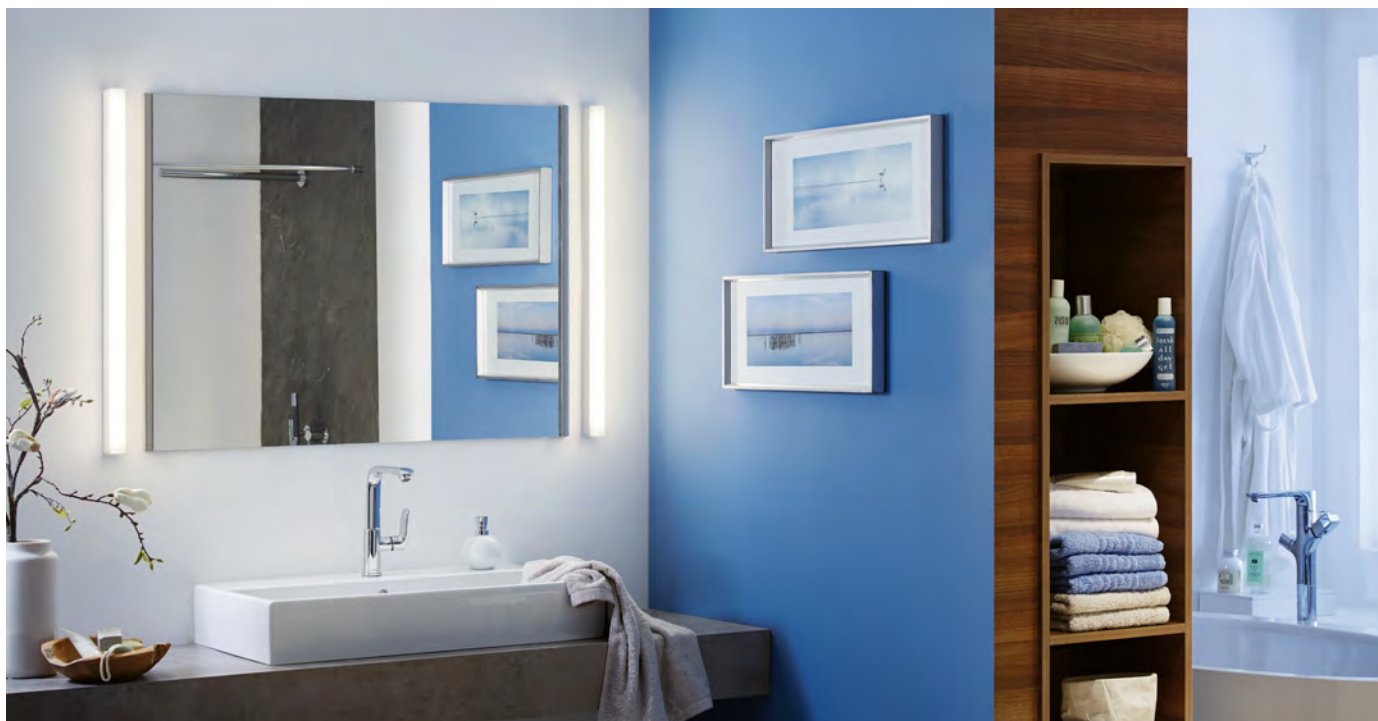

► For conventional ballasts only

► Solo para estabilizadores convencionales

► Solo per alimentatori convenzionali



Opal Opal Opale

	W	⊖	∅ mm	⇅ mm	lm	↗	K	⌚	EAN	📦
<b>ATG F</b>	<b>9,5</b>	G13	28	604	850		4.000	15.000	4000870 289020	<b>new 289.02</b>

incl.

	W	⊖	∅ mm	⇅ mm	lm	↗	K	⌚	EAN	📦
<b>ATG F</b>	<b>18</b>	G13	28	1.214	1.800		4.000	15.000	4000870 289037	<b>new 289.03</b>



T8

	W	⊖	∅ mm	⇅ mm	lm	↗	K	⌚	EAN	📦
<b>ATG F</b>	<b>22,5</b>	G13	28	1.514	2.200		4.000	15.000	4000870 289044	<b>new 289.04</b>

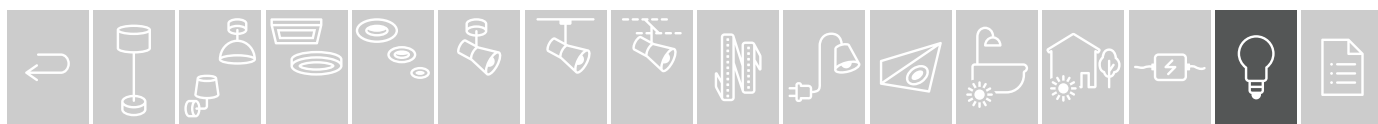







## LED Standard Filament 230 V

Clear Transparente Trasparente



	W	⚡	∅ mm	⇅ mm	lm	♀	K	⌚	EAN	✓	
 <b>F</b>	2,6	E14	35	98	250		2.700	15.000	4000870 286838	✓	<b>286.83</b>
 <b>F</b>	4,5	E14	35	98	470		2.700	15.000	4000870 286111	✓	<b>286.11</b>
 <b>E</b>	6,5	E14	35	97	806		2.700	20.000	4000870 286432	✓	<b>286.43</b>
	W	⚡	∅ mm	⇅ mm	lm	♀	K	⌚	EAN	✓	
 <b>F</b>	2x2,7	E14	35	97	250		2.700	15.000	4000870 288559	✓	<b>new 288.55</b>
 <b>F</b>	2x4,5	E14	35	98	470		2.700	15.000	4000870 287880	✓	<b>287.88</b>

Clear Transparente Trasparente

 dimmable

	W	⚡	∅ mm	⇅ mm	lm	♀	K	⌚	EAN	✓	
 <b>F</b>	4,8	E14	35	98	470		2.700	15.000	4000870 286845	✓	<b>286.84</b>

R, C

 3 step touch dim

	W	⚡	∅ mm	⇅ mm	lm	♀	K	⌚	EAN	✓	
 <b>F</b>	5	E14	35	80	432		2.700	15.000	4000870 287385	✓	<b>287.38</b>

3 step touch dim

 3 step dim

	W	⚡	∅ mm	⇅ mm	lm	♀	K	⌚	EAN	✓	
 <b>F</b>	2,7	E14	35	97	250		2.700	15.000	4000870 285725	✓	<b>285.72</b>

3 step dim

 dim to warm

	W	⚡	∅ mm	⇅ mm	lm	♀	K	⌚	EAN	✓	
 <b>F</b>	5	E14	35	117	470		1.800 - 3.000	15.000	4000870 287774	✓	<b>287.77</b>

R, L, C

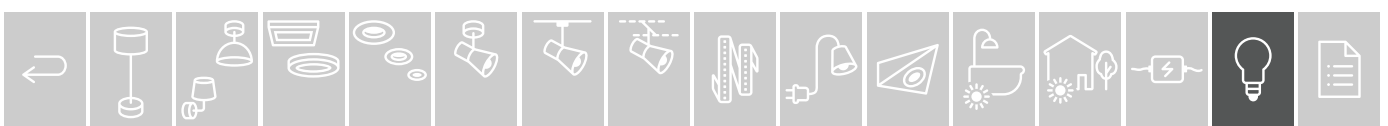



Matt Mate Opaco

	W	⊖	∅ mm	⇅ mm	lm	✂	K	⌚	EAN	✓	
<b>A</b> <b>G</b>	3	E14	35	98	250		2.700	15.000	4000870 286104	✓	<b>286.10</b>
<b>A</b> <b>F</b>	4,5	E14	35	98	470		2.700	15.000	4000870 286128	✓	<b>286.12</b>
<b>A</b> <b>E</b>	6,5	E14	35	98	806		2.700	15.000	4000870 286456	✓	<b>286.45</b>



	W	⊖	∅ mm	⇅ mm	lm	✂	K	⌚	EAN	✓	
<b>A</b> <b>G</b>	2x3	E14	35	98	250		2.700	15.000	4000870 286364	✓	<b>286.36</b>
<b>A</b> <b>F</b>	2x5	E14	35	98	470		2.700	15.000	4000870 286371	✓	<b>286.37</b>



 dimmable

	W	⊖	∅ mm	⇅ mm	lm	✂	K	⌚	EAN	✓	
<b>A</b> <b>F</b>	5	E14	35	98	470		2.700	15.000	4000870 286135	✓	<b>286.13</b>

 R.C.



Clear Transparente Trasparente

 dimmable

	W	⊖	∅ mm	⇅ mm	lm	✂	K	⌚	EAN	✓	
<b>A</b> <b>F</b>	2,8	E14	35	120	250		2.700	15.000	4000870 286869	✓	<b>286.86</b>
<b>A</b> <b>F</b>	4,8	E14	35	120	470		2.700	15.000	4000870 286876	✓	<b>286.87</b>

 R.C.



Satin Satinado Satinato

 dimmable

	W	⊖	∅ mm	⇅ mm	lm	✂	K	⌚	EAN	✓	
<b>A</b> <b>F</b>	2,6	E14	35	120	250		2.700	15.000	4000870 286852	✓	<b>286.85</b>

	W	⊖	∅ mm	⇅ mm	lm	✂	K	⌚	EAN	✓	
<b>A</b> <b>F</b>	4,8	E14	35	120	470		2.700	15.000	4000870 286883	✓	<b>286.88</b>

 R.C.



 dimmable

Matt/White Mate/Blanco Opaco/Bianco

	W	⊖	∅ mm	⇅ mm	lm	✂	K	⌚	EAN	✓	
<b>A</b> <b>F</b>	5	E14	35	98	470		4.000	15.000	4000870 287279	✓	<b>287.27</b>

 R.C.



 dimmable

Matt Mate Opaco

	W	⊖	∅ mm	⇅ mm	lm	✂	K	⌚	EAN	✓	
<b>A</b> <b>F</b>	5	E14	35	98	470		6.500	15.000	4000870 287606	✓	<b>287.60</b>

 R.C.

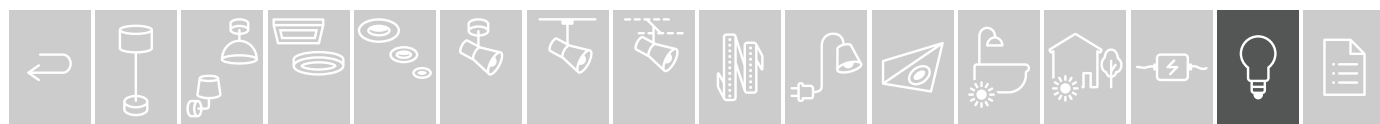





## Clear Transparente Trasparente

	W	⊖	∅ mm	⇅ mm	lm	✂	K	⌚	EAN	✓	
<b>A T G</b> <b>F</b>	2,6	E14	45	78	250		2.700	15.000	4000870 286890	✓	286.89

<b>A T G</b> <b>F</b>	5	E14	45	78	470		2.700	15.000	4000870 286302	✓	286.30
-----------------------	---	-----	----	----	-----	--	-------	--------	----------------	---	--------

<b>A T G</b> <b>E</b>	6,5	E14	45	85	806		2.700	20.000	4000870 286500	✓	286.50
-----------------------	-----	-----	----	----	-----	--	-------	--------	----------------	---	--------



	W	⊖	∅ mm	⇅ mm	lm	✂	K	⌚	EAN	✓	
<b>A T G</b> <b>F</b>	2x2,7	E14	45	81	250		2.700	15.000	4000870 288573	✓	new 288.57



## Clear Transparente Trasparente



	W	⊖	∅ mm	⇅ mm	lm	✂	K	⌚	EAN	✓	
<b>A T G</b> <b>F</b>	4,8	E14	45	78	470		2.700	15.000	4000870 286906	✓	286.90



	W	⊖	∅ mm	⇅ mm	lm	✂	K	⌚	EAN	✓	
<b>A T G</b> <b>F</b>	5	E14	45	97	432		2.700	15.000	4000870 287392	✓	287.39



	W	⊖	∅ mm	⇅ mm	lm	✂	K	⌚	EAN	✓	
<b>A T G</b> <b>F</b>	2,7	E14	45	80	250		2.700	15.000	4000870 285732	✓	285.73



	W	⊖	∅ mm	⇅ mm	lm	✂	K	⌚	EAN	✓	
<b>A T G</b> <b>F</b>	5	E14	45	99	470		1.800 - 3.000	15.000	4000870 287781	✓	287.78



## Clear Transparente Trasparente



	W	⊖	∅ mm	⇅ mm	lm	✂	K	⌚	EAN	✓	
<b>A T G</b> <b>F</b>	2,6	E27	45	72	250		2.700	15.000	4000870 286913	✓	286.91

<b>A T G</b> <b>F</b>	5	E27	45	72	470		2.700	15.000	4000870 286333	✓	286.33
-----------------------	---	-----	----	----	-----	--	-------	--------	----------------	---	--------

<b>A T G</b> <b>E</b>	6,5	E27	45	78	806		2.700	20.000	4000870 286548	✓	286.54
-----------------------	-----	-----	----	----	-----	--	-------	--------	----------------	---	--------



	W	⊖	∅ mm	⇅ mm	lm	✂	K	⌚	EAN	✓	
<b>A T G</b> <b>F</b>	2x5	E27	45	72	470		2.700	15.000	4000870 286401	✓	286.40



	W	⊖	∅ mm	⇅ mm	lm	✂	K	⌚	EAN	✓	
<b>A T G</b> <b>F</b>	4,8	E27	45	72	470		2.700	15.000	4000870 286920	✓	286.92

<b>A T G</b> <b>E</b>	6,5	E27	45	78	800		2.700	20.000	4000870 286555	✓	286.55
-----------------------	-----	-----	----	----	-----	--	-------	--------	----------------	---	--------



Matt Mate Opaco



	W	⊖	∅ mm	⇅ mm	lm	✂	K	⊕	EAN	✓	
<b>A G</b> <b>G</b>	3	E14	45	78	250		2.700	15.000	4000870 286296	✓	<b>286.29</b>
<b>A G</b> <b>F</b>	5	E14	45	78	470		2.700	15.000	4000870 286319	✓	<b>286.31</b>
<b>A G</b> <b>E</b>	6,5	E14	45	80	806		2.700	15.000	4000870 286524	✓	<b>286.52</b>



	W	⊖	∅ mm	⇅ mm	lm	✂	K	⊕	EAN	✓	
<b>A G</b> <b>G</b>	2x3	E14	45	78	250		2.700	15.000	4000870 286388	✓	<b>286.38</b>
<b>A G</b> <b>F</b>	2x4,5	E14	45	78	470		2.700	15.000	4000870 287897	✓	<b>287.89</b>



dimmable

	W	⊖	∅ mm	⇅ mm	lm	✂	K	⊕	EAN	✓	
<b>A G</b> <b>F</b>	5	E14	45	78	470		2.700	15.000	4000870 286326	✓	<b>286.32</b>



dimmable

Matt Mate Opaco

	W	⊖	∅ mm	⇅ mm	lm	✂	K	⊕	EAN	✓	
<b>A G</b> <b>F</b>	5	E14	45	78	470		4.000	15.000	4000870 287286	✓	<b>287.28</b>



dimmable

Matt Mate Opaco

	W	⊖	∅ mm	⇅ mm	lm	✂	K	⊕	EAN	✓	
<b>A G</b> <b>F</b>	5	E14	45	78	470		6.500	15.000	4000870 287613	✓	<b>287.61</b>



Matt Mate Opaco

	W	⊖	∅ mm	⇅ mm	lm	✂	K	⊕	EAN	✓	
<b>A G</b> <b>F</b>	5	E27	45	75	470		2.700	15.000	4000870 286340	✓	<b>286.34</b>
<b>A G</b> <b>E</b>	6,5	E27	45	85	806		2.700	15.000	4000870 286562	✓	<b>286.56</b>



	W	⊖	∅ mm	⇅ mm	lm	✂	K	⊕	EAN	✓	
<b>A G</b> <b>F</b>	2x5	E27	45	78	470		2.700	15.000	4000870 286395	✓	<b>286.39</b>



dimmable

	W	⊖	∅ mm	⇅ mm	lm	✂	K	⊕	EAN	✓	
<b>A G</b> <b>F</b>	5	E27	45	72	470		2.700	15.000	4000870 286357	✓	<b>286.35</b>
<b>A G</b> <b>E</b>	6,5	E27	45	78	800		2.700	20.000	4000870 286579	✓	<b>286.57</b>



dimmable

Clear Transparente Trasparente

	W	⊖	∅ mm	⇅ mm	lm	✂	K	⊕	EAN	✓	
<b>A G</b> <b>F</b>	2,8	E14	25	82	250		2.700	15.000	4000870 286944	✓	<b>286.94</b>
<b>A G</b> <b>F</b>	4,8	E14	25	82	470		2.700	15.000	4000870 286937	✓	<b>286.93</b>

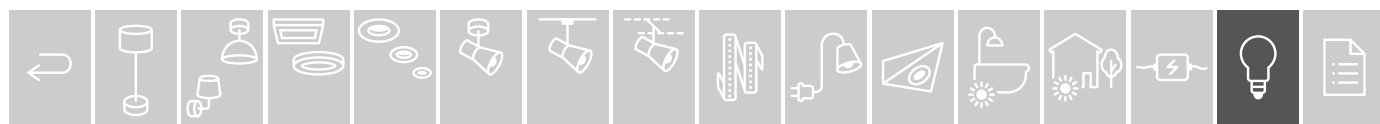

## Clear Transparente Trasparente



	W	⚡	∅ mm	⇅ mm	lm	♀	K	⌚	EAN	✔	
<b>A T G</b> <b>G</b>	3	E27	60	106	250		2.700	15.000	4000870 286142	✔	<b>286.14</b>
<b>A T G</b> <b>F</b>	4,3	E27	60	106	470		2.700	15.000	4000870 286951	✔	<b>286.95</b>
<b>A T G</b> <b>E</b>	7	E27	60	106	806		2.700	15.000	4000870 286968	✔	<b>286.96</b>
<b>A T G</b> <b>E</b>	9	E27	60	106	1.055		2.700	15.000	4000870 286197	✔	<b>286.19</b>
<b>A T G</b> <b>E</b>	11,5	E27	67	110	1.521		2.700	15.000	4000870 286975	✔	<b>286.97</b>



	W	⚡	∅ mm	⇅ mm	lm	♀	K	⌚	EAN	✔	
<b>A T G</b> <b>F</b>	2x5	E27	60	108	470		2.700	15.000	4000870 288566	✔	<b>new 288.56</b>
<b>A T G</b> <b>E</b>	2x7	E27	60	106	806		2.700	15.000	4000870 286418	✔	<b>286.41</b>



  
dimmable

	W	⚡	∅ mm	⇅ mm	lm	♀	K	⌚	EAN	✔	
<b>A T G</b> <b>F</b>	5	E27	60	106	470		2.700	15.000	4000870 286166	✔	<b>286.16</b>
<b>A T G</b> <b>F</b>	7,5	E27	60	106	806		2.700	15.000	4000870 286982	✔	<b>286.98</b>
<b>A T G</b> <b>E</b>	9	E27	60	106	1.055		2.700	15.000	4000870 286203	✔	<b>286.20</b>
<b>A T G</b> <b>E</b>	12,5	E27	70	126	1,521		2.700	20.000	4000870 286470	✔	<b>286.47</b>



  
3 step dim

## Clear Transparente Trasparente

	W	⚡	∅ mm	⇅ mm	lm	♀	K	⌚	EAN	✔	
<b>A T G</b> <b>F</b>	5	E27	60	104	470		2.700	15.000	4000870 285701	✔	<b>285.70</b>
<b>A T G</b> <b>F</b>	8	E27	60	104	806		2.700	15.000	4000870 285718	✔	<b>285.71</b>



  
dimmable

## Clear Transparente Trasparente

	W	⚡	∅ mm	⇅ mm	lm	♀	K	⌚	EAN	✔	
<b>A T G</b> <b>E</b>	15	E27	70	135	2.000		2.700	15.000	4000870 288177	✔	<b>new 288.17</b>



  
dim to warm

## Clear Transparente Trasparente

	W	⚡	∅ mm	⇅ mm	lm	♀	K	⌚	EAN	✔	
<b>A T G</b> <b>E</b>	7	E27	60	105	806		1.800 - 3.000	15.000	4000870 287767	✔	<b>287.76</b>



Matt Mate Opaco



	W	⊖	∅ mm	⇅ mm	lm	♀	K	⌚	EAN	✓	
<b>A</b> <b>G</b> <b>F</b>	3	E27	60	106	250		2.700	15.000	4000870 286159	✓	<b>286.15</b>
<b>A</b> <b>G</b> <b>F</b>	5	E27	60	106	470		2.700	15.000	4000870 286173	✓	<b>286.17</b>
<b>A</b> <b>G</b> <b>E</b>	7	E27	60	106	806		2.700	15.000	4000870 286180	✓	<b>286.18</b>
<b>A</b> <b>G</b> <b>E</b>	9	E27	60	106	1.055		2.700	15.000	4000870 286210	✓	<b>286.21</b>

	W	⊖	∅ mm	⇅ mm	lm	♀	K	⌚	EAN	✓	
<b>A</b> <b>G</b> <b>E</b>	2x7	E27	60	106	806		2.700	15.000	4000870 286425	✓	<b>286.42</b>

Matt Mate Opaco



	W	⊖	∅ mm	⇅ mm	lm	♀	K	⌚	EAN	✓		R, C
<b>A</b> <b>G</b> <b>F</b>	5,1	E27	60	106	470		2.700	15.000	4000870 286999	✓	<b>286.99</b>	
<b>A</b> <b>G</b> <b>F</b>	7,5	E27	60	106	806		2.700	15.000	4000870 287002	✓	<b>287.00</b>	
<b>A</b> <b>G</b> <b>E</b>	9	E27	60	106	1.055		2.700	15.000	4000870 286227	✓	<b>286.22</b>	

Matt Mate Opaco



	W	⊖	∅ mm	⇅ mm	lm	♀	K	⌚	EAN	✓		R, C
<b>A</b> <b>G</b> <b>F</b>	7,5	E27	60	106	806		4.000	15.000	4000870 287293	✓	<b>287.29</b>	
<b>A</b> <b>G</b> <b>E</b>	9	E27	60	106	1.055		4.000	15.000	4000870 288153	✓	<b>288.15</b>	

Matt Mate Opaco



	W	⊖	∅ mm	⇅ mm	lm	♀	K	⌚	EAN	✓		R, C
<b>A</b> <b>G</b> <b>F</b>	7,5	E27	60	106	806		6.500	15.000	4000870 287620	✓	<b>287.62</b>	
<b>A</b> <b>G</b> <b>E</b>	9	E27	60	106	1.055		6.500	15.000	4000870 288160	✓	<b>288.16</b>	





dim<sup>+</sup>  
dimmable

Clear Transparente Trasparente

	W	⊖	∅ mm	⇅ mm	lm	✂	K	⌚	EAN	☑	R, C
A T G F	7,5	E27	64	140	806		2.700	15.000	4000870 287033	✓	287.03



dim to warm

Clear Transparente Trasparente

	W	⊖	∅ mm	⇅ mm	lm	✂	K	⌚	EAN	☑	R, L, C
A T G E	7	E27	95	140	806		1.800 - 3.000	15.000	4000870 287798	✓	287.79



dim<sup>+</sup>  
dimmable

Opal Opal Opale

	W	⊖	∅ mm	⇅ mm	lm	✂	K	⌚	EAN	☑	R, C
A T G G	5,6	E27	80	120	470		2.700	15.000	4000870 286234	✓	286.23
A T G F	7,5	E27	80	118	806		2.700	15.000	4000870 287019	✓	287.01



dim<sup>+</sup>  
dimmable

	W	⊖	∅ mm	⇅ mm	lm	✂	K	⌚	EAN	☑	R, C
A T G G	5,6	E27	95	138	470		2.700	15.000	4000870 286241	✓	286.24
A T G F	7,5	E27	95	140	806		2.700	15.000	4000870 287026	✓	287.02
A T G E	9	E27	95	138	1.055		2.700	15.000	4000870 286258	✓	286.25



dim<sup>+</sup>  
dimmable

	W	⊖	∅ mm	⇅ mm	lm	✂	K	⌚	EAN	☑	R, C
A T G G	5,6	E27	125	173	470		2.700	15.000	4000870 286265	✓	286.26
A T G E	7	E27	125	173	806		2.700	15.000	4000870 286272	✓	286.27
A T G E	9	E27	125	173	1.055		2.700	15.000	4000870 286289	✓	286.28

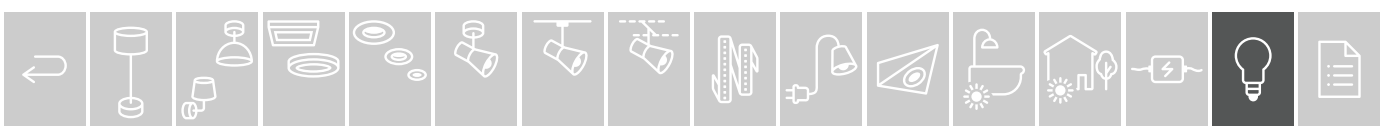



LED 1879 Edition

Gold Oro Oro



W	⚡	∅ mm	⇅ mm	lm	✂	K	⌚	EAN	☑	
2	E14	35	97	160		1.700	15.000	4000870 285244	☑	285.24

W	⚡	∅ mm	⇅ mm	lm	✂	K	⌚	EAN	☑	
2	E14	45	78	160		1.700	15.000	4000870 285251	☑	285.25

W	⚡	∅ mm	⇅ mm	lm	✂	K	⌚	EAN	☑	
6	E27	60	104	470		1.700	15.000	4000870 285220	☑	285.22

W	⚡	∅ mm	⇅ mm	lm	✂	K	⌚	EAN	☑	
2	E14	25	80	145		1.700	15.000	4000870 285268	☑	285.26

W	⚡	∅ mm	⇅ mm	lm	✂	K	⌚	EAN	☑	
8,5	E27	30	300	806		2.500	15.000	4000870 288313	☑	new 288.31

W	⚡	∅ mm	⇅ mm	lm	✂	K	⌚	EAN	☑	
2,7	E27	64	145	150		1.800	15.000	4000870 284063	☑	284.06

W	⚡	∅ mm	⇅ mm	lm	✂	K	⌚	EAN	☑	
4,4	E27	64	145	250		1.700	15.000	4000870 284070	☑	284.07

W	⚡	∅ mm	⇅ mm	lm	✂	K	⌚	EAN	☑	
6	E27	64	145	480		1.700	15.000	4000870 285237	☑	285.23

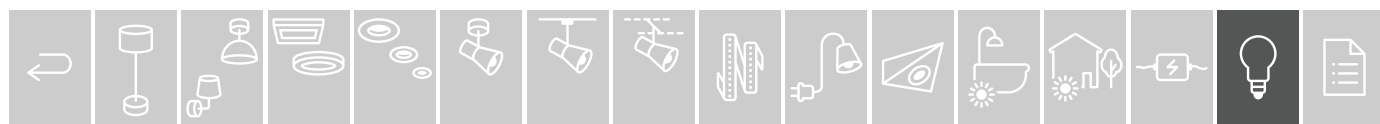



Gold Oro Oro

W	⚡	∅ mm	⇅ mm	lm	✂	K	⌚	EAN	📦	
2,7	E27	95	138	170		1.800	15.000	4000870 283998	✓	283.99
6,5	E27	95	138	400		1.700	15.000	4000870 284001	✓	284.00



dimmable

Gold Oro Oro

W	⚡	∅ mm	⇅ mm	lm	✂	K	⌚	EAN	📦	
6	E27	95	138	450		1.700	15.000	4000870 285213	✓	285.21



Gold Oro Oro

W	⚡	∅ mm	⇅ mm	lm	✂	K	⌚	EAN	📦	
2,7	E27	125	175	170		1.700	15.000	4000870 284018	✓	284.01
4,4	E27	125	175	250		1.700	15.000	4000870 284025	✓	284.02
6,5	E27	125	175	420		1.700	15.000	4000870 284032	✓	284.03



Gold Oro Oro

W	⚡	∅ mm	⇅ mm	lm	✂	K	⌚	EAN	📦	
4	E27	125	175	230		1.800	15.000	4000870 288696		new 288.69



dimmable

Gold Oro Oro

W	⚡	∅ mm	⇅ mm	lm	✂	K	⌚	EAN	📦	
7	E27	160	300	400		1.800	15.000	4000870 288672		new 288.67



dimmable

Gold Oro Oro

W	⚡	∅ mm	⇅ mm	lm	✂	K	⌚	EAN	📦	
7	E27	200	300	400		1.800	15.000	4000870 288689		new 288.68

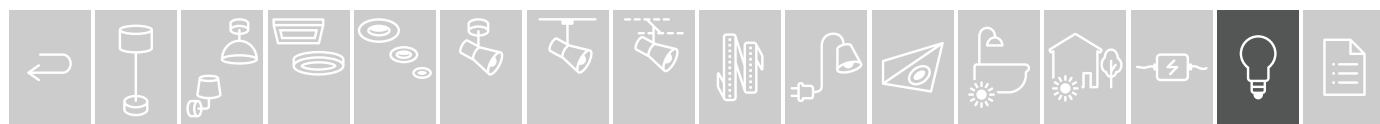



LED 1879 Edition

☞ Smoke glass Vidrio ahumado Vetro opaco



 dimmable

W	⚡	∅ mm	⇅ mm	lm	✂	K	⌚	EAN	☑	R, C
4	E14	35	98	145		1.800	15.000	4000870 288627	✓	new 288.62



 dimmable

W	⚡	∅ mm	⇅ mm	lm	✂	K	⌚	EAN	☑	R, C
4	E14	45	78	170		1.800	15.000	4000870 288634	✓	new 288.63



 dimmable

W	⚡	∅ mm	⇅ mm	lm	✂	K	⌚	EAN	☑	R, C
7,5	E27	60	106	350		1.800	15.000	4000870 288610	✓	new 288.61



 dimmable

W	⚡	∅ mm	⇅ mm	lm	✂	K	⌚	EAN	☑	R, C
4	E14	25	82	130		1.800	15.000	4000870 288665	✓	new 288.66

 dimmable



W	⚡	∅ mm	⇅ mm	lm	✂	K	⌚	EAN	☑	R, C
8,8	E27	30	300	806		2.700	15.000	4000870 288320	✓	new 288.32



 dimmable

W	⚡	∅ mm	⇅ mm	lm	✂	K	⌚	EAN	☑	R, C
7,5	E27	64	140	320		1.800	15.000	4000870 288641	✓	new 288.64







dimmable

Smoke glass Vidrio ahumado Vetro opaco

W	⚡	∅ mm	⇅ mm	lm	✂	K	⌚	EAN	📦	R.C.
8,0	E27	95	140	360		1.800	15.000	4000870 288658	✓	new 288.65



dimmable

Smoke glass Vidrio ahumado Vetro opaco

W	⚡	∅ mm	⇅ mm	lm	✂	K	⌚	EAN	📦	R.C.
4	E27	125	175	130		1.800	15.000	4000870 288603	✓	new 288.60



dimmable

Smoke glass Vidrio ahumado Vetro opaco

W	⚡	∅ mm	⇅ mm	lm	✂	K	⌚	EAN	📦	R.C.
7	E27	160	300	200		1.800	15.000	4000870 288580	✓	new 288.58



dimmable

Smoke glass Vidrio ahumado Vetro opaco

W	⚡	∅ mm	⇅ mm	lm	✂	K	⌚	EAN	📦	R.C.
7	E27	200	300	200		1.800	15.000	4000870 288597	✓	new 288.59





Edition  
Modern Classic



LED Decorative

🔗 Crown mirror silver Cúpula espejo plateado Testina a specchio argentato



A	B	G	W	⊖	∅ mm	⇅ mm	lm	⚡	K	⌚	EAN	✓	Price
			2,6		E14	45	78		2.700	15.000	4000870 286630	✓	286.63

🔗 Crown mirror silver Cúpula espejo plateado Testina a specchio argentato



🔘 dimmable

A	B	F	W	⊖	∅ mm	⇅ mm	lm	⚡	K	⌚	EAN	✓	Price
			4,8		E14	45	78		2.700	15.000	4000870 286678	✓	286.67

🔗 Crown mirror copper Cúpula espejo cobre Testina a specchio rame



A	B	G	W	⊖	∅ mm	⇅ mm	lm	⚡	K	⌚	EAN	✓	Price
			2,6		E14	45	78		2.700	15.000	4000870 286654	✓	286.65

🔗 Crown mirror silver Cúpula espejo plateado Testina a specchio argentato



A	B	G	W	⊖	∅ mm	⇅ mm	lm	⚡	K	⌚	EAN	✓	Price
			2,6		E27	45	72		2.700	15.000	4000870 286647	✓	286.64
			4,8		E27	45	72		2.700	15.000	4000870 286685	✓	286.68





🔗 Crown mirror silver Cúpula espejo plateado Testina a specchio argentato

	W	⚡	∅ mm	⇅ mm	lm	✂	K	🕒	EAN	📦	
<b>A</b> <b>E</b>	4,8	E27	60	106	580		2.700	15.000	4000870 286692	✓	<b>286.69</b>
<b>A</b> <b>F</b>	6,5	E27	60	106	600		2.700	15.000	4000870 286708	✓	<b>286.70</b>



🔗 Crown mirror copper Cúpula espejo cobre Testina a specchio rame

	W	⚡	∅ mm	⇅ mm	lm	✂	K	🕒	EAN	📦	
<b>A</b> <b>F</b>	6,5	E27	60	106	600		2.700	15.000	4000870 286715	✓	<b>286.71</b>



🔗 Crown mirror silver Cúpula espejo plateado Testina a specchio argentato

	W	⚡	∅ mm	⇅ mm	lm	✂	K	🕒	EAN	📦	
<b>A</b> <b>E</b>	4,8	E27	95	138	580		2.700	15.000	4000870 286722	✓	<b>286.72</b>



 dimmable

🔗 Crown mirror silver Cúpula espejo plateado Testina a specchio argentato

	W	⚡	∅ mm	⇅ mm	lm	✂	K	🕒	EAN	📦	
<b>A</b> <b>F</b>	6,5	E27	95	138	600		2.700	15.000	4000870 286739	✓	<b>286.73</b>

 R.C.



🔗 Crown mirror copper Cúpula espejo cobre Testina a specchio rame

	W	⚡	∅ mm	⇅ mm	lm	✂	K	🕒	EAN	📦	
<b>A</b> <b>F</b>	6,5	E27	95	138	600		2.700	15.000	4000870 286746	✓	<b>286.74</b>

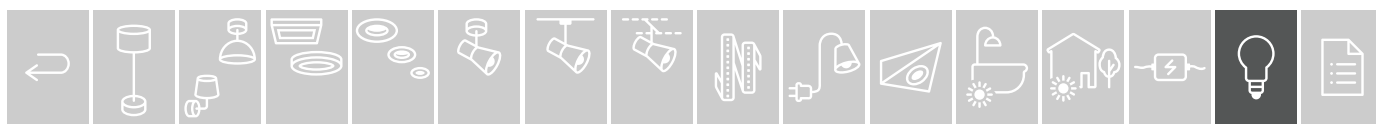



Crown mirror gold Cúpula espejo oro Testina a specchio dorato

dimmable

W	⊖	∅ mm	⇅ mm	lm	⚡	K	⌚	EAN	✓	R, C
6,5	E27	95	138	600		2.700	15.000	4000870 286753	✓	286.75



Crown mirror black matt Cúpula espejo negro mate Testina a specchio nero opaco

dimmable

W	⊖	∅ mm	⇅ mm	lm	⚡	K	⌚	EAN	✓	R, C
6,5	E27	95	138	600		2.700	15.000	4000870 286760	✓	286.76



Crown mirror black chrome Cúpula espejo negro cromo Testina a specchio cromo nero

dimmable

W	⊖	∅ mm	⇅ mm	lm	⚡	K	⌚	EAN	✓	R, C
6,5	E27	95	138	600		2.700	15.000	4000870 286777	✓	286.77



Crown mirror gold Cúpula espejo oro Testina a specchio dorato

dimmable

W	⊖	∅ mm	⇅ mm	lm	⚡	K	⌚	EAN	✓	R, C
6,5	E27	125	174	600		2.700	15.000	4000870 286784	✓	286.78

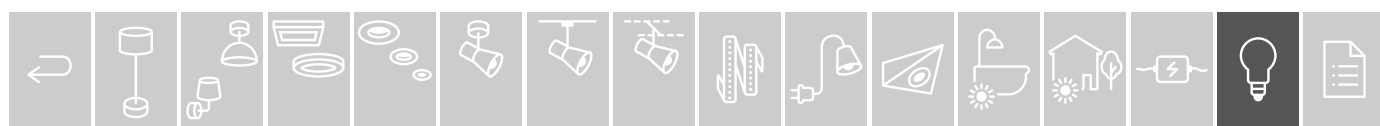



🔗 Crown mirror black matt Cúpula espejo negro mate Testina a specchio nero opaco

 dimmable

W	⚡	∅ mm	⇅ mm	lm	✂	K	⌚	EAN	📦	R, C
<b>6,5</b>	E27	125	174	600		2.700	15.000	4000870 286791	✓	<b>286.79</b>



🔗 Crown mirror black chrome Cúpula espejo negro cromo Testina a specchio cromo nero

 dimmable

W	⚡	∅ mm	⇅ mm	lm	✂	K	⌚	EAN	📦	R, C
<b>6,5</b>	E27	125	174	600		2.700	15.000	4000870 286807	✓	<b>286.80</b>



🔗 Ring mirror silver Espejo anular plateado Specchio ad anello argentato

 dimmable

W	⚡	∅ mm	⇅ mm	lm	✂	K	⌚	EAN	📦	R, C
<b>6,5</b>	E27	125	174	640		2.700	15.000	4000870 286814	✓	<b>286.81</b>



🔗 Ring mirror black matt Espejo anular negro mate Specchio ad anello nero opaco

 dimmable

W	⚡	∅ mm	⇅ mm	lm	✂	K	⌚	EAN	📦	R, C
<b>6,5</b>	E27	125	174	640		2.700	15.000	4000870 286821	✓	<b>286.82</b>

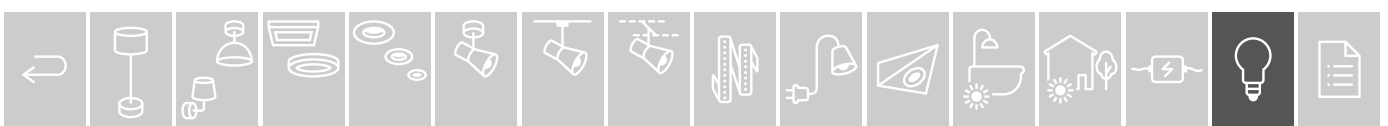



 dimmable

 Ring mirror black Espejo anular oro Specchio ad anello dorato

W	⊖	∅ mm	⇅ mm	lm	⚡	K	⌚	EAN	✓	R, C
 <b>4,5</b>	E27	125	170	420		2.500	15.000	4000870 287705	✓	<b>287.70</b>

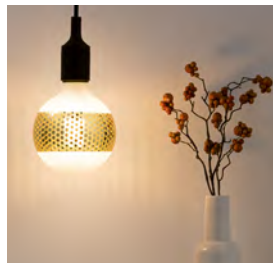

 dimmable

 Ring mirror silver Espejo anular plateado Specchio ad anello argentato

W	⊖	∅ mm	⇅ mm	lm	⚡	K	⌚	EAN	✓	R, C
 <b>4,5</b>	E27	125	170	420		2.600	15.000	4000870 287422	✓	<b>287.42</b>

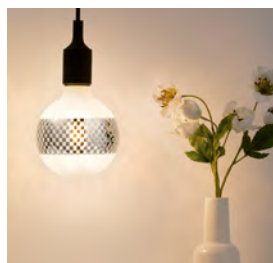

 dimmable

 Ring mirror white Espejo anular negro Specchio ad anello nero

W	⊖	∅ mm	⇅ mm	lm	⚡	K	⌚	EAN	✓	R, C
 <b>4,5</b>	E27	125	170	340		2.600	15.000	4000870 287439	✓	<b>287.43</b>



 dimmable

 height adjustable Espejo anular blanco Specchio ad anello bianco

W	⊖	∅ mm	⇅ mm	lm	⚡	K	⌚	EAN	✓	R, C
 <b>4,5</b>	E27	125	170	470		2.600	15.000	4000870 287446	✓	<b>287.44</b>

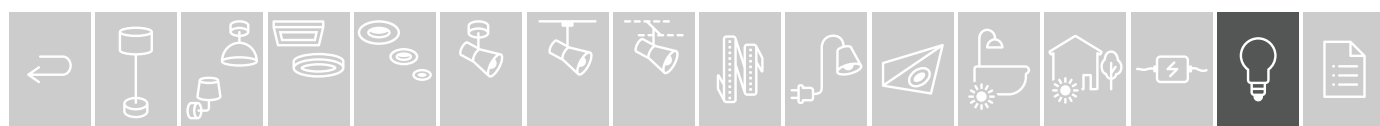
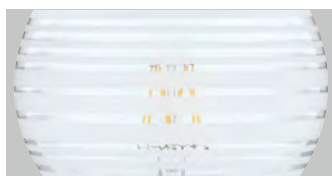



## Edition Inner Shape



Matt Mate Opaco

	W	⊖	∅ mm	⇅ mm	lm	✂	K	⌚	EAN	☑	R, C
<b>A B G E</b>	4	E27	95	150	450		2.700	15.000	4000870 287682	✓	<b>287.68</b>

Matt Mate Opaco

	W	⊖	∅ mm	⇅ mm	lm	✂	K	⌚	EAN	☑	R, C
<b>A B G F</b>	4	E27	125	187	400		2.700	15.000	4000870 287644	✓	<b>287.64</b>



Gold Oro Oro

	W	⊖	∅ mm	⇅ mm	lm	✂	K	⌚	EAN	☑	R, C
<b>A B G F</b>	4	E27	95	150	400		2.700	15.000	4000870 287699	✓	<b>287.69</b>

Gold Oro Oro

	W	⊖	∅ mm	⇅ mm	lm	✂	K	⌚	EAN	☑	R, C
<b>A B G F</b>	4	E27	125	187	400		2.700	15.000	4000870 287651	✓	<b>287.65</b>



Smoke glass Vidrio ahumado Vetro opaco

	W	⊖	∅ mm	⇅ mm	lm	✂	K	⌚	EAN	☑	R, C
<b>A B G G</b>	4	E27	95	150	270		2.700	15.000	4000870 287668	✓	<b>287.66</b>

Smoke glass Vidrio ahumado Vetro opaco

	W	⊖	∅ mm	⇅ mm	lm	✂	K	⌚	EAN	☑	R, C
<b>A B G G</b>	4	E27	125	187	300		2.700	15.000	4000870 287637	✓	<b>287.63</b>





### Inner Glow

Inner Glow – Completely glare-free gold glass lamps with inner corn cob bulb add extra-warm lighting accents to any living room. Available in three designs with two different laser-engraved patterns.

### Inner Glow

Inner Glow – Las lámparas totalmente antideslumbrantes de vidrio dorado con ampolla interior crean tonos luminosos especialmente cálidos en cada estancia. Disponibles en tres formas con dos diferentes dibujos grabados al láser.

### Inner Glow

Inner Glow – Lampadine in vetro a fondo d'oro con ampolle interne, creano accenti luminosi caldi in ogni ambiente. Disponibili in tre forme costruttive, con due diversi pattern di incisione laser.



Gold Oro Oro



W	⚡	∅ mm	∩ mm	Lm	⚡	K	⌚	EAN	✓	
4	E27	64	145	200		1.800	15.000	4000870 285985	✓	285.98

Gold Oro Oro



W	⚡	∅ mm	∩ mm	Lm	⚡	K	⌚	EAN	✓	
4	E27	64	145	200		1.800	15.000	4000870 285992	✓	285.99







dimmable

Gold Oro Oro



W	⊖	∅ mm	⇅ mm	lm	✂	K	⌚	EAN	☑	new
3,6	E27	64	142	120		1.800	15.000	4000870 288290	✓	288.29



dimmable

Gold Oro Oro



W	⊖	∅ mm	⇅ mm	lm	✂	K	⌚	EAN	☑	new
3,6	E27	64	142	120		1.800	15.000	4000870 288306	✓	288.30



Gold Oro Oro



W	⊖	∅ mm	⇅ mm	lm	✂	K	⌚	EAN	☑	
4	E27	75	165	200		1.800	15.000	4000870 286005	✓	286.00

Gold Oro Oro



W	⊖	∅ mm	⇅ mm	lm	✂	K	⌚	EAN	☑	
4	E27	75	165	200		1.800	15.000	4000870 286012	✓	286.01



dimmable

Gold Oro Oro



W	⊖	∅ mm	⇅ mm	lm	✂	K	⌚	EAN	☑	new
3,6	E27	75	162	120		1.800	15.000	4000870 288276	✓	288.27

Gold Oro Oro



W	⊖	∅ mm	⇅ mm	lm	✂	K	⌚	EAN	☑	new
3,6	E27	75	162	120		1.800	15.000	4000870 288283	✓	288.28

dimmable



Gold Oro Oro



W	⊖	∅ mm	⇅ mm	lm	✂	K	⌚	EAN	☑	
4	E27	95	145	200		1.800	15.000	4000870 286029	✓	286.02

Gold Oro Oro



W	⊖	∅ mm	⇅ mm	lm	✂	K	⌚	EAN	☑	
4	E27	95	145	200		1.800	15.000	4000870 286036	✓	286.03





White/Silver Blanco/Plateado Bianco/Argento



W	⊖	∅ mm	⇅ mm	lm	⚡	K	⌚	EAN	✓	new
4,9	GU5,3	100	58	440		3.000	15.000	4000870 288023	✓	288.02

7 VA

White Blanco Bianco



W	⊖	∅ mm	⇅ mm	lm	⚡	K	⌚	EAN	✓	new
4,9	GU5,3	100	58	440		3.000	15.000	4000870 288030	✓	288.03

7 VA

Black/Gold Negro/Oro Nero/Oro



W	⊖	∅ mm	⇅ mm	lm	⚡	K	⌚	EAN	✓	new
4,9	GU5,3	100	58	170		1.900	15.000	4000870 288047	✓	288.04

7 VA

Black/White Negro/Blanco Nero/Bianco



W	⊖	∅ mm	⇅ mm	lm	⚡	K	⌚	EAN	✓	new
4,9	GU5,3	100	58	440		3.000	15.000	4000870 288054	✓	288.05

7 VA

Silver/White Plateado/Blanco Argento/Bianco



W	⊖	∅ mm	⇅ mm	lm	⚡	K	⌚	EAN	✓	3 step dim
4,9	GU10	100	66	360		3.000	15.000	4000870 287927	✓	287.92

White Blanco Bianco



W	⊖	∅ mm	⇅ mm	lm	⚡	K	⌚	EAN	✓	3 step dim
4,9	GU10	100	66	360		3.000	15.000	4000870 287934	✓	287.93

Black/Gold Negro/Oro Nero/Oro



W	⊖	∅ mm	⇅ mm	lm	⚡	K	⌚	EAN	✓	3 step dim
4,9	GU10	100	66	170	55	1.900	15.000	4000870 287941	✓	287.94

Black/White Negro/Blanco Nero/Bianco



W	⊖	∅ mm	⇅ mm	lm	⚡	K	⌚	EAN	✓	3 step dim
4,9	GU10	100	66	360		3.000	15.000	4000870 287958	✓	287.95



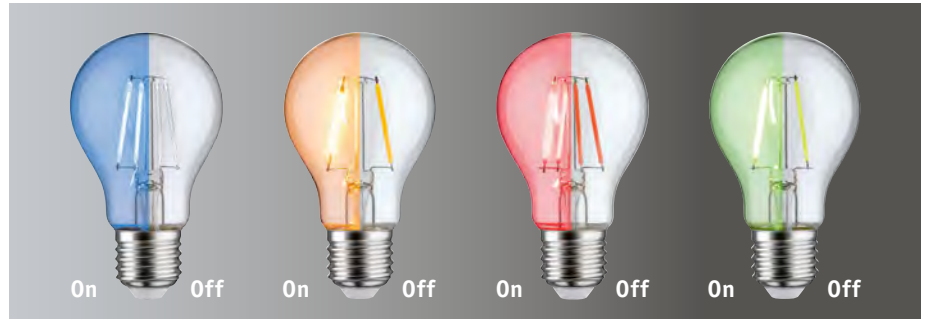

Clear Transparente Trasparente

W	⚡	∅ mm	⇅ mm	lm	⚡	K	⌚	EAN	☑	DECO
2,2	E27	60	106	40		1.000	15.000	4000870 287217	✓	287.21



Clear Transparente Trasparente

W	⚡	∅ mm	⇅ mm	lm	⚡	K	⌚	EAN	☑	DECO
1,3	E27	60	106	40		1.000	15.000	4000870 287231	✓	287.23



Clear Transparente Trasparente

W	⚡	∅ mm	⇅ mm	lm	⚡	K	⌚	EAN	☑	DECO
1,1	E27	60	106	170		4.900	15.000	4000870 287248	✓	287.24



Clear Transparente Trasparente

W	⚡	∅ mm	⇅ mm	lm	⚡	K	⌚	EAN	☑	DECO
1,1	E27	60	106	100		2.000	15.000	4000870 287224	✓	287.22





*Edition*  
Vintage



Gold Oro Oro

	W	⊖	∅ mm	⇅ mm	lm	✂	K	⊕	EAN	✓	
<b>A</b> <b>G</b> <b>F</b>	2,6	E14	35	98	260		2.500	15.000	4000870 287040	✓	<b>287.04</b>



 dimmable

	W	⊖	∅ mm	⇅ mm	lm	✂	K	⊕	EAN	✓	
<b>A</b> <b>G</b> <b>F</b>	4,7	E14	35	98	430		2.500	15.000	4000870 287057	✓	<b>287.05</b>

R, C



Clear Transparente Trasparente

	W	⊖	∅ mm	⇅ mm	lm	✂	K	⊕	EAN	✓	
<b>A</b> <b>G</b> <b>F</b>	2,6	E14	35	98	280		2.700	15.000	4000870 287064	✓	<b>287.06</b>



 dimmable

	W	⊖	∅ mm	⇅ mm	lm	✂	K	⊕	EAN	✓	
<b>A</b> <b>G</b> <b>F</b>	4,7	E14	35	98	450		2.700	15.000	4000870 287071	✓	<b>287.07</b>

R, C



Gold Oro Oro

	W	⊖	∅ mm	⇅ mm	lm	✂	K	⊕	EAN	✓	
<b>A</b> <b>G</b> <b>F</b>	2,6	E14	35	98	260		2.500	15.000	4000870 287088	✓	<b>287.08</b>



 dimmable

	W	⊖	∅ mm	⇅ mm	lm	✂	K	⊕	EAN	✓	
<b>A</b> <b>G</b> <b>F</b>	4,7	E14	35	98	430		2.500	15.000	4000870 287095	✓	<b>287.09</b>

R, C





Gold Oro Oro

ATG	F	W	⊖	∅ mm	⇅ mm	lm	✂	K	⊕	EAN	✓	
		2,6	E14	45	78	260		2.500	15.000	4000870 287118	✓	287.11



dimmable

ATG	F	W	⊖	∅ mm	⇅ mm	lm	✂	K	⊕	EAN	✓	
		4,7	E14	45	78	430		2.500	15.000	4000870 287125	✓	287.12

R, C



Gold Oro Oro

ATG	F	W	⊖	∅ mm	⇅ mm	lm	✂	K	⊕	EAN	✓	
		2,6	E27	45	72	260		2.500	15.000	4000870 287101	✓	287.10



dimmable

ATG	F	W	⊖	∅ mm	⇅ mm	lm	✂	K	⊕	EAN	✓	
		4,7	E27	45	72	430		2.500	15.000	4000870 287132	✓	287.13

R, C



Gold Oro Oro

ATG	F	W	⊖	∅ mm	⇅ mm	lm	✂	K	⊕	EAN	✓	
		4,7	E27	60	106	500		2.500	15.000	4000870 287149	✓	287.14

ATG	F	W	⊖	∅ mm	⇅ mm	lm	✂	K	⊕	EAN	✓	
		6,5	E27	60	106	680		2.500	15.000	4000870 287156	✓	287.15



Gold Oro Oro

ATG	F	W	⊖	∅ mm	⇅ mm	lm	✂	K	⊕	EAN	✓	
		6,5	E27	95	138	680		2.500	15.000	4000870 287163	✓	287.16



Gold Oro Oro

ATG	F	W	⊖	∅ mm	⇅ mm	lm	✂	K	⊕	EAN	✓	
		6,5	E27	64	140	680		2.500	15.000	4000870 287170	✓	287.17

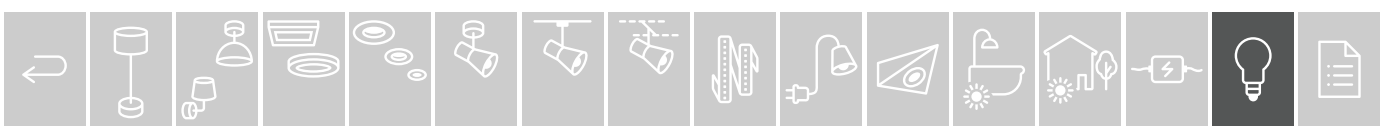



Edition  
Miracle Mosaic

LED lamp  
inside 5W  
E14  
2700K  
470lm  
E27



off on

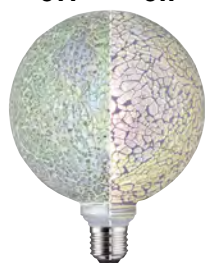

White Blanco Bianco

dimmable

W	⚡	∅ mm	⇅ mm	Lm	⚡	K	⌚	EAN	✓	R. C.
5	E27	130	170	470		2.700	15.000	4000870 287453	✓	287.45

off on



Black Negro Nero

dimmable

W	⚡	∅ mm	⇅ mm	Lm	⚡	K	⌚	EAN	✓	R. C.
5	E27	130	170	470		2.700	15.000	4000870 287460	✓	287.46

off on

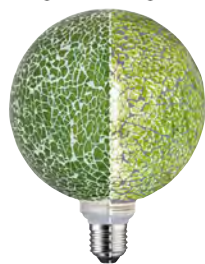

Green Verde Verde

dimmable

W	⚡	∅ mm	⇅ mm	Lm	⚡	K	⌚	EAN	✓	R. C.
5	E27	130	170	470		2.700	15.000	4000870 287477	✓	287.47

off on



Blue Azul Blu

dimmable

W	⚡	∅ mm	⇅ mm	Lm	⚡	K	⌚	EAN	✓	R. C.
5	E27	130	170	470		2.700	15.000	4000870 287507	✓	287.50

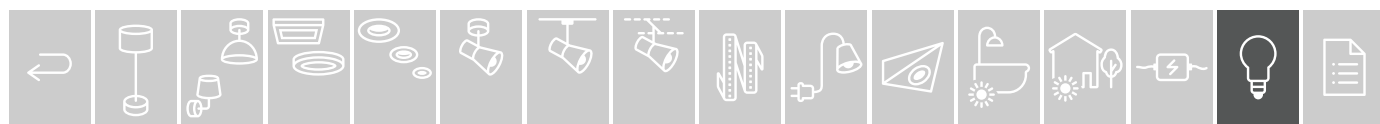



LED lamp  
inside 5W  
E14  
2700K  
470lm  
E27



Dichroic Dicroico Dicroico

dimming icon

W	⊖	∅ mm	↑ mm	lm	⚡	K	⌚	EAN	✓	R, C
5	E27	75	140	470		2.700	15.000	4000870 287712	✓	287.71



Dichroic Dicroico Dicroico

dimming icon

W	⊖	∅ mm	↑ mm	lm	⚡	K	⌚	EAN	✓	R, C
5	E27	75	165	470		2.700	15.000	4000870 287729	✓	287.72



Dichroic Dicroico Dicroico

dimming icon

W	⊖	∅ mm	↑ mm	lm	⚡	K	⌚	EAN	✓	R, C
5	E27	95	145	470		2.700	15.000	4000870 287736	✓	287.73



Dichroic Dicroico Dicroico

dimming icon

W	⊖	∅ mm	↑ mm	lm	⚡	K	⌚	EAN	✓	R, C
5	E27	125	165	470		2.700	15.000	4000870 287743	✓	287.74



LED Smart Home

All-glass filament lamps

lámparas de filamento y ampolla de vidrio

Lampade a filamento e vetro

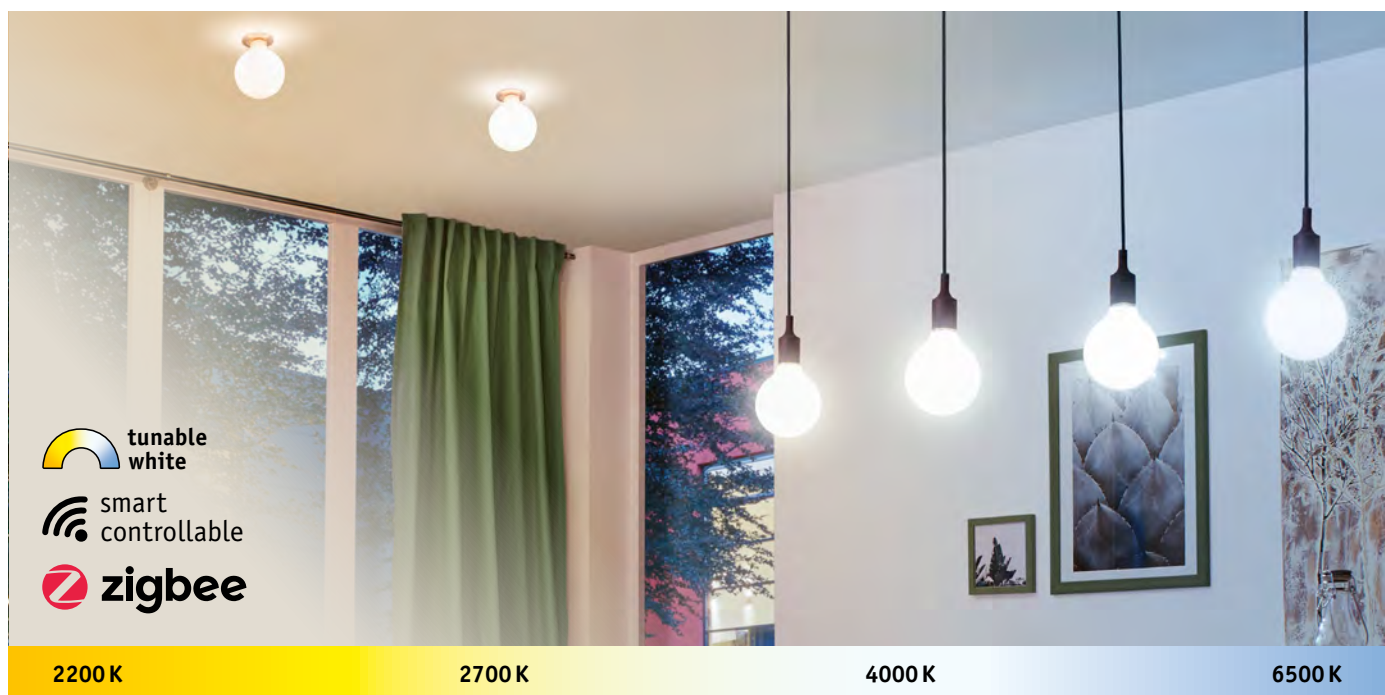

tunable white  
smart controllable  
zigbee

2200 K

2700 K

4000 K

6500 K



tunable white

Matt Mate Opaco

	W	⊖	∅ mm	⇅ mm	lm	✂	K	⌚	EAN	📶	📶	📶
<b>A</b> <b>F</b>	4,7	E27	60	105	470		2.200 - 6.500	15.000	4000870 503911	📶	📶	📶
<b>A</b> <b>E</b>	7	E27	60	105	806		2.200 - 6.500	15.000	4000870 503928	📶	📶	📶



tunable white

Clear Transparente Trasparente

	W	⊖	∅ mm	⇅ mm	lm	✂	K	⌚	EAN	📶	📶	📶
<b>A</b> <b>F</b>	4,7	E27	60	105	470		2.200 - 6.500	15.000	4000870 503935	📶	📶	📶
<b>A</b> <b>E</b>	7	E27	60	105	806		2.200 - 6.500	15.000	4000870 503942	📶	📶	📶



tunable white

Clear Transparente Trasparente

	W	⊖	∅ mm	⇅ mm	lm	✂	K	⌚	EAN	📶	📶	📶
<b>A</b> <b>E</b>	7	E27	64	140	806		2.200 - 6.500	15.000	4000870 503959	📶	📶	📶



tunable white

Opal Opal Opale

	W	⊖	∅ mm	⇅ mm	lm	✂	K	⌚	EAN	📶	📶	📶
<b>A</b> <b>E</b>	7	E27	95	134	806		2.200 - 6.500	15.000	4000870 503966	📶	📶	📶

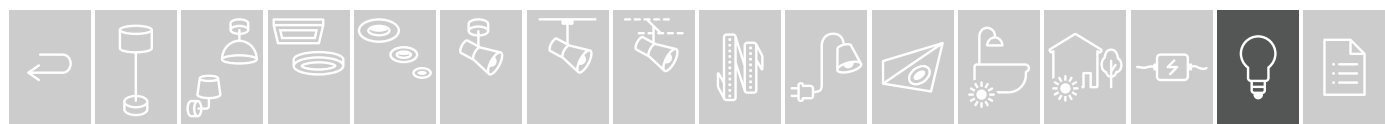



## LED Smart Home

Plastic

Plástico

Plastica



dimmable

Matt Mate Opaco

W	⊖	∅ mm	⇅ mm	lm	✂	K	⌚	EAN	📶	📶
9	E27	60	118	820		2.700	15.000	4000870 501221	✓	501.22



tunable white

Matt Mate Opaco

W	⊖	∅ mm	⇅ mm	lm	✂	K	⌚	EAN	📶	📶
9	E27	60	118	820		2.700 - 6.500	15.000	4000870 501238	✓	501.23



RGBW

Matt Mate Opaco

W	⊖	∅ mm	⇅ mm	lm	✂	K	⌚	EAN	📶	📶
9,3	E27	60	118	806		2.700 - 6.500	15.000	4000870 501245	✓	501.24



dimmable

Matt Mate Opaco

W	⊖	∅ mm	⇅ mm	lm	✂	K	⌚	EAN	📶	📶
5	E14	38	105	400		2.700	15.000	4000870 501252	✓	501.25



tunable white

Matt Mate Opaco

W	⊖	∅ mm	⇅ mm	lm	✂	K	⌚	EAN	📶	📶
5	E14	38	105	400		2.700 - 6.500	15.000	4000870 501269	✓	501.26



RGBW

Matt Mate Opaco

W	⊖	∅ mm	⇅ mm	lm	✂	K	⌚	EAN	📶	📶
6,3	E14	38	105	470		2.700 - 6.500	15.000	4000870 501276	✓	501.27



dimmable

Matt Mate Opaco

W	⊖	∅ mm	⇅ mm	lm	✂	K	⌚	EAN	📶	📶
5	GU10	50	54	330	36	2.700	15.000	4000870 501283	✓	501.28



tunable white

Matt Mate Opaco

W	⊖	∅ mm	⇅ mm	lm	✂	K	⌚	EAN	📶	📶
5	GU10	50	54	330	36	2.700 - 6.500	15.000	4000870 501290	✓	501.29



RGBW

Matt Mate Opaco

W	⊖	∅ mm	⇅ mm	lm	✂	K	⌚	EAN	📶	📶
5,5	GU10	50	54	350	36	2.700 - 6.500	15.000	4000870 501306	✓	501.30

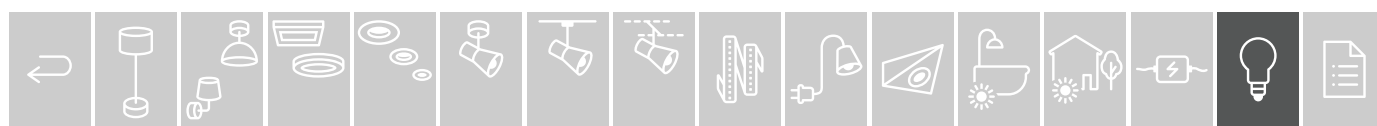

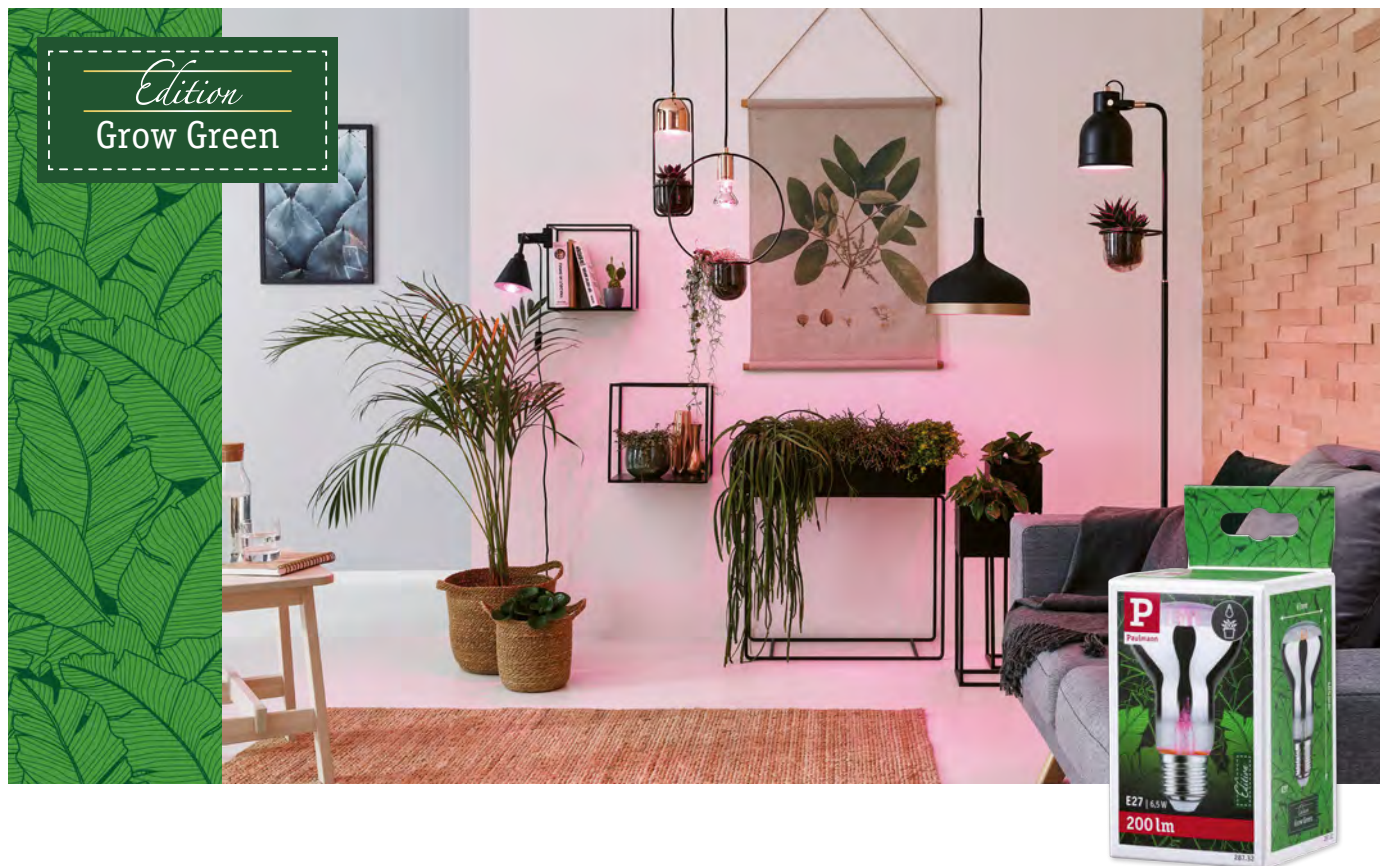

Edition  
Grow Green

Grow light Luz de crecimiento Luce per piante



W	⊖	∅ mm	⇅ mm	lm	✂	K	⊕	EAN	☑	DECO
3,5	GU10	50	54	65	115	1.100	15.000	4000870 287361	✓	287.36



R50

W	⊖	∅ mm	⇅ mm	lm	✂	K	⊕	EAN	☑	DECO
4	E14	50	85	100	64	1.300	15.000	4000870 287347	✓	287.34



R63

W	⊖	∅ mm	⇅ mm	lm	✂	K	⊕	EAN	☑	DECO
6,5	E27	63	105	200	106	1.300	15.000	4000870 287323	✓	287.32



R80

W	⊖	∅ mm	⇅ mm	lm	✂	K	⊕	EAN	☑	DECO
6,5	E27	80	116	200	60	1.300	15.000	4000870 287330	✓	287.33



PAR38

W	⊖	∅ mm	⇅ mm	lm	✂	K	⊕	EAN	☑	DECO
6,5	E27	120	148	200	115	1.300	15.000	4000870 287378	✓	287.37



## Energy Saver / Tube fluorescent



Opal Opal Opale



T5

	W	⚡	∅ mm	⚗ mm	lm	color	K	⌚	EAN	☑	
	22	2GX13	16	223	1.850	827	2.700	12.000	4000870 884485	✓	<b>884.48</b>
	55	2GX13	16	298	4.200	827	2.700	12.000	4000870 884461	✓	<b>884.46</b>



T5

Opal Opal Opale



	W	⚡	∅ mm	⚗ mm	lm	color	K	⌚	EAN	☑	
	8	G5	16	301	480	830	3.000	5.000	4000870 885086	✓	<b>885.08</b>
	13	G5	16	530	950	830	3.000	5.000	4000870 885130	✓	<b>885.13</b>
	W	⚡	∅ mm	⚗ mm	lm /360°	color	K	⌚	EAN	☑	
	8	G5	16	301	440	840	4.000	5.000	4000870 885604	✓	<b>885.60</b>
	13	G5	16	530	950	840	4.000	5.000	4000870 885611	✓	<b>885.61</b>
	14	G5	16	560	1.205	840	4.000	10.000	4000870 885635	✓	<b>885.63</b>
	21	G5	16	864	1.890	840	4.000	10.000	4000870 885628	✓	<b>885.62</b>



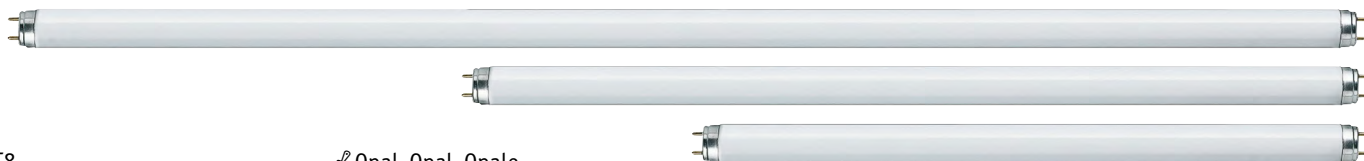

T8

Opal Opal Opale

	W	⚡	∅ mm	⚓ mm	lm	color	K	⌚	EAN	✓	
	15	G13	26	451	963	827	2.700	8.000	4000870 885154	✓	<b>885.15</b>
	18	G13	26	604	1,350	827	2.700	8.000	4000870 885215	✓	<b>885.21</b>
	30	G13	26	910	2,400	827	2.700	8.000	4000870 885451	✓	<b>885.45</b>
	36	G13	26	1.214	3,348	827	2.700	8.000	4000870 885499	✓	<b>885.49</b>
	58	G13	26	1.515	5,220	827	2.700	8.000	4000870 885536	✓	<b>885.53</b>

	W	⚡	∅ mm	⚓ mm	lm	color	K	⌚	EAN	✓	
	18	G13	26	604	1,350	840	4.000	8.000	4000870 885413	✓	<b>885.41</b>
	36	G13	26	1.214	3,348	840	4.000	8.000	4000870 885505	✓	<b>885.50</b>
	58	G13	26	1.515	5,167	840	4.000	8.000	4000870 885543	✓	<b>885.54</b>

	W	⚡	∅ mm	⚓ mm	lm	color	K	⌚	EAN	✓	
	18	G13	26	604	1,215	865	6.500	8.000	4000870 885192	✓	<b>885.19</b>
	36	G13	26	1.214	3,013	865	6.500	8.000	4000870 885369	✓	<b>885.36</b>
	58	G13	26	1.515	4,698	865	6.500	8.000	4000870 885581	✓	<b>885.58</b>

White Plastic  
 Blanco Plástico  
 Bianco Plastica



**Starter Universal**  
 max. 4-65 W  
 ⚓39 ∅20 mm  
 EAN 4000870 884843  
**884.84**



**Starter Tandem/Duo**  
 max. 2x4-22 W  
 ⚓39 ∅20 mm  
 EAN 4000870 884249  
**884.24**

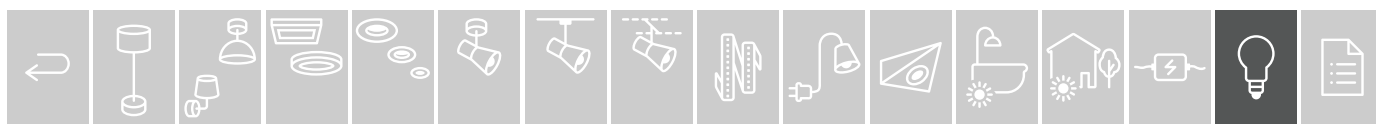

## Halogen 12V

Clear Transparente Trasparente



	W	⚡	∅ mm	⇅ mm	lm	↘	K	⌚	EAN	☑	
<b>G</b>	<b>2x11</b>	G4	9	33	135		2.900	2.000	4000870 831496	✓	<b>new 831.49</b>
<b>G</b>	<b>2x22</b>	G4	9	33	340		2.900	2.000	4000870 831526	✓	<b>new 831.52</b>
<b>G</b>	<b>2x38</b>	G4	9	33	690		2.900	2.000	4000870 831557	✓	<b>new 831.55</b>



	W	⚡	∅ mm	⇅ mm	lm	↘	K	⌚	EAN	☑	
<b>G</b>	<b>2x22</b>	GY6,35	10	38	340		2.900	2.000	4000870 831519	✓	<b>new 831.51</b>
<b>G</b>	<b>2x38</b>	GY6,35	10	38	690		2.900	2.000	4000870 831533	✓	<b>new 831.53</b>
<b>G</b>	<b>2x54</b>	GY6,35	10	38	1.070		2.900	2.000	4000870 831540	✓	<b>new 831.54</b>

## Halogen 230V

Clear Transparente Trasparente



	W	⚡	∅ mm	⇅ mm	lm	↘	K	⌚	EAN	☑	
<b>G</b>	<b>2x22</b>	G9	13	42	212		2.700	2.000	4000870 800874	✓	<b>new 800.87</b>
<b>G</b>	<b>2x35</b>	G9	13	42	416		2.800	2.000	4000870 800881	✓	<b>new 800.88</b>
<b>G</b>	<b>2x45</b>	G9	13	42	575		2.800	2.000	4000870 800898	✓	<b>new 800.89</b>
<b>G</b>	<b>2x75</b>	G9	13	42	1.070		2.800	2.000	4000870 800904	✓	<b>new 800.90</b>
<b>G</b>	<b>2x56</b>	G9	13	42	750		2.800	2.000	4000870 800911	✓	<b>new 800.91</b>

## 230V B22D-G9 / B15d-G9 / E27-GU10

Minihalogen base  
Casquillo Minihalogen  
Base Minihalogen



White Blanco Bianco

W	⚡	∅ mm	⇅ mm	lm	↘	K	⌚	EAN	☑	
<b>max. 75</b>	G9 / B22d	28	50					4000870 549278	✓	<b>549.27</b>

Minihalogen base  
Casquillo Minihalogen  
Base Minihalogen



White Blanco Bianco

W	⚡	∅ mm	⇅ mm	lm	↘	K	⌚	EAN	☑	
<b>max. 75</b>	G9 / B15d	25	50					4000870 549285	✓	<b>549.28</b>

E27-GU10 base  
Casquillo E27-GU10  
Base E27-GU10

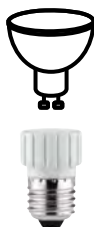

White Blanco Bianco

W	⚡	∅ mm	⇅ mm	lm	↘	K	⌚	EAN	☑	
<b>max. 50</b>	GU10 / E27	35	53					4000870 549292	✓	<b>549.29</b>





## Conventional Lamps

### Clear Transparente Trasparente



W	⚡	∅ mm	⇅ mm	lm	♀	K	⌚	EAN	📦	
7	E14	25	60	43		2.300	1.000	4000870 800157		<b>800.15</b>

### Red Rojo Rosso



W	⚡	∅ mm	⇅ mm	lm	♀	K	⌚	EAN	📦	DECO
15	E14	25	60	26			1.000	4000870 800119		<b>800.11</b>

### Yellow Amarillo Giallo



W	⚡	∅ mm	⇅ mm	lm	♀	K	⌚	EAN	📦	DECO
15	E14	25	60	83			1.000	4000870 800126		<b>800.12</b>

### Matt Mate Interno opaco



W	⚡	∅ mm	⇅ mm	lm	♀	K	⌚	EAN	📦	
8	E27	45	70	40		2.300	1.000	4000870 128084		<b>128.08</b>



W	⚡	∅ mm	⇅ mm	lm	♀	K	⌚	EAN	📦	
8	E14	45	78	40		2.300	1.000	4000870 127087		<b>127.08</b>

### Matt Mate Interno opaco



W	⚡	∅ mm	⇅ mm	lm	♀	K	⌚	EAN	📦	
8	E27	35	95	40		2.300	1.000	4000870 444085		<b>444.08</b>



W	⚡	∅ mm	⇅ mm	lm	♀	K	⌚	EAN	📦	
8	E14	35	97	40		2.300	1.000	4000870 449080		<b>449.08</b>





Clear Transparente Trasparente



W	⊖	∅ mm	⇅ mm	lm	↗	K	⌚	EAN	📦
3	E27	35	95	1			1.000	4000870 531006	531.00

W	⊖	∅ mm	⇅ mm	lm	↗	K	⌚	EAN	📦
3	E14	35	97	1			1.000	4000870 530009	530.00

W	⊖	∅ mm	⇅ mm	lm	↗	K	⌚	EAN	📦
3	E14	35	130	1			1.000	4000870 530030	530.03



Black light Luz negra Luce nera



W	⊖	∅ mm	⇅ mm	lm	↗	K	⌚	EAN	📦
75	E27	55	95				1.000	4000870 590706	590.70

- |  |  |  |
|--|--|--|
| ▶ Infrared   | ▶ Infrarrojo   | ▶ Infrarosso   |
| ▶ Not suitable for medical applications.                     | ▶ No apto para aplicaciones médicas.                                   | ▶ Non per uso medico.  |
| ▶ Approved for use in luminaires with protective glass only. | ▶ Solo se permite su uso en luminarias con cristal de protección.      | ▶ Solo per apparecchi con vetro protettivo.                              |
| ▶ Not for general lighting, only for special applications!   | ▶ No apto para iluminación general, solo para aplicaciones especiales! | ▶ Non adatto all'illuminazione generale, solo per applicazioni speciali! |



R80 Infrared

R95 Infrared

Red Rojo Rosso



W	⊖	∅ mm	⇅ mm	lm	↗	K	⌚	EAN	📦
60	E27	80	115	26	80	1.500	1.000	4000870 829776	829.77

W	⊖	∅ mm	⇅ mm	lm	↗	K	⌚	EAN	📦
100	E27	95	134	64	80	1.500	1.000	4000870 829660	829.66

300° Clear 300° Claro Trasparenza 300°



W	⊖	∅ mm	⇅ mm	lm	↗	K	⌚	EAN	📦
15	E14	22	50	85		2.300	1.000	4000870 820100	820.10

W	⊖	∅ mm	⇅ mm	lm	↗	K	⌚	EAN	📦
25	E14	25	55	125		2.200	1.000	4000870 820117	820.11



## How bright is the lamp?

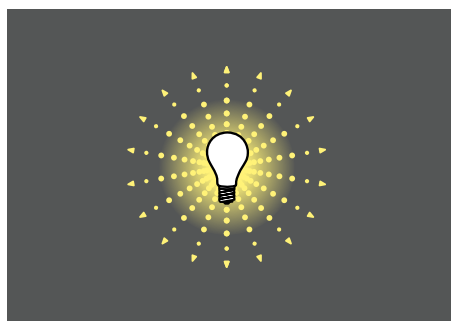

### Brightness with omnidirectional spotlights

**The unit of measurement lumen (lm)** is specified with luminous flux the total amount of light that an omnidirectional lamp emits.

## ¿Cómo de luminosa es la lámpara?

### Luminosidad de proyectores omnidireccionales

**La unidad lumen (lm)** de flujo luminoso indica la cantidad total de luz que emite una lámpara que irradie en todas direcciones.

## Quanto è luminosa la lampadina?

### Luminosità con luci omnidirezionali

**L'unità di misura lumen (lm)** e il flusso luminoso indicano la quantità complessiva di luce emanata da una lampadina.

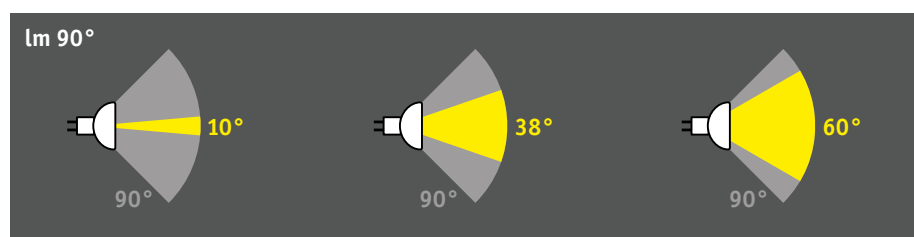

### Brightness with reflector lamps

All reflector lamps with a beam angle of up to 90° are prescribed with luminous flux in a 90° angle and can therefore be compared. The brightness is measured outside of the 90° angle even though the actual beam angle is lesser.

All reflector lamps with a beam angle of 91° to up to 120° are prescribed with luminous flux in a 120° angle. These bulbs are not suitable for accent lighting.

All bulbs with a beam angle greater than 120° are considered „non-directional light“ and are prescribed with the luminous flux value (lumen, lm) that is determined in the complete 360° around the bulb.

The various units of measurement lumen (lm), lumen in the 90° angle (lm90°) and lumen in the 120° angle (lm120°) cannot be compared with each other.

### Luminosidad de lámparas reflectoras

Para posibilitar su comparación, en todas las lámparas reflectoras con un ángulo de irradiación de hasta 90° se indica el flujo luminoso en un ángulo de 90°. Se mide la luminosidad dentro del ángulo de 90°, aunque el ángulo de irradiación real sea menor.

En todas las lámparas reflectoras con un ángulo de irradiación de 91° hasta 120° se indica el flujo luminoso en un ángulo de 120°. Este tipo de luminaria no es adecuado para una iluminación de acentuación.

Todas las luminarias con un ángulo de irradiación mayor de 120° se consideran como „luz no dirigida“ y en ellas se indica el valor del flujo luminoso (lumen, lm) irradiado en todas direcciones (360°) alrededor de la luminaria.

Las diversas unidades de medida, lumen (lm), lumen en un ángulo de 90° (lm90°) y lumen en un ángulo de 120° (lm120°), no son comparables entre sí.

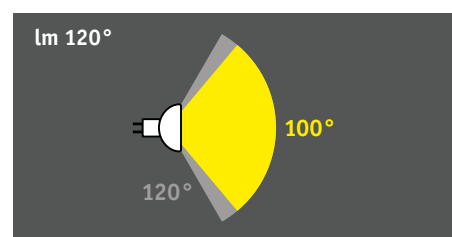

### Luminosità con riflettori

Tutti i riflettori con un angolo di irradiazione fino a max. 90° vengono contrassegnati con flusso luminoso a 90° e sono quindi comparabili tra loro. La luminosità viene misurata all'interno dell'angolo di 90°, anche se l'angolo di irradiazione effettivo è minore.

Tutti i riflettori con un angolo di irradiazione compreso tra 91° e max. 120° vengono contrassegnati con il valore di flusso luminoso a 120°. I corpi luminosi di questo tipo non sono adatti per l'illuminazione di accento.

Tutti i corpi luminosi con un angolo di irradiazione superiore a 120° sono considerati „luci non mirate“ e vengono contrassegnati con il valore di flusso luminoso (lumen, lm) calcolato su tutti i 360° intorno al corpo luminoso.

Le diverse unità di misura lumen (lm), lumen a 90° (lm90°) e lumen a 120° (lm120°) non sono comparabili tra loro.

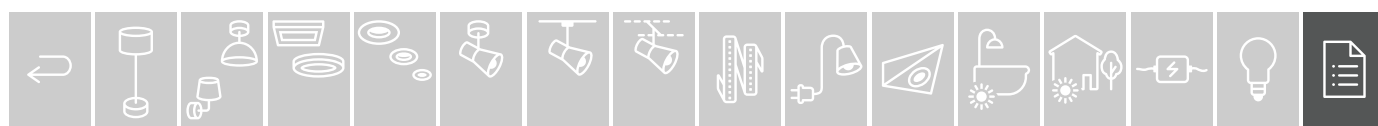







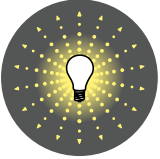

Lumen comparison

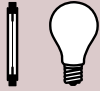
Comparativa de lúmenes

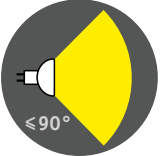
Comparazione luminosità

	Lighting technology Luminotecnia Soluzione illuminotecnica		(Incandescent) lamp watts Lámpara (incandescente) vatios Lampadina (a incandescenza) Watt	LED brightness in lumen Luminosidad LED en lúmenes Luminosità LED in Lumen
<p>Omnidirectional lamps Proyectores omnidireccionales Luci omnidirezionali</p> 	<p>Classic incandescent light bulb Lámpara incandescente clásica Lampadina a incandescenza classica <b>E14, E27, GU10</b></p> 		15 W	140 lm
			25 W	250 lm
			40 W	470 lm
			60 W	806 lm
			75 W	1055 lm
			100 W	1521 lm
	<p>Halogen 230V <b>G9, E27, R7s</b></p> 		25 W	250 lm
			40 W	470 lm
			60 W	806 lm
	<p>Halogen 12V <b>G4, GY6,35</b></p> 		5 W	45 lm
			10 W	90 lm
			20 W	190 lm
			35 W	390 lm
			50 W	630 lm
	<p>Reflector lamps Lámparas con reflector Riflettori</p> 	<p>Halogen 230V <b>E14, E27, GU10</b></p> 		25 W
			35 W	200 lm
			50 W	300 lm
<p>Halogen 12V <b>GU4, GU5,3</b></p> 			10 W	80 lm / 90 lm (GU4 / GU5,3)
			20 W	160 lm / 180 lm (GU4 / GU5,3)
			35 W	300 lm
			50 W	540 lm

LED instead of halogen – replacing high-voltage lamps (230 V):

1. Select the desired design.
2. Find your socket type.
3. Should the lamp be dimmable?
4. Select the desired brightness (watts/lumen). Please pay attention to the minimum transformer load.
5. Which luminous colour should the lamp have?

LED en lugar de halógeno – sustitución en lámparas de alto voltaje (230 V):

1. ¡Seleccione el diseño que desee!
2. ¡Busque su casquillo!
3. ¿La lámpara debe ser regulable?
4. Seleccione la claridad deseada (vatios/lumen). Tenga en cuenta la carga mínima en transformadores.
5. ¿Qué color de luz debe tener su lámpara?

LED al posto delle alogene - sostituzione della lampadine ad alto voltaggio (230 V):

1. Selezionate la forma desiderata!
2. Individuate l'attacco giusto!
3. La luce deve essere regolabile?
4. Selezionate la luminosità desiderata (watt/lumen). Considerate il carico minimo dei trasformatori.
5. Quale deve essere il colore della luce della lampadina?





**Dimmable**  
Continuously variable dimming without changing the light colour.\*

**Dimmable**  
Regulación continua sin cambiar la tonalidad de la luz.\*

**Dimmable**  
Dimming in continuo senza modificare il colore della luce.\*



**Dim to warm**  
From bright warm white to dimmed gold light: Continuously variable dimming with simultaneous change of the colour temperature.\*

**Dim to warm**  
Del luminoso blanco cálido al tenue dorado: regulación continua con cambio simultáneo de la temperatura de color.\*

**Dim to warm**  
Dal colore bianco caldo luminoso alla luce oro in modalità di regolazione: Dimming in continuo con modifica contemporanea della temperatura di colore.\*

\*Please read our article descriptions on [www.paulmann.com](http://www.paulmann.com) to help choose the right dimmer for your purposes

\* A la hora de elegir el regulador, observe nuestras notas sobre los artículos en nuestra página web [www.paulmann.com](http://www.paulmann.com)

\*Per la selezione del dimmer tenere conto delle nostre avvertenze relative agli articoli sul nostro sito web [www.paulmann.com](http://www.paulmann.com)

Dimming via conventional wall switch without separate dimmer

Regulación mediante interruptor de pared convencional sin regulador separado

Dimming tramite interruttore a parete convenzionale senza dimmer separato

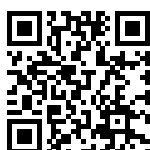

**3 Step dim**  
Dimming in three steps via repeated actuation of the existing commercial light switch.

**3 Step dim**  
Regulación en 3 niveles con un accionamiento repetido del interruptor de luz corriente existente.

**3 Step dim**  
Intensità regolabile in 3 livelli mediante azionamenti multipli dal normale interruttore presente.



**Easydim**  
A quick On/Off of the existing commercial light switch indicates the start and stop of the infinite dimming process.

**Easydim**  
Una breve operación de apagado y encendido con el interruptor de luz corriente existente inicia y detiene la regulación continua.

**Easydim**  
L'accensione e lo spegnimento breve con il normale interruttore presente avvia e arresta il processo continuo di dimming.



**3 Step dim to warm**  
From bright warm white to dimmed gold light: Dimming and simultaneous colour temperature change in three steps via repeated actuation of the existing commercial light switch.

**3 Step dim to warm**  
Del luminoso blanco cálido al tenue dorado: regulación en tres niveles y cambio simultáneo de la temperatura de color con un accionamiento repetido del interruptor de luz corriente existente.

**3 Step dim to warm**  
Dal colore bianco caldo luminoso alla luce oro in modalità di regolazione: intensità regolabile in tre livelli e modifica contemporanea della temperatura di colore mediante azionamenti multipli del normale interruttore presente.

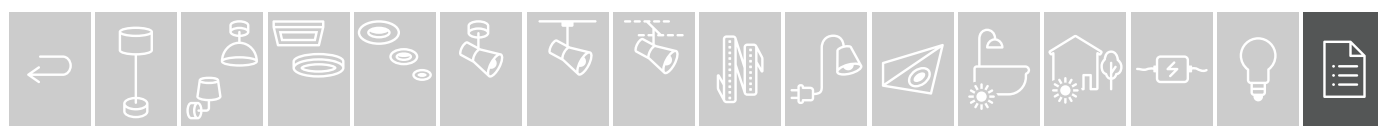

## What light colour?

¿Qué tonalidad de la luz desea?

Che colore vorreste per la vostra luce?



**Extra warm white light** or gold light has a reddish hue and appears like candle light. Super cosy!

**Luz de color blanco extracálido** o luz dorada es rojiza, similar a la luz de las velas, y crea un ambiente extremadamente acogedor.

**Luce extra bianca calda** o luce oro rossastra, ha lo stesso effetto della luce di una candela ed è molto confortevole!

**extra warm white**  
1500–2700 K

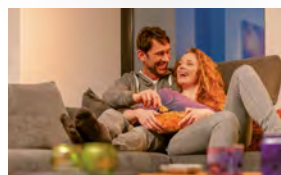

**Warm white light** closely resembles natural light at sunset and has a relaxing effect on the psyche.

**Luz de color blanco cálido** es similar a la luz natural durante la puesta del sol y tiene un efecto relajante.

**Luce bianca calda** è simile alla luce naturale al tramonto e ha un effetto rilassante su di noi.

**warm white**  
2700–3300 K



**Neutral white light** "matter of fact" lighting – perfect for the kitchen or bathroom.

**Luz de color blanco neutro** crea una iluminación «sobria»; muy apropiada para la cocina y el cuarto de baño.

**Luce bianco neutrale** produce un'illuminazione piuttosto "funzionale", adatta alla cucina o al bagno.

**neutral white**  
3300–5300 K

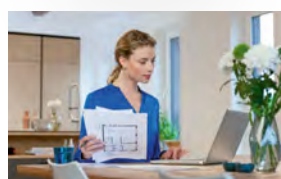

**Daylight white light** closely resembles natural light at midday. Light with a high blue ratio is stimulating and promotes concentration. Perfect for the illumination of work areas

**Luz de color blanco diurno** equivale a la luz diurna al mediodía. Esta luz, con un mayor componente de azul, tiene un efecto estimulante y favorece la concentración. Ideal para la iluminación de áreas de trabajo.

**Luce bianca diurna** corrisponde alla luce di mezzogiorno. La luce con una percentuale più elevata di blu ha un effetto energizzante e stimola la concentrazione. Ideale per l'illuminazione delle aree di lavoro

**daylight**  
≥ 5300 K



**Tunable white:** Infinite adjustment of the white light colour and brightness in the range between warm white and daylight white.

**Blanco ajustable:** Selección sin escalonados de la tonalidad de la luz blanca en un rango entre blanco cálido y blanco diurno.

**Tunable White:** Selezione in continuo del colore della luce bianco e della luminosità nell'area da bianco caldo a bianco naturale.



**White switch:** Selection of three white tones (warm white, neutral white or daylight white) with repeated pushes of the existing commercial light switch.

**White switch:** Elección entre tres tonos de blanco (blanco cálido, neutro o diurno) con un accionamiento repetido del interruptor de luz corriente existente.

**White switch:** Selezione fra tre tonalità di bianco (bianco caldo, bianco neutrale o bianco naturale) mediante azionamenti multipli dell'interruttore presente.

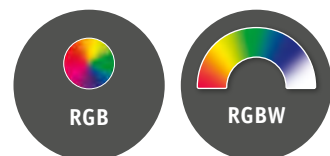

**RGB:** Infinitely variable selection of 16 million colours

**RGB:** Selección continua entre 16 millones de tonos de luz.

**RGB:** Selezione continua fra 16 milioni di tonalità di colore,

**RGBW:** Stepless dimming with the addition of true warm white.

**RGBW:** Adicionalmente con blanco cálido auténtico, regulable sin escalonados.

**RGBW:** anche con bianco caldo reale, dimmerabile in continuo.



**RGB Rainbow:** Dynamic lighting effects in rainbow colours

**RGB Rainbow:** Efectos lumínicos dinámicos con los colores del arco iris

**RGB Rainbow:** Effetti luminosi dinamici nei colori dell'arcobaleno

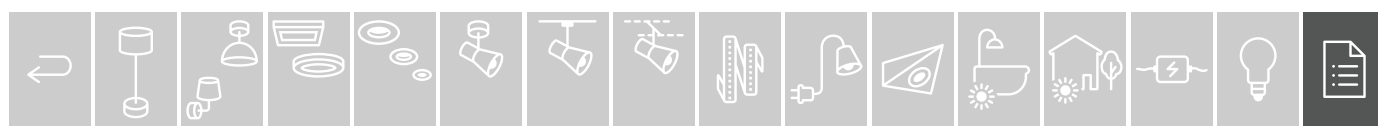

LED instead of halogen – replacing low-voltage lamps (12V):

LED en lugar de halógeno – sustitución en lámparas de bajo voltaje (12 V):

LED al posto delle alogene - sostituzione della lampadine a basso voltaggio (12V):

<p><b>1</b></p> <p>Which transformer does my system have? ¿Qué transformador tiene mi sistema? Qual è il trasformatore del mio sistema?</p>	<p><b>2</b></p> <p>Will LED and halogen lights be used mixed together? ¿Pueden emplearse lámparas LED y halógenas mezcladas? Devono essere utilizzate lampadine LED e alogene combinate?</p>	<p><b>3</b></p> <p>Determine the capacity range (VA) of the transformer and exchange the lamps. Averigüe el rango de utilización (VA) del transformador y cambie las lámparas. Definire il range di carico (VA) del trasformatore e sostituire le lampadine.</p>
---	--	--

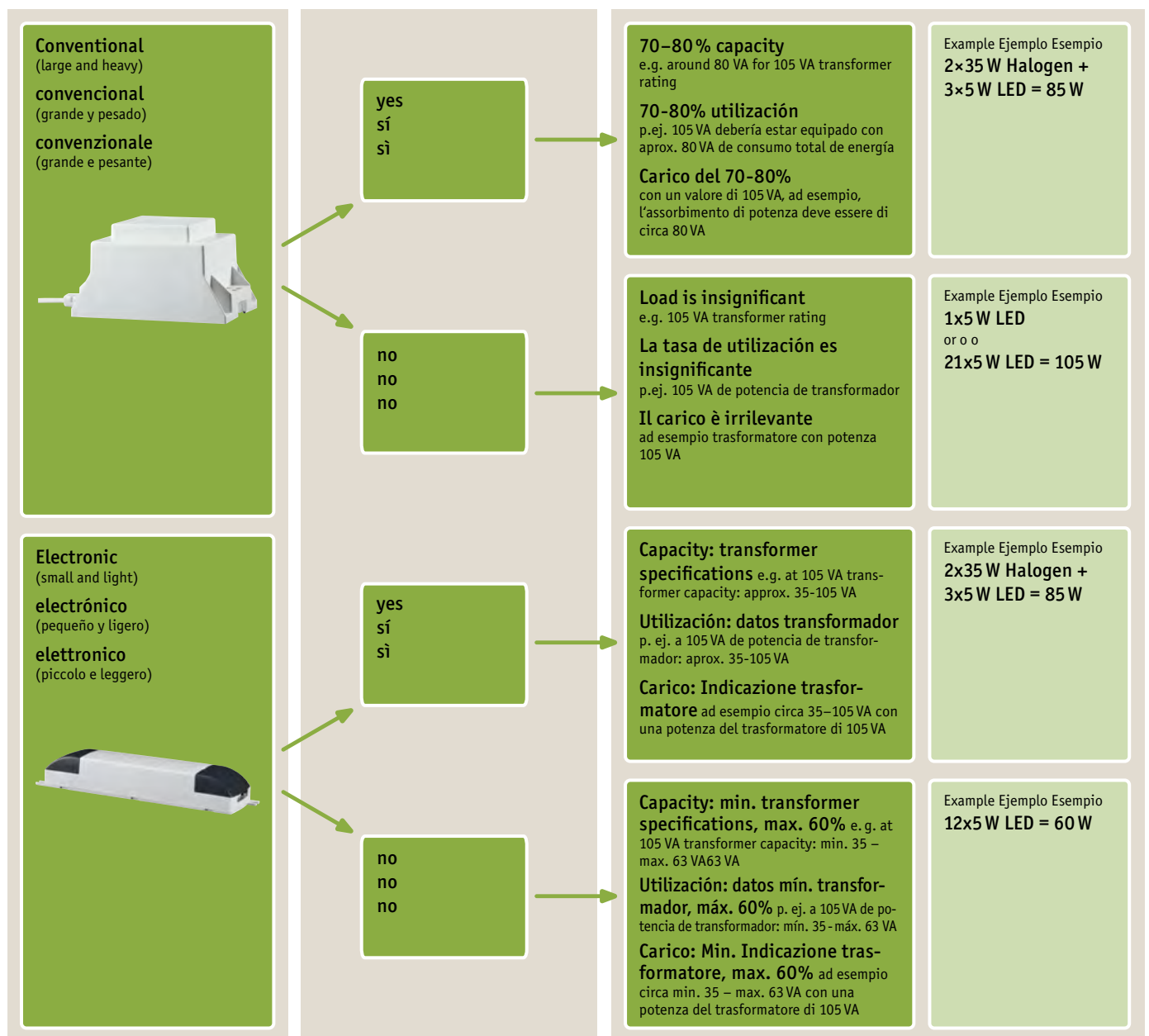

The value of 1 VA (Volt-ampere) in the transformer rating corresponds to the value of 1 W (watt) in the rated power consumption of the lamps.

El valor de 1 VA (voltamperios) en la norma de potencia de transformadores corresponde a 1W (vatio) de consumo de energía de las lámparas.

Il valore di 1 VA (voltampere) nell'indicazione della potenza del trasformatore corrisponde a 1 W (watt) di potenza assorbita delle lampadine.



### Transformer for LED: the universal solution

If the new LED lamps do not meet the minimum transformer load, we recommend a new electronic transformer which consumes power of 0-40 watts (with LED). Item no. 977.67

### Transformador para LED: la solución universal

Si los nuevos LED no alcanzan la carga mínima del transformador, le recomendamos un nuevo transformador eléctrico, que acepte potencia de 0-40 vatios (con LED) Art. n° 977.67

### Trasformatore per LED: la soluzione universale

Se le nuove lampadine LED non raggiungono il carico minimo del trasformatore, si consiglia l'utilizzo di un nuovo trasformatore elettronico che assorbe la potenza di 0-40 watt (con i LED). Codice: 977.67



### Dimmer identification

Luminaires that are supplied without lamps and, where applicable, without ballast are marked "max. 40W", for example. If these luminaires are dimmable, they are marked with

However, dimmability depends on the type of lamp used and, where applicable, the ballast. More detailed information can be found here: [www.paulmann.com/productdata](http://www.paulmann.com/productdata)

When installing a luminaire you have to find the right dimmer for the right lamp.

The letters (**R, L, C, LED...**) or combinations of those letters indicate the types of dimmers, transformers and lamps.

When choosing a dimmer, the letters on the dimmer must correspond to those on the transformer or the lamp.

LED products require an LED dimmer which can be either a LEADING-edge



or a TRAILING-edge



dimmer.  
(Letters **LED, HV-LED, LEDi**)

### Identificación del regulador

Las luminarias que se suministran sin lámpara y, en su caso, sin balasto, están identificadas p. ej. con «máx. 40 W». En caso de que estas luminarias sean regulables, están identificadas con

Sin embargo, la regulación depende del tipo de lámpara empleada y, en su caso, del balasto. Puede encontrar más información aquí: [www.paulmann.com/productdata](http://www.paulmann.com/productdata)

En la instalación se debe combinar el regulador correcto con la lámpara/luminaria correcta.

Los distintivos (**R, L, C, LED...**) o sus combinaciones definen los reguladores, los transformadores y las lámparas.

Para elegir el regulador correcto, los respectivos distintivos del regulador, el transformador o la lámpara deberán coincidir.

Para los productos LED, necesita un regulador LED de corte de inicio de fase



o bien de corte de final de fase



(distintivos **LED, HV-LED, LEDi**)

### Marcatura dimmer

Gli apparecchi forniti senza lampadina ed eventualmente senza alimentatore sono dichiarati con ad es. "max. 40W". Se sono dimmerabili, sono dichiarati con

La regolazione dell'intensità dipende tuttavia dal tipo di lampadina utilizzata ed eventualmente dall'alimentatore. Qui trovate ulteriori informazioni: [www.paulmann.com/productdata](http://www.paulmann.com/productdata)

In un'installazione, il dimmer deve essere adatto alla lampadina / luce.

I codici (**R, L, C, LED...**) o le relative combinazioni definiscono dimmer, trasformatori e lampade.

Per la scelta del dimmer più adatto, i codici presenti sul dimmer, sul trasformatore o sulla lampada devono coincidere.

Per le lampade a LED è necessario un dimmer LED ad anticipo di fase







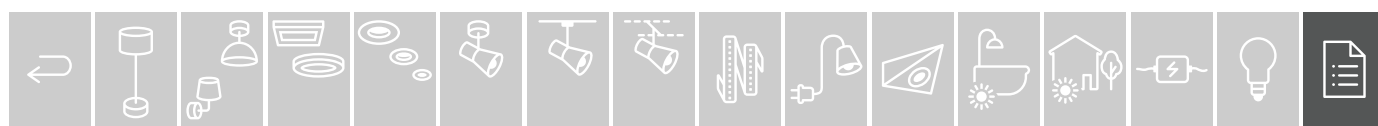

o a ritardo di fase



(Codice **LED, HV-LED, LEDi**)





 <b>IP68</b>	Waterproof during permanent immersion (* and 12 V/24 V low voltage protector)	Protección contra inmersión permanente (* y 12 V/24 V tensión baja de protección máx.)	Protezione dall'immersione di lunga durata (* e 12 V/24 V bassissima tensione di protezione)
 <b>IP67</b>	Water proof during temporary immersion (* and 12 V/24 V low voltage protector)	Resistente al agua en caso de inmersión temporánea (* y 12 V/24 V tensión baja de protección máx.)	Impermeabile all'immersione temporanea (* e 12 V/24 V bassissima tensione di protezione)
 <b>IP65</b>	Water jet protected against direct water jets (* and 12 V/24 V low voltage protector)	Resistente al agua proyectada en caso de chorro directo (* y 12 V/24 V tensión baja de protección máx.)	Protezione dai getti diretti d'acqua (* e 12 V/24 V bassissima tensione di protezione)
 <b>IP44</b>	Splash protected	Resistente a salpicaduras de agua	Protezione dagli spruzzi d'acqua
 <b>IP23</b>	Spray protected	Resistente al agua atomizada	Protezione da acqua nebulizzata
 <b>IP...</b>	Safety classification IP only applies to ceiling fittings.	La clase de protección IP sólo es válida en las instalaciones en el techo.	Il grado di protezione IP è valido solo per il montaggio a soffitto.

**Rooms with electrical systems acc. to DIN VDE 0100 T.701 (areas valid for ceilings up to 2.25 m)**

Only luminaires that are covered by a permanently attached glass plate may be installed in the ceiling or where the operation is low voltage protector.

The safety power source has to be outside the marked areas and there needs to be protection against direct contact of live parts. Cable and lines up to 5 cm deep in wall: only vertical layout and cable inlet in the back side of the luminaire.

**Countries outside Germany:** The dimensions, which must be adhered to exactly, as well as the evaluation of the areas must be conducted by a local electrician in accordance with national installation regulations.

**Interiores con equipos eléctricos según DIN VDE 0100 T.701 (margen válido de hasta 2,25 m de altura)**

En el techo podrán empotrarse únicamente lámparas que estén cubiertas por una luna fija o que funcionen con baja tensión de protección.

La fuente de corriente de seguridad deberá hallarse fuera de la zona marcada y estar protegida contra el contacto directo de componentes conductores de tensión. Cables y conducciones hasta 5 cm bajo el enlucido: solamente tendido en vertical e introducción de cable en la cara trasera de la lámpara.

**Países fuera de Alemania:** Las medidas exactas que hay que observar, así como la evaluación de las zonas deberá efectuarse en conformidad con las normativas de instalación nacionales y por un electricista local.

**Locali con impianti elettrici a norma DIN VDE 0100 T.701 (zone con un'altezza massima di 2,25 m)**

Gli apparecchi d'illuminazione possono essere incassati nel soffitto solo se sono coperti da una lastra di vetro fissa, oppure se sono alimentati con bassissima tensione.

La fonte della corrente di sicurezza deve essere disposta al di fuori delle zone contrassegnate e deve essere presente una protezione che impedisca il contatto diretto con i componenti attraversati dalla corrente. Cavi e conduttori fino a 5 cm sotto l'intonaco: solo posa verticale e inserimento del cavo nel lato posteriore dell'apparecchio d'illuminazione.

**Paesi diversi dalla Germania:** Le misure esatte da rispettare come anche la valutazione degli ambienti devono essere eseguite da un elettricista del luogo in conformità alle norme nazionali di installazione.

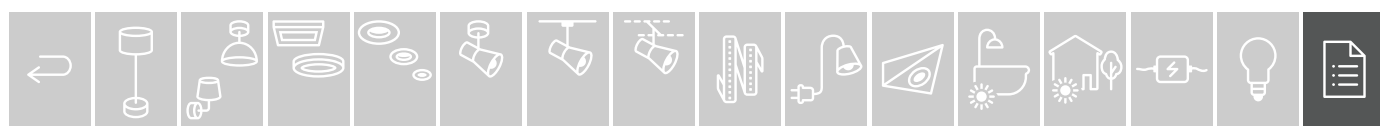





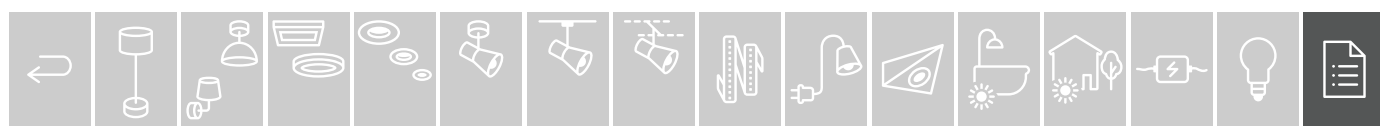

	☐		☐
Detector de movimientos . . . . .	237, 391	Forno . . . . .	437
Deviatore . . . . .	210	Frame . . . . .	145
Dilja . . . . .	24	Fridge . . . . .	403
Dimmer . . . . .	183	Frigorifero . . . . .	403
Disc . . . . .	197	Frigorífico . . . . .	403
Distribuidor . . . . .	342	Galeria . . . . .	287
Distribution device . . . . .	342	Garden Spot . . . . .	363
Distributore . . . . .	342	Gesa . . . . .	273
Diversor . . . . .	210	Globe . . . . .	293
Diverter . . . . .	210	Globo . . . . .	293
Duo Profil . . . . .	253	Ground spike . . . . .	330, 377
Edge . . . . .	140	Gutta . . . . .	54
Edla . . . . .	27	Halo+ . . . . .	435
Elia . . . . .	27	Horno de cocer . . . . .	437
Encendedor . . . . .	434	House number . . . . .	375
Esben . . . . .	25	Iben . . . . .	27
Espejo anular . . . . .	419	Infrared lamp . . . . .	437
Estaca . . . . .	330, 377	Infrared . . . . .	437
Faretti da incasso a pavimento .325, 327–328, 331–332, 334, 358–360, 381		Infrarosso . . . . .	437
Feed . . . . .	180, 211	Infrarrojo . . . . .	437
Fiamma scintillante . . . . .	437	Innershape . . . . .	421
Fiammingo . . . . .	351–352	Jiggle . . . . .	302
Filament . . . . .	405–411, 425	Juwel . . . . .	398
Finja . . . . .	273	Klipp Klapp . . . . .	296
Fitting . . . . .	143	Kura . . . . .	24
FixedLED . . . . .	110	Lamp holder . . . . .	211
Flame . . . . .	351–352	Lampada a infrarossi . . . . .	437
Flame- color cálido . . . . .	351–352	Lampade a goccia . . . . .	408
FlexLED . . . . .	245	Leaf . . . . .	290
Flickering candle . . . . .	437	Leonis . . . . .	280
Floor Profil 1m . . . . .	256	Liao . . . . .	62
Floor recessed luminaires . . . . .325, 327–328, 331–332, 334, 358–360, 381		Linja . . . . .	25
Foco de pinza . . . . .	272	Luce di lettura . . . . .	287







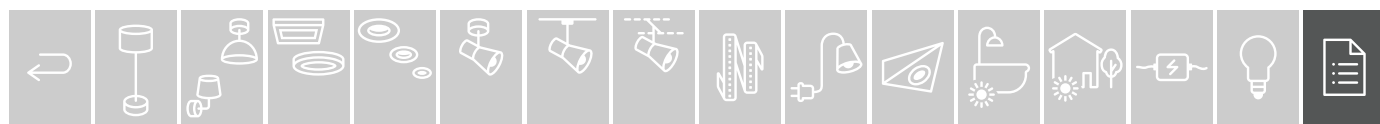

	☐		☐
Luce nera . . . . .	437	Oven . . . . .	437
Luce per specchi . . . . .	287, 289	PIR-Sensor . . . . .	237
Luci da bagno . . . . .	71, 304–319	Paletti . . . . .	330, 377
Luminaria de baño . . . . .	71, 304–319	Panel . . . . .	75–77, 136–137
Luminaria de lectura . . . . .	287	Park+Light . . . . .	348
Luminaria de noche . . . . .	271	Pendant lamps . . . . .	29, 49–50
Luminaria de superficie . . . . .	291–293	Pendant . . . . .	152, 168, 170, 172, 182
Luminaria pendular . . . . .	29, 49–50, 152, 168, 170, 172, 182	Pendelleuchten . . . . .	29, 49–50
Luminarias empotrables en el suelo . . . . .	325, 327–328, 331–332, 334, 358–360, 381	Perfil . . . . .	259–261, 263
Luminarias para espejos . . . . .	287, 289	Pia . . . . .	58
Lunar . . . . .	85	Pinja . . . . .	59
Luz negra . . . . .	437	Plant growth . . . . .	432
Lámpara infrarroja . . . . .	437	Plattern . . . . .	292
Lámparas de llama de gota . . . . .	408	Plaza . . . . .	270
Mac II . . . . .	205	Pollerleuchte . . . . .	335–336
Mac . . . . .	195–196	Porta-lampada . . . . .	211
Mari . . . . .	64	Portalámparas . . . . .	143, 211
MaxLED . . . . .	217–221, 224, 226, 228	Profile . . . . .	259–261, 263
Maxiflood . . . . .	398	Profilo . . . . .	259–261, 263
Meli . . . . .	148	Promo Panel . . . . .	133
Menja . . . . .	25	QPAR 111 . . . . .	402
Mirror light . . . . .	287, 289	Rainbow . . . . .	61
Mobil Strip . . . . .	267	Ramos . . . . .	52
Motion detector . . . . .	237, 391	Reading light . . . . .	287
Nachtlicht . . . . .	271	Recessed fitting . . . . .	142
Narve . . . . .	26	Reductor de luz . . . . .	183
Noora . . . . .	58	Riduttore . . . . .	183
Nova . . . . .	93–96, 98, 100, 104, 118	Riel . . . . .	178
Numero civico . . . . .	375	Rilevatore di movimento . . . . .	237, 391
Número de casa . . . . .	375	Ring mirror . . . . .	419
Outdoor light . . . . .	335–336	Rotate . . . . .	302–303
Outdoor . . . . .	326, 329–332, 338–340, 353–355, 357, 361	Runa . . . . .	18
		Sabik . . . . .	53, 284



			
Set Cone . . . . .	193	Testina a specchio . . . . .	416–419
Set Mac II . . . . .	204–205	Togo . . . . .	207
Set Sheela . . . . .	206	Track . . . . .	178
Set de montaje de elementos de tensión . . . . .	210	Transformador . . . . .	225, 236, 345, 387–391
Set di montaggio a trazione . . . . .	210	Transformer . . . . .	225, 236, 345, 387–391
SimplLED . . . . .	247–249	Trasformatore . . . . .	225, 236, 345, 387–391
Simplo . . . . .	288	TriX . . . . .	299
SmartHome Downlights . . . . .	103	Tube Profil . . . . .	262
SmartHome Function . . . . .	218, 229, 243–244	Tube . . . . .	291, 356
SmartHome Living room . . . . .	49, 79	URail . . . . .	172, 174–175, 177–181, 183
SmartHome Outdoor . . . . .	343	USB-Strips . . . . .	266–267
SmartHome Rail Systems . . . . .	183	Vala . . . . .	25
SmartHome Wire Systems . . . . .	186	Vane . . . . .	291
SmartHome . . . . .	10–13	VariLine . . . . .	178
SmartLight . . . . .	303	Vela de destellos . . . . .	437
SnapLED . . . . .	301	Verve . . . . .	293
Sospensione . . . . .	178, 210	WaterLED . . . . .	251
Specchio ad anello . . . . .	419	Whirl . . . . .	123, 293
Spice Salt . . . . .	206	YourLED ECO . . . . .	230
Spot Cone . . . . .	193	YourLED . . . . .	230–231, 233–235, 237–241
Spot Mac II . . . . .	204	Zed LED . . . . .	270
Spot con clip . . . . .	272	Zyli . . . . .	290
Square Profil . . . . .	258	cavo . . . . .	210
Stage . . . . .	204	easyClick2 . . . . .	116
Starter . . . . .	434	night light . . . . .	271
Suon . . . . .	122	pendolare . . . . .	152, 168, 170, 172, 182
Surface mounted light . . . . .	291–293	tension cable . . . . .	210
Suspension . . . . .	178, 210		
Suspensión . . . . .	178, 210		
Taija . . . . .	374		
Teja . . . . .	149		
Tension fitting kit . . . . .	210		
Tessa . . . . .	57		







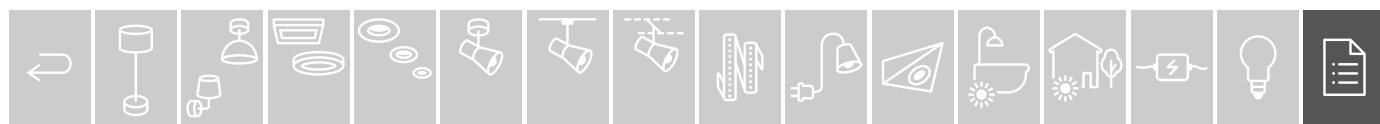

											
<u>127.08</u>	<u>436</u>	<u>284.01</u>	<u>413</u>	<u>286.03</u>	<u>423</u>	<u>286.42</u>	<u>410</u>	<u>286.87</u>	<u>406</u>	<u>287.23</u>	<u>425</u>
<u>128.08</u>	<u>436</u>	<u>284.02</u>	<u>413</u>	<u>286.10</u>	<u>406</u>	<u>286.43</u>	<u>405</u>	<u>286.88</u>	<u>406</u>	<u>287.24</u>	<u>425</u>
<u>178.03</u>	<u>210</u>	<u>284.03</u>	<u>413</u>	<u>286.11</u>	<u>405</u>	<u>286.45</u>	<u>406</u>	<u>286.89</u>	<u>407</u>	<u>287.27</u>	<u>406</u>
<u>178.06</u>	<u>210</u>	<u>284.06</u>	<u>412</u>	<u>286.12</u>	<u>406</u>	<u>286.47</u>	<u>409</u>	<u>286.90</u>	<u>407</u>	<u>287.28</u>	<u>408</u>
<u>178.24</u>	<u>210</u>	<u>284.07</u>	<u>412</u>	<u>286.13</u>	<u>406</u>	<u>286.50</u>	<u>407</u>	<u>286.91</u>	<u>407</u>	<u>287.29</u>	<u>410</u>
<u>178.34</u>	<u>210</u>	<u>284.26</u>	<u>399</u>	<u>286.14</u>	<u>409</u>	<u>286.52</u>	<u>408</u>	<u>286.92</u>	<u>407</u>	<u>287.32</u>	<u>432</u>
<u>179.43</u>	<u>113</u>	<u>284.27</u>	<u>399</u>	<u>286.15</u>	<u>410</u>	<u>286.54</u>	<u>407</u>	<u>286.93</u>	<u>408</u>	<u>287.33</u>	<u>432</u>
<u>179.45</u>	<u>113</u>	<u>284.30</u>	<u>402</u>	<u>286.16</u>	<u>409</u>	<u>286.55</u>	<u>407</u>	<u>286.94</u>	<u>408</u>	<u>287.34</u>	<u>432</u>
<u>179.46</u>	<u>113</u>	<u>284.44</u>	<u>399</u>	<u>286.17</u>	<u>410</u>	<u>286.56</u>	<u>408</u>	<u>286.95</u>	<u>409</u>	<u>287.35</u>	<u>402</u>
<u>179.51</u>	<u>114</u>	<u>285.14</u>	<u>402</u>	<u>286.18</u>	<u>410</u>	<u>286.57</u>	<u>408</u>	<u>286.96</u>	<u>409</u>	<u>287.36</u>	<u>432</u>
<u>179.53</u>	<u>114</u>	<u>285.15</u>	<u>398</u>	<u>286.19</u>	<u>409</u>	<u>286.63</u>	<u>416</u>	<u>286.97</u>	<u>409</u>	<u>287.37</u>	<u>432</u>
<u>179.54</u>	<u>114</u>	<u>285.21</u>	<u>413</u>	<u>286.20</u>	<u>409</u>	<u>286.64</u>	<u>416</u>	<u>286.98</u>	<u>409</u>	<u>287.38</u>	<u>405</u>
<u>179.55</u>	<u>114</u>	<u>285.22</u>	<u>412</u>	<u>286.21</u>	<u>410</u>	<u>286.65</u>	<u>416</u>	<u>286.99</u>	<u>410</u>	<u>287.39</u>	<u>407</u>
<u>180.00</u>	<u>352</u>	<u>285.23</u>	<u>412</u>	<u>286.22</u>	<u>410</u>	<u>286.67</u>	<u>416</u>	<u>287.00</u>	<u>410</u>	<u>287.42</u>	<u>420</u>
<u>180.01</u>	<u>352</u>	<u>285.24</u>	<u>412</u>	<u>286.23</u>	<u>411</u>	<u>286.68</u>	<u>416</u>	<u>287.01</u>	<u>411</u>	<u>287.43</u>	<u>420</u>
<u>180.02</u>	<u>353</u>	<u>285.25</u>	<u>412</u>	<u>286.24</u>	<u>411</u>	<u>286.69</u>	<u>417</u>	<u>287.02</u>	<u>411</u>	<u>287.44</u>	<u>420</u>
<u>180.03</u>	<u>353</u>	<u>285.26</u>	<u>412</u>	<u>286.25</u>	<u>411</u>	<u>286.70</u>	<u>417</u>	<u>287.03</u>	<u>411</u>	<u>287.45</u>	<u>428</u>
<u>180.10</u>	<u>344</u>	<u>285.37</u>	<u>399</u>	<u>286.26</u>	<u>411</u>	<u>286.71</u>	<u>417</u>	<u>287.04</u>	<u>426</u>	<u>287.46</u>	<u>428</u>
<u>180.11</u>	<u>344</u>	<u>285.38</u>	<u>399</u>	<u>286.27</u>	<u>411</u>	<u>286.72</u>	<u>417</u>	<u>287.05</u>	<u>426</u>	<u>287.47</u>	<u>428</u>
<u>180.12</u>	<u>343</u>	<u>285.70</u>	<u>409</u>	<u>286.28</u>	<u>411</u>	<u>286.73</u>	<u>417</u>	<u>287.06</u>	<u>426</u>	<u>287.50</u>	<u>428</u>
<u>216</u>	<u>143</u>	<u>285.71</u>	<u>409</u>	<u>286.29</u>	<u>408</u>	<u>286.74</u>	<u>417</u>	<u>287.07</u>	<u>426</u>	<u>287.51</u>	<u>401</u>
<u>217</u>	<u>143</u>	<u>285.72</u>	<u>405</u>	<u>286.30</u>	<u>407</u>	<u>286.75</u>	<u>418</u>	<u>287.08</u>	<u>426</u>	<u>287.52</u>	<u>401</u>
<u>218.9</u>	<u>143</u>	<u>285.73</u>	<u>407</u>	<u>286.31</u>	<u>408</u>	<u>286.76</u>	<u>418</u>	<u>287.09</u>	<u>426</u>	<u>287.53</u>	<u>401</u>
<u>232</u>	<u>364</u>	<u>285.77</u>	<u>402</u>	<u>286.32</u>	<u>408</u>	<u>286.77</u>	<u>418</u>	<u>287.10</u>	<u>427</u>	<u>287.54</u>	<u>401</u>
<u>233</u>	<u>143</u>	<u>285.78</u>	<u>399</u>	<u>286.33</u>	<u>407</u>	<u>286.78</u>	<u>418</u>	<u>287.11</u>	<u>427</u>	<u>287.55</u>	<u>401</u>
<u>236</u>	<u>142</u>	<u>285.79</u>	<u>399</u>	<u>286.34</u>	<u>408</u>	<u>286.79</u>	<u>419</u>	<u>287.12</u>	<u>427</u>	<u>287.56</u>	<u>401</u>
<u>237</u>	<u>364</u>	<u>285.80</u>	<u>399</u>	<u>286.35</u>	<u>408</u>	<u>286.80</u>	<u>419</u>	<u>287.13</u>	<u>427</u>	<u>287.57</u>	<u>398</u>
<u>281.10</u>	<u>403</u>	<u>285.81</u>	<u>402</u>	<u>286.36</u>	<u>406</u>	<u>286.81</u>	<u>419</u>	<u>287.14</u>	<u>427</u>	<u>287.58</u>	<u>398</u>
<u>281.11</u>	<u>403</u>	<u>285.98</u>	<u>422</u>	<u>286.37</u>	<u>406</u>	<u>286.82</u>	<u>419</u>	<u>287.15</u>	<u>427</u>	<u>287.59</u>	<u>398</u>
<u>283.29</u>	<u>398</u>	<u>285.99</u>	<u>422</u>	<u>286.38</u>	<u>408</u>	<u>286.83</u>	<u>405</u>	<u>287.16</u>	<u>427</u>	<u>287.60</u>	<u>406</u>
<u>283.30</u>	<u>398</u>	<u>286.00</u>	<u>423</u>	<u>286.39</u>	<u>408</u>	<u>286.84</u>	<u>405</u>	<u>287.17</u>	<u>427</u>	<u>287.61</u>	<u>408</u>
<u>283.99</u>	<u>413</u>	<u>286.01</u>	<u>423</u>	<u>286.40</u>	<u>407</u>	<u>286.85</u>	<u>406</u>	<u>287.21</u>	<u>425</u>	<u>287.62</u>	<u>410</u>
<u>284.00</u>	<u>413</u>	<u>286.02</u>	<u>423</u>	<u>286.41</u>	<u>409</u>	<u>286.86</u>	<u>406</u>	<u>287.22</u>	<u>425</u>	<u>287.63</u>	<u>421</u>









	☰		☰		☰		☰		☰		☰
<u>287.64</u>	<u>421</u>	<u>288.04</u>	<u>424</u>	<u>288.55</u>	<u>405</u>	<u>500.01</u>	<u>12</u>	<u>501.29</u>	<u>431</u>	<u>603.26</u>	<u>153</u>
<u>287.65</u>	<u>421</u>	<u>288.05</u>	<u>424</u>	<u>288.56</u>	<u>409</u>	<u>500.02</u>	<u>229</u>	<u>501.30</u>	<u>431</u>	<u>603.49</u>	<u>153</u>
<u>287.66</u>	<u>421</u>	<u>288.06</u>	<u>400</u>	<u>288.57</u>	<u>407</u>	<u>500.03</u>	<u>229</u>	<u>503.46</u>	<u>318</u>	<u>603.50</u>	<u>153</u>
<u>287.68</u>	<u>421</u>	<u>288.07</u>	<u>400</u>	<u>288.58</u>	<u>415</u>	<u>500.04</u>	<u>229</u>	<u>503.81</u>	<u>36</u>	<u>603.51</u>	<u>153</u>
<u>287.69</u>	<u>421</u>	<u>288.08</u>	<u>400</u>	<u>288.59</u>	<u>415</u>	<u>500.05</u>	<u>243</u>	<u>503.82</u>	<u>36</u>	<u>603.52</u>	<u>153</u>
<u>287.70</u>	<u>420</u>	<u>288.09</u>	<u>400</u>	<u>288.60</u>	<u>415</u>	<u>500.16</u>	<u>186</u>	<u>503.83</u>	<u>36</u>	<u>666.38</u>	<u>145</u>
<u>287.71</u>	<u>429</u>	<u>288.10</u>	<u>400</u>	<u>288.61</u>	<u>414</u>	<u>500.17</u>	<u>12</u>	<u>503.85</u>	<u>38</u>	<u>666.39</u>	<u>145</u>
<u>287.72</u>	<u>429</u>	<u>288.11</u>	<u>397</u>	<u>288.62</u>	<u>414</u>	<u>500.18</u>	<u>12</u>	<u>503.86</u>	<u>38</u>	<u>666.40</u>	<u>145</u>
<u>287.73</u>	<u>429</u>	<u>288.13</u>	<u>397</u>	<u>288.63</u>	<u>414</u>	<u>500.38</u>	<u>242</u>	<u>503.87</u>	<u>33</u>	<u>666.87</u>	<u>148</u>
<u>287.74</u>	<u>429</u>	<u>288.14</u>	<u>397</u>	<u>288.64</u>	<u>414</u>	<u>500.39</u>	<u>242</u>	<u>503.88</u>	<u>43</u>	<u>666.88</u>	<u>148</u>
<u>287.75</u>	<u>397</u>	<u>288.15</u>	<u>410</u>	<u>288.65</u>	<u>415</u>	<u>500.43</u>	<u>13</u>	<u>503.89</u>	<u>37</u>	<u>666.89</u>	<u>148</u>
<u>287.76</u>	<u>409</u>	<u>288.16</u>	<u>410</u>	<u>288.66</u>	<u>414</u>	<u>500.44</u>	<u>13</u>	<u>503.90</u>	<u>37</u>	<u>666.98</u>	<u>149</u>
<u>287.77</u>	<u>405</u>	<u>288.17</u>	<u>409</u>	<u>288.67</u>	<u>413</u>	<u>500.45</u>	<u>229</u>	<u>503.91</u>	<u>430</u>	<u>666.99</u>	<u>149</u>
<u>287.78</u>	<u>407</u>	<u>288.18</u>	<u>397</u>	<u>288.68</u>	<u>413</u>	<u>500.46</u>	<u>229</u>	<u>503.92</u>	<u>430</u>	<u>667.00</u>	<u>149</u>
<u>287.79</u>	<u>411</u>	<u>288.19</u>	<u>400</u>	<u>288.69</u>	<u>413</u>	<u>500.47</u>	<u>229</u>	<u>503.93</u>	<u>430</u>	<u>667.01</u>	<u>149</u>
<u>287.84</u>	<u>107</u>	<u>288.20</u>	<u>400</u>	<u>288.71</u>	<u>399</u>	<u>500.48</u>	<u>242</u>	<u>503.94</u>	<u>430</u>	<u>667.02</u>	<u>149</u>
<u>287.85</u>	<u>107</u>	<u>288.21</u>	<u>397</u>	<u>288.72</u>	<u>398</u>	<u>500.49</u>	<u>242</u>	<u>503.95</u>	<u>430</u>	<u>667.03</u>	<u>149</u>
<u>287.86</u>	<u>107</u>	<u>288.22</u>	<u>397</u>	<u>288.73</u>	<u>398</u>	<u>500.50</u>	<u>183</u>	<u>503.96</u>	<u>430</u>	<u>667.04</u>	<u>149</u>
<u>287.87</u>	<u>107</u>	<u>288.24</u>	<u>397</u>	<u>288.74</u>	<u>398</u>	<u>500.51</u>	<u>183</u>	<u>530.00</u>	<u>437</u>	<u>667.05</u>	<u>149</u>
<u>287.88</u>	<u>405</u>	<u>288.25</u>	<u>397</u>	<u>289.02</u>	<u>404</u>	<u>500.67</u>	<u>13</u>	<u>530.03</u>	<u>437</u>	<u>667.10</u>	<u>316</u>
<u>287.89</u>	<u>408</u>	<u>288.26</u>	<u>402</u>	<u>289.03</u>	<u>404</u>	<u>500.80</u>	<u>244</u>	<u>531.00</u>	<u>437</u>	<u>667.11</u>	<u>316</u>
<u>287.92</u>	<u>424</u>	<u>288.27</u>	<u>423</u>	<u>289.04</u>	<u>404</u>	<u>500.81</u>	<u>244</u>	<u>549.27</u>	<u>435</u>	<u>667.12</u>	<u>316</u>
<u>287.93</u>	<u>424</u>	<u>288.28</u>	<u>423</u>	<u>289.10</u>	<u>398</u>	<u>501.07</u>	<u>186</u>	<u>549.28</u>	<u>435</u>	<u>667.13</u>	<u>316</u>
<u>287.94</u>	<u>424</u>	<u>288.29</u>	<u>423</u>	<u>3725</u>	<u>133</u>	<u>501.09</u>	<u>186</u>	<u>549.29</u>	<u>401</u>	<u>667.17</u>	<u>317</u>
<u>287.95</u>	<u>424</u>	<u>288.30</u>	<u>423</u>	<u>3726</u>	<u>133</u>	<u>501.20</u>	<u>183</u>	<u>5792</u>	<u>115</u>	<u>667.18</u>	<u>317</u>
<u>287.96</u>	<u>400</u>	<u>288.31</u>	<u>412</u>	<u>3980</u>	<u>202</u>	<u>501.21</u>	<u>183</u>	<u>5796</u>	<u>115</u>	<u>667.19</u>	<u>317</u>
<u>287.97</u>	<u>402</u>	<u>288.32</u>	<u>414</u>	<u>3981</u>	<u>202</u>	<u>501.22</u>	<u>431</u>	<u>590.70</u>	<u>437</u>	<u>667.43</u>	<u>146</u>
<u>287.98</u>	<u>402</u>	<u>288.33</u>	<u>397</u>	<u>404000125</u>	<u>143</u>	<u>501.23</u>	<u>431</u>	<u>600.04</u>	<u>153</u>	<u>667.44</u>	<u>146</u>
<u>287.99</u>	<u>400</u>	<u>288.34</u>	<u>400</u>	<u>404000752</u>	<u>143</u>	<u>501.24</u>	<u>431</u>	<u>600.07</u>	<u>153</u>	<u>667.45</u>	<u>146</u>
<u>288.00</u>	<u>400</u>	<u>288.35</u>	<u>403</u>	<u>404000753</u>	<u>143</u>	<u>501.25</u>	<u>431</u>	<u>600.11</u>	<u>153</u>	<u>667.46</u>	<u>146</u>
<u>288.01</u>	<u>400</u>	<u>288.36</u>	<u>403</u>	<u>404001963</u>	<u>143</u>	<u>501.26</u>	<u>431</u>	<u>600.12</u>	<u>153</u>	<u>667.50</u>	<u>317</u>
<u>288.02</u>	<u>424</u>	<u>288.37</u>	<u>403</u>	<u>444.08</u>	<u>436</u>	<u>501.27</u>	<u>431</u>	<u>600.15</u>	<u>153</u>	<u>667.51</u>	<u>317</u>
<u>288.03</u>	<u>424</u>	<u>288.38</u>	<u>403</u>	<u>449.08</u>	<u>436</u>	<u>501.28</u>	<u>431</u>	<u>600.55</u>	<u>153</u>	<u>667.52</u>	<u>317</u>









											
<u>667.54</u>	<u>146</u>	<u>702.62</u>	<u>255</u>	<u>704.41</u>	<u>257</u>	<u>705.44</u>	<u>61</u>	<u>705.94</u>	<u>231</u>	<u>706.50</u>	<u>85</u>
<u>667.55</u>	<u>147</u>	<u>702.63</u>	<u>255</u>	<u>704.42</u>	<u>257</u>	<u>705.45</u>	<u>61</u>	<u>705.99</u>	<u>240</u>	<u>706.51</u>	<u>85</u>
<u>667.56</u>	<u>147</u>	<u>702.64</u>	<u>255</u>	<u>704.51</u>	<u>391</u>	<u>705.46</u>	<u>61</u>	<u>706.04</u>	<u>218</u>	<u>706.52</u>	<u>85</u>
<u>667.57</u>	<u>147</u>	<u>702.65</u>	<u>255</u>	<u>704.51</u>	<u>237</u>	<u>705.47</u>	<u>61</u>	<u>706.05</u>	<u>218</u>	<u>706.53</u>	<u>85</u>
<u>667.58</u>	<u>147</u>	<u>702.66</u>	<u>255</u>	<u>704.51</u>	<u>391</u>	<u>705.48</u>	<u>219</u>	<u>706.06</u>	<u>300</u>	<u>706.54</u>	<u>85</u>
<u>667.59</u>	<u>148</u>	<u>702.67</u>	<u>253</u>	<u>704.51</u>	<u>237</u>	<u>705.49</u>	<u>219</u>	<u>706.12</u>	<u>300</u>	<u>706.55</u>	<u>85</u>
<u>667.60</u>	<u>148</u>	<u>702.68</u>	<u>253</u>	<u>704.53</u>	<u>253</u>	<u>705.50</u>	<u>219</u>	<u>706.13</u>	<u>300</u>	<u>706.56</u>	<u>85</u>
<u>667.61</u>	<u>148</u>	<u>702.69</u>	<u>253</u>	<u>704.55</u>	<u>266</u>	<u>705.51</u>	<u>219</u>	<u>706.14</u>	<u>300</u>	<u>706.63</u>	<u>219</u>
<u>667.62</u>	<u>148</u>	<u>702.70</u>	<u>253</u>	<u>704.56</u>	<u>266</u>	<u>705.57</u>	<u>264</u>	<u>706.15</u>	<u>224</u>	<u>706.64</u>	<u>219</u>
<u>667.63</u>	<u>146</u>	<u>702.72</u>	<u>253</u>	<u>704.58</u>	<u>230</u>	<u>705.58</u>	<u>264</u>	<u>706.16</u>	<u>224</u>	<u>706.65</u>	<u>219</u>
<u>667.64</u>	<u>146</u>	<u>702.74</u>	<u>253</u>	<u>704.59</u>	<u>230</u>	<u>705.59</u>	<u>262</u>	<u>706.17</u>	<u>224</u>	<u>706.66</u>	<u>219</u>
<u>667.65</u>	<u>146</u>	<u>702.75</u>	<u>253</u>	<u>704.60</u>	<u>230</u>	<u>705.60</u>	<u>262</u>	<u>706.18</u>	<u>224</u>	<u>706.67</u>	<u>219</u>
<u>701.74</u>	<u>153</u>	<u>702.82</u>	<u>240</u>	<u>704.61</u>	<u>235</u>	<u>705.61</u>	<u>264</u>	<u>706.19</u>	<u>228</u>	<u>706.68</u>	<u>219</u>
<u>701.99</u>	<u>236</u>	<u>703.17</u>	<u>231</u>	<u>704.63</u>	<u>309</u>	<u>705.62</u>	<u>264</u>	<u>706.23</u>	<u>219</u>	<u>706.69</u>	<u>221</u>
<u>702.00</u>	<u>236</u>	<u>703.18</u>	<u>231</u>	<u>704.64</u>	<u>309</u>	<u>705.63</u>	<u>264</u>	<u>706.24</u>	<u>219</u>	<u>706.70</u>	<u>221</u>
<u>702.01</u>	<u>236</u>	<u>703.19</u>	<u>231</u>	<u>704.68</u>	<u>313</u>	<u>705.64</u>	<u>264</u>	<u>706.27</u>	<u>219</u>	<u>706.71</u>	<u>221</u>
<u>702.02</u>	<u>234</u>	<u>703.20</u>	<u>231</u>	<u>704.70</u>	<u>311</u>	<u>705.68</u>	<u>221</u>	<u>706.28</u>	<u>219</u>	<u>706.72</u>	<u>221</u>
<u>702.03</u>	<u>240</u>	<u>703.21</u>	<u>231</u>	<u>704.80</u>	<u>246</u>	<u>705.69</u>	<u>221</u>	<u>706.30</u>	<u>219</u>	<u>706.75</u>	<u>221</u>
<u>702.04</u>	<u>240</u>	<u>703.22</u>	<u>231</u>	<u>704.81</u>	<u>246</u>	<u>705.74</u>	<u>224</u>	<u>706.34</u>	<u>219</u>	<u>706.76</u>	<u>221</u>
<u>702.08</u>	<u>231</u>	<u>703.34</u>	<u>241</u>	<u>704.86</u>	<u>241</u>	<u>705.75</u>	<u>224</u>	<u>706.35</u>	<u>302</u>	<u>706.83</u>	<u>228</u>
<u>702.09</u>	<u>231</u>	<u>703.50</u>	<u>309</u>	<u>704.88</u>	<u>241</u>	<u>705.76</u>	<u>224</u>	<u>706.36</u>	<u>302</u>	<u>706.96</u>	<u>246</u>
<u>702.10</u>	<u>231</u>	<u>703.54</u>	<u>308</u>	<u>704.89</u>	<u>241</u>	<u>705.77</u>	<u>218</u>	<u>706.37</u>	<u>303</u>	<u>706.97</u>	<u>246</u>
<u>702.15</u>	<u>240</u>	<u>703.98</u>	<u>299</u>	<u>704.90</u>	<u>241</u>	<u>705.78</u>	<u>218</u>	<u>706.38</u>	<u>303</u>	<u>707.00</u>	<u>267</u>
<u>702.21</u>	<u>253</u>	<u>704.09</u>	<u>256</u>	<u>704.98</u>	<u>301</u>	<u>705.79</u>	<u>218</u>	<u>706.39</u>	<u>303</u>	<u>707.01</u>	<u>267</u>
<u>702.45</u>	<u>270</u>	<u>704.10</u>	<u>256</u>	<u>705.10</u>	<u>233</u>	<u>705.80</u>	<u>218</u>	<u>706.41</u>	<u>85</u>	<u>707.02</u>	<u>267</u>
<u>702.51</u>	<u>240</u>	<u>704.17</u>	<u>251</u>	<u>705.13</u>	<u>247</u>	<u>705.81</u>	<u>218</u>	<u>706.42</u>	<u>85</u>	<u>707.05</u>	<u>267</u>
<u>702.52</u>	<u>230</u>	<u>704.18</u>	<u>251</u>	<u>705.14</u>	<u>247</u>	<u>705.82</u>	<u>218</u>	<u>706.43</u>	<u>85</u>	<u>707.06</u>	<u>267</u>
<u>702.53</u>	<u>230</u>	<u>704.19</u>	<u>251</u>	<u>705.15</u>	<u>247</u>	<u>705.85</u>	<u>221</u>	<u>706.44</u>	<u>85</u>	<u>707.22</u>	<u>306</u>
<u>702.54</u>	<u>230</u>	<u>704.28</u>	<u>230</u>	<u>705.16</u>	<u>226</u>	<u>705.86</u>	<u>221</u>	<u>706.45</u>	<u>85</u>	<u>707.24</u>	<u>306</u>
<u>702.55</u>	<u>230</u>	<u>704.29</u>	<u>230</u>	<u>705.17</u>	<u>259</u>	<u>705.88</u>	<u>221</u>	<u>706.46</u>	<u>85</u>	<u>707.26</u>	<u>237</u>
<u>702.56</u>	<u>230</u>	<u>704.30</u>	<u>230</u>	<u>705.18</u>	<u>259</u>	<u>705.89</u>	<u>221</u>	<u>706.47</u>	<u>85</u>	<u>707.27</u>	<u>237</u>
<u>702.57</u>	<u>230</u>	<u>704.39</u>	<u>257</u>	<u>705.19</u>	<u>253</u>	<u>705.92</u>	<u>231</u>	<u>706.48</u>	<u>85</u>	<u>707.76</u>	<u>298</u>
<u>702.61</u>	<u>255</u>	<u>704.40</u>	<u>257</u>	<u>705.20</u>	<u>253</u>	<u>705.93</u>	<u>231</u>	<u>706.49</u>	<u>85</u>	<u>707.77</u>	<u>298</u>







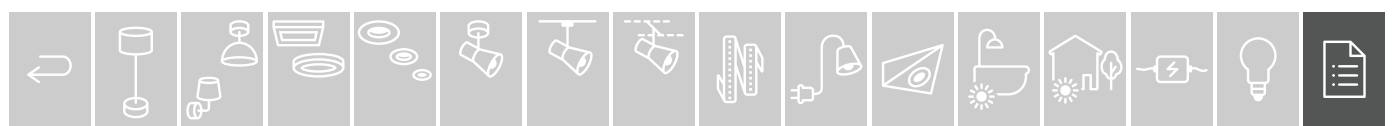

											
707.90	<u>71</u>	<u>708.80</u>	<u>314</u>	<u>709.33</u>	<u>84</u>	<u>709.82</u>	<u>86</u>	<u>710.15</u>	<u>83</u>	<u>789.56</u>	<u>248</u>
707.91	<u>71</u>	<u>708.81</u>	<u>314</u>	<u>709.34</u>	<u>84</u>	<u>709.83</u>	<u>86</u>	<u>710.16</u>	<u>82</u>	<u>789.57</u>	<u>248</u>
707.92	<u>71</u>	<u>708.82</u>	<u>307</u>	<u>709.35</u>	<u>84</u>	<u>709.84</u>	<u>86</u>	<u>710.17</u>	<u>82</u>	<u>789.58</u>	<u>248</u>
708.09	<u>258</u>	<u>708.83</u>	<u>307</u>	<u>709.36</u>	<u>84</u>	<u>709.85</u>	<u>86</u>	<u>710.18</u>	<u>81</u>	<u>789.59</u>	<u>248</u>
708.10	<u>258</u>	<u>708.85</u>	<u>266</u>	<u>709.37</u>	<u>84</u>	<u>709.86</u>	<u>87</u>	<u>710.19</u>	<u>81</u>	<u>789.60</u>	<u>248</u>
708.27	<u>218</u>	<u>708.86</u>	<u>266</u>	<u>709.38</u>	<u>84</u>	<u>709.87</u>	<u>87</u>	<u>710.20</u>	<u>81</u>	<u>789.61</u>	<u>245</u>
708.28	<u>218</u>	<u>708.90</u>	<u>319</u>	<u>709.39</u>	<u>84</u>	<u>709.88</u>	<u>87</u>	<u>749.95</u>	<u>270</u>	<u>789.62</u>	<u>245</u>
708.29	<u>218</u>	<u>708.91</u>	<u>319</u>	<u>709.40</u>	<u>84</u>	<u>709.89</u>	<u>87</u>	<u>770.10</u>	<u>58</u>	<u>789.63</u>	<u>245</u>
708.30	<u>218</u>	<u>708.95</u>	<u>319</u>	<u>709.41</u>	<u>84</u>	<u>709.90</u>	<u>83</u>	<u>770.55</u>	<u>59</u>	<u>789.64</u>	<u>245</u>
708.38	<u>308</u>	<u>708.99</u>	<u>86</u>	<u>709.42</u>	<u>62</u>	<u>709.91</u>	<u>83</u>	<u>770.56</u>	<u>59</u>	<u>789.65</u>	<u>245</u>
708.39	<u>308</u>	<u>709.00</u>	<u>86</u>	<u>709.45</u>	<u>62</u>	<u>709.92</u>	<u>82</u>	<u>770.57</u>	<u>59</u>	<u>789.66</u>	<u>245</u>
708.55	<u>260</u>	<u>709.06</u>	<u>62</u>	<u>709.46</u>	<u>53</u>	<u>709.93</u>	<u>83</u>	<u>770.58</u>	<u>58</u>	<u>789.72</u>	<u>249</u>
708.56	<u>260</u>	<u>709.07</u>	<u>218</u>	<u>709.47</u>	<u>53</u>	<u>709.94</u>	<u>83</u>	<u>770.59</u>	<u>58</u>	<u>789.73</u>	<u>249</u>
708.58	<u>261</u>	<u>709.08</u>	<u>218</u>	<u>709.48</u>	<u>311</u>	<u>709.95</u>	<u>82</u>	<u>789.01</u>	<u>259</u>	<u>789.74</u>	<u>249</u>
708.59	<u>261</u>	<u>709.09</u>	<u>246</u>	<u>709.51</u>	<u>64</u>	<u>709.96</u>	<u>82</u>	<u>789.02</u>	<u>259</u>	<u>789.75</u>	<u>249</u>
708.60	<u>263</u>	<u>709.10</u>	<u>238</u>	<u>709.52</u>	<u>64</u>	<u>709.97</u>	<u>83</u>	<u>789.03</u>	<u>258</u>	<u>789.76</u>	<u>249</u>
708.61	<u>263</u>	<u>709.11</u>	<u>235</u>	<u>709.54</u>	<u>232</u>	<u>709.98</u>	<u>83</u>	<u>789.04</u>	<u>258</u>	<u>789.77</u>	<u>249</u>
708.62	<u>260</u>	<u>709.12</u>	<u>234</u>	<u>709.55</u>	<u>232</u>	<u>709.99</u>	<u>82</u>	<u>789.05</u>	<u>250</u>	<u>789.78</u>	<u>249</u>
708.63	<u>260</u>	<u>709.13</u>	<u>238</u>	<u>709.56</u>	<u>232</u>	<u>710.00</u>	<u>83</u>	<u>789.06</u>	<u>250</u>	<u>789.79</u>	<u>249</u>
708.64	<u>84</u>	<u>709.14</u>	<u>239</u>	<u>709.61</u>	<u>238</u>	<u>710.01</u>	<u>83</u>	<u>789.07</u>	<u>250</u>	<u>789.80</u>	<u>249</u>
708.65	<u>84</u>	<u>709.15</u>	<u>239</u>	<u>709.62</u>	<u>223</u>	<u>710.02</u>	<u>82</u>	<u>789.08</u>	<u>250</u>	<u>795.19</u>	<u>18</u>
708.66	<u>84</u>	<u>709.16</u>	<u>239</u>	<u>709.63</u>	<u>223</u>	<u>710.03</u>	<u>82</u>	<u>789.13</u>	<u>67</u>	<u>795.20</u>	<u>18</u>
708.67	<u>84</u>	<u>709.17</u>	<u>233</u>	<u>709.64</u>	<u>223</u>	<u>710.04</u>	<u>83</u>	<u>789.14</u>	<u>67</u>	<u>795.21</u>	<u>18</u>
708.68	<u>84</u>	<u>709.18</u>	<u>240</u>	<u>709.65</u>	<u>223</u>	<u>710.05</u>	<u>83</u>	<u>789.15</u>	<u>68</u>	<u>795.22</u>	<u>18</u>
708.69	<u>84</u>	<u>709.19</u>	<u>224</u>	<u>709.66</u>	<u>223</u>	<u>710.06</u>	<u>82</u>	<u>789.16</u>	<u>70</u>	<u>795.23</u>	<u>18</u>
708.70	<u>84</u>	<u>709.20</u>	<u>52</u>	<u>709.67</u>	<u>223</u>	<u>710.07</u>	<u>83</u>	<u>789.17</u>	<u>69</u>	<u>795.24</u>	<u>18</u>
708.71	<u>84</u>	<u>709.22</u>	<u>57</u>	<u>709.68</u>	<u>265</u>	<u>710.08</u>	<u>83</u>	<u>789.18</u>	<u>69</u>	<u>796.00</u>	<u>40</u>
708.72	<u>84</u>	<u>709.23</u>	<u>57</u>	<u>709.69</u>	<u>265</u>	<u>710.09</u>	<u>82</u>	<u>789.19</u>	<u>70</u>	<u>796.01</u>	<u>41</u>
708.73	<u>84</u>	<u>709.24</u>	<u>57</u>	<u>709.74</u>	<u>227</u>	<u>710.10</u>	<u>82</u>	<u>789.20</u>	<u>68</u>	<u>796.09</u>	<u>40</u>
708.74	<u>307</u>	<u>709.25</u>	<u>55</u>	<u>709.75</u>	<u>227</u>	<u>710.11</u>	<u>83</u>	<u>789.21</u>	<u>87</u>	<u>796.12</u>	<u>40</u>
708.76	<u>307</u>	<u>709.28</u>	<u>55</u>	<u>709.76</u>	<u>226</u>	<u>710.12</u>	<u>83</u>	<u>789.22</u>	<u>87</u>	<u>796.14</u>	<u>40</u>
708.78	<u>311</u>	<u>709.29</u>	<u>54</u>	<u>709.80</u>	<u>306</u>	<u>710.13</u>	<u>82</u>	<u>789.23</u>	<u>87</u>	<u>796.15</u>	<u>41</u>
708.79	<u>311</u>	<u>709.30</u>	<u>54</u>	<u>709.81</u>	<u>306</u>	<u>710.14</u>	<u>83</u>	<u>789.55</u>	<u>248</u>	<u>796.16</u>	<u>43</u>









											
<u>796.17</u>	<u>44</u>	<u>796.86</u>	<u>28</u>	<u>797.50</u>	<u>41</u>	<u>798.18</u>	<u>77</u>	<u>798.63</u>	<u>216</u>	<u>800.12</u>	<u>436</u>
<u>796.18</u>	<u>43</u>	<u>796.87</u>	<u>28</u>	<u>797.51</u>	<u>40</u>	<u>798.19</u>	<u>77</u>	<u>798.64</u>	<u>216</u>	<u>800.15</u>	<u>436</u>
<u>796.21</u>	<u>43</u>	<u>796.90</u>	<u>35</u>	<u>797.53</u>	<u>317</u>	<u>798.20</u>	<u>76</u>	<u>798.65</u>	<u>216</u>	<u>800.87</u>	<u>435</u>
<u>796.22</u>	<u>44</u>	<u>796.91</u>	<u>35</u>	<u>797.54</u>	<u>317</u>	<u>798.21</u>	<u>76</u>	<u>798.66</u>	<u>216</u>	<u>800.88</u>	<u>435</u>
<u>796.24</u>	<u>45</u>	<u>796.93</u>	<u>49</u>	<u>797.55</u>	<u>24</u>	<u>798.22</u>	<u>76</u>	<u>798.67</u>	<u>216</u>	<u>800.89</u>	<u>435</u>
<u>796.25</u>	<u>45</u>	<u>796.94</u>	<u>49</u>	<u>797.56</u>	<u>24</u>	<u>798.23</u>	<u>76</u>	<u>798.68</u>	<u>217</u>	<u>800.90</u>	<u>435</u>
<u>796.26</u>	<u>44</u>	<u>797.08</u>	<u>63</u>	<u>797.57</u>	<u>19</u>	<u>798.24</u>	<u>75</u>	<u>798.69</u>	<u>217</u>	<u>800.91</u>	<u>435</u>
<u>796.28</u>	<u>33</u>	<u>797.09</u>	<u>63</u>	<u>797.58</u>	<u>19</u>	<u>798.25</u>	<u>75</u>	<u>798.70</u>	<u>217</u>	<u>820.10</u>	<u>437</u>
<u>796.29</u>	<u>33</u>	<u>797.10</u>	<u>63</u>	<u>797.59</u>	<u>19</u>	<u>798.26</u>	<u>75</u>	<u>798.71</u>	<u>217</u>	<u>820.11</u>	<u>437</u>
<u>796.33</u>	<u>31</u>	<u>797.12</u>	<u>312</u>	<u>797.60</u>	<u>19</u>	<u>798.27</u>	<u>75</u>	<u>798.72</u>	<u>217</u>	<u>829.66</u>	<u>437</u>
<u>796.34</u>	<u>30</u>	<u>797.13</u>	<u>312</u>	<u>797.61</u>	<u>19</u>	<u>798.28</u>	<u>225</u>	<u>798.73</u>	<u>217</u>	<u>829.77</u>	<u>437</u>
<u>796.35</u>	<u>31</u>	<u>797.14</u>	<u>312</u>	<u>797.62</u>	<u>19</u>	<u>798.29</u>	<u>225</u>	<u>798.74</u>	<u>217</u>	<u>831.49</u>	<u>435</u>
<u>796.36</u>	<u>30</u>	<u>797.15</u>	<u>312</u>	<u>797.63</u>	<u>20</u>	<u>798.30</u>	<u>226</u>	<u>798.75</u>	<u>217</u>	<u>831.51</u>	<u>435</u>
<u>796.40</u>	<u>29</u>	<u>797.16</u>	<u>312</u>	<u>797.64</u>	<u>20</u>	<u>798.31</u>	<u>226</u>	<u>798.76</u>	<u>217</u>	<u>831.52</u>	<u>435</u>
<u>796.44</u>	<u>33</u>	<u>797.17</u>	<u>47</u>	<u>797.65</u>	<u>20</u>	<u>798.32</u>	<u>390</u>	<u>798.77</u>	<u>217</u>	<u>831.53</u>	<u>435</u>
<u>796.46</u>	<u>30</u>	<u>797.18</u>	<u>47</u>	<u>797.66</u>	<u>21</u>	<u>798.34</u>	<u>390</u>	<u>798.78</u>	<u>217</u>	<u>831.54</u>	<u>435</u>
<u>796.50</u>	<u>28</u>	<u>797.20</u>	<u>47</u>	<u>797.67</u>	<u>21</u>	<u>798.35</u>	<u>225</u>	<u>798.79</u>	<u>217</u>	<u>831.55</u>	<u>435</u>
<u>796.51</u>	<u>32</u>	<u>797.21</u>	<u>51</u>	<u>797.68</u>	<u>21</u>	<u>798.37</u>	<u>225</u>	<u>798.80</u>	<u>217</u>	<u>884.24</u>	<u>434</u>
<u>796.52</u>	<u>32</u>	<u>797.24</u>	<u>26</u>	<u>797.69</u>	<u>53</u>	<u>798.38</u>	<u>220</u>	<u>798.81</u>	<u>217</u>	<u>884.46</u>	<u>433</u>
<u>796.53</u>	<u>32</u>	<u>797.25</u>	<u>25</u>	<u>797.70</u>	<u>38</u>	<u>798.39</u>	<u>306</u>	<u>798.82</u>	<u>217</u>	<u>884.48</u>	<u>433</u>
<u>796.54</u>	<u>32</u>	<u>797.28</u>	<u>24</u>	<u>797.71</u>	<u>38</u>	<u>798.40</u>	<u>228</u>	<u>798.83</u>	<u>217</u>	<u>884.84</u>	<u>434</u>
<u>796.55</u>	<u>32</u>	<u>797.30</u>	<u>24</u>	<u>797.86</u>	<u>47</u>	<u>798.41</u>	<u>228</u>	<u>798.90</u>	<u>77</u>	<u>885.08</u>	<u>433</u>
<u>796.56</u>	<u>34</u>	<u>797.33</u>	<u>25</u>	<u>797.97</u>	<u>228</u>	<u>798.52</u>	<u>216</u>	<u>798.91</u>	<u>77</u>	<u>885.13</u>	<u>433</u>
<u>796.57</u>	<u>34</u>	<u>797.36</u>	<u>27</u>	<u>798.08</u>	<u>79</u>	<u>798.53</u>	<u>216</u>	<u>798.92</u>	<u>76</u>	<u>885.15</u>	<u>434</u>
<u>796.58</u>	<u>34</u>	<u>797.39</u>	<u>27</u>	<u>798.09</u>	<u>79</u>	<u>798.54</u>	<u>216</u>	<u>798.93</u>	<u>76</u>	<u>885.19</u>	<u>434</u>
<u>796.60</u>	<u>34</u>	<u>797.40</u>	<u>27</u>	<u>798.10</u>	<u>79</u>	<u>798.55</u>	<u>216</u>	<u>798.95</u>	<u>75</u>	<u>885.21</u>	<u>434</u>
<u>796.61</u>	<u>41</u>	<u>797.42</u>	<u>25</u>	<u>798.11</u>	<u>66</u>	<u>798.56</u>	<u>216</u>	<u>798.97</u>	<u>75</u>	<u>885.36</u>	<u>434</u>
<u>796.63</u>	<u>44</u>	<u>797.43</u>	<u>25</u>	<u>798.12</u>	<u>66</u>	<u>798.57</u>	<u>216</u>	<u>798.99</u>	<u>75</u>	<u>885.41</u>	<u>434</u>
<u>796.64</u>	<u>29</u>	<u>797.44</u>	<u>29</u>	<u>798.13</u>	<u>224</u>	<u>798.58</u>	<u>216</u>	<u>799.04</u>	<u>78</u>	<u>885.45</u>	<u>434</u>
<u>796.65</u>	<u>45</u>	<u>797.45</u>	<u>29</u>	<u>798.14</u>	<u>221</u>	<u>798.59</u>	<u>216</u>	<u>799.05</u>	<u>78</u>	<u>885.49</u>	<u>434</u>
<u>796.66</u>	<u>357</u>	<u>797.46</u>	<u>23</u>	<u>798.15</u>	<u>50</u>	<u>798.60</u>	<u>216</u>	<u>799.07</u>	<u>78</u>	<u>885.50</u>	<u>434</u>
<u>796.70</u>	<u>357</u>	<u>797.48</u>	<u>23</u>	<u>798.16</u>	<u>77</u>	<u>798.61</u>	<u>216</u>	<u>799.08</u>	<u>78</u>	<u>885.53</u>	<u>434</u>
<u>796.82</u>	<u>35</u>	<u>797.49</u>	<u>23</u>	<u>798.17</u>	<u>77</u>	<u>798.62</u>	<u>216</u>	<u>800.11</u>	<u>436</u>	<u>885.54</u>	<u>434</u>

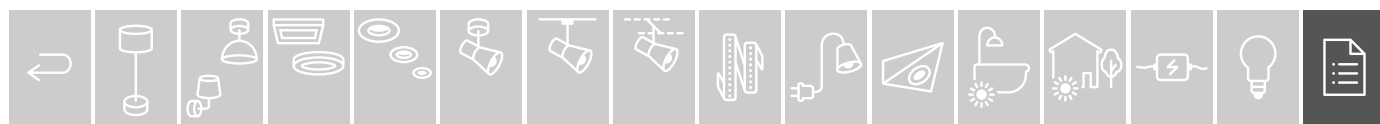









											
885.58	<u>434</u>	<u>923.98</u>	<u>125</u>	<u>929.03</u>	<u>99</u>	<u>929.62</u>	<u>103</u>	<u>930.38</u>	<u>129</u>	<u>930.71</u>	<u>117</u>
885.60	<u>433</u>	<u>924.72</u>	<u>107</u>	<u>929.04</u>	<u>99</u>	<u>929.64</u>	<u>103</u>	<u>930.39</u>	<u>129</u>	<u>930.72</u>	<u>117</u>
885.61	<u>433</u>	<u>924.73</u>	<u>107</u>	<u>929.07</u>	<u>123</u>	<u>929.65</u>	<u>103</u>	<u>930.40</u>	<u>129</u>	<u>930.73</u>	<u>118</u>
885.62	<u>433</u>	<u>924.77</u>	<u>107</u>	<u>929.08</u>	<u>123</u>	<u>929.70</u>	<u>105</u>	<u>930.41</u>	<u>129</u>	<u>930.74</u>	<u>118</u>
885.63	<u>433</u>	<u>924.78</u>	<u>107</u>	<u>929.17</u>	<u>123</u>	<u>929.71</u>	<u>105</u>	<u>930.42</u>	<u>129</u>	<u>930.75</u>	<u>118</u>
920.32	<u>291</u>	<u>924.79</u>	<u>107</u>	<u>929.22</u>	<u>139</u>	<u>929.72</u>	<u>105</u>	<u>930.43</u>	<u>132</u>	<u>930.76</u>	<u>117</u>
920.58	<u>137</u>	<u>924.80</u>	<u>107</u>	<u>929.23</u>	<u>139</u>	<u>929.73</u>	<u>105</u>	<u>930.44</u>	<u>132</u>	<u>930.77</u>	<u>117</u>
920.59	<u>137</u>	<u>924.81</u>	<u>107</u>	<u>929.24</u>	<u>139</u>	<u>929.74</u>	<u>105</u>	<u>930.45</u>	<u>132</u>	<u>930.78</u>	<u>117</u>
920.60	<u>137</u>	<u>924.82</u>	<u>107</u>	<u>929.25</u>	<u>139</u>	<u>929.75</u>	<u>105</u>	<u>930.46</u>	<u>132</u>	<u>930.79</u>	<u>117</u>
920.62	<u>136</u>	<u>924.83</u>	<u>107</u>	<u>929.26</u>	<u>140</u>	<u>929.76</u>	<u>118</u>	<u>930.47</u>	<u>132</u>	<u>933.76</u>	<u>119</u>
920.64	<u>137</u>	<u>924.84</u>	<u>107</u>	<u>929.33</u>	<u>134</u>	<u>929.77</u>	<u>93</u>	<u>930.48</u>	<u>132</u>	<u>933.77</u>	<u>119</u>
920.65	<u>137</u>	<u>924.85</u>	<u>107</u>	<u>929.34</u>	<u>134</u>	<u>929.78</u>	<u>93</u>	<u>930.49</u>	<u>130</u>	<u>933.78</u>	<u>119</u>
920.66	<u>137</u>	<u>924.86</u>	<u>107</u>	<u>929.35</u>	<u>134</u>	<u>929.79</u>	<u>93</u>	<u>930.50</u>	<u>130</u>	<u>933.79</u>	<u>119</u>
920.68	<u>136</u>	<u>924.87</u>	<u>107</u>	<u>929.36</u>	<u>134</u>	<u>929.80</u>	<u>93</u>	<u>930.51</u>	<u>130</u>	<u>933.80</u>	<u>119</u>
920.70	<u>137</u>	<u>924.88</u>	<u>107</u>	<u>929.37</u>	<u>134</u>	<u>929.81</u>	<u>93</u>	<u>930.52</u>	<u>130</u>	<u>933.81</u>	<u>119</u>
920.71	<u>137</u>	<u>924.89</u>	<u>107</u>	<u>929.38</u>	<u>134</u>	<u>929.82</u>	<u>93</u>	<u>930.53</u>	<u>130</u>	<u>933.82</u>	<u>119</u>
920.72	<u>137</u>	<u>924.90</u>	<u>107</u>	<u>929.39</u>	<u>134</u>	<u>929.83</u>	<u>93</u>	<u>930.54</u>	<u>130</u>	<u>933.83</u>	<u>119</u>
920.74	<u>136</u>	<u>924.91</u>	<u>271</u>	<u>929.40</u>	<u>134</u>	<u>929.84</u>	<u>93</u>	<u>930.55</u>	<u>130</u>	<u>933.84</u>	<u>119</u>
920.76	<u>137</u>	<u>924.92</u>	<u>271</u>	<u>929.43</u>	<u>135</u>	<u>929.85</u>	<u>110</u>	<u>930.56</u>	<u>130</u>	<u>933.85</u>	<u>119</u>
920.77	<u>137</u>	<u>924.93</u>	<u>271</u>	<u>929.44</u>	<u>135</u>	<u>929.86</u>	<u>110</u>	<u>930.57</u>	<u>130</u>	<u>933.86</u>	<u>122</u>
920.78	<u>137</u>	<u>924.94</u>	<u>271</u>	<u>929.45</u>	<u>135</u>	<u>929.89</u>	<u>131</u>	<u>930.58</u>	<u>130</u>	<u>933.87</u>	<u>122</u>
920.80	<u>136</u>	<u>924.95</u>	<u>271</u>	<u>929.46</u>	<u>135</u>	<u>929.90</u>	<u>131</u>	<u>930.59</u>	<u>130</u>	<u>933.88</u>	<u>110</u>
923.87	<u>125</u>	<u>924.96</u>	<u>141</u>	<u>929.47</u>	<u>135</u>	<u>929.91</u>	<u>131</u>	<u>930.60</u>	<u>130</u>	<u>933.89</u>	<u>110</u>
923.88	<u>125</u>	<u>924.97</u>	<u>141</u>	<u>929.48</u>	<u>135</u>	<u>929.92</u>	<u>131</u>	<u>930.61</u>	<u>126</u>	<u>933.90</u>	<u>111</u>
923.89	<u>125</u>	<u>924.98</u>	<u>142</u>	<u>929.49</u>	<u>135</u>	<u>929.93</u>	<u>131</u>	<u>930.62</u>	<u>126</u>	<u>933.91</u>	<u>111</u>
923.90	<u>125</u>	<u>924.99</u>	<u>142</u>	<u>929.50</u>	<u>135</u>	<u>929.94</u>	<u>131</u>	<u>930.63</u>	<u>126</u>	<u>933.92</u>	<u>112</u>
923.91	<u>125</u>	<u>92471</u>	<u>118</u>	<u>929.51</u>	<u>135</u>	<u>930.31</u>	<u>129</u>	<u>930.64</u>	<u>126</u>	<u>933.93</u>	<u>112</u>
923.92	<u>125</u>	<u>925.35</u>	<u>123</u>	<u>929.52</u>	<u>135</u>	<u>930.32</u>	<u>129</u>	<u>930.65</u>	<u>126</u>	<u>933.99</u>	<u>111</u>
923.93	<u>125</u>	<u>925.43</u>	<u>123</u>	<u>929.53</u>	<u>135</u>	<u>930.33</u>	<u>129</u>	<u>930.66</u>	<u>126</u>	<u>934.00</u>	<u>111</u>
923.94	<u>125</u>	<u>928.97</u>	<u>98</u>	<u>929.54</u>	<u>135</u>	<u>930.34</u>	<u>129</u>	<u>930.67</u>	<u>126</u>	<u>934.01</u>	<u>120</u>
923.95	<u>125</u>	<u>928.98</u>	<u>98</u>	<u>929.58</u>	<u>103</u>	<u>930.35</u>	<u>129</u>	<u>930.68</u>	<u>126</u>	<u>934.02</u>	<u>120</u>
923.96	<u>125</u>	<u>928.99</u>	<u>98</u>	<u>929.59</u>	<u>103</u>	<u>930.36</u>	<u>129</u>	<u>930.69</u>	<u>117</u>	<u>934.03</u>	<u>120</u>
923.97	<u>125</u>	<u>929.00</u>	<u>98</u>	<u>929.61</u>	<u>103</u>	<u>930.37</u>	<u>129</u>	<u>930.70</u>	<u>117</u>	<u>934.04</u>	<u>120</u>



											
<u>934.05</u>	<u>120</u>	<u>934.38</u>	<u>92</u>	<u>934.71</u>	<u>92</u>	<u>935.61</u>	<u>290</u>	<u>936.85</u>	<u>102</u>	<u>938.79</u>	<u>96</u>
<u>934.06</u>	<u>120</u>	<u>934.39</u>	<u>93</u>	<u>934.72</u>	<u>92</u>	<u>935.62</u>	<u>290</u>	<u>936.86</u>	<u>102</u>	<u>938.80</u>	<u>96</u>
<u>934.07</u>	<u>120</u>	<u>934.40</u>	<u>93</u>	<u>934.73</u>	<u>92</u>	<u>935.63</u>	<u>292</u>	<u>936.89</u>	<u>325</u>	<u>938.81</u>	<u>101</u>
<u>934.08</u>	<u>120</u>	<u>934.41</u>	<u>93</u>	<u>934.74</u>	<u>92</u>	<u>935.64</u>	<u>291</u>	<u>936.92</u>	<u>327</u>	<u>938.82</u>	<u>101</u>
<u>934.09</u>	<u>120</u>	<u>934.42</u>	<u>93</u>	<u>934.75</u>	<u>93</u>	<u>935.67</u>	<u>292</u>	<u>936.94</u>	<u>329</u>	<u>938.83</u>	<u>101</u>
<u>934.10</u>	<u>120</u>	<u>934.43</u>	<u>93</u>	<u>934.76</u>	<u>93</u>	<u>935.72</u>	<u>293</u>	<u>936.95</u>	<u>329</u>	<u>938.95</u>	<u>97</u>
<u>934.11</u>	<u>91</u>	<u>934.44</u>	<u>93</u>	<u>934.77</u>	<u>93</u>	<u>935.83</u>	<u>291</u>	<u>936.96</u>	<u>325</u>	<u>939.00</u>	<u>97</u>
<u>934.12</u>	<u>91</u>	<u>934.45</u>	<u>93</u>	<u>934.78</u>	<u>93</u>	<u>935.86</u>	<u>294</u>	<u>936.97</u>	<u>328</u>	<u>939.01</u>	<u>97</u>
<u>934.13</u>	<u>91</u>	<u>934.46</u>	<u>94</u>	<u>934.79</u>	<u>93</u>	<u>936.31</u>	<u>112</u>	<u>937.30</u>	<u>116</u>	<u>939.02</u>	<u>96</u>
<u>934.14</u>	<u>91</u>	<u>934.47</u>	<u>94</u>	<u>934.80</u>	<u>93</u>	<u>936.32</u>	<u>112</u>	<u>937.31</u>	<u>116</u>	<u>939.03</u>	<u>96</u>
<u>934.15</u>	<u>121</u>	<u>934.48</u>	<u>94</u>	<u>934.81</u>	<u>93</u>	<u>936.33</u>	<u>112</u>	<u>937.40</u>	<u>138</u>	<u>939.04</u>	<u>345</u>
<u>934.16</u>	<u>121</u>	<u>934.49</u>	<u>94</u>	<u>934.82</u>	<u>94</u>	<u>936.39</u>	<u>113</u>	<u>937.41</u>	<u>138</u>	<u>939.07</u>	<u>332</u>
<u>934.17</u>	<u>121</u>	<u>934.50</u>	<u>94</u>	<u>934.83</u>	<u>94</u>	<u>936.40</u>	<u>113</u>	<u>937.42</u>	<u>138</u>	<u>939.08</u>	<u>332</u>
<u>934.18</u>	<u>121</u>	<u>934.51</u>	<u>94</u>	<u>934.84</u>	<u>94</u>	<u>936.41</u>	<u>113</u>	<u>937.43</u>	<u>138</u>	<u>939.17</u>	<u>334</u>
<u>934.19</u>	<u>121</u>	<u>934.52</u>	<u>94</u>	<u>934.85</u>	<u>94</u>	<u>936.61</u>	<u>98</u>	<u>937.51</u>	<u>363</u>	<u>939.20</u>	<u>334</u>
<u>934.20</u>	<u>91</u>	<u>934.53</u>	<u>94</u>	<u>934.86</u>	<u>94</u>	<u>936.62</u>	<u>98</u>	<u>937.61</u>	<u>143</u>	<u>939.21</u>	<u>333</u>
<u>934.21</u>	<u>91</u>	<u>934.54</u>	<u>94</u>	<u>934.87</u>	<u>94</u>	<u>936.63</u>	<u>99</u>	<u>937.62</u>	<u>143</u>	<u>939.22</u>	<u>333</u>
<u>934.22</u>	<u>91</u>	<u>934.55</u>	<u>94</u>	<u>934.88</u>	<u>94</u>	<u>936.64</u>	<u>99</u>	<u>937.64</u>	<u>377</u>	<u>939.26</u>	<u>342</u>
<u>934.23</u>	<u>91</u>	<u>934.56</u>	<u>94</u>	<u>934.89</u>	<u>94</u>	<u>936.70</u>	<u>109</u>	<u>937.65</u>	<u>375</u>	<u>939.27</u>	<u>342</u>
<u>934.24</u>	<u>91</u>	<u>934.57</u>	<u>95</u>	<u>934.90</u>	<u>94</u>	<u>936.71</u>	<u>100</u>	<u>937.74</u>	<u>381</u>	<u>939.28</u>	<u>343</u>
<u>934.25</u>	<u>91</u>	<u>934.58</u>	<u>95</u>	<u>934.91</u>	<u>94</u>	<u>936.72</u>	<u>100</u>	<u>937.75</u>	<u>381</u>	<u>939.29</u>	<u>342</u>
<u>934.26</u>	<u>91</u>	<u>934.59</u>	<u>95</u>	<u>934.92</u>	<u>94</u>	<u>936.73</u>	<u>100</u>	<u>937.88</u>	<u>360</u>	<u>939.30</u>	<u>343</u>
<u>934.27</u>	<u>91</u>	<u>934.60</u>	<u>95</u>	<u>934.93</u>	<u>95</u>	<u>936.74</u>	<u>100</u>	<u>938.10</u>	<u>143</u>	<u>939.31</u>	<u>343</u>
<u>934.28</u>	<u>92</u>	<u>934.61</u>	<u>95</u>	<u>934.94</u>	<u>95</u>	<u>936.75</u>	<u>100</u>	<u>938.69</u>	<u>97</u>	<u>939.34</u>	<u>330</u>
<u>934.29</u>	<u>92</u>	<u>934.62</u>	<u>95</u>	<u>934.95</u>	<u>95</u>	<u>936.76</u>	<u>100</u>	<u>938.70</u>	<u>97</u>	<u>939.49</u>	<u>328</u>
<u>934.30</u>	<u>92</u>	<u>934.63</u>	<u>95</u>	<u>934.96</u>	<u>95</u>	<u>936.77</u>	<u>96</u>	<u>938.71</u>	<u>97</u>	<u>939.51</u>	<u>331</u>
<u>934.31</u>	<u>92</u>	<u>934.64</u>	<u>92</u>	<u>934.97</u>	<u>95</u>	<u>936.78</u>	<u>96</u>	<u>938.72</u>	<u>97</u>	<u>939.53</u>	<u>332</u>
<u>934.32</u>	<u>92</u>	<u>934.65</u>	<u>92</u>	<u>934.98</u>	<u>95</u>	<u>936.79</u>	<u>96</u>	<u>938.73</u>	<u>97</u>	<u>939.92</u>	<u>358</u>
<u>934.33</u>	<u>92</u>	<u>934.66</u>	<u>92</u>	<u>934.99</u>	<u>95</u>	<u>936.80</u>	<u>96</u>	<u>938.74</u>	<u>97</u>	<u>939.93</u>	<u>358</u>
<u>934.34</u>	<u>92</u>	<u>934.67</u>	<u>92</u>	<u>935.52</u>	<u>295</u>	<u>936.81</u>	<u>102</u>	<u>938.75</u>	<u>96</u>	<u>939.94</u>	<u>342</u>
<u>934.35</u>	<u>92</u>	<u>934.68</u>	<u>92</u>	<u>935.53</u>	<u>295</u>	<u>936.82</u>	<u>102</u>	<u>938.76</u>	<u>96</u>	<u>939.97</u>	<u>330</u>
<u>934.36</u>	<u>92</u>	<u>934.69</u>	<u>92</u>	<u>935.54</u>	<u>295</u>	<u>936.83</u>	<u>102</u>	<u>938.77</u>	<u>96</u>	<u>939.99</u>	<u>343</u>
<u>934.37</u>	<u>92</u>	<u>934.70</u>	<u>92</u>	<u>935.55</u>	<u>295</u>	<u>936.84</u>	<u>102</u>	<u>938.78</u>	<u>96</u>	<u>940.80</u>	<u>204</u>



											
<u>941.19</u>	<u>354</u>	<u>942.10</u>	<u>384</u>	<u>942.81</u>	<u>355</u>	<u>943.26</u>	<u>351</u>	<u>944.19</u>	<u>195</u>	<u>944.53</u>	<u>353</u>
<u>941.32</u>	<u>204</u>	<u>942.15</u>	<u>341</u>	<u>942.82</u>	<u>355</u>	<u>943.27</u>	<u>351</u>	<u>944.20</u>	<u>196</u>	<u>944.54</u>	<u>361</u>
<u>941.33</u>	<u>204</u>	<u>942.16</u>	<u>341</u>	<u>942.83</u>	<u>330</u>	<u>943.28</u>	<u>351</u>	<u>944.21</u>	<u>196</u>	<u>944.57</u>	<u>203</u>
<u>941.34</u>	<u>205</u>	<u>942.27</u>	<u>332</u>	<u>942.84</u>	<u>323</u>	<u>943.29</u>	<u>351</u>	<u>944.22</u>	<u>196</u>	<u>944.58</u>	<u>190</u>
<u>941.36</u>	<u>206</u>	<u>942.28</u>	<u>332</u>	<u>942.85</u>	<u>330</u>	<u>943.30</u>	<u>351</u>	<u>944.23</u>	<u>196</u>	<u>944.59</u>	<u>193</u>
<u>941.38</u>	<u>207</u>	<u>942.33</u>	<u>376</u>	<u>942.86</u>	<u>324</u>	<u>943.31</u>	<u>352</u>	<u>944.24</u>	<u>196</u>	<u>944.60</u>	<u>193</u>
<u>941.41</u>	<u>208</u>	<u>942.34</u>	<u>376</u>	<u>942.87</u>	<u>384</u>	<u>943.36</u>	<u>359</u>	<u>944.25</u>	<u>196</u>	<u>944.61</u>	<u>193</u>
<u>941.44</u>	<u>205</u>	<u>942.38</u>	<u>380</u>	<u>942.88</u>	<u>384</u>	<u>943.37</u>	<u>359</u>	<u>944.26</u>	<u>197</u>	<u>944.62</u>	<u>193</u>
<u>941.45</u>	<u>206</u>	<u>942.39</u>	<u>380</u>	<u>942.90</u>	<u>205</u>	<u>943.38</u>	<u>367</u>	<u>944.27</u>	<u>197</u>	<u>944.63</u>	<u>193</u>
<u>941.46</u>	<u>207</u>	<u>942.41</u>	<u>330</u>	<u>942.91</u>	<u>205</u>	<u>943.39</u>	<u>367</u>	<u>944.28</u>	<u>201</u>	<u>944.64</u>	<u>193</u>
<u>941.47</u>	<u>207</u>	<u>942.42</u>	<u>323</u>	<u>942.92</u>	<u>104</u>	<u>943.40</u>	<u>367</u>	<u>944.29</u>	<u>201</u>	<u>944.65</u>	<u>191</u>
<u>941.48</u>	<u>205</u>	<u>942.43</u>	<u>369</u>	<u>942.93</u>	<u>104</u>	<u>943.41</u>	<u>367</u>	<u>944.30</u>	<u>188</u>	<u>944.66</u>	<u>191</u>
<u>941.53</u>	<u>205</u>	<u>942.45</u>	<u>368</u>	<u>942.94</u>	<u>104</u>	<u>943.63</u>	<u>358</u>	<u>944.31</u>	<u>188</u>	<u>944.67</u>	<u>191</u>
<u>941.54</u>	<u>326</u>	<u>942.46</u>	<u>372</u>	<u>942.95</u>	<u>104</u>	<u>943.64</u>	<u>358</u>	<u>944.32</u>	<u>188</u>	<u>944.68</u>	<u>191</u>
<u>941.56</u>	<u>326</u>	<u>942.47</u>	<u>372</u>	<u>942.96</u>	<u>104</u>	<u>943.65</u>	<u>358</u>	<u>944.33</u>	<u>188</u>	<u>944.69</u>	<u>191</u>
<u>941.65</u>	<u>340</u>	<u>942.49</u>	<u>377</u>	<u>942.97</u>	<u>104</u>	<u>943.66</u>	<u>358</u>	<u>944.34</u>	<u>188</u>	<u>944.70</u>	<u>191</u>
<u>941.66</u>	<u>385</u>	<u>942.50</u>	<u>370</u>	<u>942.98</u>	<u>104</u>	<u>943.82</u>	<u>357</u>	<u>944.35</u>	<u>188</u>	<u>944.71</u>	<u>94</u>
<u>941.69</u>	<u>385</u>	<u>942.51</u>	<u>370</u>	<u>942.99</u>	<u>104</u>	<u>943.83</u>	<u>357</u>	<u>944.36</u>	<u>189</u>	<u>944.72</u>	<u>94</u>
<u>941.75</u>	<u>339</u>	<u>942.52</u>	<u>379</u>	<u>943.00</u>	<u>104</u>	<u>943.84</u>	<u>361</u>	<u>944.37</u>	<u>189</u>	<u>944.73</u>	<u>95</u>
<u>941.76</u>	<u>339</u>	<u>942.53</u>	<u>370</u>	<u>943.01</u>	<u>104</u>	<u>943.85</u>	<u>361</u>	<u>944.38</u>	<u>189</u>	<u>944.74</u>	<u>95</u>
<u>941.77</u>	<u>338</u>	<u>942.60</u>	<u>368</u>	<u>943.02</u>	<u>104</u>	<u>943.86</u>	<u>361</u>	<u>944.39</u>	<u>189</u>	<u>944.75</u>	<u>199</u>
<u>941.78</u>	<u>338</u>	<u>942.62</u>	<u>378</u>	<u>943.03</u>	<u>104</u>	<u>943.90</u>	<u>360</u>	<u>944.40</u>	<u>189</u>	<u>944.76</u>	<u>199</u>
<u>941.79</u>	<u>338</u>	<u>942.63</u>	<u>374</u>	<u>943.04</u>	<u>104</u>	<u>943.91</u>	<u>356</u>	<u>944.41</u>	<u>189</u>	<u>944.77</u>	<u>199</u>
<u>941.80</u>	<u>339</u>	<u>942.64</u>	<u>372</u>	<u>943.05</u>	<u>104</u>	<u>943.92</u>	<u>356</u>	<u>944.42</u>	<u>190</u>	<u>944.78</u>	<u>199</u>
<u>941.81</u>	<u>339</u>	<u>942.65</u>	<u>373</u>	<u>943.06</u>	<u>118</u>	<u>943.93</u>	<u>362</u>	<u>944.43</u>	<u>190</u>	<u>944.79</u>	<u>199</u>
<u>941.84</u>	<u>339</u>	<u>942.67</u>	<u>384</u>	<u>943.09</u>	<u>366</u>	<u>943.96</u>	<u>355</u>	<u>944.45</u>	<u>190</u>	<u>944.80</u>	<u>199</u>
<u>941.85</u>	<u>339</u>	<u>942.68</u>	<u>338</u>	<u>943.10</u>	<u>374</u>	<u>943.97</u>	<u>362</u>	<u>944.46</u>	<u>190</u>	<u>944.81</u>	<u>200</u>
<u>941.86</u>	<u>356</u>	<u>942.69</u>	<u>338</u>	<u>943.11</u>	<u>374</u>	<u>943.98</u>	<u>355</u>	<u>944.47</u>	<u>190</u>	<u>944.82</u>	<u>200</u>
<u>941.87</u>	<u>354</u>	<u>942.74</u>	<u>331</u>	<u>943.12</u>	<u>335</u>	<u>944.14</u>	<u>195</u>	<u>944.48</u>	<u>192</u>	<u>944.83</u>	<u>200</u>
<u>941.88</u>	<u>354</u>	<u>942.75</u>	<u>327</u>	<u>943.21</u>	<u>335</u>	<u>944.15</u>	<u>195</u>	<u>944.49</u>	<u>192</u>	<u>944.84</u>	<u>200</u>
<u>941.91</u>	<u>341</u>	<u>942.78</u>	<u>368</u>	<u>943.22</u>	<u>336</u>	<u>944.16</u>	<u>195</u>	<u>944.50</u>	<u>192</u>	<u>944.85</u>	<u>200</u>
<u>942.08</u>	<u>385</u>	<u>942.79</u>	<u>370</u>	<u>943.23</u>	<u>336</u>	<u>944.17</u>	<u>195</u>	<u>944.51</u>	<u>192</u>	<u>944.86</u>	<u>200</u>
<u>942.09</u>	<u>331</u>	<u>942.80</u>	<u>379</u>	<u>943.25</u>	<u>351</u>	<u>944.18</u>	<u>195</u>	<u>944.52</u>	<u>353</u>	<u>944.87</u>	<u>194</u>

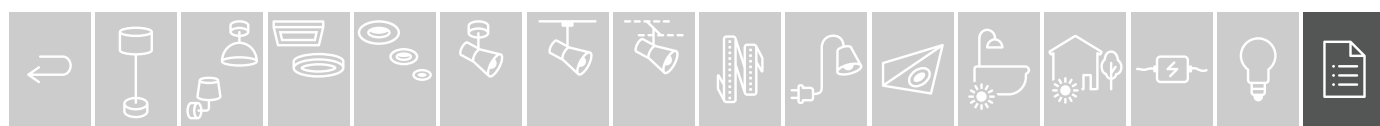

<u>944.88</u>	<u>194</u>	<u>945.79</u>	<u>348</u>	<u>953.20</u>	<u>166</u>	<u>953.87</u>	<u>128</u>	<u>954.57</u>	<u>169</u>	<u>955.11</u>	<u>156</u>
<u>944.89</u>	<u>194</u>	<u>945.80</u>	<u>348</u>	<u>953.25</u>	<u>179</u>	<u>953.88</u>	<u>374</u>	<u>954.58</u>	<u>169</u>	<u>955.19</u>	<u>155</u>
<u>944.90</u>	<u>189</u>	<u>945.81</u>	<u>348</u>	<u>953.26</u>	<u>179</u>	<u>953.89</u>	<u>133</u>	<u>954.59</u>	<u>164</u>	<u>955.20</u>	<u>168</u>
<u>944.92</u>	<u>189</u>	<u>945.82</u>	<u>348</u>	<u>953.27</u>	<u>179</u>	<u>953.90</u>	<u>133</u>	<u>954.61</u>	<u>164</u>	<u>955.25</u>	<u>162</u>
<u>944.94</u>	<u>189</u>	<u>945.83</u>	<u>348</u>	<u>953.29</u>	<u>163</u>	<u>953.91</u>	<u>133</u>	<u>954.62</u>	<u>164</u>	<u>955.26</u>	<u>162</u>
<u>944.96</u>	<u>201</u>	<u>945.84</u>	<u>348</u>	<u>953.30</u>	<u>163</u>	<u>953.92</u>	<u>133</u>	<u>954.63</u>	<u>163</u>	<u>955.51</u>	<u>182</u>
<u>945.04</u>	<u>359</u>	<u>945.85</u>	<u>347</u>	<u>953.31</u>	<u>163</u>	<u>953.93</u>	<u>366</u>	<u>954.65</u>	<u>173</u>	<u>955.52</u>	<u>182</u>
<u>945.05</u>	<u>371</u>	<u>945.86</u>	<u>347</u>	<u>953.33</u>	<u>163</u>	<u>953.95</u>	<u>155</u>	<u>954.66</u>	<u>173</u>	<u>955.53</u>	<u>182</u>
<u>945.10</u>	<u>347</u>	<u>945.89</u>	<u>201</u>	<u>953.35</u>	<u>164</u>	<u>954.15</u>	<u>178</u>	<u>954.69</u>	<u>154</u>	<u>955.56</u>	<u>275</u>
<u>945.18</u>	<u>347</u>	<u>945.91</u>	<u>201</u>	<u>953.36</u>	<u>164</u>	<u>954.16</u>	<u>180</u>	<u>954.71</u>	<u>157</u>	<u>955.57</u>	<u>275</u>
<u>945.30</u>	<u>337</u>	<u>945.93</u>	<u>201</u>	<u>953.37</u>	<u>165</u>	<u>954.17</u>	<u>180</u>	<u>954.73</u>	<u>157</u>	<u>955.58</u>	<u>275</u>
<u>945.33</u>	<u>337</u>	<u>946.66</u>	<u>376</u>	<u>953.38</u>	<u>165</u>	<u>954.18</u>	<u>180</u>	<u>954.74</u>	<u>157</u>	<u>955.59</u>	<u>275</u>
<u>945.36</u>	<u>337</u>	<u>949.71</u>	<u>168</u>	<u>953.39</u>	<u>165</u>	<u>954.23</u>	<u>269</u>	<u>954.77</u>	<u>174</u>	<u>955.60</u>	<u>275</u>
<u>945.37</u>	<u>337</u>	<u>949.72</u>	<u>168</u>	<u>953.42</u>	<u>165</u>	<u>954.24</u>	<u>269</u>	<u>954.78</u>	<u>174</u>	<u>955.61</u>	<u>275</u>
<u>945.50</u>	<u>349</u>	<u>949.73</u>	<u>167</u>	<u>953.43</u>	<u>165</u>	<u>954.25</u>	<u>273</u>	<u>954.79</u>	<u>174</u>	<u>955.62</u>	<u>276</u>
<u>945.51</u>	<u>348</u>	<u>949.74</u>	<u>167</u>	<u>953.44</u>	<u>165</u>	<u>954.26</u>	<u>273</u>	<u>954.80</u>	<u>174</u>	<u>955.64</u>	<u>276</u>
<u>945.52</u>	<u>348</u>	<u>949.75</u>	<u>167</u>	<u>953.51</u>	<u>173</u>	<u>954.27</u>	<u>274</u>	<u>954.83</u>	<u>175</u>	<u>955.66</u>	<u>276</u>
<u>945.55</u>	<u>349</u>	<u>949.79</u>	<u>154</u>	<u>953.52</u>	<u>173</u>	<u>954.28</u>	<u>274</u>	<u>954.85</u>	<u>175</u>	<u>955.68</u>	<u>277</u>
<u>945.56</u>	<u>349</u>	<u>949.98</u>	<u>170</u>	<u>953.54</u>	<u>173</u>	<u>954.29</u>	<u>274</u>	<u>954.86</u>	<u>175</u>	<u>955.69</u>	<u>277</u>
<u>945.57</u>	<u>340</u>	<u>950.16</u>	<u>177</u>	<u>953.57</u>	<u>153</u>	<u>954.30</u>	<u>272</u>	<u>954.92</u>	<u>173</u>	<u>955.70</u>	<u>277</u>
<u>945.58</u>	<u>340</u>	<u>950.86</u>	<u>178</u>	<u>953.58</u>	<u>153</u>	<u>954.31</u>	<u>272</u>	<u>954.93</u>	<u>153</u>	<u>955.71</u>	<u>277</u>
<u>945.60</u>	<u>341</u>	<u>951.26</u>	<u>178</u>	<u>953.59</u>	<u>153</u>	<u>954.32</u>	<u>272</u>	<u>954.94</u>	<u>182</u>	<u>955.72</u>	<u>277</u>
<u>945.61</u>	<u>341</u>	<u>951.36</u>	<u>179</u>	<u>953.62</u>	<u>161</u>	<u>954.36</u>	<u>172</u>	<u>954.95</u>	<u>182</u>	<u>955.73</u>	<u>277</u>
<u>945.62</u>	<u>341</u>	<u>951.40</u>	<u>179</u>	<u>953.63</u>	<u>161</u>	<u>954.37</u>	<u>172</u>	<u>954.96</u>	<u>178</u>	<u>968.15</u>	<u>183</u>
<u>945.70</u>	<u>371</u>	<u>951.49</u>	<u>178</u>	<u>953.73</u>	<u>155</u>	<u>954.38</u>	<u>173</u>	<u>954.97</u>	<u>178</u>	<u>968.19</u>	<u>183</u>
<u>945.71</u>	<u>371</u>	<u>951.77</u>	<u>169</u>	<u>953.74</u>	<u>155</u>	<u>954.40</u>	<u>173</u>	<u>954.98</u>	<u>178</u>	<u>968.20</u>	<u>177</u>
<u>945.72</u>	<u>373</u>	<u>952.69</u>	<u>159</u>	<u>953.79</u>	<u>127</u>	<u>954.42</u>	<u>173</u>	<u>955.01</u>	<u>166</u>	<u>968.21</u>	<u>177</u>
<u>945.73</u>	<u>378</u>	<u>952.70</u>	<u>159</u>	<u>953.80</u>	<u>127</u>	<u>954.44</u>	<u>173</u>	<u>955.02</u>	<u>166</u>	<u>968.22</u>	<u>177</u>
<u>945.74</u>	<u>331</u>	<u>952.71</u>	<u>159</u>	<u>953.81</u>	<u>127</u>	<u>954.45</u>	<u>173</u>	<u>955.06</u>	<u>160</u>	<u>968.31</u>	<u>180</u>
<u>945.75</u>	<u>331</u>	<u>952.72</u>	<u>159</u>	<u>953.82</u>	<u>127</u>	<u>954.46</u>	<u>155</u>	<u>955.07</u>	<u>160</u>	<u>968.33</u>	<u>178</u>
<u>945.76</u>	<u>382</u>	<u>952.73</u>	<u>160</u>	<u>953.84</u>	<u>128</u>	<u>954.47</u>	<u>155</u>	<u>955.08</u>	<u>160</u>	<u>968.34</u>	<u>178</u>
<u>945.77</u>	<u>375</u>	<u>952.83</u>	<u>160</u>	<u>953.85</u>	<u>128</u>	<u>954.55</u>	<u>157</u>	<u>955.09</u>	<u>160</u>	<u>968.54</u>	<u>178</u>
<u>945.78</u>	<u>382</u>	<u>953.19</u>	<u>166</u>	<u>953.86</u>	<u>128</u>	<u>954.56</u>	<u>157</u>	<u>955.10</u>	<u>156</u>	<u>968.85</u>	<u>180</u>



<u>968.86</u>	<u>180</u>	<u>969.40</u>	<u>160</u>	<u>976.79</u>	<u>180</u>	<u>979.32</u>	<u>389</u>	<u>998.95</u>	<u>279</u>	<u>999.54</u>	<u>285</u>
<u>968.91</u>	<u>157</u>	<u>969.41</u>	<u>156</u>	<u>976.82</u>	<u>178</u>	<u>984.02</u>	<u>296</u>	<u>998.96</u>	<u>279</u>	<u>999.55</u>	<u>285</u>
<u>968.93</u>	<u>183</u>	<u>969.42</u>	<u>155</u>	<u>976.83</u>	<u>178</u>	<u>984.07</u>	<u>296</u>	<u>999.05</u>	<u>314</u>	<u>999.56</u>	<u>288</u>
<u>969.02</u>	<u>178</u>	<u>969.58</u>	<u>170</u>	<u>976.84</u>	<u>178</u>	<u>984.32</u>	<u>297</u>	<u>999.20</u>	<u>294</u>	<u>999.57</u>	<u>288</u>
<u>969.03</u>	<u>178</u>	<u>969.60</u>	<u>180</u>	<u>976.85</u>	<u>180</u>	<u>984.49</u>	<u>297</u>	<u>999.21</u>	<u>294</u>	<u>999.58</u>	<u>288</u>
<u>969.04</u>	<u>178</u>	<u>969.61</u>	<u>178</u>	<u>976.86</u>	<u>179</u>	<u>984.62</u>	<u>297</u>	<u>999.22</u>	<u>108</u>	<u>999.59</u>	<u>288</u>
<u>969.05</u>	<u>178</u>	<u>969.62</u>	<u>161</u>	<u>976.87</u>	<u>179</u>	<u>984.66</u>	<u>296</u>	<u>999.23</u>	<u>108</u>	<u>999.60</u>	<u>285</u>
<u>969.06</u>	<u>179</u>	<u>969.63</u>	<u>161</u>	<u>976.88</u>	<u>178</u>	<u>984.74</u>	<u>297</u>	<u>999.24</u>	<u>108</u>	<u>999.61</u>	<u>285</u>
<u>969.07</u>	<u>179</u>	<u>969.64</u>	<u>179</u>	<u>977.01</u>	<u>388</u>	<u>987.73</u>	<u>115</u>	<u>999.25</u>	<u>108</u>	<u>999.62</u>	<u>286</u>
<u>969.08</u>	<u>179</u>	<u>969.65</u>	<u>179</u>	<u>977.15</u>	<u>388</u>	<u>988.48</u>	<u>345</u>	<u>999.26</u>	<u>108</u>	<u>999.63</u>	<u>286</u>
<u>969.09</u>	<u>179</u>	<u>969.66</u>	<u>165</u>	<u>977.25</u>	<u>388</u>	<u>988.49</u>	<u>345</u>	<u>999.27</u>	<u>108</u>	<u>999.64</u>	<u>286</u>
<u>969.10</u>	<u>179</u>	<u>969.67</u>	<u>165</u>	<u>977.28</u>	<u>387</u>	<u>988.50</u>	<u>345</u>	<u>999.28</u>	<u>108</u>	<u>999.65</u>	<u>286</u>
<u>969.11</u>	<u>163</u>	<u>969.68</u>	<u>152</u>	<u>977.29</u>	<u>387</u>	<u>988.78</u>	<u>116</u>	<u>999.29</u>	<u>108</u>	<u>999.66</u>	<u>286</u>
<u>969.12</u>	<u>152</u>	<u>969.69</u>	<u>152</u>	<u>977.38</u>	<u>391</u>	<u>988.96</u>	<u>363</u>	<u>999.30</u>	<u>108</u>	<u>999.67</u>	<u>286</u>
<u>969.13</u>	<u>152</u>	<u>969.70</u>	<u>152</u>	<u>977.51</u>	<u>387</u>	<u>988.97</u>	<u>363</u>	<u>999.31</u>	<u>108</u>	<u>999.68</u>	<u>287</u>
<u>969.14</u>	<u>182</u>	<u>969.71</u>	<u>152</u>	<u>977.53</u>	<u>387</u>	<u>989.40</u>	<u>116</u>	<u>999.32</u>	<u>108</u>	<u>999.69</u>	<u>287</u>
<u>969.15</u>	<u>158</u>	<u>969.72</u>	<u>171</u>	<u>977.62</u>	<u>389</u>	<u>989.43</u>	<u>116</u>	<u>999.33</u>	<u>108</u>	<u>999.70</u>	<u>287</u>
<u>969.16</u>	<u>180</u>	<u>969.73</u>	<u>171</u>	<u>977.63</u>	<u>390</u>	<u>989.68</u>	<u>114</u>	<u>999.34</u>	<u>109</u>	<u>999.71</u>	<u>287</u>
<u>969.17</u>	<u>160</u>	<u>969.74</u>	<u>171</u>	<u>977.65</u>	<u>181</u>	<u>989.71</u>	<u>114</u>	<u>999.35</u>	<u>109</u>	<u>999.72</u>	<u>284</u>
<u>969.18</u>	<u>161</u>	<u>969.75</u>	<u>170</u>	<u>977.66</u>	<u>181</u>	<u>990.68</u>	<u>313</u>	<u>999.36</u>	<u>109</u>	<u>999.73</u>	<u>282</u>
<u>969.19</u>	<u>172</u>	<u>969.76</u>	<u>170</u>	<u>977.67</u>	<u>389</u>	<u>993.85</u>	<u>313</u>	<u>999.37</u>	<u>109</u>	<u>999.74</u>	<u>283</u>
<u>969.20</u>	<u>166</u>	<u>971.1229</u>	<u>207</u>	<u>977.81</u>	<u>388</u>	<u>994.95</u>	<u>140</u>	<u>999.40</u>	<u>122</u>	<u>999.75</u>	<u>283</u>
<u>969.21</u>	<u>181</u>	<u>972.83</u>	<u>211</u>	<u>977.82</u>	<u>388</u>	<u>996.79</u>	<u>314</u>	<u>999.41</u>	<u>122</u>	<u>999.76</u>	<u>289</u>
<u>969.22</u>	<u>157</u>	<u>974.74</u>	<u>182</u>	<u>978.019</u>	<u>211</u>	<u>996.80</u>	<u>315</u>	<u>999.42</u>	<u>122</u>	<u>999.89</u>	<u>111</u>
<u>969.23</u>	<u>156</u>	<u>975.99</u>	<u>178</u>	<u>978.38</u>	<u>201</u>	<u>998.25</u>	<u>272</u>	<u>999.43</u>	<u>122</u>	<u>999.90</u>	<u>111</u>
<u>969.24</u>	<u>155</u>	<u>976.02</u>	<u>167</u>	<u>978.39</u>	<u>201</u>	<u>998.42</u>	<u>173</u>	<u>999.46</u>	<u>289</u>	<u>999.91</u>	<u>108</u>
<u>969.25</u>	<u>161</u>	<u>976.12</u>	<u>161</u>	<u>978.40</u>	<u>201</u>	<u>998.65</u>	<u>293</u>	<u>999.47</u>	<u>289</u>	<u>999.92</u>	<u>286</u>
<u>969.26</u>	<u>164</u>	<u>976.13</u>	<u>161</u>	<u>978.41</u>	<u>211</u>	<u>998.89</u>	<u>278</u>	<u>999.48</u>	<u>289</u>		
<u>969.27</u>	<u>155</u>	<u>976.48</u>	<u>179</u>	<u>978.45</u>	<u>211</u>	<u>998.90</u>	<u>278</u>	<u>999.49</u>	<u>284</u>		
<u>969.36</u>	<u>157</u>	<u>976.49</u>	<u>179</u>	<u>979.047</u>	<u>210</u>	<u>998.91</u>	<u>278</u>	<u>999.50</u>	<u>284</u>		
<u>969.37</u>	<u>157</u>	<u>976.55</u>	<u>180</u>	<u>979.055</u>	<u>210</u>	<u>998.92</u>	<u>278</u>	<u>999.51</u>	<u>288</u>		
<u>969.38</u>	<u>157</u>	<u>976.56</u>	<u>179</u>	<u>979.057</u>	<u>210</u>	<u>998.93</u>	<u>278</u>	<u>999.52</u>	<u>285</u>		
<u>969.39</u>	<u>158</u>	<u>976.57</u>	<u>179</u>	<u>979.069</u>	<u>210</u>	<u>998.94</u>	<u>279</u>	<u>999.53</u>	<u>285</u>		

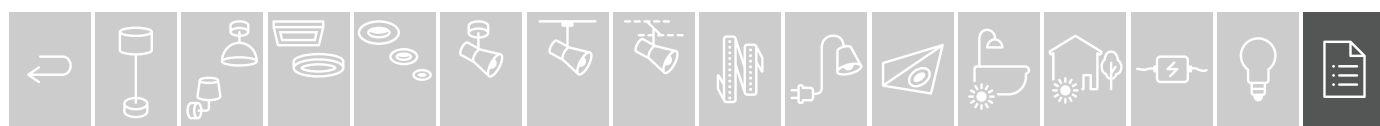

**A****ÖSTERREICH**

Paulmann Ges.m.b.H  
Linzerstrasse 89-91  
A-3003 Gablitz  
☎ +43 2231 66492  
✉ +43 2231 6649217  
info@paulmann.at

**AND****ANDORRA**

Paulmann Licht GmbH  
Quezinger Feld 2  
31832 Springe Völkxen  
☎ +49 5041 998-0  
✉ +49 5041 998-119  
info@paulmann.de

**B****BELGIË**

VSA  
Hagelberg 29  
B-2440 Geel  
☎ +31 499 551460  
✉ +31 499 575795  
Paulmann@vanspijck.nl

**BG****БЪЛГАРИЯ**

Mankovski Ltd.  
3 Pop Dimitar Street  
fl.5 ap. 26  
9000 Varna  
☎ +359 886654093  
i\_mankovski@abv.bg

**BIH****BOSNIA-HERCEGOVINA**

Mikrut D.O.O.  
Maciej Mikrut  
Ulica Ivana Pengova 18  
SI- 1230 Domzale  
☎ +386 31518153  
✉ +386 17219514  
mmikrut@paulmann.si

**CH****SCHWEIZ**

Puag AG  
Oberebenestrasse 51  
CH-5620 Bremgarten  
☎ +41 56 648 88 48  
✉ +41 56 648 88 80  
paulmann@puag.ch

**CY****ΚΥΠΡΟΣ**

Paulmann Licht GmbH  
Quezinger Feld 2  
31832 Springe Völkxen  
☎ +49 5041 998-0  
✉ +49 5041 998-119  
info@paulmann.de

**CZ****ČESKÁ REPUBLIKA**

Ing. Radek Brada  
Náměstí Na Sádkách 705  
25241 Dolní Břežany  
☎ +420 602331140  
✉ +420 241416267  
brada.radek@volny.cz

AULIX lighting spol. s r.o.  
Náměstí Na Sádkách 705  
252 41 Dolní Břežany  
Mobil: +420 702 053 063  
Tel.: +420 241 402 565  
E-mail: info@aulix.cz  
Czech republic

**D****DEUTSCHLAND**

Paulmann Licht GmbH  
Quezinger Feld 2  
31832 Springe Völkxen  
☎ +49 5041 998-0  
✉ +49 5041 998-119  
info@paulmann.de

**DK****DANMARK**

SB Butiksservice  
Radhustorvet 11  
DK-8700 Horsens  
☎ +45 7023 2730  
✉ +49 7023 2703  
mb@sb.dk

**E****ESPAÑA**

Paulmann Licht GmbH  
Quezinger Feld 2  
31832 Springe Völkxen  
☎ +49 5041 998-0  
✉ +49 5041 998-119  
info@paulmann.de

**EST****EESTI**

SIA Paulmann-Gaisma  
Gertrudes lela 53-1A  
LV- 1011 Riga  
☎ +371 67280542  
✉ +371 67542413  
Paulmann@latnet.lv

**F****FRANCE**

Paulmann Lumière S.A.S.  
21, rue Desaix- CS 21076  
F-67452 Mundolsheim Cedex  
☎ +33 3 90203737  
✉ +33 3 90203757  
comm@paulmann.fr

**FIN****SUOMI (FINLAND)**

Oy Hedtec Ab  
Hedengren Yhtiot  
PL 110  
00201 Helsinki  
☎ +358 2 70 638 000  
valaistus@hedtec.fi

**FL****LIECHTENSTEIN**

Puag AG  
Oberebenestrasse 51  
CH-5620 Bremgarten  
☎ +41/56-6488855  
✉ +41/56-6488850  
info@puag.ch

**GB****UNITED KINGDOM**

Light Source Europe Ltd.  
6 Great Western Business  
Park  
McKenzie Way  
Worcester  
WR4 9PT  
☎ +44 1905 22243  
✉ +44 1905 611263  
sales@lselighting.com

**GR****ΕΛΛΑΔΑ**

Paulmann Licht GmbH  
Quezinger Feld 2  
31832 Springe Völkxen  
☎ +49 5041 998-0  
✉ +49 5041 998-119  
info@paulmann.de

**H****MAGYARORSZÁG**

DINOCOOP GmbH  
Radvány u. 24  
1118 Budapest XI  
☎ +36-1-3193064  
✉ +36-1-3193066  
dinocoop@dinocoop.hu

**HR****HRVATSKA**

Mikrut D.O.O.  
Maciej Mikrut  
Ulica Ivana Pengova 18  
SI- 1230 Domzale  
☎ +386 31518153  
✉ +386 17219514  
mmikrut@paulmann.si

**I****ITALIA**

TreEsse Srl  
Via Gastone Breddo, 8c  
50041 Calenzano  
(Firenze) Italia  
☎ +39 055 4211598  
✉ +39 055 0457871  
elena@treessesrl.com

**IS****ISLAND**

Johann Olafsson & Co  
Krokhals 3  
IS-110 Reykjavik  
☎ +354- 5331904  
✉ +354- 5331901  
jarni@olafsson.is

**L****LUXEMBOURG**

VSA  
Hagelberg 29  
B-2440 Geel  
☎ +31 499 551460  
✉ +31 499 575795  
Paulmann@vanspijck.nl

**LT****LIETUVA**

SIA Paulmann-Gaisma  
Gertrudes lela 53-1A  
LV- 1011 Riga  
☎ +371 67280542  
✉ +371 67542413  
Paulmann@latnet.lv

**LV****LATVIJA**

SIA Paulmann-Gaisma  
Gertrudes lela 53-1A  
LV- 1011 Riga  
☎ +371 67280542  
✉ +371 67542413  
paulmann@latnet.lv

**MK****MAKEDONIJA**

DPTUO „EL-LUKS“ DOOEL  
ul : Leninova br. 79  
MK-2400 Strumica  
☎ +389 75 301 109  
✉ +389 34 320 133  
info@el-lux.com.mk

**MNE****CRNA GORA**

Mikrut D.O.O.  
Maciej Mikrut  
Ulica Ivana Pengova 18  
SI- 1230 Domzale  
☎ +386 31518153  
✉ +386 172 19514  
mmikrut@paulmann.si

**N****NORGE**

Lyskomponenter AS  
Sagmyra 2A  
N-4624 Kristiansand S  
☎ +47 38003636  
✉ +47 38003639  
firmapost@lyskomponenter.no

**NL****NEDERLAND**

VSA  
De Scheper 402  
NL-5688HP Oirschot  
☎ +31 499 551460  
✉ +31 499 575795  
Paulmann@vanspijck.nl

**P****PORTUGAL**

Paulmann Licht GmbH  
Quezinger Feld 2  
31832 Springe Völkxen  
☎ +49 5041 998-0  
✉ +49 5041 998-119  
info@paulmann.de

**PL****POLSKA**

“LŁ” Spółka z ograniczoną  
odpowiedzialnością sp. k.  
ul. Wrocławska 43 Byków;  
55-095 Mirków  
☎ +48 71 39 80 800  
✉ +48 71 39 80 802  
paulmann@langelukaszuk.pl

**RO****ROMANIA**

Atrium Design SRL  
Str. Balciului, no.1  
Sector 2,  
RO-021501 Bucharest  
☎ +40 21 252 4653  
✉ +40 21 252 4654  
atrium@atrium.ro

**RUS****РОССИЯ**

Лайт Капитал 000  
ул.Выборгская д.16  
стр.1 оф.А809  
125212, г.Москва  
☎ +7 495 514-19-08  
✉ +7 495 514-19-08  
info@paulmann.ru

**S****SVERIGE**

Paulmann Licht GmbH  
Quezinger Feld 2  
D-31832 Springe  
☎ +49 5041 998-0  
✉ +49 5041 998-169  
info@paulmann.de

**SK****SLOVAKIA**

Ing. Radek Brada  
Náměstí Na Sádkách 705  
25241 Dolní Břežany  
☎ +420 602331140  
✉ +420 241416267  
brada.radek@volny.cz

AULIX lighting spol. s r.o.  
Náměstí Na Sádkách 705  
252 41 Dolní Břežany  
Mobil: +420 702 053 063  
Tel.: +420 241 402 565  
E-mail: info@aulix.cz  
Czech republic

**SLO****SLOVENIJA**

Mikrut D.O.O.  
Maciej Mikrut  
Ulica Ivana Pengova 18  
SI- 1230 Domzale  
☎ +386 31518153  
✉ +386 172 19514  
mmikrut@paulmann.si

**SRB****REPUBLIKA SRBIJA**

Mikrut D.O.O.  
Maciej Mikrut  
Ulica Ivana Pengova 18  
SI- 1230 Domzale  
☎ +386 31518153  
✉ +386 172 19514  
mmikrut@paulmann.si

**TR****TÜRKIYE**

Paulmann Licht GmbH  
Quezinger Feld 2  
D-31832 Springe  
☎ +49 5041 998-0  
✉ +49 5041 998-169  
info@paulmann.de

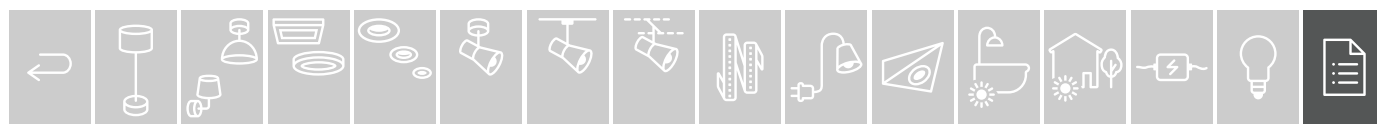

Product dimensions  
 Dimensionado de artículos  
 Dimensionamento degli articoli

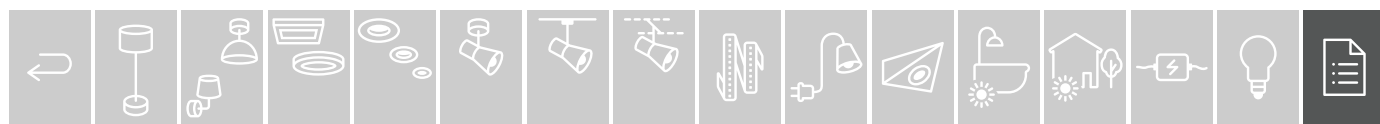
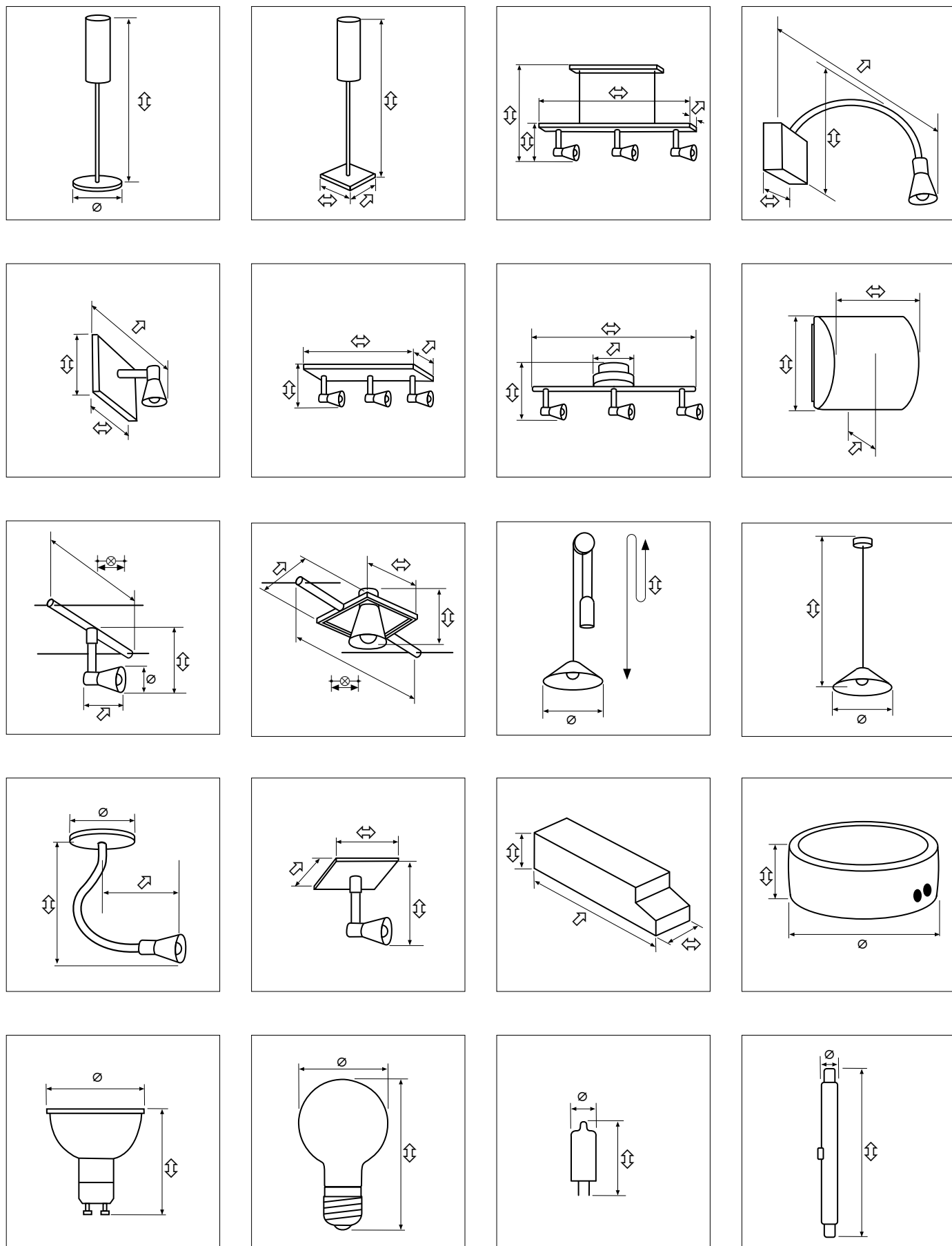



**GB**  
**Warranty conditions of Paulmann Licht GmbH**

Paulmann Licht GmbH guarantees non-commercial customers that products marked with a corresponding warranty mark will function flawlessly for a period of 5 years from the date of purchase. Our full warranty terms and conditions can be found on our website: [www.paulmann.com/guarantee](http://www.paulmann.com/guarantee)

All illustrations and specifications regarding measurements, colours and the like may be subject to technical production margins of tolerance, and are not binding. We reserve the right to make changes to products at any time. We work on the basis of our Terms of Supply and Payment. We will be happy to supply these terms on request, or they can be viewed at [www.paulmann.com](http://www.paulmann.com).

Safety test marks issued by the Association of German Electrical Technicians (VDE) and the German Technical Monitoring Associations (TÜV). Paulmann is synonymous with optimum safety and quality. All our products comply with the European standards laid down. Even when safety tests are not mandatory, Paulmann products are tested by the VDE, TÜV or the Paulmann Quality Assurance department. These are marked accordingly in the product.

Our products made of natural materials and handmade glass are unique; they are subject to natural fluctuations in colour and structure.

Colour

Material

Safety classification 2

Safety classification 3

Dichroic mirror

Low pressure

Product with a limited surface temperature

The bulb is only suitable for fitting to non-flammable materials.

IP safety classifications  
See page 445 for further details

Rust-proof

Adjustable colours

Flashing

Freeze function

Flashlight function

Sound sensor

With switch

**E**  
**Condiciones de garantía Paulmann Licht GmbH**

Paulmann Licht GmbH garantiza a los clientes no comerciales el perfecto funcionamiento de los productos marcados con un indicador de garantía correspondiente durante un período de tiempo de 5 años a partir de la fecha de la compra. Puede encontrar nuestras condiciones de garantía íntegras en nuestro sitio web: [www.paulmann.com/guarantee](http://www.paulmann.com/guarantee)

Todas las ilustraciones y datos de dimensiones, color, etc. dependen de posibles tolerancias técnicas y de producción y no son vinculantes. Nos reservamos el derecho a modificaciones en los productos. Todo pedido implica la aceptación de nuestras condiciones de pago y suministro. Nos las puede solicitar o ver en [www.paulmann.com](http://www.paulmann.com)

Símbolo de control de seguridad de VDE y TÜV. Paulmann equivale a seguridad y calidad. Todos nuestros artículos están fabricados según las normas europeas fijadas. Los productos de Paulmann se someten a inspección por el VDE, TÜV o control de calidad de Paulmann, incluso cuando no está estipulada. Los artículos están marcados de forma correspondiente en el catálogo.

Nuestros productos de materiales naturales y cristales hechos a mano son únicos, están sujetos a variaciones naturales de color y estructura.

Color

matériau

Clase de protección 2

Clase de protección 3

Reflector dicróico

Baja presión

Producto con temperatura limitada en la superficie

La luminaria sólo debe instalarse en materiales no inflamables.

Clases de protección IP  
Para más información, véase pág. 445

Inoxidable

Colores configurables

Intermitente

Función Freeze

Función Flashlight

Sensor de sonido

Con interruptor

**I**  
**Condizioni di garanzia Paulmann Licht GmbH**

Paulmann Licht GmbH garantisce ai clienti non commerciali il perfetto funzionamento dei prodotti con marchio di garanzia per un periodo di 5 anni a partire dalla data d'acquisto. Le nostre condizioni di garanzia complete sono disponibili sul nostro sito web: [www.paulmann.com/guarantee](http://www.paulmann.com/guarantee)

Le illustrazioni e i dati possono presentare lievi differenze tecniche rispetto ai prodotti (dimensioni, colori, ecc.) e non sono vincolanti. Ci riserviamo di apportare modifiche ai prodotti in qualsiasi momento. La nostra attività si basa sulle nostre condizioni generali di fornitura e pagamento, che sono disponibili su richiesta oppure nel sito Internet [www.paulmann.com](http://www.paulmann.com).

Marchi di sicurezza del Verband Deutscher Elektrotechniker (associazione dei tecnici elettricisti tedeschi) e delle associazioni di controllo tecnico. Paulmann è sinonimo di qualità e massima sicurezza. Tutti i nostri articoli sono conformi alle vigenti normative europee. I prodotti Paulmann sono testati dal VDE, dal TÜV o dalla nostra unità interna di assicurazione qualità, anche nei casi in cui non è prescritto un collaudo di sicurezza obbligatorio. I test effettuati sono specificati nel catalogo.

I nostri prodotti in materiali naturali e vetri realizzati a mano sono unici e naturalmente sono soggetti a variazioni di colore e struttura.

Colore

Materiale

Grado di protezione 2

Grado di protezione 3

Specchio per luce fredda

Bassa pressione

Prodotto con temperatura superficiale limitata

L'apparecchio d'illuminazione è idoneo al solo montaggio su materiali non infiammabili.

Gradi di protezione IP  
Per le spiegazioni vedi pagina 445

Antiruggine

Colori impostabili

Lampeggiante

Funzione freeze







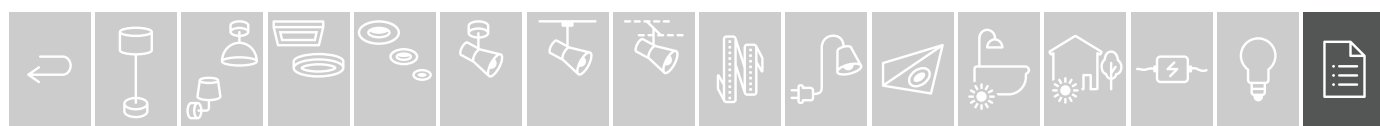
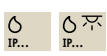















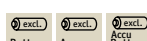

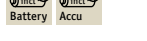



Funzione Flashlight

Sensore di suono









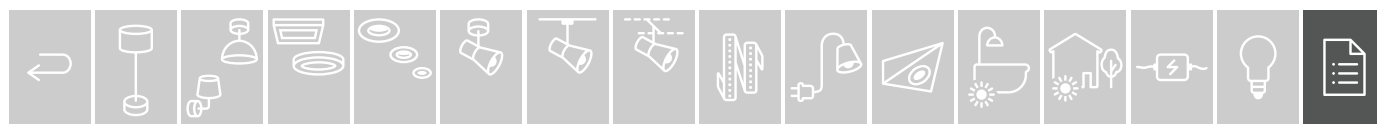







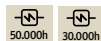











Con interruttore





	With cable switch incl. plug	Con interruptor de cable, enchufe incl.	Completo di interruttore a cavo incl. connettore
	With touch dimmer	Con reguladores de luz táctiles	Con dimmer a sfioramento
	With dimmer	Con reguladores de luz	Con dimmer
	Stepped dimmer	gradualmente más tenue	Dimmer regolabile
	Bayonet coupling	cierre bayoneta	Attacco a baionetta
	With plug-in transformer	Con transformador de enchufe	Con trasformatore a spina
	Plug including earthing contact (Germany)	Enchufe con contacto de puesta a tierra (Alemania)	Connettore Schuko (Germania)
	With plug connector	Con conector	Con connettore a spina
	With remote control	Con mando a distancia	Con telecomando
	Motion detector with high frequency sensor	sensor de movimiento con sensor de alta frecuencia	Sensore di movimento ad alta frequenza
	Motion detector	sensor de movimiento	Sensore di movimento
	Motion detector with proximity sensor	sensor de movimiento con sensor de proximidad	Sensore di movimento con sensore di prossimità
	Battery, rechargeable battery, battery and rechargeable battery operation possible	Es posible su uso con pilas, con batería o con pila y batería	Sono possibili i funzionamenti a batteria, accumulatore e batteria + accumulatore
	Battery/rechargeable battery included	Pila / batería incluida	Batteria/accumulatore in dotazione
	Battery/rechargeable battery replaceable	Batería/acumulador intercambiable	Batteria/pila sostituibile
	Wall, floor and/or ceiling fitting	Montaje a pared, suelo y/o techo	Montaggio a parete, pavimento e/o soffitto
	Maximum load	Carga máx.	Carico max.
	Wire/rod distance	Distancia de cable/barra	Distanza fune/asta
	Base	Casquill	Zoccolo
K	Kelvin, colour temperature See page 441 for further details	kelvin, temperatura de color Para más información, véase pág. 441	Kelvin, temperatura di colore Per le spiegazioni vedi pagina 441
S	Dummy output	Potencia aparente	Potenza apparente
	Easily fitted	Montaje simple	Facile montaggio
	Only for indoor use	uso sólo en interiores	Solo per interni
	Toroid transformer	Transformador toroidal	Trasformatore a nucleo toroidale
	Integrated spark protection	Protección contra interferencias integrada	Protezione radio integrata
	Integrated soft start	Softstart integrado	Avvio "soft" integrado
	Integrated short circuit protection	Protección contra cortocircuitos integrada	Protezione da corto circuito integrada
	Increased spike protection	Mayor protección contra perturbaciones	Maggiore protezione "anti-spike"
	Integrated fire protection	Protección contra incendios integrada	Protezione antincendio integrada
	Integrated overload protection	Protección contra sobrecarga integrada	Protezione da sovraccarico integrada
	Integrated re-startable temperature monitor	Sensor de temperatura reconectable integrado	riattivabile integrato
	Integrated temperature monitor and electronic fuse	Sensor de temperatura integrado y fusible electrónico	Termostato integrado e fusibile elettronico
	Integrated electronic fuse	Fusible electrónico integrado	Fusibile elettronico integrado



	Integrated fine-wire fuse	Fusible para baja intensidad integrado	Fusibile per correnti deboli integrato
	Self-service pack	Embalaje SB	Imballaggio "SB"
	Packaging unit	Unidad de embalaje	Unità d'imballaggio
	Energy-efficiency class	clase de ahorro energético	Classe di efficienza energetica
	Flicker-free quick start	encendido inmediato sin centelleo	Accensione immediata senza luce pulsante
	Service life	vida útil	Durata utile
	Service life, electronic ballast	vida útil reactancia electrónica	Durata utile alimentatore elettronico
	Not for general lighting, only for decorative purposes or special applications	No apto para iluminación general, solo para fines decorativos o aplicaciones especiales	Non per l'illuminazione generale, solo a fini decorativi o per applicazioni speciali
	Fabric cable	Cable textil	Cavo tessile
	Dimmable with Smart Home app	Regulable con la aplicación Smart Home	Dimmerabile con l'App Smart Home
	Bluetooth	Bluetooth	Bluetooth
	Zigbee	Zigbee	Zigbee
	With USB plug	Con conector USB	Con connettore USB
	With USB connection	Con conexión USB	Con collegamento USB
	Safety plug	Toma de tierra	Presa di terra
	variably adjustable	regulable	regolazione variabile
	can be shortened once	acortable una única vez	accorciabile una volta
	Can be dimmed using leading edge dimmer. See page 443 for further details	Regulable con un reductor de corte de inicio de fase. Para más explicación véase la página 443	Variazione dell'intensità luminosa con dimmer di fase nella sezione di accensione. Per le spiegazioni vedi pagina 443
	Can be dimmed using trailing edge dimmer. See page 443 for further details	Regulable con un reductor de corte de fin de fase. Para más explicación véase la página 443	Variazione dell'intensità luminosa con dimmer di fase nella sezione di spegnimento. Per le spiegazioni vedi pagina 443
	dimming See page 440 for further details	regulable Para más explicación véase la página 440	regolabile Per le spiegazioni vedi pagina 440
	3 step dim See page 440 for further details	3 step dim Para más explicación véase la página 440	3 step dim Per le spiegazioni vedi pagina 440
	Easy dim See page 440 for further details	Easy dim Para más explicación véase la página 440	Easy dim Per le spiegazioni vedi pagina 440
	3 Step dim to warm See page 440 for further details	3 Step dim to warm Para más explicación véase la página 440	3 Step dim to warm Per le spiegazioni vedi pagina 440
	Dim to warm See page 440 for further details	Dim to warm Para más explicación véase la página 440	Dim to warm Per le spiegazioni vedi pagina 440
	White Switch See page 441 for further details	White Switch Para más explicación véase la página 441	White Switch Per le spiegazioni vedi pagina 441
	Tunable white See page 441 for further details	Blanco ajustable Para más explicación véase la página 441	Bianco regolabile Per le spiegazioni vedi pagina 441
	RGBW See page 441 for further details	RGBW Para más explicación véase la página 441	RGBW Per le spiegazioni vedi pagina 441
	RGB Rainbow See page 441 for further details	RGB Rainbow Para más explicación véase la página 441	RGB Rainbow Per le spiegazioni vedi pagina 441

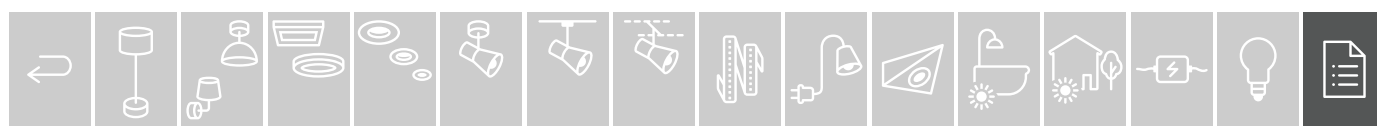





**Paulmann**

[www.paulmann.com](http://www.paulmann.com)

Paulmann Licht GmbH | Quezinger Feld 2 | 31832 Springe/Germany