

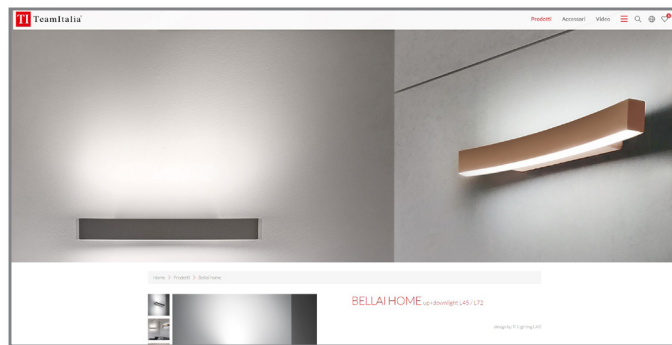

CATALISTINO
WORKING CATALOGUE
2023

INTERACTIVE WORKING CATALOGUE



www.teamitaliailluminazione.it



BELLA HOME

PARETE WALL LIGHT WANDLEUCHTE

configurazione standard: / basic configuration: / Standard Konfiguration:

E28 Sottile Flat - Slim **B** 3000K

	2027AOFBVE28B 15W 1600lm + 15W 1600lm - 220V	296,00 €
	2027ADM BVE28B DALI (Push) - 15W 1600lm + 15W 1600lm - 220V	369,00 €
	2027ATFBVE28B 15W 1600lm + 15W 1600lm - 220V	369,00 €
	2027BOFBVE28B 20W 2125lm + 20W 2125lm - 220V	603,00 €
	2027BDM BVE28B DALI (Push) - 20W 2125lm + 20W 2125lm - 220V	701,00 €

Configura Configura / Konfigurieren www.teamitaliailluminazione.it

A 2700K **B** 3000K

TF Taglio di Fase - Phase Cut Dimmer - Phasenabschrittdimmer
A Alimentatore Incorporato - Incorporated Power Supply - Eingebautes Netzeil
 * 1600lm effettivi - effective - effektive con - with - mit **E28**

INDEX
SECTION
FAMILY 13

- Sistemi modulari (Modular Systems/Modulare Systeme) 412
 - Sospensione, quadrilatera, rettangolare 412
 - Sospensione, cilindrica, sferica, pendente 413
 - Parete/Wall Light/Wandleuchte 414
 - Plafone/Deckenleuchte 415
 - Piantana/Ceiling Light/Deckenleuchte 416
 - Incasso/Recessed Light/Einbauleuchte 417
 - Binario/Track System 418
- Binario 48V/Track 48V/Track 48V/Gleis 48V 418
 - Binario 48V/Track 48V/Track 48V/Gleis 48V 418
- Gestione della luce/Light Management 444
 - Light Management per colore 444
 - Light Management per temperatura 445
 - Light Management per intensità 446
 - Light Management per modalità 447
- Accessori/Accessories/Zubehör 454
 - Complementi elettrici/Electrical Accessories/Elektrische Zubehör 454
 - Complementi meccanici/Mechanical Accessories/Mechanische Zubehör 455
 - Complementi ottici/Optical Accessories/Optische Zubehör 456
 - Complementi di servizio/Service Accessories/Service Zubehör 457
 - Complementi di servizio e gestione dell'ambiente 458
- Complementi meccanici/Mechanical Accessories/Mechanische Zubehör 455
 - Complementi ottici/Optical Accessories/Optische Zubehör 456
 - Complementi di servizio/Service Accessories/Service Zubehör 457
 - Complementi di servizio e gestione dell'ambiente 458
- LUBRIFICAZIONE 459
- INFORMAZIONI 460
- INDIZIONE 461

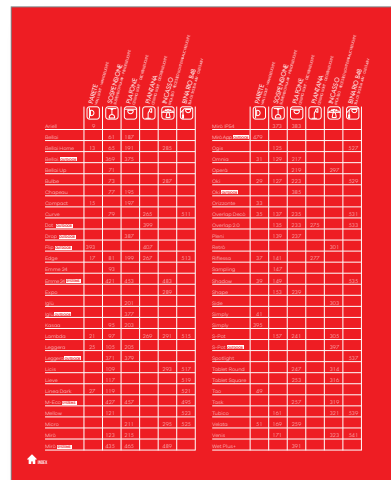





	PARETE WALL LIGHT - WANDLEUCHTE	SOSPENSIONE SUSPENSION LAMP - PENDELEUCHTE	PLAFONE CEILING LIGHT - DECKENLEUCHTE	PIANTANA CEILING LIGHT - DECKENLEUCHTE	INCASSO RECESSED LIGHT EINBAULEUCHTE	BINARIO B48 TRACK SYSTEM 48V - GLEIS 48V
Ariell	9					
Bellai		61	187			
Bellai Home	13	65	191		285	
Bellai OUTDOOR		369	375			
Bellai Up		71				
Bulbe		73			287	
Chapeau		77	195			
Compact	15		197			
Curve		79		265		511
Dot OUTDOOR				399		
Drop OUTDOOR			387			
Flip OUTDOOR	393			407		
Edge	17	81	199	267		513
Emme 24		93				
Emme 24 SYSTEMS		421	453		483	
Expo					289	
Iglù			201			
Iglù OUTDOOR			377			
Kasaa		95	203			
Lambda	21	97		269	291	515
Leggera	25	105	205			
Leggera OUTDOOR		371	379			
Licis		109			293	517
Lieve		117				519
Linea Dark	27	119				521
M-Eco SYSTEMS		427	457			495
Mellow		121				523
Micro			211		295	525
Mirò	123	215				
Mirò SYSTEMS	435	465			489	
Mirò IP54 OUTDOOR		373	383			
Mirò App. SYSTEM	479					
Ogis		125				527
Omnia	31	129	217			
Operà			219		297	
Okì	29	127	223			529
Okì OUTDOOR				385		
Orizzonte	33					
Overlap Decò	35	137	235			531
Overlap 2.0		135	233	275		533
Pleni		139	237			
Retrò						301
Riflessa	37	141		277		
Sampling		147				
Shadow	39	149				535
Shape		153	239			
Side						303
Simply	41					
Simply OUTDOOR	395					
S-Pot		157	241			305
S-Pot OUTDOOR						397
Spotlight						537
Tablet Round			247			314
Tablet Square			253			316
Tao	49					
Task			257			319
Tubico		161				321 539
Velata	51	169	259			
Venis		171				323 541
Wet Plus+ OUTDOOR			391			

INDICE SEZIONI

SECTION INDEX









Home+Architectural

 PARETE - WALL LIGHT - WANDLEUCHTE	6
 SOSPENSIONE - SUSPENSION LAMP - PENDELLEUCHTE	54
 PLAFONE - CEILING LIGHT - DESCKENLEUCHTE	180
 PIANTANA - FLOOR LAMP - STEHLAMP	262







Incasso - Recessed light - Einbauleuchte

 INCASSO - RECESSED LIGHT - EINBAULEUCHTE	285
--	-----





Profili/Profiles/Profile

 UNIVERSALI/UNIVERSAL/UNIVERSAL	329
 VELETTE LUMINOSE/WALL WASHING EFFECT/WALL WASHER-EFFEKT	341
 INCASSO CON CORNICE/RECESSED PROFILE/EINBAU PROFILE	347
 INCASSO A RASO/RECESSED WALL FLUSH EFFECT/EINBAUCHTE BÜNDIG MIT DER WAND	355
 STRIPLED IP20 / IP65	360
 ROLLE LED IP20 / IP65	361
 DRIVERS & DIMMER	362
 SCATOLE MINIMAL	363

Outdoor

 SOSPENSIONE/HANGING LAMP/PENDELLEUCHTE	369
 PLAFONE/CEILING/DECKENLEUCHTE	375
 DROP - ACCESSORI/ACCESSORIES/ZUBEHÖR	388
 PARETE/WALL LIGHT/WANDELEUCHTE	393
 INCASSO/RECESSED/EINBAUCHTE	397
 FISSAGGIO A TERRA/GROUND FIXING/BODENBEFESTIGUNG	399





Sistemi modulari/Modular Systems/Modulare Systeme

 SOSPENSIONE - SUSPENSION LAMP - PENDELLEUCHTE	418
 PLAFONE - CEILING LIGHT - DESCKENLEUCHTE	453
 PARETE/WALL LIGHT/WANDELEUCHTE	479
 INCASSO/RECESSED/EINBAUCHTE	483
 BINARIO/TRACK/ELEKTRIFIZIATE STROMSCHIENE	495

Binario 48V/Track 48V/Track 48V/Gleis 48V

 BINARIO 48V/TRACK 48V/TRACK 48V/STROMSCHIENE 48V	504
--	-----

Gestione della luce/Light Management

 BLC - Bluetooth Light Control	546
 PLC - Push Light Control	547
 RLC - Remote Light Control	548
 WLC - Wall Light Control	551

Accessori/Accessories/Zubehör

COMPONENTI ELETTRICI/ELECTRICAL ACCESSORIES/ELEKTRISCHES ZUBEHÖR

 STRIPLED IP20 / IP65	562
 ROLLE LED IP20 / IP65	563
 DRIVERS CC	564
 DRIVERS CV 24/48V	565
 GUIDECAVO/CABLE GUIDE/KABELFÜHRUNG	567

COMPONENTI MECCANICI/MECHANICAL ACCESSORIES/MECHANISCHE ZUBEHÖR

 ROSONI / CANOPY	569
---	-----

LEGENDA	570
---------	-----

CONDIZIONI GENERALI DI VENDITA	574
--------------------------------	-----

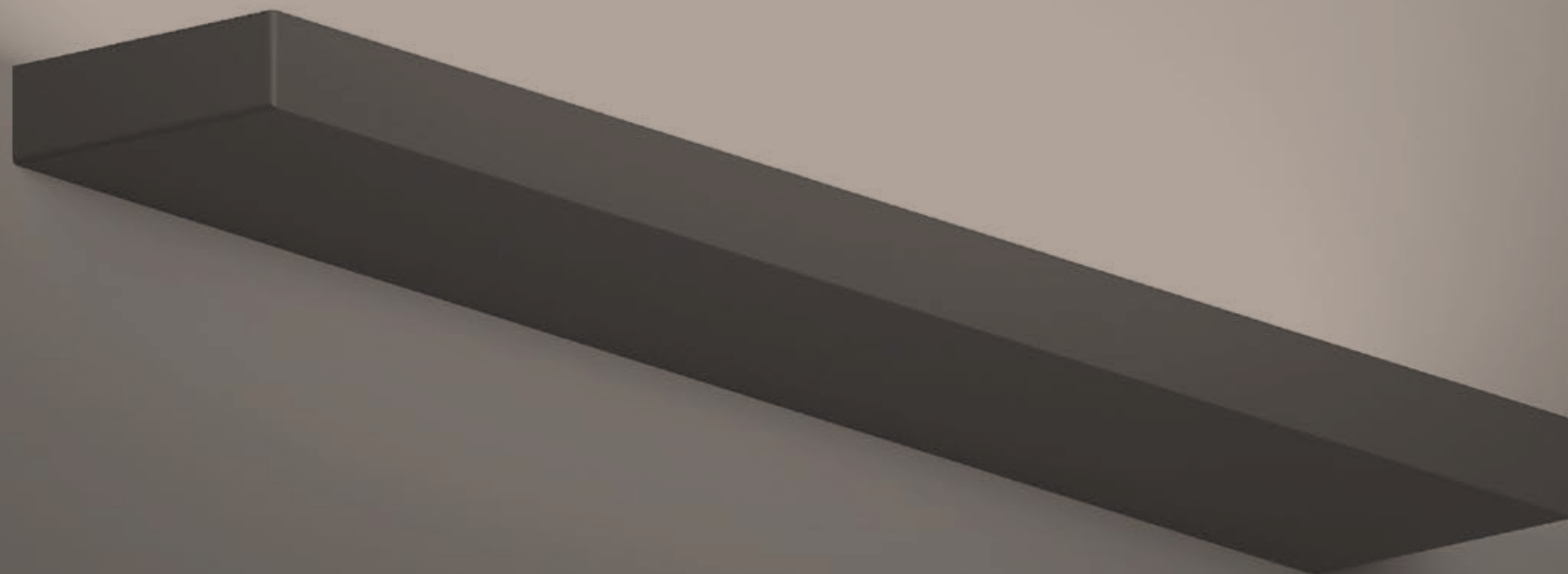

PARETE
WALL LIGHT
WANDLEUCHTE





Ariell
uplight L17/L30/L60

9



Ariell
uplight superflux L35/L120

9



Ariell
up+down superflux L35/L90

11



Bellai Home
up+downlight L45/L72

13



Compact
omnilight L8

15



Compact
omnilight L20/L35/L60

15



Edge
downlight L133/L175

17



Edge
downlight L22

19



Lambda
downlight Ø20 H45

21



Lambda
downlight Ø20 H130

23



Leggera
omnilight Ø45/Ø65/Ø82

25



Linea Dark
downlight L32/L60/L88/L116

27

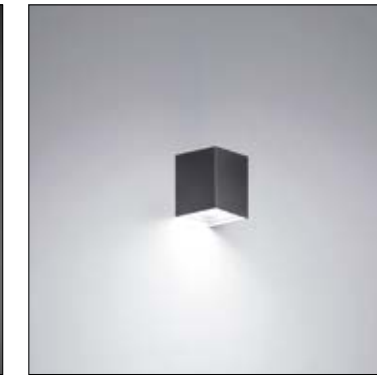

Oki
downlight L7,4x7,4 H8,5

29

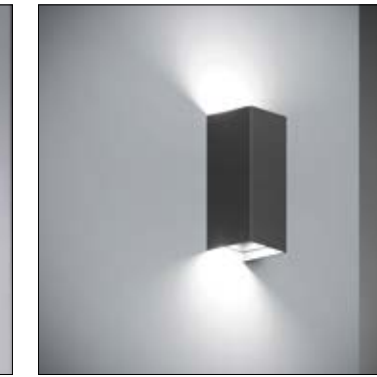

Oki
up+downlight L7,5x7,5 H18

29



Omnia
diffusa L28/L56

31

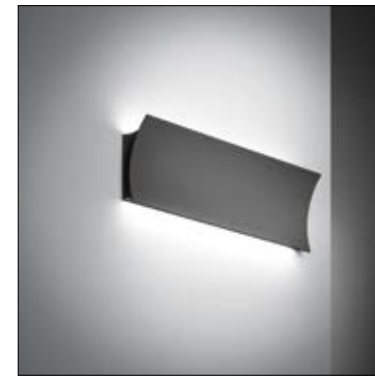

Orizzonte
up+downlight L12,5/L25/L63,5/L93

33

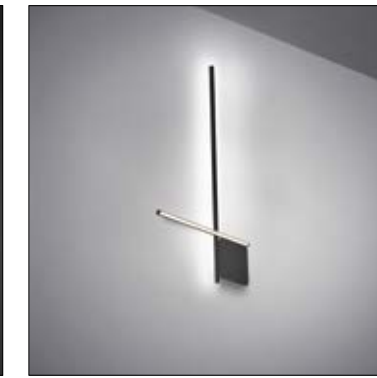

Overlap
back+front light H90xL45

35



Riflessa
uplight L20/45

37

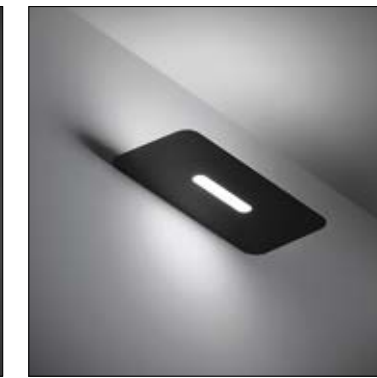

Riflessa
uplight + downlight L45

37

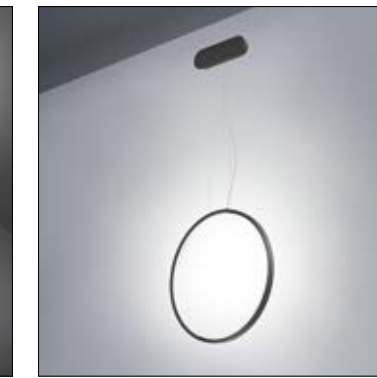

Shadow
verticale Ø58/Ø70/Ø95

39



Simply
up+downlight L17/L30/L60/L114/L170

41-43



Simply Up
uplight L17/L30/L60/L114

45-47



Tao
up+downlight L25/L50/L75

49



Velata
Wall Light Ø35/ Ø45

51



configurazione standard: / basic configuration: / Standard Konfiguration:

E28 Satinato
Frosted - Satiniert

● B 3000K

BV

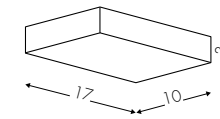

2026BOFBVE28B 9W 1350lm* - 220V **151,00 €**
2026BTFBVE28B 9W 1350lm - 220V **179,00 €**

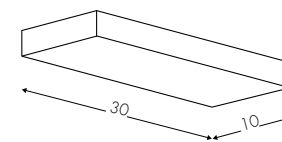

2026DOFBVE28B 21W 3000lm - 220V **221,00 €**
2026DDMBVE28B DALI (Push) - 21W 3000lm - 220V **276,00 €**
2026DTFBVE28B 21W 3000lm - 220V **276,00 €**

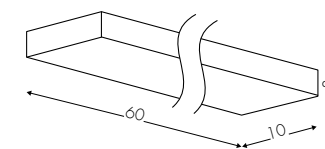

2026FOFBVE28B 35W 5000lm - 220V **368,00 €**
2026FDMBVE28B DALI (Push) - 35W 5000lm - 220V **420,00 €**

Configura Configure / Konfigurieren

www.teamitaliailluminazione.it

SUPERFLUX

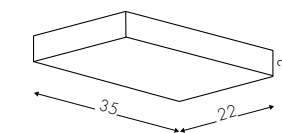

2026MOFBVE28B 60W 8200lm* - 220V **336,00 €**
2026MDMBVE28B DALI (Push) - 60W 8200lm - 220V **380,00 €**

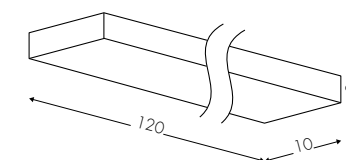

2026NOFBVE28B 70W 9200lm - 220V **585,00 €**
2026NDMBVE28B DALI (Push) - 70W 9200lm - 220V **642,00 €**

Configura Configure / Konfigurieren

www.teamitaliailluminazione.it



● A 2700K

NE RU

CODICE COMPLETO DEL PRODOTTO NELLA FOTO
FULL PRODUCT CODE AS SHOWN IN PICTURE - VOLLSTÄNDIGER CODE VOM ARTIKEL IM BILD

2026FOF **RU** **E28** **A**

Codice
Code

Finitura
Finishing
Lackierung

Diffusore
Diffuser
Diffusor

Tonalità
Hue
Farbton

TF Taglio di Fase - Phase-Cut Dimmer - Phasenabschnittdimmer

A Alimentatore Incorporato - Incorporated Power Supply - Eingebautes Netzteil

* 1350lm effettivi - effective - effektive con - with - mit **E28**



configurazione standard: / basic configuration: / Standard Konfiguration:

E28 Satinato
Frosted - Satinert

● B 3000K

BV

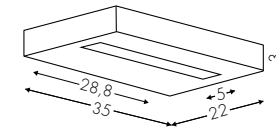

2026OOFBVE28B
2026ODMBVE28B

50W 6500lm* + 10W 1500lm - 220V
DALI (Push) - 50W 6500lm + 10W 1500lm - 220V

402,00 €
446,00 €

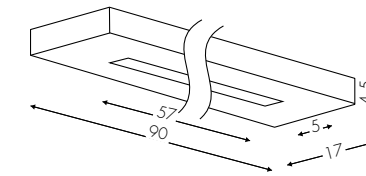

2026QOFBVE28B
2026QDMBVE28B

50W 6500lm + 10W 1500lm - 220V
DALI (Push) - 50W 6500lm + 10W 1500lm - 220V

557,00 €
611,00 €

Configura

Configure / Konfigurieren

www.teamitaliailluminazione.it



● A 2700K

NE RU

A Alimentatore Incorporato - Incorporated Power Supply - Eingebautes Netzteil

* 6500lm effettivi - effective - effektive con - with - mit E28

CODICE COMPLETO DEL PRODOTTO NELLA FOTO
FULL PRODUCT CODE AS SHOWN IN PICTURE - VOLLSTÄNDIGER CODE VOM ARTIKEL IM BILD

2026QOF **NE** **E28** **A**

Codice
Code

Finitura
Finishing
Lackierung

Diffusore
Diffuser
Diffusor

Tonalità
Hue
Farbton



configurazione standard: / basic configuration: / Standard Konfiguration:

E28 Satinato
Frosted - Satinert

● B 3000K

BV

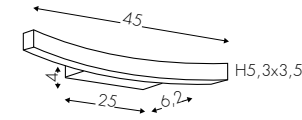

2027AOFBVE28B
2027ADMBVE28B
2027ATFBVE28B

15W 1600lm* + 15W 1600lm - 220V
DALI (Push) - 15W 1600lm + 15W 1600lm - 220V
15W 1600lm + 15W 1600lm - 220V

296,00 €
369,00 €
369,00 €

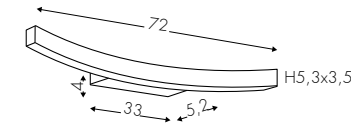

2027BOFBVE28B
2027BDMBVE28B

20W 2125lm + 20W 2125lm - 220V
DALI (Push) - 20W 2125lm + 20W 2125lm - 220V

603,00 €
701,00 €

Configura

Configure / Konfigurieren

www.teamitaliailluminazione.it



● A 2700K

NE RU

CODICE COMPLETO DEL PRODOTTO NELLA FOTO
FULL PRODUCT CODE AS SHOWN IN PICTURE - VOLLSTÄNDIGER CODE VOM ARTIKEL IM BILD

2027BOF **RU** **E28** **A**

Codice
Code

Finitura
Finishing
Lackierung

Diffusore
Diffuser
Diffusor

Tonalità
Hue
Farbton

TF Taglio di Fase - Phase-Cut Dimmer - Phasenabschnittdimmer

A Alimentatore Incorporato - Incorporated Power Supply - Eingebautes Netzteil

* 1600lm effettivi - effective - effektive con - with - mit **E28**

COMPACT

PARETE
WALL LIGHT
WANDLEUCHTE



configurazione standard: / basic configuration: / Standard Konfiguration:

E2 Opale - Opal ● B 3000K

BV

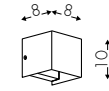

D320BVE2B 4W 350lm* - 220V

157,00 €

Configura Configure / Konfigurieren

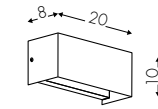

D321BVE2B 7W 1100lm - 220V

195,00 €

D321TFBVE2B 7W 1100lm - 220V

224,00 €

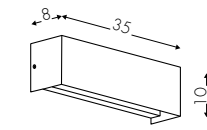

D326BVE2B 21W 2420lm - 220V

280,00 €

D326DMBVE2B DALI (Push) - 21W 2420lm - 220V

344,00 €

D326TFBVE2B 21W 2420lm - 220V

344,00 €

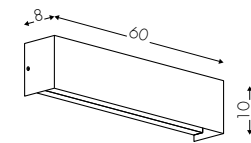

D325BVE2B 29W 3400lm - 220V

374,00 €

D325DMBVE2B DALI (Push) - 29W 3400lm - 220V

439,00 €

Configura Configure / Konfigurieren

www.teamitaliailluminazione.it



● A 2700K

BV

CODICE COMPLETO DEL PRODOTTO NELLA FOTO
FULL PRODUCT CODE AS SHOWN IN PICTURE - VOLLSTÄNDIGER CODE VOM ARTIKEL IM BILD

D321

Codice
Code

BV

Finitura
Finishing
Lackierung

E2

Diffusore
Diffuser
Diffusor

A

Tonalità
Hue
Farbton

TF Taglio di Fase - Phase-Cut Dimmer - Phasenabschrittdimmer

A Alimentatore Incorporato - Incorporated Power Supply - Eingebautes Netzteil

* 350lm effettivi - effective - effektive con - with - mit **E2**



configurazione standard: / basic configuration: / Standard Konfiguration:

E2 Opale - Opal

● B 3000K

BV

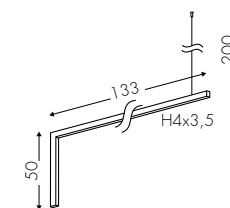

2028GOFBVE2B
2028GDMBVE2B

34W 2490lm* - 220V
DALI (Push) - 34W 2490lm - 220V

489,00 €
528,00 €

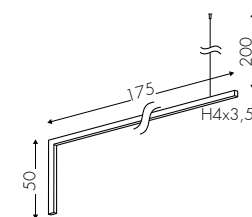

2028EOFBVE2B
2028EDMBVE2B

51W 3740lm - 220V
DALI (Push) - 51W 3740lm - 220V

513,00 €
577,00 €

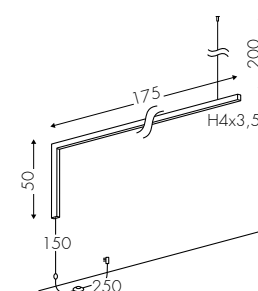

2028FOFBVE2B
2028FDMBVE2B

51W 3740lm - 220V
DALI (Push) - 51W 3740lm - 220V

577,00 €
651,00 €

Configura

Configure / Konfigurieren

www.teamitaliailluminazione.it



E19 Prismatico - Prism

● A 2700K

NE RU



A Alimentatore Incorporato - Incorporated Power Supply - Eingebautes Netzteil

* 2490lm effettivi - effective - effektive con - with - mit **E2**
2930lm effettivi - effective - effektive con - with - mit **E19** ↻ +17,5%

CODICE COMPLETO DEL PRODOTTO NELLA FOTO
FULL PRODUCT CODE AS SHOWN IN PICTURE - VOLLSTÄNDIGER CODE VOM ARTIKEL IM BILD

2028GOF **NE** **E2** **B**

Codice
Code

Finitura
Finishing
Lackierung

Diffusore
Diffuser
Diffusor

Tonalità
Hue
Farbton



configurazione standard: / basic configuration: / Standard Konfiguration:

E2 Opale - Opal

● B 3000K

BV

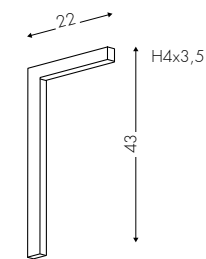

2028AOFBVE2B

9W 977lm* - 220V

352,00 €

Configura Configure / Konfigurieren

www.teamitaliailluminazione.it



E19 Prismatizzato - Prism

● A 2700K

NE RU

A Alimentatore Incorporato - Incorporated Power Supply - Eingebautes Netzteil

* 977lm effettivi - effective - effektive con - with - mit E2
1150lm effettivi - effective - effektive con - with - mit E19 ↻ +17,5%

CODICE COMPLETO DEL PRODOTTO NELLA FOTO
FULL PRODUCT CODE AS SHOWN IN PICTURE - VOLLSTÄNDIGER CODE VOM ARTIKEL IM BILD

2028AOF **NE** **E2** **A**

Codice
Code

Finitura
Finishing
Lackierung

Diffusore
Diffuser
Diffusor

Tonalità
Hue
Farbton



configurazione standard: / basic configuration: / Standard Konfiguration:

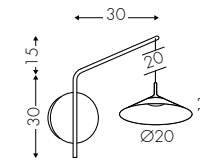

E19 Prismatico - Prism

B 3000K



2071ATFONE19B

6,5W 800lm* - 220V

345,00 €

C005A2TR

Custom transparent cable

7,00 € /MT

Configura



Configure / Konfigurieren

www.teamitaliailluminazione.it



A 2700K



CODICE COMPLETO DEL PRODOTTO NELLA FOTO
FULL PRODUCT CODE AS SHOWN IN PICTURE - VOLLSTÄNDIGER CODE VOM ARTIKEL IM BILD

2071ATF **ON** **E19** **B**

Codice
Code

Finitura
Finishing
Lackierung

Diffusore
Diffuser
Diffusor

Tonalità
Hue
Farbton

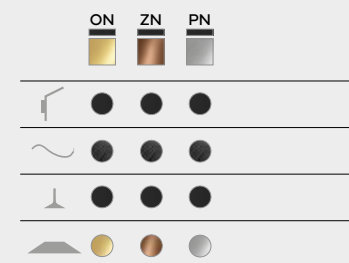

A Alimentatore Incorporato - Incorporated Power Supply - Eingebautes Netzteil

TF Taglio di Fase - Phase-Cut Dimmer - Phasenabschrittdimmer

* 800lm effettivi - effective - effektiven con - with - mit **E19**



configurazione standard: / basic configuration: / Standard Konfiguration:

E19 Prismatico - Prism ● B 3000K



5071ADPONE19B 6,5W 800lm* - 220V

540,00 €

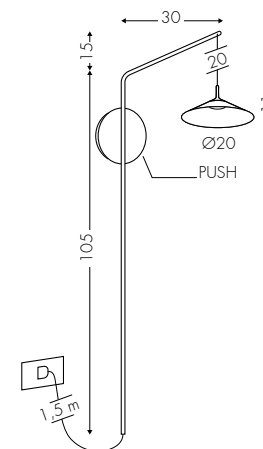

C005A2TR Custom transparent cable

7,00 € /MT

Configura Configure / Konfigurieren

www.teamitaliailluminazione.it



● A 2700K



CODICE COMPLETO DEL PRODOTTO NELLA FOTO
FULL PRODUCT CODE AS SHOWN IN PICTURE - VOLLSTÄNDIGER CODE VOM ARTIKEL IM BILD

5071ADP PN E19 A

Codice Code	Finitura Finishing Lackierung	Diffusore Diffuser Diffusor	Tonalità Hue Farbton
----------------	-------------------------------------	-----------------------------------	----------------------------

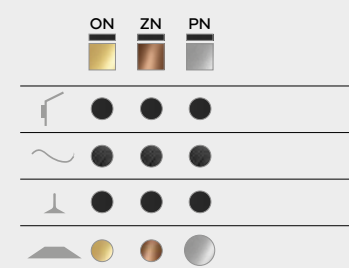

A Alimentatore Incorporato - Incorporated Power Supply - Eingebautes Netzteil
DP Dimmerabile con pulsante - Dimmable with pushbutton - Dimmbare mit Touch-Button

* 800lm effettivi - effective - effektiven con - with - mit **E19**

LEGGERA

PARETE
WALL LIGHT
WANDLEUCHTE



configurazione standard: / basic configuration: / Standard Konfiguration:

E2 Opale - Opal

● B 3000K

BV

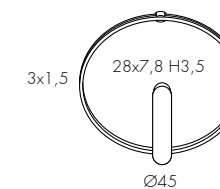

2032COFBVE2B
2032CDMBVE2B
2032CTFBVE2B

25W 1260lm* - 220V
DALI (Push) - 25W 1260lm - 220V
25W 1260lm - 220V

474,00 €
553,00 €
553,00 €

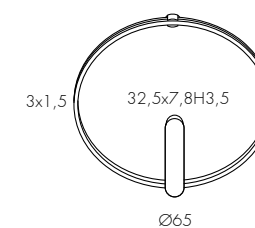

2032AOFBVE2B
2032ADMBVE2B
2032ATFBVE2B

35W 1740lm - 220V
DALI (Push) - 35W 1740lm - 220V
35W 1740lm - 220V

601,00 €
697,00 €
697,00 €

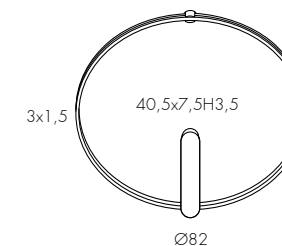

2032BOFBVE2B
2032BDMBVE2B
2032BTFBVE2B

48W 2580lm - 220V
DALI (Push) - 48W 2580lm - 220V
48W 2580lm - 220V

709,00 €
808,00 €
808,00 €

Configura

Configure / Konfigurieren

www.teamitaliailluminazione.it



● A 2700K

NE RV BR OV

TF Taglio di Fase - Phase-Cut Dimmer - Phasenabschnittdimmer

A Alimentatore Incorporato - Incorporated Power Supply - Eingebautes Netzteil

* 1260lm effettivi - effective - effektive con - with - mit **E2**

CODICE COMPLETO DEL PRODOTTO NELLA FOTO
FULL PRODUCT CODE AS SHOWN IN PICTURE - VOLLSTÄNDIGER CODE VOM ARTIKEL IM BILD

2032BOF | **OV** | **E2** | **A**

Codice
Code

Finitura
Finishing
Lackierung

Diffusore
Diffuser
Diffusor

Tonalità
Hue
Farbton

INDEX

SECTION

FAMILY 25

LINEA DARK

PARETE
WALL LIGHT
WANDLEUCHTE



configurazione standard: / basic configuration: / Standard Konfiguration:

E2 Opale - Opal

B 3000K

BV

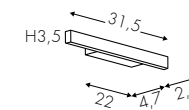

2021AOFBVE2B

10W 1250lm* - 220V

190,00 €

2021ATFBVE2B

10W 1250lm - 220V

219,00 €

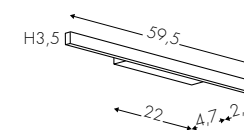

2021BOFBVE2B

20W 2200lm - 220V

246,00 €

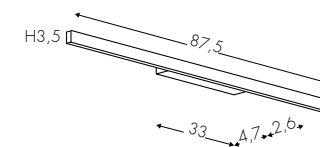

2021COFBVE2B

30W 3400lm - 220V

347,00 €

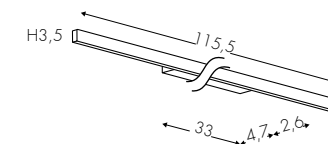

2021DOFBVE2B

38W 4400lm - 220V

427,00 €

Configura

Configure / Konfigurieren

www.teamitaliailluminazione.it



A 2700K

NE RU

CODICE COMPLETO DEL PRODOTTO NELLA FOTO
FULL PRODUCT CODE AS SHOWN IN PICTURE - VOLLSTÄNDIGER CODE VOM ARTIKEL IM BILD

2021BOF **NE** **E2** **A**

Codice
Code

Finitura
Finishing
Lackierung

Diffusore
Diffuser
Diffusor

Tonalità
Hue
Farbton

TF Taglio di Fase - Phase-Cut Dimmer - Phasenabschnittdimmer

A Alimentatore Incorporato - Incorporated Power Supply - Eingebautes Netzteil

* 1250lm effettivi - effective - effektive con - with - mit **E2**

INDEX

SECTION

FAMILY 27



configurazione standard: / basic configuration: / Standard Konfiguration:

GU10

BV

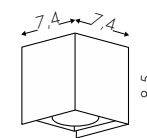

2009AOFBV

1x GU10 max 7W - 220V

89,00 €

Configura

Configure / Konfigurieren

www.teamitaliailluminazione.it

2009BOFBV

2x GU10 max 7W - 220V

165,00 €

Configura

Configure / Konfigurieren

www.teamitaliailluminazione.it

NE RU

GU10 Sorgente GU10 non inclusa - GU10 light source not included - GU10 Lichtquelle nicht enthalten

CODICE COMPLETO DEL PRODOTTO NELLA FOTO
FULL PRODUCT CODE AS SHOWN IN PICTURE - VOLLSTÄNDIGER CODE VOM ARTIKEL IM BILD

2009BOF **NE**

Codice
Code

Finitura
Finishing
Lackierung





configurazione standard: / basic configuration: / Standard Konfiguration:

E2 Opale - Opal

 B 3000K

BV

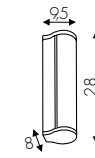

2060ATFBVE2B

7W 714lm* - 220V

188,00 €



2060BTFBVE2B
2060BDMBVE2B

13W 1428lm - 220V

228,00 €

DALI (Push) 13W 1428lm - 220V

272,00 €

Configura 

Configure / Konfigurieren

www.teamitaliailluminazione.it 



 A 2700K  C 4000K

NE

 **CODICE COMPLETO DEL PRODOTTO NELLA FOTO**
FULL PRODUCT CODE AS SHOWN IN PICTURE - VOLLSTÄNDIGER CODE VOM ARTIKEL IM BILD

2060BTF | **NE** | **E2** | **C**

Codice
Code

Finitura
Finishing
Lackierung

Diffusore
Diffuser
Diffusor

Tonalità
Hue
Farbton

TF Taglio di Fase - Phase-Cut Dimmer - Phasenabschnittdimmer

A Alimentatore Incorporato - Incorporated Power Supply - Eingebautes Netzteil

* 714lm effettivi - effective - effektive con - with - mit **E2**



configurazione standard: / basic configuration: / Standard Konfiguration:

E28 Satinato
Frosted - Satiniert

B 3000K

BV

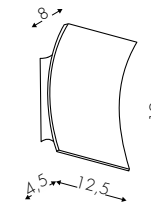

2004EOFBVE28B 4,5W 450lm* + 4,5W 450lm - 220V **152,00 €**
2004ETFBVE28B 4,5W 450lm + 4,5W 450lm - 220V **198,00 €**

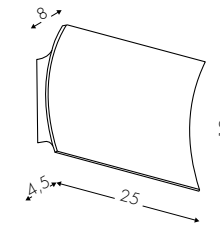

2004DOFBVE28B 10W 1300lm + 10W 1300lm - 220V **269,00 €**
2004DDMBVE28B DALI (Push) - 10W 1300lm + 10W 1300lm - 220V **313,00 €**
2004DTFBVE28B 10W 1300lm + 10W 1300lm - 220V **313,00 €**

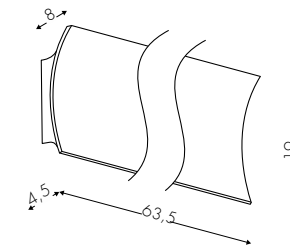

2004COFBVE28B 18W 1800lm + 18W 1800lm - 220V **477,00 €**
2004CDMBVE28B DALI (Push) - 18W 1800lm + 18W 1800lm - 220V **593,00 €**
2004CTFBVE28B 18W 1800lm + 18W 1800lm - 220V **593,00 €**

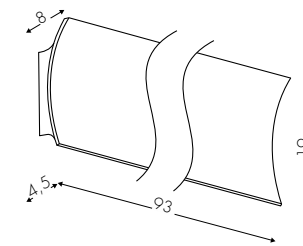

2004AOFBVE28B 26W 2700lm + 26W 2700lm - 220V **551,00 €**
2004ADMBVE28B DALI (Push) - 26W 2700lm + 26W 2700lm - 220V **668,00 €**
2004AOFEMBVE28B 26W 2700lm + 26W 2700lm - 220V **735,00 €**

Configura

Configure / Konfigurieren

www.teamitaliailluminazione.it



A 2700K

RU

CODICE COMPLETO DEL PRODOTTO NELLA FOTO
FULL PRODUCT CODE AS SHOWN IN PICTURE - VOLLSTÄNDIGER CODE VOM ARTIKEL IM BILD

2004DOF **RU** **E28** **B**

Codice
Code

Finitura
Finishing
Lackierung

Diffusore
Diffuser
Diffusor

Tonalità
Hue
Farbton

EM Emergenza - Emergency - Notbeleuchtung

TF Taglio di Fase - Phase-Cut Dimmer - Phasenabschrittdimmer

A Alimentatore Incorporato - Incorporated Power Supply - Eingebautes Netzteil

* 450lm effettivi - effective - effektive con - with - mit **E28**

OVERLAP DECÓ

PARETE
WALL LIGHT
WANDLEUCHTE



configurazione standard: / basic configuration: / Standard Konfiguration:

E2 Opale - Opal

B 3000K

BV



2015ATFBVE2B

26W 2295lm* + 13W 1150lm - 220V

460,00 €

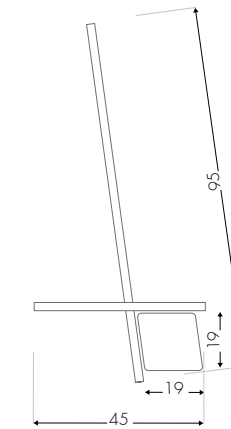
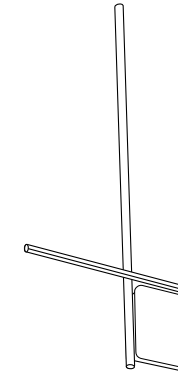

Configura

Configure / Konfigurieren

www.teamitaliailluminazione.it



A 2700K



CODICE COMPLETO DEL PRODOTTO NELLA FOTO
FULL PRODUCT CODE AS SHOWN IN PICTURE - VOLLSTÄNDIGER CODE VOM ARTIKEL IM BILD

2015ATF **OV** **E2** **B**

Codice
Code

Finitura
Finishing
Lackierung

Diffusore
Diffuser
Diffusor

Tonalità
Hue
Farbton

INDEX

SECTION

FAMILY 35





configurazione standard: / basic configuration: / Standard Konfiguration:

E2 Opale - Opal - Opal ● B 3000K

BV



2052AOFBVE2B
2052ATFBVE2B

15W 1900lm* - 220V
15W 1900lm - 220V

253,00 €
266,00 €

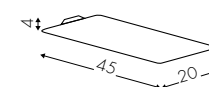

2052COFBVE2B
2052CDBVE2B

23W 2800lm - 220V
DALI (Push) - 23W 2800lm - 220V

308,00 €
329,00 €



Configura Configure / Konfigurieren

www.teamitaliailluminazione.it

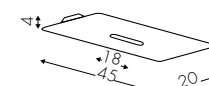

2052DOFBVE2B
2052DDMBVE2B

23W 2800lm + 9W 800lm - 220V
DALI (Push) - 23W 2800lm + 9W 800lm - 220V

371,00 €
420,00 €



Configura Configure / Konfigurieren

www.teamitaliailluminazione.it

● A 2700K

NE RV BR OV

CODICE COMPLETO DEL PRODOTTO NELLA FOTO
FULL PRODUCT CODE AS SHOWN IN PICTURE - VOLLSTÄNDIGER CODE VOM ARTIKEL IM BILD

2052AOF **RV** **E2** **A**

Codice Code	Finitura Finishing Lackierung	Diffusore Diffuser Diffusor	Tonalità Hue Farbton
----------------	-------------------------------------	-----------------------------------	----------------------------

TF Taglio di Fase - Phase-Cut Dimmer - Phasenabschnittdimmer
A Alimentatore Incorporato - Incorporated Power Supply - Eingebautes Netzteil

* 1900lm effettivi - effective - effektive con - with - mit **E2**

SHADOW

PARETE
WALL LIGHT
WANDLEUCHTE



configurazione standard: / basic configuration: / Standard Konfiguration:

E2 Opale - Opal - Opal ● B 3000K

BV

2068ATFBVE2B 39W 2680lm* - 220V 520,00 €
2068ADMBVE2B DALI (Push) - 39W 2680lm - 220V 595,00 €

2068BTFBVE2B 49W 3440lm - 220V 695,00 €
2068BDMBVE2B DALI (Push) - 49W 3440lm - 220V 788,00 €

2068CTFBVE2B 66W 5630lm - 220V 835,00 €
2068CDMBVE2B DALI (Push) - 66W 5630lm - 220V 935,00 €

VA004A Variazione: sostituzione con rosone decentrato
 Variation: substitution with decentralized ceiling rose
 Variante: ersatz durch dezentral deckenrose 88,00 €

CO05T2NE Custom black cable 8,00 € /MT

Configura Configure / Konfigurieren

www.teamitaliailluminazione.it

● ● A

● A 2700K

NE RV BR OV

BV NE RV BR OV

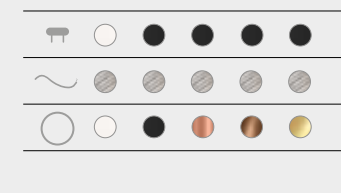

A Alimentatore nel rosone - Power Supply inside the ceiling rose - Netzteil in der Deckendose
TF Taglio di Fase - Phase-Cut Dimmer - Phasenabschrittdimmer

* 2680lm effettivi - effective - effektiven con - with - mit **E2**

INDEX

SECTION

FAMILY 39



CODICE COMPLETO DEL PRODOTTO NELLA FOTO
 FULL PRODUCT CODE AS SHOWN IN PICTURE - VOLLSTÄNDIGER CODE VOM ARTIKEL IM BILD

2068BTF **OV** **E2** **A**

Codice Code
 Finitura Finishing
 Lackierung
 Diffusore Diffuser
 Diffusor
 Tonalità Hue
 Farbton

configurazione standard: / basic configuration: / Standard Konfiguration:

E19 UGR<19 - Prism ● B 3000K

BV

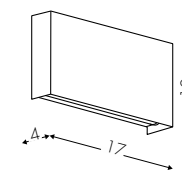

2019EOFBVE19B	14W 2100lm* - 220V	181,00 €
2019EDMBVE19B	DALI (Push) - 14W 2100lm - 220V	229,00 €
2019ETFBVE19B	14W 2100lm - 220V	211,00 €

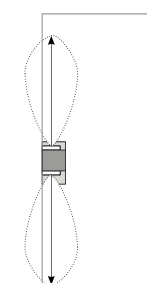

DISTRIBUZIONE
LUMINOSA
LIGHTING EMISSION
LICHT EMISSION

Configura  Configura / Konfigurieren

www.teamitaliailluminazione.it 



● A 2700K ○ C 4000K

NE RU 

TF Taglio di Fase - Phase-Cut Dimmer - Phasenabschnittdimmer
A Alimentatore Incorporato - Incorporated Power Supply - Eingebautes Netzteil

* 2100lm effettivi - effective - effektive con - with - mit **E19**



OV custom finish

 **CODICE COMPLETO DEL PRODOTTO NELLA FOTO**
FULL PRODUCT CODE AS SHOWN IN PICTURE - VOLLSTÄNDIGER CODE VOM ARTIKEL IM BILD

2019EOF **OV** **E19** **B**

Codice Code	Finitura Finishing Lackierung	Diffusore Diffuser Diffusor	Tonalità Hue Farbton
----------------	-------------------------------------	-----------------------------------	----------------------------



configurazione standard: / basic configuration: / Standard Konfiguration:

E19 UGR<19 - Prism

● B 3000K

BV

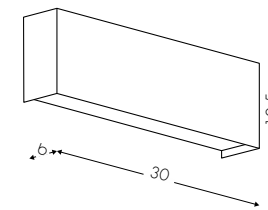

2019AOFBVE19B
2019ADMBVE19B
2019ATFBVE19B

21W 2700lm* - 220V
DALI (Push) - 21W 2700lm - 220V
21W 2700lm - 220V

240,00 €
303,00 €
277,00 €

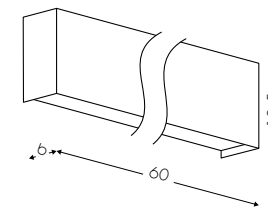

2019BOFBVE19B
2019BDMBVE19B
2019BTFBVE19B

42W 5300lm - 220V
DALI (Push) - 42W 5300lm - 220V
42W 5300lm - 220V

387,00 €
466,00 €
466,00 €

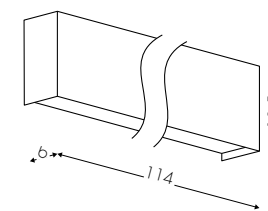

2019COFBVE19B
2019CDMBVE19B

84W 10800lm - 220V
DALI (Push) - 84W 10800lm - 220V

674,00 €
738,00 €

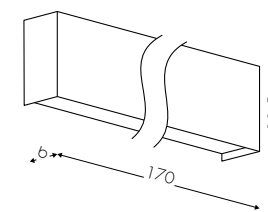

2019DOFBVE19B
2019DDMBVE19B

126W 16000lm - 220V
DALI (Push) - 126W 16000lm - 220V

1.022,00 €
1.143,00 €

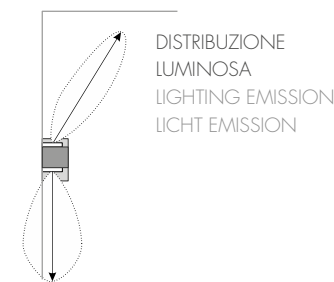

Configura 

Configure / Konfigurieren

www.teamitaliailluminazione.it 



● A 2700K ○ C 4000K

NE RU

 **CODICE COMPLETO DEL PRODOTTO NELLA FOTO**
FULL PRODUCT CODE AS SHOWN IN PICTURE - VOLLSTÄNDIGER CODE VOM ARTIKEL IM BILD

2019AOF | **RU** | **E19** | **B**

Codice
Code

Finitura
Finishing
Lackierung

Diffusore
Diffuser
Diffusor

Tonalità
Hue
Farbton

TF Taglio di Fase - Phase-Cut Dimmer - Phasenabschnittdimmer

A Alimentatore Incorporato - Incorporated Power Supply - Eingebautes Netzteil

* 2700lm effettivi - effective - effektive con - with - mit **E19**

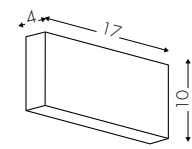

configurazione standard: / basic configuration: / Standard Konfiguration:

E19 UGR<19 - Prism ● B 3000K

BV

2019EOFUPBVE19B	7W 1100lm* - 220V	181,00 €
2019EDMUPBVE19B	DALI (Push) 7W 1100lm - 220V	229,00 €
2019ETFUPBVE19B	7W 1100lm - 220V	211,00 €

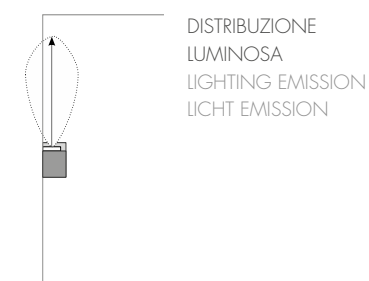

DISTRIBUZIONE
LUMINOSA
LIGHTING EMISSION
LICHT EMISSION

Configura Configure / Konfigurieren

www.teamitaliailluminazione.it

● A 2700K ○ C 4000K

NE RU

CODICE COMPLETO DEL PRODOTTO NELLA FOTO
FULL PRODUCT CODE AS SHOWN IN PICTURE - VOLLSTÄNDIGER CODE VOM ARTIKEL IM BILD

2019EOFUP **NE** **E19** **B**

Codice Code	Finitura Finishing Lackierung	Diffusore Diffuser Diffusor	Tonalità Hue Farbton
----------------	-------------------------------------	-----------------------------------	----------------------------

TF Taglio di Fase - Phase-Cut Dimmer - Phasenabschnittdimmer
A Alimentatore Incorporato - Incorporated Power Supply - Eingebautes Netzteil

* 1100lm effettivi - effective - effektive con - with - mit **E19**



configurazione standard: / basic configuration: / Standard Konfiguration:

E19 UGR<19 Prism

● B 3000K

BV

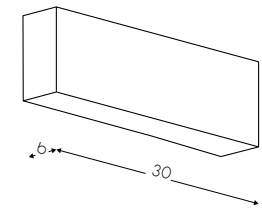

2019AOFUPBVE19B	21W 2700lm* - 220V	240,00 €
2019ADMUPBVE19B	DALI (Push) 21W 2700lm - 220V	303,00 €
2019ATFUPBVE19B	21W 2700lm - 220V	277,00 €

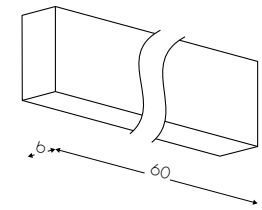

2019BOFUPBVE19B	42W 5300lm - 220V	387,00 €
2019BDMUPBVE19B	DALI (Push) 42W 5300lm - 220V	466,00 €
2019BTFUPBVE19B	42W 5300lm - 220V	466,00 €

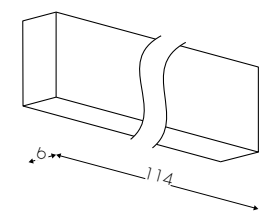

2019COFUPBVE19B	84W 10800lm - 220V	674,00 €
2019CDMUPBVE19B	DALI (Push) 84W 10800lm - 220V	738,00 €
2019COFUPEMBVB	84W 10800lm - 220V	913,00 €

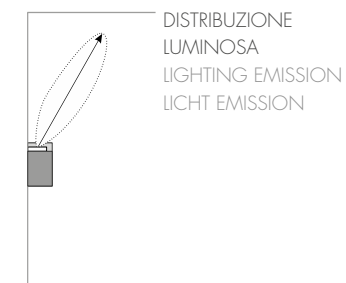

Configura

Configure / Konfigurieren

www.teamitaliailluminazione.it



● A 2700K ○ C 4000K

NE RU

CODICE COMPLETO DEL PRODOTTO NELLA FOTO
FULL PRODUCT CODE AS SHOWN IN PICTURE - VOLLSTÄNDIGER CODE VOM ARTIKEL IM BILD

2019BOFUP **NE** **E19** **B**

Codice Code	Finitura Finishing Lackierung	Diffusore Diffuser Diffusor	Tonalità Hue Farbton
----------------	-------------------------------------	-----------------------------------	----------------------------

EM Emergenza - Emergency - Notbeleuchtung
TF Taglio di Fase - Phase-Cut Dimmer - Phasenabschrittdimmer
A Alimentatore Incorporato - Incorporated Power Supply - Eingebautes Netzteil

* 2700lm effettivi - effective - effektive con - with - mit **E19**



configurazione standard: / basic configuration: / Standard Konfiguration:

BV

E2 Opale - Opal ● B 3000K

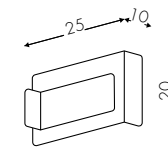

D7000FBVE2B	13W 1800lm* - 220V	270,00 €
D700TFBVE2B	13W 1800lm - 220V	315,00 €

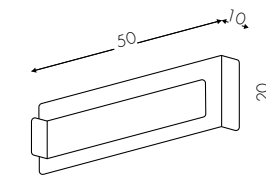

D7020FBVE2B	21W 2800lm - 220V	380,00 €
D7020DMBVE2B	DALI (Push) - 21W 2800lm - 220V	455,00 €

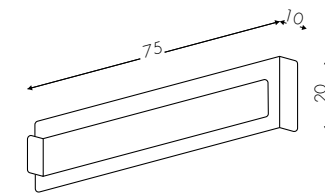

D7030FBVE2B	29W 4000lm - 220V	551,00 €
D7030DMBVE2B	DALI (Push) - 29W 4000lm - 220V	618,00 €

Configura Configure / Konfigurieren

www.teamitaliailluminazione.it



● A 2700K



CODICE COMPLETO DEL PRODOTTO NELLA FOTO
FULL PRODUCT CODE AS SHOWN IN PICTURE - VOLLSTÄNDIGER CODE VOM ARTIKEL IM BILD

D7000F **ON** **E2** **A**

Codice Code	Finitura Finishing Lackierung	Diffusore Diffuser Diffusor	Tonalità Hue Farbton
----------------	-------------------------------------	-----------------------------------	----------------------------

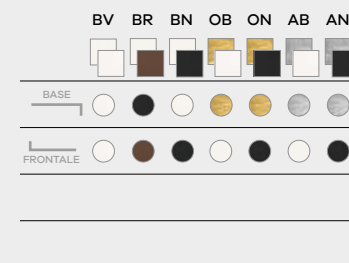

TF Taglio di Fase - Phase-Cut Dimmer - Phasenabschnittdimmer
A Alimentatore Incorporato - Incorporated Power Supply - Eingebautes Netzteil

* 1800lm effettivi - effective - effektive con - with - mit **E2**



configurazione standard: / basic configuration: / Standard Konfiguration:

E28 Satinato
Frosted - Satinert

B 3000K

BV

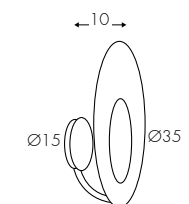

2038AOFBVE28B

15W 1900lm* - 220V

407,00 €

2038ADMBVE28B

DALI (Push) - 15W 1900lm - 220V

478,00 €

2038ATFBVE28B

15W 1900lm - 220V

478,00 €

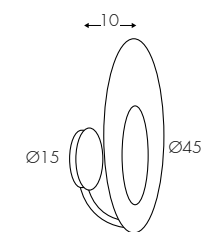

2038BOFBVE28B

18W 2600lm - 220V

464,00 €

2038BDMBVE28B

DALI (Push) - 18W 2600lm - 220V

531,00 €

2038BTFBVE28B

18W 2600lm - 220V

531,00 €

Configura

Configure / Konfigurieren

www.teamitaliailluminazione.it



A 2700K



CODICE COMPLETO DEL PRODOTTO NELLA FOTO
FULL PRODUCT CODE AS SHOWN IN PICTURE - VOLLSTÄNDIGER CODE VOM ARTIKEL IM BILD

2038AOF **BV** **E28** **B**

Codice
Code

Finitura
Finishing
Lackierung

Diffusore
Diffuser
Diffusor

Tonalità
Hue
Farbton

TF Taglio di Fase - Phase-Cut Dimmer - Phasenabschnittdimmer

A Alimentatore Incorporato - Incorporated Power Supply - Eingebautes Netzteil

* 1900lm effettivi - effective - effektive con - with - mit **E28**

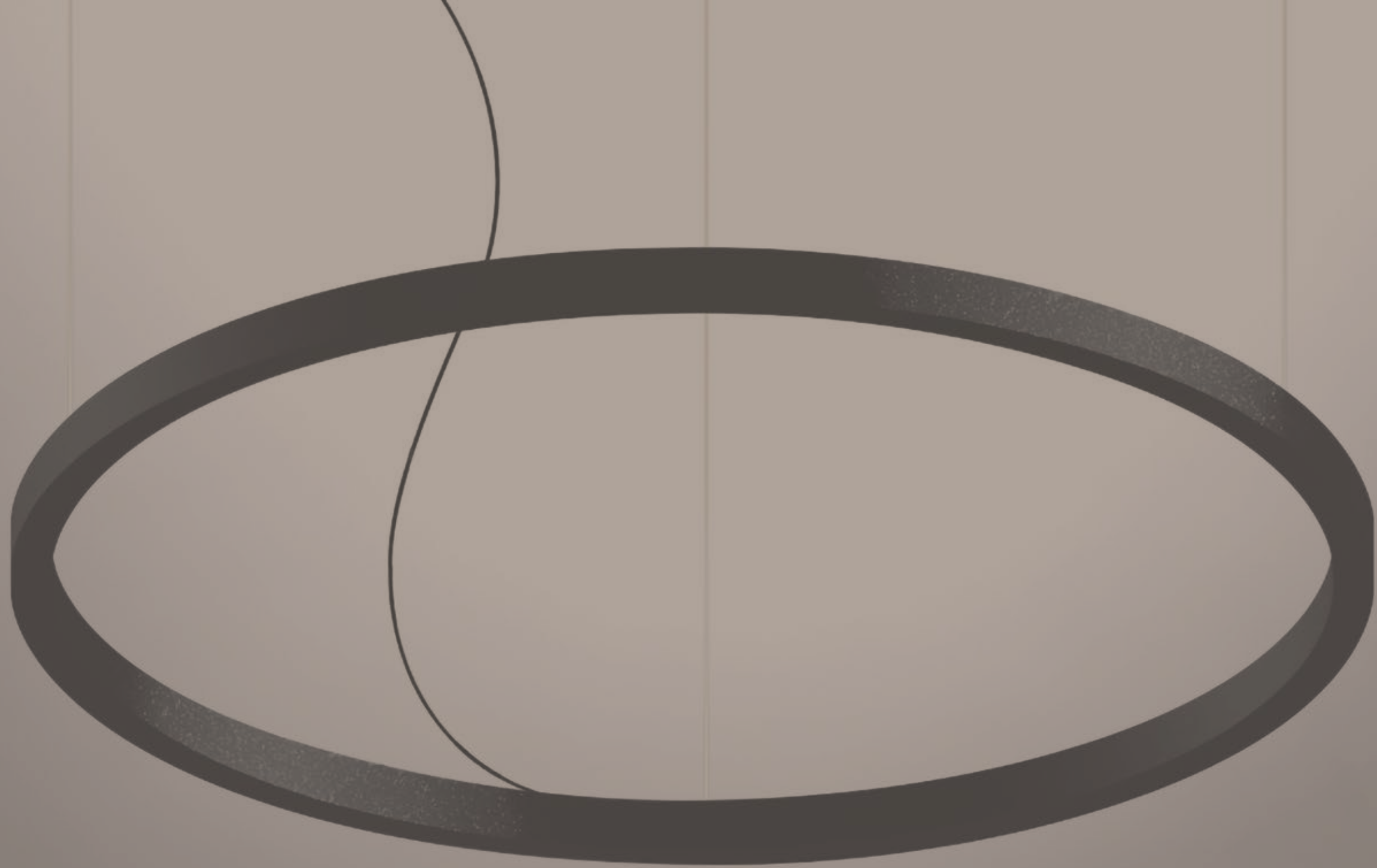

SOSPENSIONE
SUSPENSION LAMP
PENDELLEUCHE





Bellai
up+downlight Ø70/Ø95/Ø130



Bellai
up+downlight Ø180



Bellai
up+downlight Ø260



Bellai Home
up+downlight Ø58/Ø70/Ø95/Ø130/Ø180



Curve
downlight L130/L165/L270

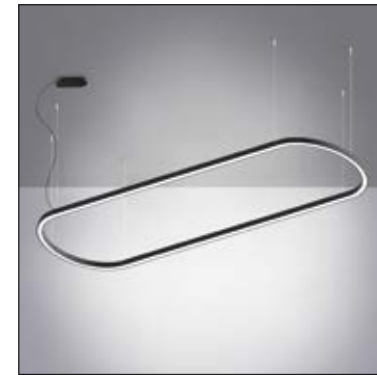

Emme24
downlight 92x345



Emme24
downlight 260X260



Kasaa
downlight Ø40/Ø55 versione singola

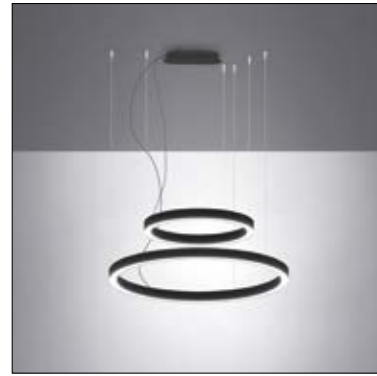

Bellai Home
up+downlight composizione
Ø58+Ø70 / Ø58+Ø95



Bellai Up
uplight Ø130/Ø185



Bulbe
downlight Ø15/Ø20 versione singola



Bulbe
downlight Ø15/Ø20 composizione circolare



Lambda
downlight Ø20/Ø30 versione singola



Lambda
downlight Ø20/Ø30
versione singola decentrata



Lambda
downlight Ø20/Ø30
composizione decentrata 2x



Lambda
downlight Ø20 composizione lineare 3x



Chapeau
downlight Ø42



Chapeau
downlight Ø60



Edge
downlight L116/L144/L242/L285



Edge
downlight L59x59/L87x87/L115x115



Lambda
downlight Ø20 composizione lineare 4x



Lambda
downlight Ø20 composizione circolare 3x



Lambda
downlight Ø20 composizione circolare 6x



Edge
downlight L115x31/L143x59/L227x87



Edge
uplight L59x59/L87x87



Edge
uplight L143x59



Edge
up+downlight composizione
L145x59/L170x103/L227x131

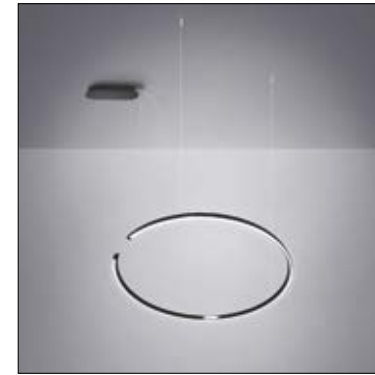

Leggera
downlight Ø65/Ø82/Ø110/Ø160



Leggera
downlight Ø65+Ø82



Leggera
downlight Ø65+Ø82+Ø110



Mellow 121
downlight Ø15 H28 versione singola



Mellow 121
downlight Ø15 H28 composizione 3x



Mellow 121
downlight Ø15 H28 composizione 6x



Sampling 147
Venis Lambda & Licis



Ogis 125
downlight Ø13,5 H15 versione singola



Ogis 125
downlight Ø13,5 H15 composizione 4x



Ogis 125
downlight Ø13,5 H15 composizione 6x



Licis 109
downlight Ø20 versione singola



Licis 109
downlight Ø20 composizione decentrata 1x



Licis 111
downlight Ø20 composizione decentrata 2x



Licis 111
downlight Ø20 composizione decentrata 3x



Oki 127
downlight 8x8 13W



Oki 127
2x downlight 8x8 13W



Omnia 129
downlight L112/L168/L225



Omnia 131
downlight tunable white L112/L225



Licis 113
downlight Ø20 composizione lineare 3x



Licis 113
downlight Ø20 composizione lineare 4x



Licis 115
downlight Ø20 composizione circolare 3x



Licis 115
downlight Ø20 composizione circolare 6x



Overlap 2.0 135
orientabile L120/L153/L250



Overlap Decò 137
up+downlight 75x133



Overlap Decò 137
up+downlight 94,5x94,5



Overlap Decò 137
up+downlight 87x184



Lieve 117
downlight L95/L125/L155



Linea Dark 119
up+downlight L95/L120/L150



Mirò Home 123
up + down + spotlight



Riflessa 141
uplight L124/L208/L292



Riflessa 143
uplight + darklight L124/L208/L292



Riflessa 145
uplight + spotlight L124/L208/L292



Pleni 139
downlight Ø38/Ø58/Ø88



Shadow 149
orizzontale Ø70/Ø95/Ø130



Shadow 151
composizione Ø70+Ø95/Ø95+Ø130



Shape 153
up+downlight L55x55/L85x85/L130x130

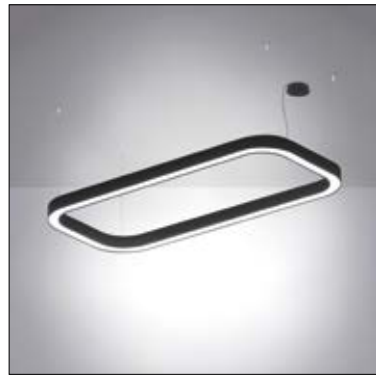

Shape 155
up+downlight L183x85



S-Pot Home 157
downlight Ø5,4 L15/L30 - GU10



S-Pot Home 157
downlight Ø5,4 L60 - GU10



S-Pot 159
downlight Ø11 L12-17W/L22-26W



Tubico 161
downlight versione singola



Tubico 163
downlight versione singola decentrata



Tubico 163
downlight composizione decentrata 2x



Tubico 163
downlight composizione decentrata 3x



Velata 169
uplight Ø58/Ø73/Ø95



Tubico 165
downlight composizione lineare 3x



Tubico 165
downlight composizione lineare 5x



Tubico 165
downlight composizione lineare 6x



Venis 171
downlight Ø20 versione singola



Venis 173
downlight Ø20 composizione decentrata 1x



Venis 173
downlight Ø20 composizione decentrata 2x



Venis 173
downlight Ø20 composizione decentrata 3x



Tubico 167
downlight composizione circolare 4x



Tubico 167
downlight composizione circolare 6x



Tubico 167
downlight composizione circolare 12x



Venis 175
downlight Ø20 composizione lineare 3x



Venis 175
downlight Ø20 composizione lineare 4x



Venis 177
downlight Ø20 composizione circolare 3x



Venis 177
downlight Ø20 composizione circolare 6x



configurazione standard: / basic configuration: / Standard Konfiguration:

E2 Opal

● B 3000K

BV

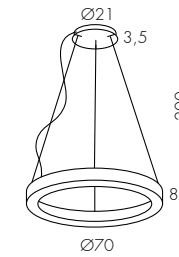

1025AOFBVE2B

50W 3810lm* + 14W 2400lm - 220V

1.025,00 €

1025ADMBVE2B

DALI (Push) - 50W 3810lm + 14W 2400lm - 220V

1.154,00 €

1025AOFEMBVE2B

50W 3810lm + 14W 2400lm - 220V

1.215,00 €

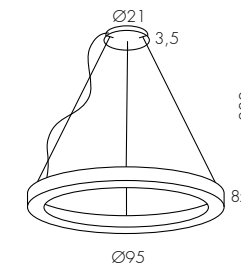

1025BOFBVE2B

65W 5170lm + 14W 2400lm - 220V

1.409,00 €

1025BDMBVE2B

DALI (Push) - 65W 5170lm + 14W 2400lm - 220V

1.568,00 €

1025BOFEMBVE2B

65W 5170lm + 14W 2400lm - 220V

1.596,00 €

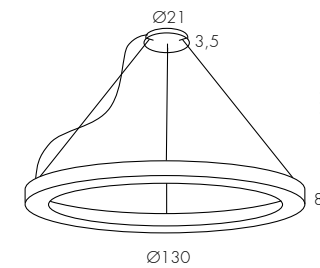

1025COFBVE2B

92W 7350lm + 24W 3600lm - 220V

2.130,00 €

1025CDMBVE2B

DALI (Push) - 92W 7350lm + 24W 3600lm - 220V

2.325,00 €

1025CBTBVE2B

Bluetooth 92W 7350lm + 24W 3600lm - 220V

2.468,00 €

1025COFEMBVE2B

92W 7350lm + 24W 3600lm - 220V

2.314,00 €

Configura

Configure / Konfigurieren

www.teamitaliailluminazione.it



E19 UGR<19 Prism

● A 2700K ○ C 4000K

NE RU



CODICE COMPLETO DEL PRODOTTO NELLA FOTO
FULL PRODUCT CODE AS SHOWN IN PICTURE - VOLLSTÄNDIGER CODE VOM ARTIKEL IM BILD

1025BOF

Codice
Code

BV

Finitura
Finishing
Lackierung

E19

Diffusore
Diffuser
Diffusor

B

Tonalità
Hue
Farbton

BV NE RU

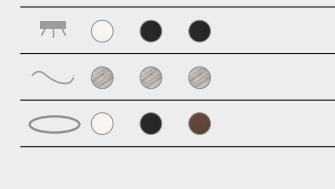

EM Emergenza - Emergency - Notbeleuchtung

BT Bluetooth - Bluetooth - Bluetooth

A Alimentatore Incorporato - Incorporated Power Supply - Eingebautes Netzteil

* 3810lm effettivi - effective - effektive con - with - mit **E2**
4480lm effettivi - effective - effektive con - with - mit **E19** ↻ +17,5%

INDEX

SECTION

FAMILY



BELLAI

SOSPENSIONE
SUSPENSION LAMP
PENDELLEUCHE



configurazione standard: / basic configuration: / Standard Konfiguration:

E2 Opale - Opal

B 3000K

BV

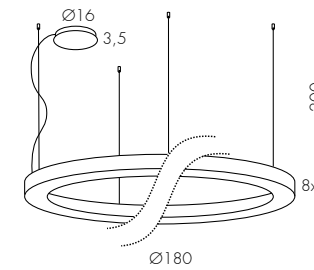

1025DOFBVE2B

160W 12950lm* + 52W 7200lm - 220V

3.009,00 €

1025DDMBVE2B

DALI (Push) - 160W 12950lm + 52W 7200lm - 220V

3.219,00 €

1025DOFEMBVE2B

160W 12950lm + 52W 7200lm - 220V

3.194,00 €

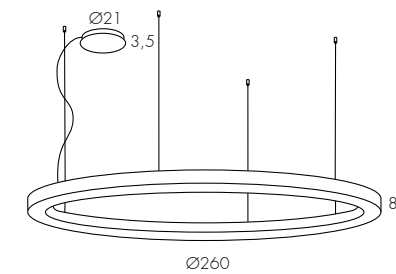

1025EOFBVE2B

250W 24000lm + 70W 9600lm - 220V

4.625,00 €

1025EDMBVE2B

DALI (Push) - 250W 24000lm + 70W 9600lm - 220V

5.124,00 €

1025EOFEMBVE2B

250W 24000lm + 70W 9600lm - 220V

4.80900 €

Configura

Configure / Konfigurieren

www.teamitaliailluminazione.it



E19 UGR<19 Prism

A 2700K C 4000K

NE RU

CODICE COMPLETO DEL PRODOTTO NELLA FOTO
FULL PRODUCT CODE AS SHOWN IN PICTURE - VOLLSTÄNDIGER CODE VOM ARTIKEL IM BILD

1025DOF

BV

E2

A

Codice
Code

Finitura
Finishing
Lackierung

Diffusore
Diffuser
Diffusor

Tonalità
Hue
Farbton

BV NE RU

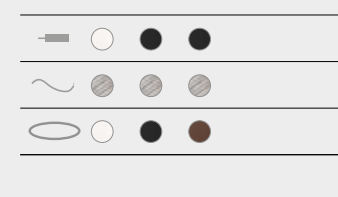

EM Emergenza - Emergency - Notbeleuchtung

A Alimentatore Incorporato - Incorporated Power Supply - Eingebautes Netzteil

* 12950lm effettivi - effective - effektive con - with - mit **E2**

15200lm effettivi - effective - effektive con - with - mit **E19** **+17,5%**

INDEX

SECTION

FAMILY



configurazione standard: / basic configuration: / Standard Konfiguration:

E2 Opale - Opal

B 3000K

BV

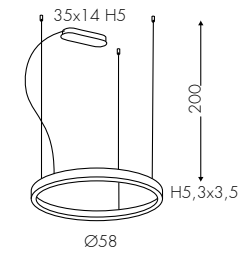

1027EOFBVE2B
1027EDMBVE2B
1027ETFBVE2B

42W 3247lm* + 24W 2400lm - 220V
DALI (Push) - 42W 3247lm + 24W 2400lm - 220V
42W 3247lm + 24W 2400lm - 220V

712,00 €
821,00 €
821,00 €

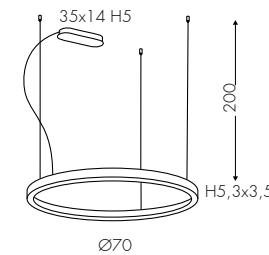

1027AOFBVE2B
1027ADMBVE2B
1027ABTBVE2B

50W 3808lm + 24W 2400lm - 220V
DALI (Push) - 50W 3808lm + 24W 2400lm - 220V
Bluetooth 50W 3808lm + 24W 2400lm - 220V

849,00 €
940,00 €
940,00 €

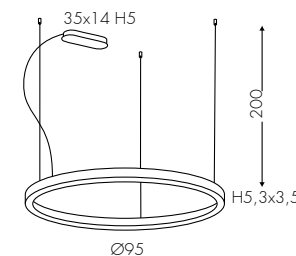

1027BOFBVE2B
1027BDMBVE2B
1027BTBVE2B

65W 5168lm + 24W 2400lm - 220V
DALI (Push) - 65W 5168lm + 24W 2400lm - 220V
Bluetooth 65W 5168lm + 24W 2400lm - 220V

1.091,00 €
1.213,00 €
1.213,00 €

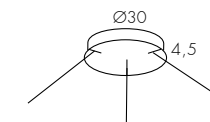

VA003E

Variazione: sostituzione con rosone centrale Ø30cm
Variation: substitution with central ceiling rose Ø30cm
Variante: Ersatz durch zentrale Deckenrose Ø30cm

+100,00 €

Configura

Configure / Konfigurieren

www.teamitaliailluminazione.it



A

E19 UGR<19 Prism

A 2700K

NE RU



BV NE RU

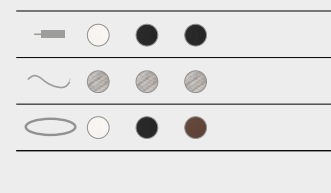

TF Taglio di Fase - Phase-Cut Dimmer - Phasenabschnittdimmer

A Alimentatore nel rosone - Power Supply inside the ceiling rose - Netzteil in der Deckendose

BT Bluetooth - Bluetooth - Bluetooth

* 3247lm effettivi - effective - effektive con - with - mit **E2**
3820lm effettivi - effective - effektive con - with - mit **E19** **+17,5%**

INDEX

SECTION

FAMILY

65



BR custom finish

CODICE COMPLETO DEL PRODOTTO NELLA FOTO
FULL PRODUCT CODE AS SHOWN IN PICTURE - VOLLSTÄNDIGER CODE VOM ARTIKEL IM BILD

1027EOF **BR** **E2** **B**

Codice
Code

Finitura
Finishing
Lackierung

Diffusore
Diffuser
Diffusor

Tonalità
Hue
Farbton





configurazione standard: / basic configuration: / Standard Konfiguration:

E2 Opale - Opal

B 3000K

BV

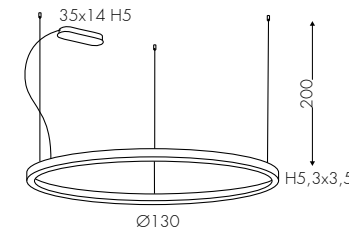

1027COFBVE2B
1027CDMBVE2B
1027CBTBVE2B

92W 7352lm* + 29W 3600lm - 220V
DALI (Push) - 92W 7352lm + 29W 3600lm - 220V
Bluetooth 92W 7352lm + 29W 3600lm - 220V

1.697,00 €
1.839,00 €
1.839,00 €

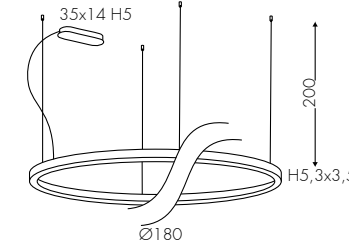

1027DOFBVE2B
1027DDMBVE2B

110W 8755lm + 35W 5250lm - 220V
DALI (Push) - 110W 8755lm + 35W 5250lm - 220V

2.329,00 €
2.592,00 €

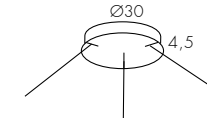

VA003E

Variation: sostituzione con rosone centrale Ø30cm
Variation: substitution with central ceiling rose Ø30cm
Variante: Ersatz durch zentrale Deckenrose Ø30cm

100,00 €

Configura

Configure / Konfigurieren

www.teamitaliailluminazione.it



A

E19 UGR<19 Prism

A 2700K

NE RU

CODICE COMPLETO DEL PRODOTTO NELLA FOTO
FULL PRODUCT CODE AS SHOWN IN PICTURE - VOLLSTÄNDIGER CODE VOM ARTIKEL IM BILD

1027COF **BV** **E2** **B**

Codice
Code

Finitura
Finishing
Lackierung

Diffusore
Diffuser
Diffusor

Tonalità
Hue
Farbton

BV NE RU



A Alimentatore nel rosone - Power Supply inside the ceiling rose - Netzteil in der Deckendose

BT Bluetooth - Bluetooth - Bluetooth

* 7352lm effettivi - effective - effektive con - with - mit **E2**
8650lm effettivi - effective - effektive con - with - mit **E19** **+17,5%**



configurazione standard: / basic configuration: / Standard Konfiguration:

E2 Opale - Opal

● B 3000K

BV

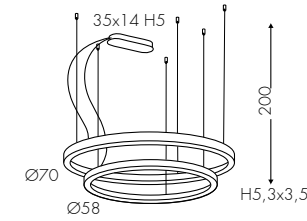

1027AEOFBVE2B
1027AEDMBVE2B
1027AEBTBVE2B

92W 7055lm* + 48W 4800lm - 220V
DALI (Push) - 92W 7055lm + 48W 4800lm - 220V
Bluetooth 92W 7055lm + 48W 4800lm - 220V

1.625,00 €
1.830,00 €
1.830,00 €

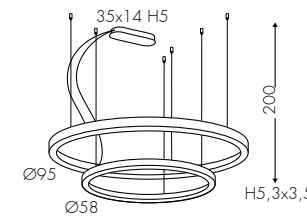

1027BEOFBVE2B
1027BEDMBVE2B
1027BEBTBVE2B

115W 9350lm + 48W 4800lm - 220V
DALI (Push) - 115W 9350lm + 48W 4800lm - 220V
Bluetooth 115W 9350lm + 48W 4800lm - 220V

1.908,00 €
2.088,00 €
2.228,00 €

Configura

Configure / Konfigurieren

www.teamitaliailluminazione.it



A

E19 UGR<19 Prism

● A 2700K

NE RU

CODICE COMPLETO DEL PRODOTTO NELLA FOTO
FULL PRODUCT CODE AS SHOWN IN PICTURE - VOLLSTÄNDIGER CODE VOM ARTIKEL IM BILD

1027BEOF **OV** **E2** **B**

Codice
Code

Finitura
Finishing
Lackierung

Diffusore
Diffuser
Diffusor

Tonalità
Hue
Farbton

BV NE RU

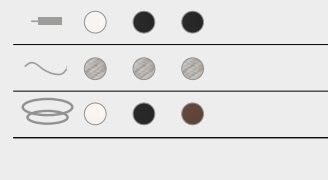

A Alimentatore nel rosone - Power Supply inside the ceiling rose - Netzteil in der Deckendose
BT Bluetooth - Bluetooth - Bluetooth

* 7055lm effettivi - effective - effektive con - with - mit **E2**
8300lm effettivi - effective - effektive con - with - mit **E19** ↻ +17,5%

BELLAI UP

SOSPENSIONE
SUSPENSION LAMP
PENDELLEUCHE



configurazione standard: / basic configuration: / Standard Konfiguration:

E28 Satinato
Frosted - Satiniert

B 3000K

BV

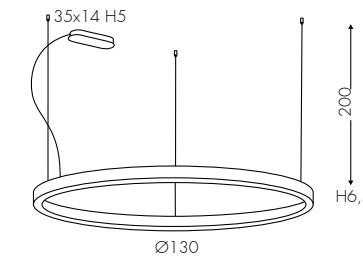

1040COFBVE28B
1040CDMBVE28B

115W 13000lm* - 220V
DALI (Push) - 115W 13000lm - 220V

2.094,00 €
2.277,00 €

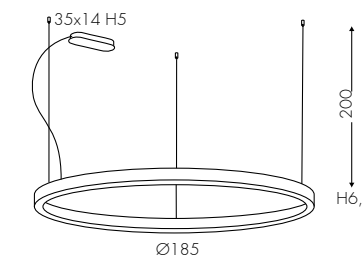

1040DOFBVE28B
1040DDMBVE28B

145W 16000lm - 220V
DALI (Push) - 145W 16000lm - 220V

2.874,00 €
3.100,00 €

Configura

Configure / Konfigurieren

www.teamitaliailluminazione.it

A

A 2700K **C** 4000K

NE RU

CODICE COMPLETO DEL PRODOTTO NELLA FOTO
FULL PRODUCT CODE AS SHOWN IN PICTURE - VOLLSTÄNDIGER CODE VOM ARTIKEL IM BILD

1040COF **NE** **E28** **B**

Codice
Code

Finitura
Finishing
Lackierung

Diffusore
Diffuser
Diffusor

Tonalità
Hue
Farbton

BV NE RU



A Alimentatore nel rosone - Power Supply inside the ceiling rose - Netzteil in der Deckendose

* 13000lm effettivi - effective - effektive con - with - mit **E28**

INDEX

SECTION

FAMILY 71

BULBE

SOSPENSIONE
SUSPENSION LAMP
PENDELLEUCHE



configurazione standard: / basic configuration: / Standard Konfiguration:



GU10

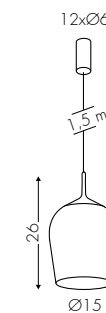

1078AOB

1x GU10 max 7W LED - 220V

240,00 €

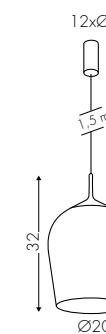

1078BOB

1x GU10 max 7W LED - 220V

275,00 €

Configura

Configure / Konfigurieren

www.teamitaliailluminazione.it



CODICE COMPLETO DEL PRODOTTO NELLA FOTO
FULL PRODUCT CODE AS SHOWN IN PICTURE - VOLLSTÄNDIGER CODE VOM ARTIKEL IM BILD

1078B

Codice
Code

ZN

Finitura
Finishing
Lackierung



GU10 Sorgente GU10 non inclusa - GU10 light source not included - GU10 Lichtquelle nicht enthalten

INDEX

SECTION

FAMILY 73



BULBE

SOSPENSIONE (composizione)
SUSPENSION (composition)
SUSPENSION (composition)



configurazione standard: / basic configuration: / Standard Konfiguration:

GU10

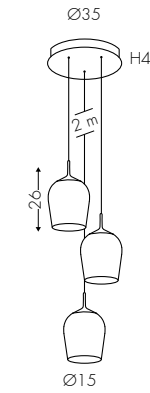

1078FOB

3x GU10 max 7W LED - 220V

720,00 €

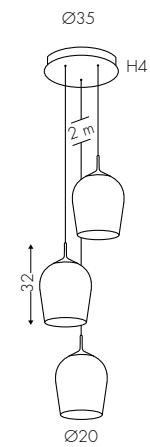

1078GOB

3x GU10 max 7W LED - 220V

825,00 €

Configura

Configure / Konfigurieren

www.teamitaliailluminazione.it



CODICE COMPLETO DEL PRODOTTO NELLA FOTO
FULL PRODUCT CODE AS SHOWN IN PICTURE - VOLLSTÄNDIGER CODE VOM ARTIKEL IM BILD

1078F

Codice
Code

BB

Finitura
Finishing
Lackierung

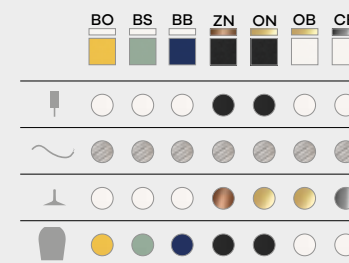

GU10 Sorgente GU10 non inclusa - GU10 light source not included - GU10 Lichtquelle nicht enthalten

INDEX

SECTION

FAMILY 75

CHAPEAU

SOSPENSIONE
SUSPENSION LAMP
PENDELLEUCHE



configurazione standard: / basic configuration: / Standard Konfiguration:

E2 Opale - Opal

● B 3000K

BV



1087BTFBVE2B

18W 1620lm* - 220V

430,00 €

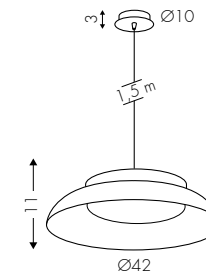

1087DTFBVE2B

30W 3000lm - 220V

560,00 €

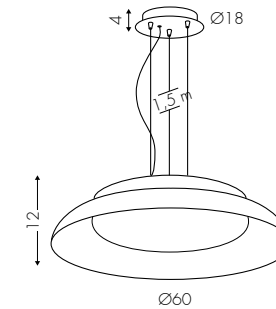

Configura

Configure / Konfigurieren

www.teamitaliailluminazione.it



CODICE COMPLETO DEL PRODOTTO NELLA FOTO
FULL PRODUCT CODE AS SHOWN IN PICTURE - VOLLSTÄNDIGER CODE VOM ARTIKEL IM BILD

1087BTF **RV** **E2** **B**

Codice
Code

Finitura
Finishing
Lackierung

Diffusore
Diffuser
Diffusor

Tonalità
Hue
Farbton

BV NE OV RV BR SV BY OC

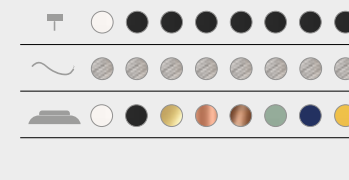

TF Taglio di Fase - Phase-Cut Dimmer - Phasenabschnittdimmer

A Alimentatore Incorporato - Incorporated Power Supply - Eingebautes Netzteil

* 1620lm effettivi - effective - effektiven con - with - mit **E2**

INDEX

SECTION

FAMILY

CURVE

SOSPENSIONE
SUSPENSION LAMP
PENDELLEUCHE



configurazione standard: / basic configuration: / Standard Konfiguration:

E2 Opale - Opal

● B 3000K

BV

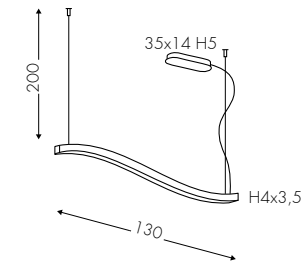

1022NOFBVE2B
1022NDMBVE2B
1022NTFBVE2B

35W 3570lm* - 220V
DALI (Push) - 35W 3570lm - 220V
35W 3570lm - 220V

568,00 €
680,00 €
620,00 €

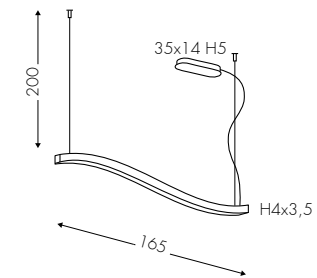

1022MOFBVE2B
1022MDMBVE2B
1022MTFBVE2B

45W 4675lm - 220V
DALI (Push) - 45W 4675lm - 220V
45W 4675lm - 220V

625,00 €
710,00 €
662,00 €

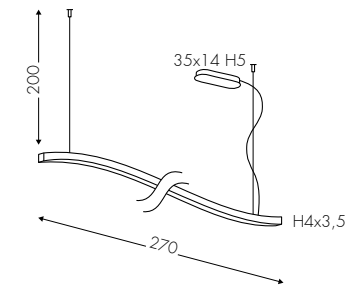

1022HOFBVE2B
1022HDMBVE2B

70W 7565lm - 220V
DALI (Push) - 70W 7565lm - 220V

834,00 €
967,00 €

Configura

Configure / Konfigurieren

www.teamitaliailluminazione.it



E19 Prismatico - Prism

● A 2700K

NE RU



CODICE COMPLETO DEL PRODOTTO NELLA FOTO
FULL PRODUCT CODE AS SHOWN IN PICTURE - VOLLSTÄNDIGER CODE VOM ARTIKEL IM BILD

1022MOF **NE** **E2** **B**

Codice
Code

Finitura
Finishing
Lackierung

Diffusore
Diffuser
Diffusor

Tonalità
Hue
Farbton

BV NE RU



TF Taglio di Fase - Phase-Cut Dimmer - Phasenabschnittdimmer

A Alimentatore nel rosone - Power Supply inside the ceiling rose - Netzteil in der Deckendose

* 3570lm effettivi - effective - effektive con - with - mit **E2**
4200lm effettivi - effective - effektive con - with - mit **E19** ↻ +17,5%

INDEX

SECTION

FAMILY

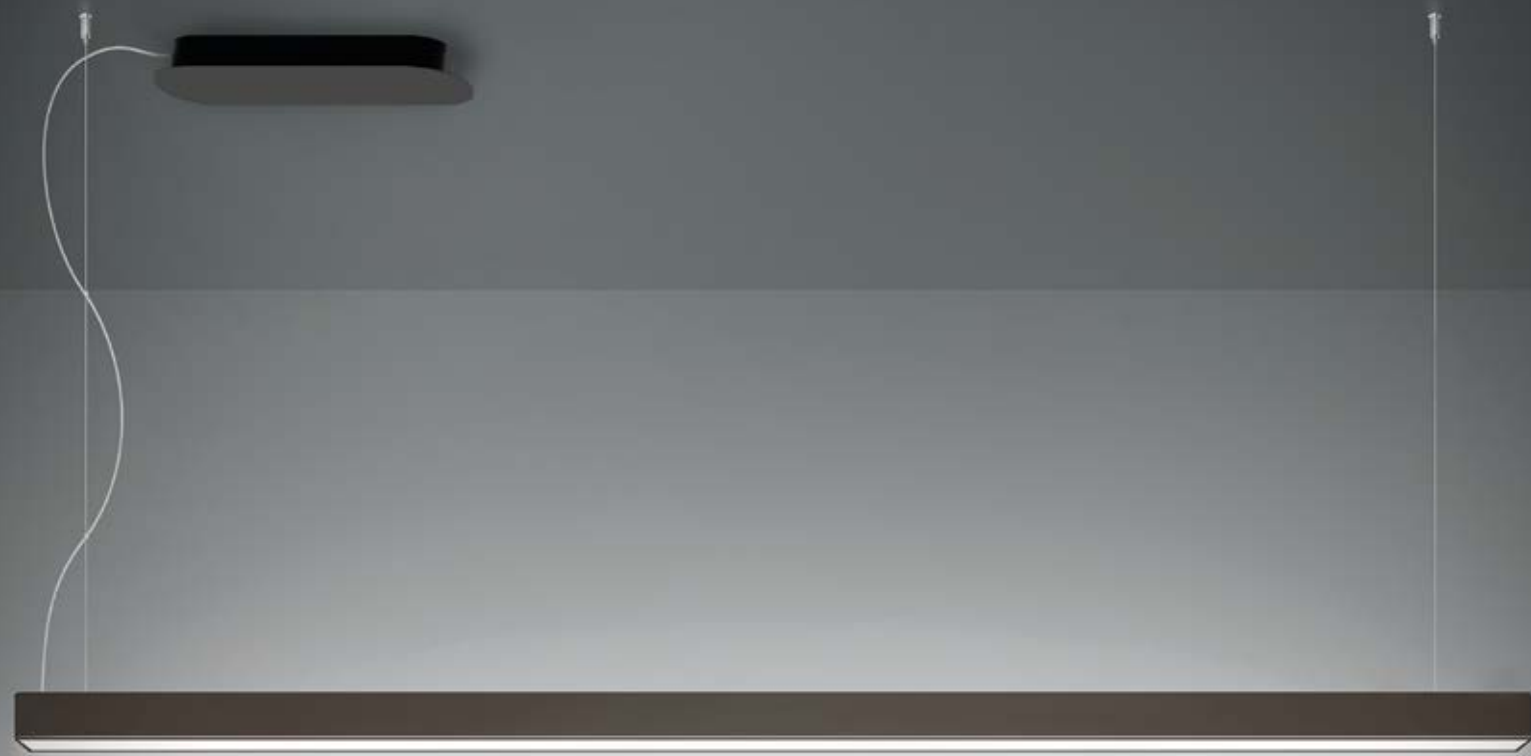

configurazione standard: / basic configuration: / Standard Konfiguration:

E2 Opale - Opal

B 3000K

BV

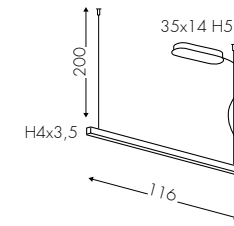

1028SOFBVE2B
1028SDMBVE2B
1028TFBVE2B

25W 2250lm* - 220V
DALI (Push) - 25W 2250lm - 220V
25W 2250lm - 220V

301,00 €
350,00 €
350,00 €

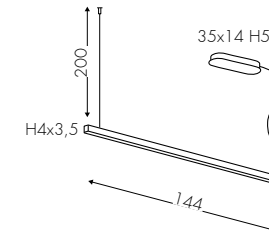

1028TOFBVE2B
1028TDMBVE2B
1028TTFBVE2B

31W 2790lm - 220V
DALI (Push) - 31W 2790lm - 220V
31W 2790lm - 220V

344,00 €
406,00 €
406,00 €

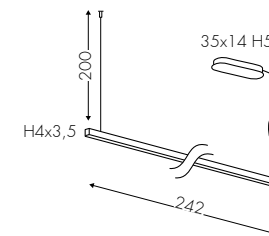

1028UOFBVE2B
1028UDMBVE2B

52W 4680lm - 220V
DALI (Push) - 52W 4680lm - 220V

457,00 €
552,00 €

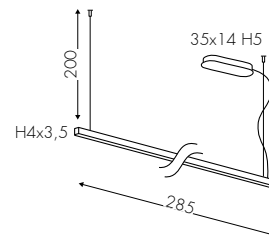

1028VOFBVE2B
1028VDMBVE2B

62W 5590lm - 220V
DALI (Push) - 62W 5590lm - 220V

665,00 €
768,00 €

Configura

Configure / Konfigurieren

www.teamitaliailluminazione.it



E19 UGR<19 Prism

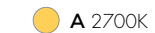

NE RU



CODICE COMPLETO DEL PRODOTTO NELLA FOTO
FULL PRODUCT CODE AS SHOWN IN PICTURE - VOLLSTÄNDIGER CODE VOM ARTIKEL IM BILD

1028TOF **NE** **E2** **B**

Codice
Code

Finitura
Finishing
Lackierung

Diffusore
Diffuser
Diffusor

Tonalità
Hue
Farbton

BV NE RU

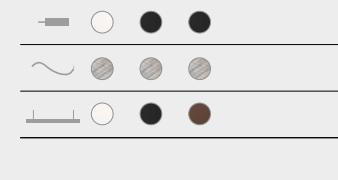

TF Taglio di Fase - Phase-Cut Dimmer - Erhältlich Phasenabschnittdimmer

A Alimentatore nel rosone - Power Supply inside the ceiling rose - Netzteil in der Deckendose

* 2250lm effettivi - effective - effektive con - with - mit **E2**
2600lm effettivi - effective - effektive con - with - mit **E19** **+17,5%**



configurazione standard: / basic configuration: / Standard Konfiguration:

E2 Opale - Opal

B 3000K

BV

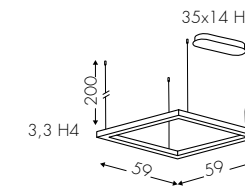

1028BOFBVE2B
1028BDMBVE2B

50W 3650lm* - 220V
DALI (Push) - 50W 3650lm - 220V

656,00 €
750,00 €

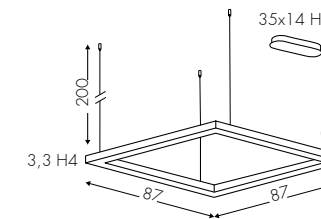

1028COFBVE2B
1028CDMBVE2B

75W 5470lm - 220V
DALI (Push) - 75W 5470lm - 220V

903,00 €
995,00 €

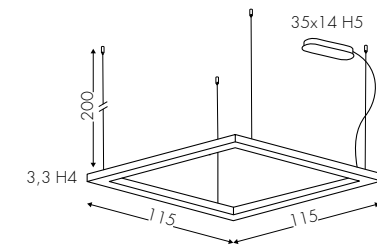

1028DOFBVE2B
1028DDMBVE2B

100W 7300lm - 220V
DALI (Push) - 100W 7300lm - 220V

1.036,00 €
1.158,00 €

Configura

Configure / Konfigurieren

www.teamitaliailluminazione.it



A

E19 UGR<19 Prism



A 2700K



C 4000K

NE RU



CODICE COMPLETO DEL PRODOTTO NELLA FOTO
FULL PRODUCT CODE AS SHOWN IN PICTURE - VOLLSTÄNDIGER CODE VOM ARTIKEL IM BILD

1028DDM **NE** **E19** **B**

Codice
Code

Finitura
Finishing
Lackierung

Diffusore
Diffuser
Diffusor

Tonalità
Hue
Farbton

BV NE RU



A Alimentatore nel rosone - Power Supply inside the ceiling rose - Netzteil in der Deckendose

* 3650lm effettivi - effective - effektive con - with - mit E2
4290lm effettivi - effective - effektive con - with - mit E19 **+17,5%**



EDGE

SOSPENSIONE
SUSPENSION LAMP
PENDELLEUCHE



configurazione standard: / basic configuration: / Standard Konfiguration:

E2 Opale - Opal ● B 3000K BV

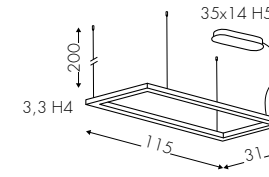

1028E0FBVE2B 62W 4560lm* - 220V **676,00 €**
1028EDMBVE2B DALI (Push) - 62W 4560lm - 220V **772,00 €**

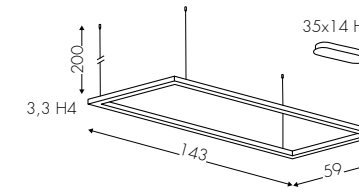

1028H0FBVE2B 88W 6420lm - 220V **1.036,00 €**
1028HDMBVE2B DALI (push) - 88W 6420lm - 220V **1.158,00 €**

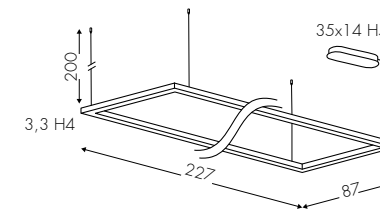

1028G0FBVE2B 138W 10020lm - 220V **1.369,00 €**
1028GDMBVE2B DALI (Push) - 138W 10020lm - 220V **1.534,00 €**

Configura Configure / Konfigurieren

www.teamitaliailluminazione.it



E19 UGR<19 Prism ● **A** 2700K **C** 4000K NE RU

A Alimentatore nel rosone - Power Supply inside the ceiling rose - Netzteil in der Deckendose

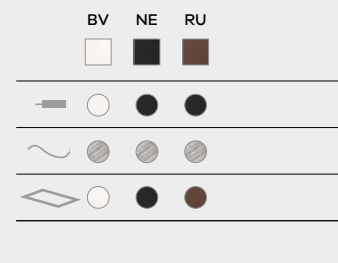

* 4560lm effettivi - effective - effektive con - with - mit **E2**
 5363lm effettivi - effective - effektive con - with - mit **E19** ↻ +17,5%

CODICE COMPLETO DEL PRODOTTO NELLA FOTO
 FULL PRODUCT CODE AS SHOWN IN PICTURE - VOLLSTÄNDIGER CODE VOM ARTIKEL IM BILD

1028GOF **NE** **E2** **B**

Codice Code
 Finitura Finishing Lackierung
 Diffusore Diffuser Diffusor
 Tonalità Hue Farbton

EDGE

SOSPENSIONE
SUSPENSION LAMP
PENDELLEUCHE



configurazione standard: / basic configuration: / Standard Konfiguration:

E28 Satinato
Frosted - Satiniert

B 3000K

BV

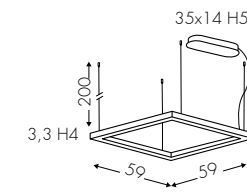

1028BUPOFBVE28B 50W 4290lm* - 220V **656,00 €**
1028BUPDMBVE28B DALI (Push) - 50W 4290lm - 220V **750,00 €**

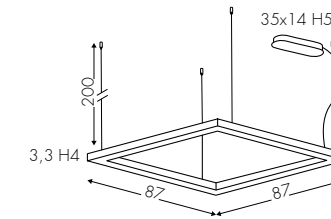

1028CUPOFBVE28B 75W 6435lm - 220V **903,00 €**
1028CUPDMBVE28B DALI (Push) - 75W 6435lm - 220V **995,00 €**

Configura Configure / Konfigurieren

www.teamitaliailluminazione.it

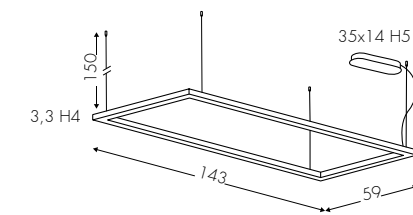

1028HUPOFBVE28B 88W 7550lm - 220V **1.036,00 €**
1028HUPDMBVE28B DALI (push) - 88W 7550lm - 220V **1.158,00 €**

Configura Configure / Konfigurieren

www.teamitaliailluminazione.it



A 2700K C 4000K

NE RU

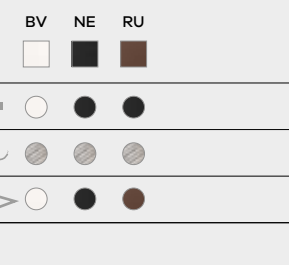

A Alimentatore nel rosone - Power Supply inside the ceiling rose - Netzteil in der Deckendose

* 4290lm effettivi - effective - effektive con - with - mit E28



CODICE COMPLETO DEL PRODOTTO NELLA FOTO
FULL PRODUCT CODE AS SHOWN IN PICTURE - VOLLSTÄNDIGER CODE VOM ARTIKEL IM BILD

1028HUPOF **NE** **E28** **B**

Codice Code
 Finitura Finishing
 Diffusore Diffuser
 Tonalità Hue
 Lackierung Diffusor Farbton



EDGE

SOSPENSIONE (composizione)
SUSPENSION (composition)
SUSPENSION (composition)



configurazione standard: / basic configuration: / Standard Konfiguration:

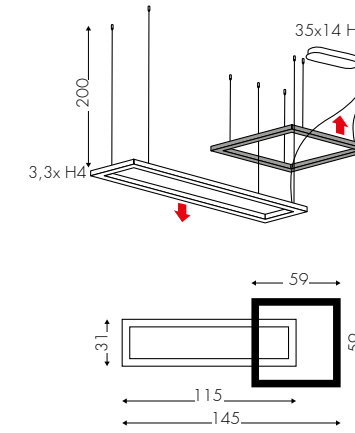

E2 Opale - Opal ● B 3000K



1028NOFBVE2B	62W 4560lm* + 50W 4290lm - 220V	1.307,00 €
1028NDMBVE2B	DALI (Push) - 62W 4560lm + 50W 4290lm - 220V	1.404,00 €
1028NBTBVE2B	Bluetooth 62W 4560lm + 50W 4290lm - 220V	1.404,00 €

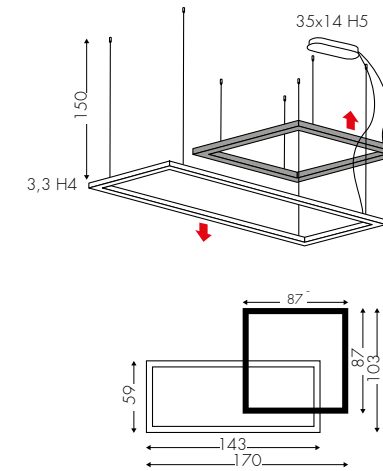

1028MOFBVE2B	75W 5470lm + 44W 3880lm - 220V	1.875,00 €
1028MDMBVE2B	DALI (Push) - 75W 5470lm + 44W 3880lm - 220V	1.989,00 €
1028MBTBVE2B	Bluetooth 75W 5470lm + 44W 3880lm - 220V	1.989,00 €

Configura Configure / Konfigurieren

www.teamitaliailluminazione.it



E19 UGR<19 Prism ● A 2700K



CODICE COMPLETO DEL PRODOTTO NELLA FOTO
FULL PRODUCT CODE AS SHOWN IN PICTURE - VOLLSTÄNDIGER CODE VOM ARTIKEL IM BILD

1028NOF **BN** **E2** **B**

Codice Code	Finitura Finishing Lackierung	Diffusore Diffuser Diffusor	Tonalità Hue Farbton
----------------	-------------------------------------	-----------------------------------	----------------------------

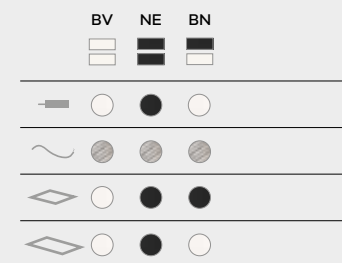

BT Bluetooth - Bluetooth - Bluetooth
A Alimentatore nel rosone - Power Supply in the ceiling rose - Netzteil in der Deckendose

* 4560lm effettivi - effective - effektive con - with - mit **E2**
5363lm effettivi - effective - effektive con - with - mit **E19** **+17,5%**



configurazione standard: / basic configuration: / Standard Konfiguration:

E2 Opale - Opal ● B 3000K

BV

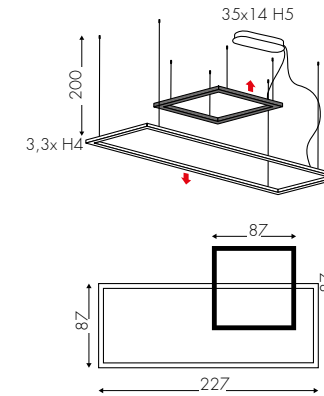

1028OOFBVE2B	96W 6955lm* + 35W 2964lm - 220V	2.316,00 €
1028ODMBVE2B	DALI (Push) - 96W 6955lm + 35W 2964lm - 220V	2.447,00 €
1028OBTBVE2B	Bluetooth 96W 6955lm + 35W 2964lm - 220V	2.447,00 €

Configura Configure / Konfigurieren

www.teamitaliailluminazione.it



E19 UGR<19 Prism ● A 2700K

NE BN

CODICE COMPLETO DEL PRODOTTO NELLA FOTO
FULL PRODUCT CODE AS SHOWN IN PICTURE - VOLLSTÄNDIGER CODE VOM ARTIKEL IM BILD

1028OOF **BN** **E2** **B**

Codice
Code

Finitura
Finishing
Lackierung

Diffusore
Diffuser
Diffusor

Tonalità
Hue
Farbton

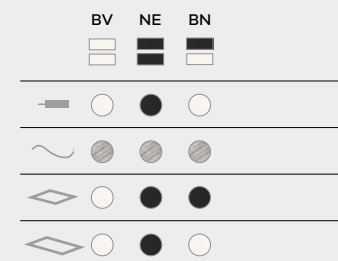

BT Bluetooth - Bluetooth - Bluetooth
A Alimentatore nel rosone - Power Supply in the ceiling rose - Netzteil in der Deckendose

* 6955lm effettivi - effective - effektive con - with - mit **E2**
8181lm effettivi - effective - effektive con - with - mit **E19** ↻ +17,5%



EMME 24

SOSPENSIONE (composizione)
SUSPENSION (composition)
SUSPENSION (composition)



configurazione standard: / basic configuration: / Standard Konfiguration:

E2 Opale - Opal ● B 3000K



1037SOFBVE2B
1037SDMBVE2B

184W 13540lm* - 220V
DALI (Push) - 184W 13540lm - 220V

2.145,00 €
2.232,00 €

Configura Configure / Konfigurieren

www.teamitaliailluminazione.it

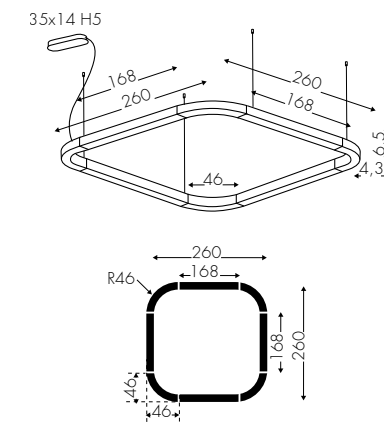
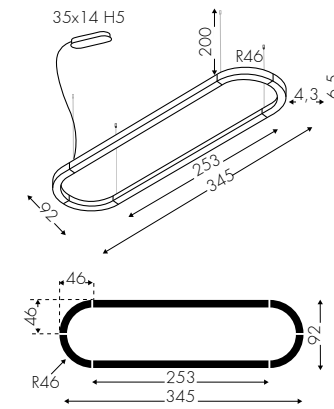

1037TOFBVE2B
1037TDMBVE2B

220W 16355lm - 220V
DALI (Push) - 220W 16355lm - 220V

2.565,00 €
2.652,00 €

Configura Configure / Konfigurieren

www.teamitaliailluminazione.it



E19 UGR<19 Prism ○ C 4000K



A Alimentatore nel rosone - Power Supply inside the ceiling rose - Netzteil in der Deckendose

* 13540lm effettivi - effective - effektive con - with - mit **E2**
15920lm effettivi - effective - effektive con - with - mit **E19** ↻ +17,5%

↑ CODICE COMPLETO DEL PRODOTTO NELLA FOTO
FULL PRODUCT CODE AS SHOWN IN PICTURE - VOLLSTÄNDIGER CODE VOM ARTIKEL IM BILD

1037SOF **NE** **E19** **B**

Codice Code	Finitura Finishing Lackierung	Diffusore Diffuser Diffusor	Tonalità Hue Farbton
----------------	-------------------------------------	-----------------------------------	----------------------------

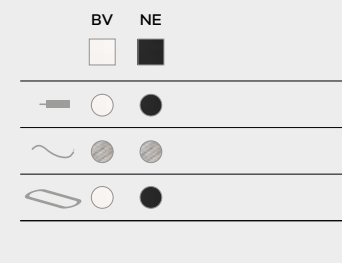



configurazione standard: / basic configuration: / Standard Konfiguration:

E2 Opale - Opal ● B 3000K

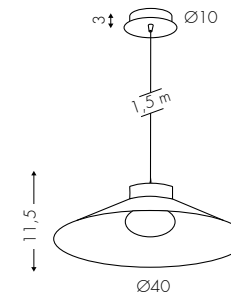

1076CTFNEE2B

17W 1100lm* - 220V

395,00 €

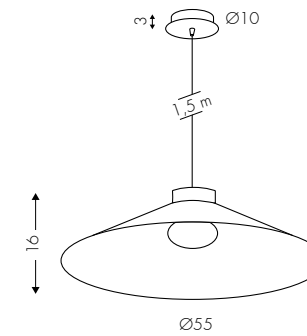

1076DTFNEE2B

17W 1100lm - 220V

480,00 €

CO05T2NE

Custom black cable

8,00 € /MT

Configura

Configure / Konfigurieren

www.teamitaliailluminazione.it



● A 2700K



CODICE COMPLETO DEL PRODOTTO NELLA FOTO
FULL PRODUCT CODE AS SHOWN IN PICTURE - VOLLSTÄNDIGER CODE VOM ARTIKEL IM BILD

1076CTF ON E2 A

Codice Code	Finitura Finishing Lackierung	Diffusore Diffuser Diffusor	Tonalità Hue Farbton
----------------	-------------------------------------	-----------------------------------	----------------------------

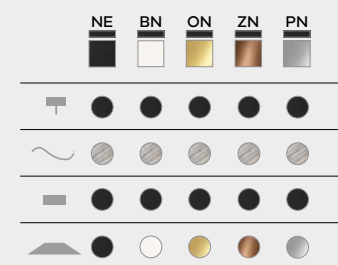

TF Taglio di Fase - Phase-Cut Dimmer - Phasenabschnittdimmer

A Alimentatore Incorporato - Incorporated Power Supply - Eingebautes Netzteil

* 1100lm effettivi - effective - effektiven con - with - mit **E2**

LAMBDA

SOSPENSIONE
SUSPENSION LAMP
PENDELLEUCHE



configurazione standard: / basic configuration: / Standard Konfiguration:

E19 Prismatico - Prism ● B 3000K ON

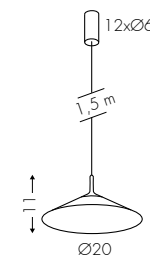

1071PTFONE19B 6,5W 800lm* - 220V **292,00 €**

1071QTFONE19B 6,5W 800lm - 220V **372,00 €**

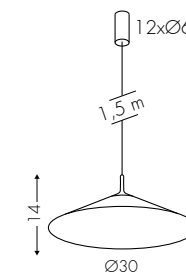

C005A2TR Custom transparent cable **7,00 € /MT**

Configura Configure / Konfigurieren

www.teamitaliailluminazione.it



● A 2700K ZN PN

CODICE COMPLETO DEL PRODOTTO NELLA FOTO
FULL PRODUCT CODE AS SHOWN IN PICTURE - VOLLSTÄNDIGER CODE VOM ARTIKEL IM BILD

1071QTF **PN** **E19** **A**

Codice
Code

Finitura
Finishing
Lackierung

Diffusore
Diffuser
Diffusor

Tonalità
Hue
Farbton

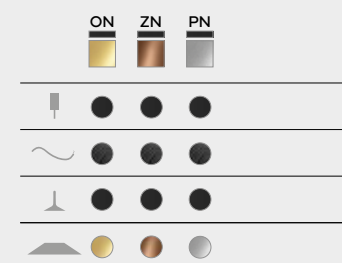

TF Taglio di Fase - Phase-Cut Dimmer - Phasenabschrittdimmer

A Alimentatore nel rosone - Power Supply inside the ceiling rose - Netzteil in der Deckendose

* 800lm effettivi - effective - effektiven con - with - mit **E19**

INDEX

SECTION

FAMILY 97

LAMBDA

SOSPENSIONE (composizione)
SUSPENSION (composition)
SUSPENSION (composition)



configurazione standard: / basic configuration: / Standard Konfiguration:

E19 Prismatico - Prism ● B 3000K



1071RTFONE19B 6,5W 800lm* - 220V

306,00 €

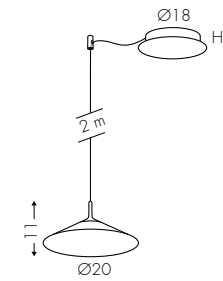

1071STFONE19B 6,5W 800lm - 220V

386,00 €

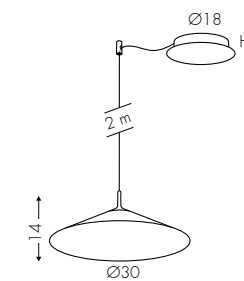

[Configura](#) Configure / Konfigurieren

www.teamitaliailluminazione.it

1071TTFONE19B 2x6,5W 2x800lm - 220V

650,00 €

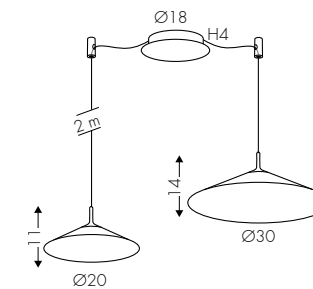

C005A2TR Custom transparent cable

7,00 € /MT

[Configura](#) Configure / Konfigurieren

www.teamitaliailluminazione.it



● A 2700K



CODICE COMPLETO DEL PRODOTTO NELLA FOTO
FULL PRODUCT CODE AS SHOWN IN PICTURE - VOLLSTÄNDIGER CODE VOM ARTIKEL IM BILD

1071TTF **PN** **E19** **B**

Codice
Code

Finitura
Finishing
Lackierung

Diffusore
Diffuser
Diffusor

Tonalità
Hue
Farbton

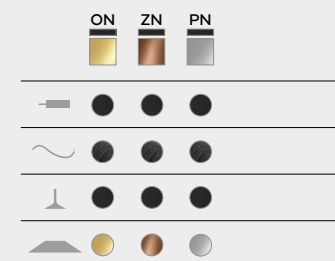

TF Taglio di Fase - Phase-Cut Dimmer - Phasenabschnittdimmer

A Alimentatore nel rosone - Power Supply inside the ceiling rose - Netzteil in der Deckendose

* 800lm effettivi - effective - effektiven con - with - mit **E19**



LAMBDA

SOSPENSIONE (composizione)
SUSPENSION (composition)
SUSPENSION (composition)



configurazione standard: / basic configuration: / Standard Konfiguration:

E19 Prismatico - Prism ● B 3000K ON

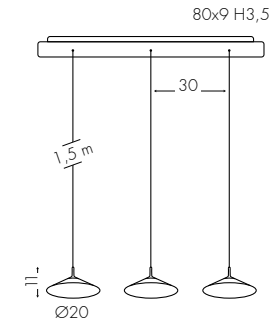

1071DTFONE19B 3x6,5W 3x800lm* - 220V

990,00 €

Configura Configure / Konfigurieren

www.teamitaliailluminazione.it

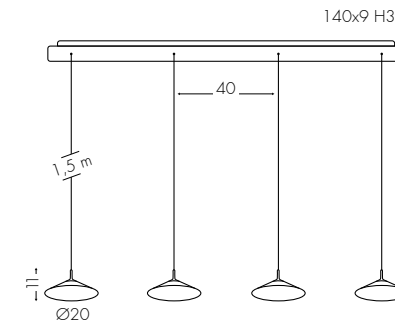

1071ETONE19B 4x6,5W 4x800lm - 220V

1.290,00 €

C005A2TR Custom transparent cable

7,00 € /MT

Configura Configure / Konfigurieren

www.teamitaliailluminazione.it



● A 2700K ZN PN

CODICE COMPLETO DEL PRODOTTO NELLA FOTO
FULL PRODUCT CODE AS SHOWN IN PICTURE - VOLLSTÄNDIGER CODE VOM ARTIKEL IM BILD

1071ETF **ON** **E19** **A**

Codice Code	Finitura Finishing Lackierung	Diffusore Diffuser Diffusor	Tonalità Hue Farbton
----------------	-------------------------------------	-----------------------------------	----------------------------

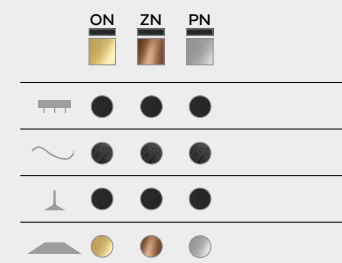

A Alimentatore nel rosone - Power Supply inside the ceiling rose - Netzteil in der Deckendose
TF Taglio di Fase - Phase-Cut Dimmer - Phasenabschrittdimmer

* 800lm effettivi - effective - effektiven con - with - mit **E19**



LAMBDA

SOSPENSIONE (composizione)
SUSPENSION (composition)
SUSPENSION (composition)



configurazione standard: / basic configuration: / Standard Konfiguration:

E19 Prismatico - Prism ● B 3000K



1071FTFONE19B 3x6,5W 3x800lm* - 220V

850,00 €

[Configura](#) Configure / Konfigurieren

www.teamitaliailluminazione.it

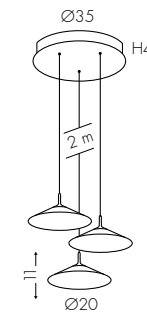

1071GTFONE19B 6x6,5W 6x800lm - 220V

1.800,00 €

C005A2TR Custom transparent cable

7,00 € /MT

[Configura](#) Configure / Konfigurieren

www.teamitaliailluminazione.it



● A 2700K



CODICE COMPLETO DEL PRODOTTO NELLA FOTO
FULL PRODUCT CODE AS SHOWN IN PICTURE - VOLLSTÄNDIGER CODE VOM ARTIKEL IM BILD

1071FGTF **ZN** **E19** **A**

Codice Code	Finitura Finishing Lackierung	Diffusore Diffuser Diffusor	Tonalità Hue Farbton
----------------	-------------------------------------	-----------------------------------	----------------------------

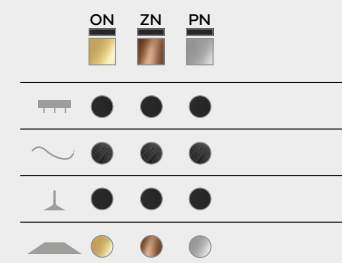

A Alimentatore nel rosone - Power Supply inside the ceiling rose - Netzteil in der Deckendose
TF Taglio di Fase - Phase-Cut Dimmer - Phasenabschrittdimmer

* 800lm effettivi - effective - effektiven con - with - mit **E19**

LEGGERA

SOSPENSIONE
SUSPENSION LAMP
PENDELLEUCHE



configurazione standard: / basic configuration: / Standard Konfiguration:

E2 Opale - Opal

● B 3000K

BV

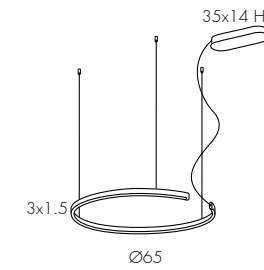

1032AOFBVE2B
1032ADMBVE2B
1032ATFBVE2B

35W 1740lm* - 220V
DALI (Push) - 35W 1740lm - 220V
35W 1740lm - 220V

656,00 €
739,00 €
739,00 €

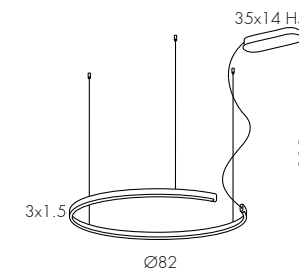

1032BOFBVE2B
1032BDMBVE2B
1032BTFBVE2B

48W 2580lm - 220V
DALI (Push) - 48W 2580lm - 220V
48W 2580lm - 220V

766,00 €
869,00 €
869,00 €

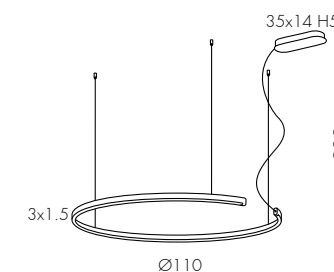

1032COFBVE2B
1032CDMBVE2B
1032CTFBVE2B

65W 3300lm - 220V
DALI (Push) - 65W 3300lm - 220V
65W 3300lm - 220V

947,00 €
1.060,00 €
1.060,00 €

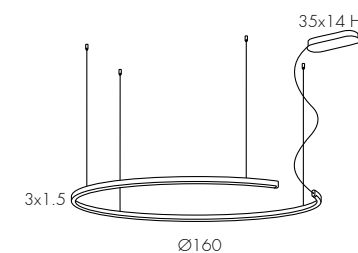

1032DOFBVE2B
1032DDMBVE2B
1032DTFBVE2B

90W 4980lm - 220V
DALI (Push) - 90W 4980lm - 220V
90W 4980lm - 220V

1.452,00 €
1.582,00 €
1.582,00 €

Configura

Configure / Konfigurieren

www.teamitaliailluminazione.it



A

E2 Opale - Opal

● A 2700K

NE RV BR OV



CODICE COMPLETO DEL PRODOTTO NELLA FOTO
FULL PRODUCT CODE AS SHOWN IN PICTURE - VOLLSTÄNDIGER CODE VOM ARTIKEL IM BILD

1032COF **BR** **E2** **B**

Codice
Code

Finitura
Finishing
Lackierung

Diffusore
Diffuser
Diffusor

Tonalità
Hue
Farbton

BV NE RV BR OV

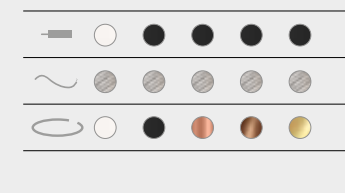

TF Taglio di Fase - Phase-Cut Dimmer - Phasenabschnittdimmer

A Alimentatore nel rosone - Power Supply inside the ceiling rose - Netzteil in der Deckendose

* 1740lm effettivi - effective - effektive con - with - mit **E2**



LEGGERA

SOSPENSIONE (composizione)
SUSPENSION (composition)
SUSPENSION (composition)



configurazione standard: / basic configuration: / Standard Konfiguration:

E2 Opale - Opal ● B 3000K

BV

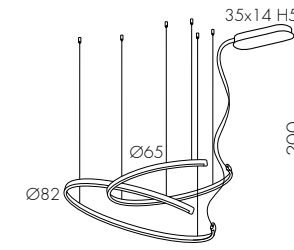

1032ABOFBVE2B	83W 4320lm* - 220V	1.506,00 €
1032ABDMBVE2B	DALI (Push) - 83W 4320lm - 220V	1.635,00 €
1032ABTFBVE2B	83W 4320lm - 220V	1.635,00 €

Configura Configure / Konfigurieren

www.teamitaliailluminazione.it

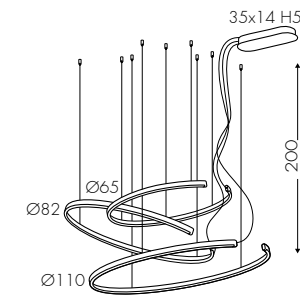

1032ABCOFBVE2B	148W 7620lm - 220V	2.434,00 €
1032ABCDMBVE2B	DALI (Push) - 148W 7620lm - 220V	2.585,00 €
1032ABCTFBVE2B	148W 7620lm - 220V	2.585,00 €

Configura Configure / Konfigurieren

www.teamitaliailluminazione.it



● A 2700K



CODICE COMPLETO DEL PRODOTTO NELLA FOTO
FULL PRODUCT CODE AS SHOWN IN PICTURE - VOLLSTÄNDIGER CODE VOM ARTIKEL IM BILD

1032ABCOF **OV** **E2** **B**

Codice Code	Finitura Finishing Lackierung	Diffusore Diffuser Diffuser	Tonalità Hue Farbton
----------------	-------------------------------------	-----------------------------------	----------------------------

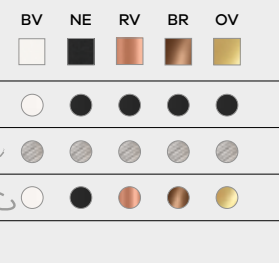

TF Taglio di Fase - Phase-Cut Dimmer - Phasenabschrittdimmer
A Alimentatore nel rosone - Power Supply inside the ceiling rose - Netzteil in der Deckendose

* 4320lm effettivi - effective - effektive con - with - mit **E2**



LICIS

SOSPENSIONE
SUSPENSION LAMP
PENDELLEUCHE



configurazione standard: / basic configuration: / Standard Konfiguration:

E2 Opale - Opal - Opal ● B 3000K



1073ATFNTE2B 6,5W 800lm* - 220V

350,00 €

Configura Configure / Konfigurieren

www.teamitaliailluminazione.it

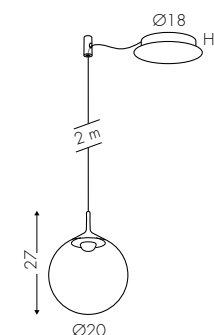
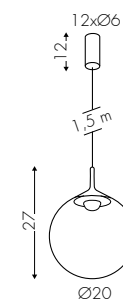

1073BTFNTE2B 6,5W 800lm - 220V

370,00 €

Configura Configure / Konfigurieren

www.teamitaliailluminazione.it



● A 2700K



CODICE COMPLETO DEL PRODOTTO NELLA FOTO
FULL PRODUCT CODE AS SHOWN IN PICTURE - VOLLSTÄNDIGER CODE VOM ARTIKEL IM BILD

1073ATF **NT** **E2** **A**

Codice
Code

Finitura
Finishing
Lackierung

Diffusore
Diffuser
Diffusor

Tonalità
Hue
Farbton

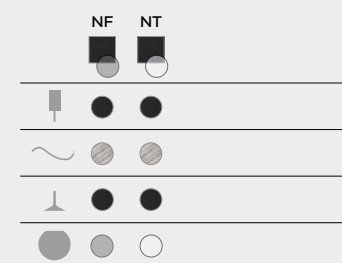

TF Taglio di Fase - Phase-Cut Dimmer - Phasenabschnittdimmer

A Alimentatore nel rosone - Power Supply inside the ceiling rose - Netzteil in der Deckendose

* 800lm effettivi - effective - effektive con - with - mit **E2**



LICIS

SOSPENSIONE (composizione)
SUSPENSION (composition)
SUSPENSION (composition)



configurazione standard: / basic configuration: / Standard Konfiguration:

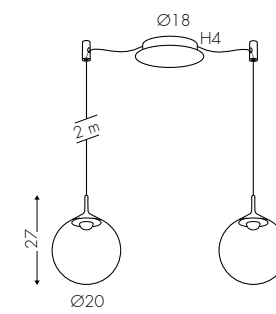

E2 Opale - Opal - Opal ● B 3000K



1073CTFNTE2B 2x6,5W 2x800lm* - 220V

590,00 €

Configura Configure / Konfigurieren

www.teamitaliailluminazione.it

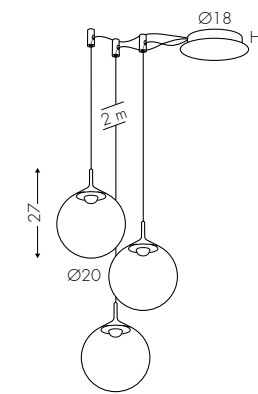

1073DTFNTE2B 3x6,5W 3x800lm - 220V

795,00 €

● C005T2NE Custom black cable

8,00 € /MT

Configura Configure / Konfigurieren

www.teamitaliailluminazione.it



● A 2700K



CODICE COMPLETO DEL PRODOTTO NELLA FOTO
FULL PRODUCT CODE AS SHOWN IN PICTURE - VOLLSTÄNDIGER CODE VOM ARTIKEL IM BILD

1073DTFNTE2B

Codice Code	Finitura Finishing Lackierung	Diffusore Diffuser Diffusor	Tonalità Hue Farbton
----------------	-------------------------------------	-----------------------------------	----------------------------

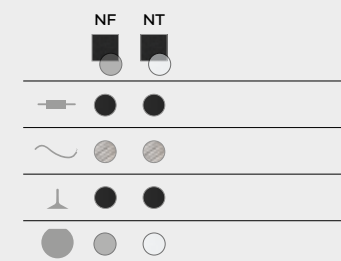

TF Taglio di Fase - Phase-Cut Dimmer - Phasenabschnittdimmer

A Alimentatore nel rosone - Power Supply inside the ceiling rose - Netzteil in der Deckendose

* 800lm effettivi - effective - effektive con - with - mit **E2**



LICIS

SOSPENSIONE (composizione)
SUSPENSION (composition)
SUSPENSION (composition)



configurazione standard: / basic configuration: / Standard Konfiguration:

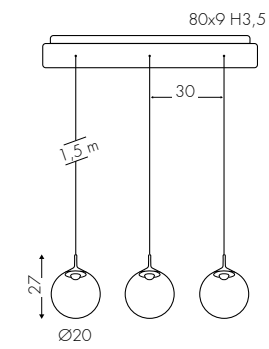

E2 Opale - Opal - Opal ● B 3000K



1073ETFNTE2B 3x6,5W 3x800lm* - 220V

990,00 €

Configura Configure / Konfigurieren

www.teamitaliailluminazione.it

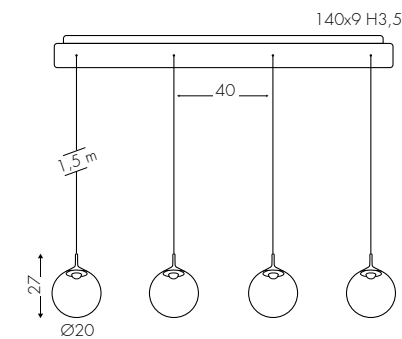

1073FTFNTE2B 4x6,5W 4x800lm - 220V

1.350,00 €

● **CO05T2NE** Custom black cable

8,00 € /MT

Configura Configure / Konfigurieren

www.teamitaliailluminazione.it



● A 2700K



CODICE COMPLETO DEL PRODOTTO NELLA FOTO
FULL PRODUCT CODE AS SHOWN IN PICTURE - VOLLSTÄNDIGER CODE VOM ARTIKEL IM BILD

1073ETFNTE2A

Codice Code	Finitura Finishing Lackierung	Diffusore Diffuser Diffusor	Tonalità Hue Farbton
----------------	-------------------------------------	-----------------------------------	----------------------------

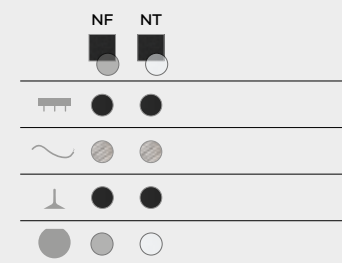

TF Taglio di Fase - Phase-Cut Dimmer - Phasenabschnittdimmer

A Alimentatore nel rosone - Power Supply inside the ceiling rose - Netzteil in der Deckendose

* 800lm effettivi - effective - effektive con - with - mit **E2**



LICIS

SOSPENSIONE (composizione)
SUSPENSION (composition)
SUSPENSION (composition)



configurazione standard: / basic configuration: / Standard Konfiguration:

E2 Opale - Opal - Opal ● B 3000K



1073GTFNTE2B 3x6,5W 3x800lm* - 220V

1.100,00 €

Configura Configure / Konfigurieren

www.teamitaliailluminazione.it

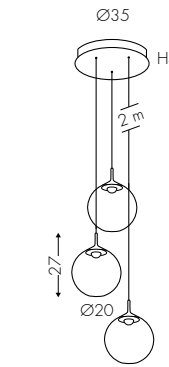

1073HTFNTE2B 6x6,5W 6x800lm - 220V

1.950,00 €

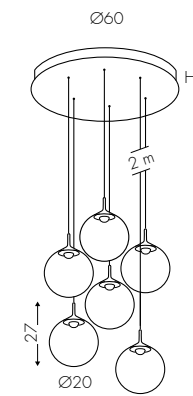

● C005T2NE Custom black cable

8,00 € /MT

Configura Configure / Konfigurieren

www.teamitaliailluminazione.it



● A 2700K



CODICE COMPLETO DEL PRODOTTO NELLA FOTO
FULL PRODUCT CODE AS SHOWN IN PICTURE · VOLLSTÄNDIGER CODE VOM ARTIKEL IM BILD

1073HTF **NT** **E2** **B**

Codice Code	Finitura Finishing Lackierung	Diffusore Diffuser Diffusor	Tonalità Hue Farbton
----------------	-------------------------------------	-----------------------------------	----------------------------

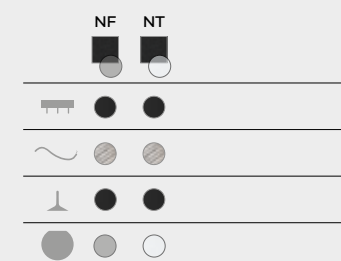

TF Taglio di Fase - Phase-Cut Dimmer - Phasenabschnittdimmer

A Alimentatore nel rosone - Power Supply inside the ceiling rose - Netzteil in der Deckendose

* 800lm effettivi - effective - effektive con - with - mit E2



configurazione standard: / basic configuration: / Standard Konfiguration:

E2 Opale - Opal

B 3000K

BV

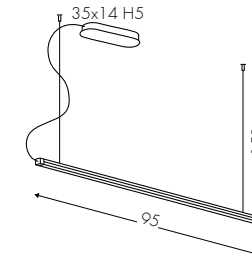

1016AOFBVE2B
1016ADMBVE2B

21W 1420lm* - 220V
DALI (Push) - 21W 1420lm - 220V

319,00 €
418,00 €

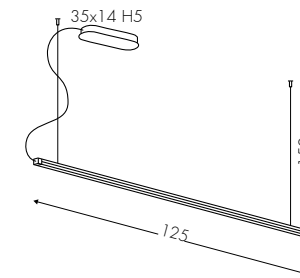

1016BOFBVE2B
1016BDMBVE2B

28W 1890lm - 220V
DALI (Push) - 28W 1890lm - 220V

342,00 €
442,00 €

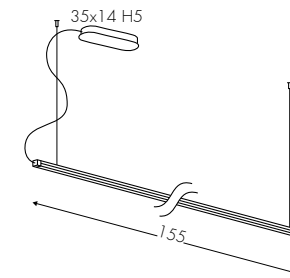

1016COFBVE2B
1016CDMBVE2B

35W 2350lm - 220V
DALI (Push) - 35W 2350lm - 220V

371,00 €
471,00 €

C005T2BV

Custom white cable

8,00 € /MT

C005T2RO

Custom red cable

8,00 € /MT

Configura

Configure / Konfigurieren

www.teamitaliailluminazione.it



A 2700K

BV



CODICE COMPLETO DEL PRODOTTO NELLA FOTO
FULL PRODUCT CODE AS SHOWN IN PICTURE - VOLLSTÄNDIGER CODE VOM ARTIKEL IM BILD

1016AOF

BV

E2

B

Codice
Code

Finitura
Finishing
Lackierung

Diffusore
Diffuser
Diffusor

Tonalità
Hue
Farbton

BV

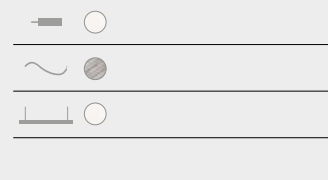

A Alimentatore nel rosone - Power Supply inside the ceiling rose - Netzteil in der Deckendose

* 1420lm effettivi - effective - effektive con - with - mit **E2**

LINEA DARK

SOSPENSIONE
SUSPENSION LAMP
PENDELLEUCHE



configurazione standard: / basic configuration: / Standard Konfiguration:

E19 UGR<19 Prism

B 3000K

BV

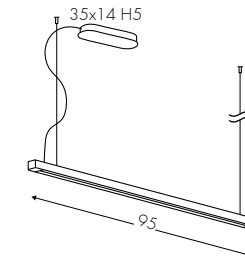

1021AOFBVE19B

21W 2200lm* + 5W 425lm - 220V

341,00 €

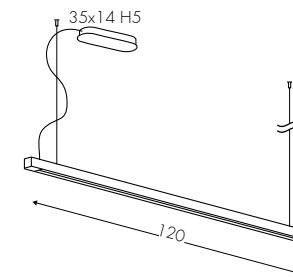

1021BOFBVE19B

27W 2320lm + 5W 425lm - 220V

364,00 €

1021BDMBVE19B

DALI (Push) - 27W 2320lm + 5W 425lm - 220V

467,00 €

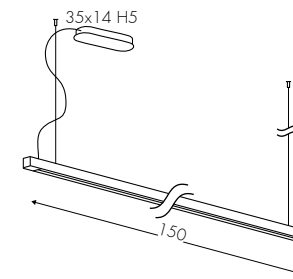

1021COFBVE19B

35W 2975lm + 5W 425lm - 220V

399,00 €

1021CDMBVE19B

DALI (Push) - 35W 2975lm + 5W 425lm - 220V

506,00 €

Configura

Configure / Konfigurieren

www.teamitaliailluminazione.it



A 2700K

NE RU



CODICE COMPLETO DEL PRODOTTO NELLA FOTO
FULL PRODUCT CODE AS SHOWN IN PICTURE - VOLLSTÄNDIGER CODE VOM ARTIKEL IM BILD

1021BOF **NE** **E19** **B**

Codice
Code

Finitura
Finishing
Lackierung

Diffusore
Diffuser
Diffusor

Tonalità
Hue
Farbton

BV NE RU

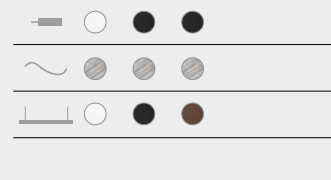

A Alimentatore nel rosone - Power Supply inside the ceiling rose - Netzteil in der Deckendose

* 2200lm effettivi - effective - effektive con - with - mit **E19**

INDEX

SECTION

FAMILY 119

MELLOW

SOSPENSIONE (composizione)
SUSPENSION (composition)
SUSPENSION (composition)



configurazione standard: / basic configuration: / Standard Konfiguration:

E2 Opale - Opal - Opal ● B 3000K



1083ATFBVE2B 6,5W 900lm* - 220V

370,00 €

[Configura](#) Configure / Konfigurieren

www.teamitaliailluminazione.it

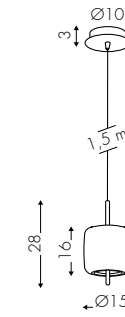

1083GTFBVE2B 3x6,5W 3x900lm - 220V

835,00 €

[Configura](#) Configure / Konfigurieren

www.teamitaliailluminazione.it

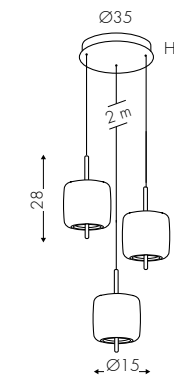

1083HTFBVE2B 6x6,5W 6x900lm - 220V

2.050,00 €

CO05T2NE Custom black cable

8,00 € /MT

[Configura](#) Configure / Konfigurieren

www.teamitaliailluminazione.it



● A 2700K

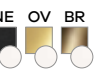

CODICE COMPLETO DEL PRODOTTO NELLA FOTO
FULL PRODUCT CODE AS SHOWN IN PICTURE - VOLLSTÄNDIGER CODE VOM ARTIKEL IM BILD

1083GTF OV E2 B

Codice Code	Finitura Finishing Lackierung	Diffusore Diffuser Diffusor	Tonalità Hue Farbton
----------------	-------------------------------------	-----------------------------------	----------------------------

	BV	NE	BR	OV
	<input type="radio"/>	<input type="radio"/>	<input type="radio"/>	<input type="radio"/>
	<input type="radio"/>	<input type="radio"/>	<input type="radio"/>	<input type="radio"/>
	<input type="radio"/>	<input type="radio"/>	<input type="radio"/>	<input type="radio"/>
	<input type="radio"/>	<input type="radio"/>	<input type="radio"/>	<input type="radio"/>

TF Taglio di Fase - Phase-Cut Dimmer - Phasenabschnittdimmer

A Alimentatore nel rosone - Power Supply inside the ceiling rose - Netzteil in der Deckendose

* 900lm effettivi - effective - effektive con - with - mit **E2**

MIRÓ HOME

UPLIGHT - DOWNLIGHT

SOSPENSIONE
SUSPENSION LAMP
PENDELLEUCHE



configurazione standard: / basic configuration: / Standard Konfiguration:

+ E2 Opale - Opal
24° Ottica - Optic - Optik

B 3000K

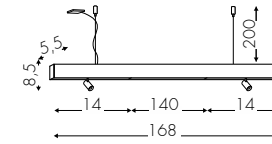

1030D11OFBVE2B

Spot 2x7W 2x680lm
44W 3761lm* + 18W 2390lm - 220V

829,00 €

1030D11DMBVE2B

DALI (Push) - Spot 2x7W 2x680lm
44W 3761lm + 18W 2390lm - 220V

1.146,00 €

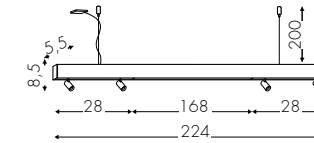

1030F22OFBVE2B

Spot 4x7W 4x680lm
53W 4513lm + 18W 2390lm - 220V

1.135,00 €

1030F22DMBVE2B

DALI (Push) - Spot 4x7W 4x680lm
53W 4513lm + 18W 2390lm - 220V

1.491,00 €

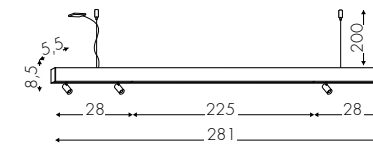

1030H22OFBVE2B

Spot 4x7W 4x680lm
70W 6020lm + 18W 2390lm - 220V

1.548,00 €

1030H22DMBVE2B

DALI (Push) - Spot 4x7W 4x680lm
70W 6020lm + 18W 2390lm - 220V

1.914,00 €

Configura



Configure / Konfigurieren

www.teamitaliailluminazione.it



CODICE COMPLETO DEL PRODOTTO NELLA FOTO
FULL PRODUCT CODE AS SHOWN IN PICTURE - VOLLSTÄNDIGER CODE VOM ARTIKEL IM BILD

1030D11OF **NE** **E2** **B**

Codice
Code

Finitura
Finishing
Lackierung

Diffusore
Diffuser
Diffusor

Tonalità
Hue
Farbton

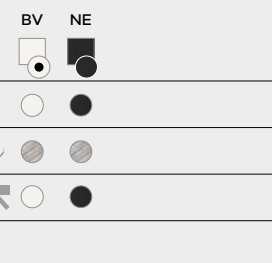

A Alimentatore Incorporato - Incorporated Power Supply - Eingebautes Netzteil

*3761lm effettivi - effective - effektive con - with - mit E2

INDEX

SECTION

FAMILY 123



BF custom finish

configurazione standard: / basic configuration: / Standard Konfiguration:

E2 Opale - Opal - Opal ● B 3000K



1082ATFBVE2B 6,5W 680lm* - 220V

310,00 €

[Configura](#) Configure / Konfigurieren

www.teamitaliailluminazione.it

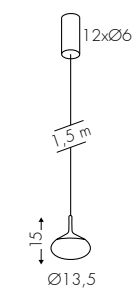

1082GTFBVE2B 4x6,5W 4x680lm - 220V

980,00 €

[Configura](#) Configure / Konfigurieren

www.teamitaliailluminazione.it

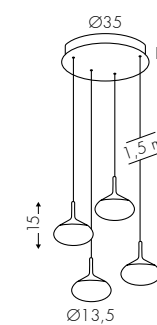

1082HTFBVE2B 6x6,5W 6x800lm - 220V

1.750,00 €

CO05T2NE Custom black cable

8,00 € /MT

[Configura](#) Configure / Konfigurieren

www.teamitaliailluminazione.it



● A 2700K



CODICE COMPLETO DEL PRODOTTO NELLA FOTO
FULL PRODUCT CODE AS SHOWN IN PICTURE - VOLLSTÄNDIGER CODE VOM ARTIKEL IM BILD

1082HTFB E2 A

Codice Code	Finitura Finishing Lackierung	Diffusore Diffuser Diffusor	Tonalità Hue Farbton
----------------	-------------------------------------	-----------------------------------	----------------------------

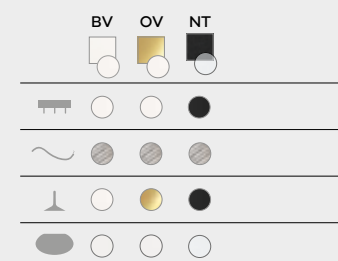

TF Taglio di Fase - Phase-Cut Dimmer - Phasenabschnittdimmer

A Alimentatore nel rosone - Power Supply inside the ceiling rose - Netzteil in der Deckendose

* 680lm effettivi - effective - effektive con - with - mit **E2**



configurazione standard: / basic configuration: / Standard Konfiguration:

E28 Satinato
Frosted - Satiniert BV

B 3000K

1009ATFBVE28B 13W 1000lm* - 220V 174,00 €

Configura Configure / Konfigurieren

www.teamitaliailluminazione.it

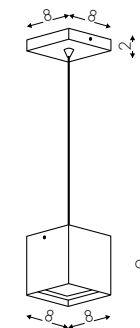

1009BTFBVE28B 26W 2000lm - 220V 325,00 €

Configura Configure / Konfigurieren

www.teamitaliailluminazione.it



CODICE COMPLETO DEL PRODOTTO NELLA FOTO
FULL PRODUCT CODE AS SHOWN IN PICTURE - VOLLSTÄNDIGER CODE VOM ARTIKEL IM BILD

1009ATF **NE** **E28** **B**

Codice Code	Finitura Finishing Lackierung	Diffusore Diffuser Diffusor	Tonalità Hue Farbton
----------------	-------------------------------------	-----------------------------------	----------------------------

BV	NE	RU
<input type="checkbox"/>	<input checked="" type="checkbox"/>	<input type="checkbox"/>
<input type="checkbox"/>	<input type="checkbox"/>	<input type="checkbox"/>
<input type="checkbox"/>	<input type="checkbox"/>	<input type="checkbox"/>
<input type="checkbox"/>	<input type="checkbox"/>	<input type="checkbox"/>

TF Taglio di Fase - Phase-Cut Dimmer - Phasenabschnittdimmer
A Alimentatore Incorporato - Incorporated Power Supply - Eingebautes Netzteil

* 1000lm effettivi - effective - effektive con - with - mit **E28**



configurazione standard: / basic configuration: / Standard Konfiguration:

E2 Opale - Opal - Opal B 3000K

BV

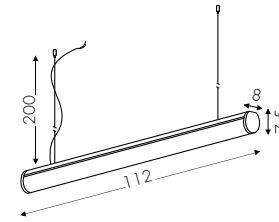

1065BBVE2B

25W 2856lm* - 24VDC

242,00 €

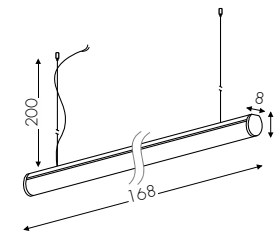

1065DBVE2B

37W 4290lm - 24VDC

276,00 €

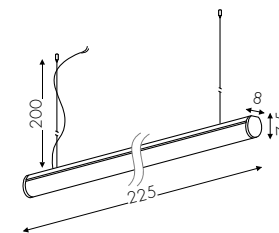

1065FBVE2B

50W 5738lm - 24VDC

321,00 €

Configura 

Configure / Konfigurieren

www.teamitaliailluminazione.it 



A 2700K C 4000K

NE

 CODICE COMPLETO DEL PRODOTTO NELLA FOTO
FULL PRODUCT CODE AS SHOWN IN PICTURE - VOLLSTÄNDIGER CODE VOM ARTIKEL IM BILD

1065D

Codice
Code

NE

Finitura
Finishing
Lackierung

E2

Diffusore
Diffuser
Diffusor

B

Tonalità
Hue
Farbton

BV

NE

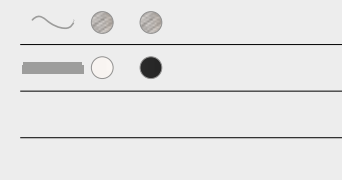

 Alimentatore 24VDC non incluso - Not Included 24VDC Driver
24VDC Netzteil nicht im Lieferumfang enthalten

Alimentatori a pag.132 - Power Supply p.132 - Netzteil p.132

* 2856lm effettivi - effective - effektive con - with - mit E2



configurazione standard: / basic configuration: / Standard Konfiguration:

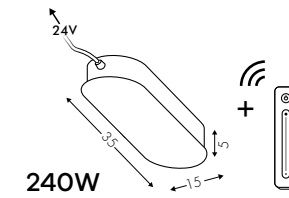
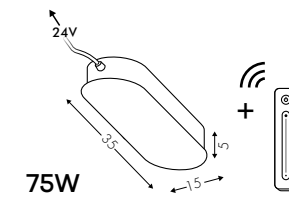

9065TWASDBV

75W - 220V (24VDC) + SMART DIM Tunable White

212,00 €

9065TWCSDBV

240W - 220V (24VDC) + SMART DIM Tunable White

307,00 €

Configura Configure / Konfigurieren

www.teamitaliailluminazione.it



BV

NE

configurazione standard: / basic configuration: / Standard Konfiguration:

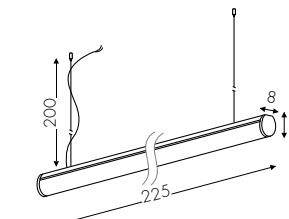
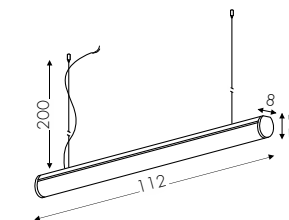

E2 Opale - Opal - Opal

D 2700/6500K

BV

1065TWBBVE2D

32W 3600lm* - 24VDC

279,00 €

1065TWFBVE2D

60W 6750lm - 24VDC

370,00 €

Configura Configure / Konfigurieren

www.teamitaliailluminazione.it



NE

6500K

2700K

CODICE COMPLETO DEL PRODOTTO NELLA FOTO
FULL PRODUCT CODE AS SHOWN IN PICTURE - VOLLSTÄNDIGER CODE VOM ARTIKEL IM BILD

1065TWB **BV** **E2** **D**

Codice
Code

Finitura
Finishing
Lackierung

Diffusore
Diffuser
Diffusor

Tonalità
Hue
Farbton

BV

NE

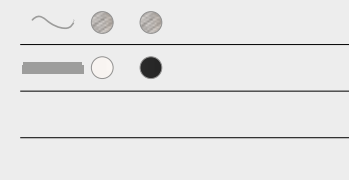

Alimentatore 24VDC non incluso - Not Included 24VDC Driver
24VDC Netzteil nicht im Lieferumfang enthalten

Alimentatori a pag.132 - Drivers p.132 - Netzteil p.132

Alimentatore Incorporato - Incorporated Power Supply - Eingebautes Netzteil

* 3600lm effettivi - effective - effektive con - with - mit **E2**

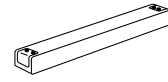

24V ON/OFF

AE003A	Driver 30W - On/Off 24V / IP20	29,00 €
AE003B	Driver 75W - On/Off 24V / IP20	45,00 €
AE003C	Driver 100W - On/Off 24V / IP65	74,00 €
AE003D	Driver 150W - On/Off 24V / IP65	98,00 €
AE003E	Driver 240W - On/Off 24V / IP65	127,00 €

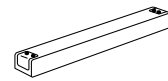

24V DALI

AE004A	Driver 150W - DALI (No-Push) 24V / IP65	113,00 €
---------------	---	-----------------

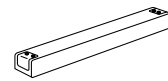

24V TRIAC

AE005A	Driver 100W - Triac 24V / IP20	124,00 €
AE005B	Driver 200W - Triac 24V / IP65	198,00 €

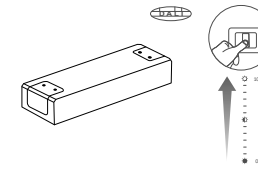

90106002

Dimmer: DALI(Push)/1-10V - max 240W-24VDC

79,00 €



9010SMARTCW

Dispositivo per la gestione di sorgenti led a luce calda/fredda con Radiocomando.
Twin-white Led light remote control.
Gerät für die Verwaltung von Led Quellen zum warm bis kalt Licht mit Fernsteuerung.

86,00 €



9010SMARTMD

Dispositivo per la gestione di sorgenti led a luce monocromatica con Radiocomando.
Monochromatic light management with remote control.
Gerät zur Verwaltung von monochromen LED-Lichtquellen mit Funkfernsteuerung.

74,00 €

BV NE

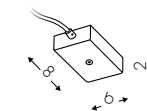

AM002A

Rosone (Solo collegamento elettrico rettangolo)
Canopy (Only electrical connection rectangle)
Xxx (Nur elektrische Verbindung Rechteck)

28,00 €

Configura

Configure / Konfigurieren

www.teamitaliailluminazione.it



CODICE COMPLETO • COMPLETE CODE • KOMPLETT CODE

AE003C

Codice
Code

CODICE COMPLETO • COMPLETE CODE • KOMPLETT CODE

90106002

Codice
Code

OVERLAP 2.0

SOSPENSIONE
SUSPENSION LAMP
PENDELLEUCHE



configurazione standard: / basic configuration: / Standard Konfiguration:

E2 Opale - Opal

● B 3000K

BV

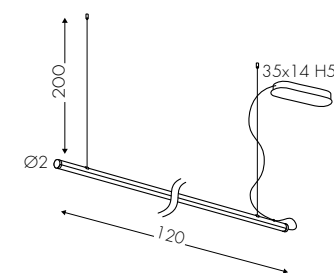

1015COFBVE2B
1015CDMBVE2B

28W 1890lm* - 220V
DALI (Push) - 28W 1890lm - 220V

363,00 €
435,00 €

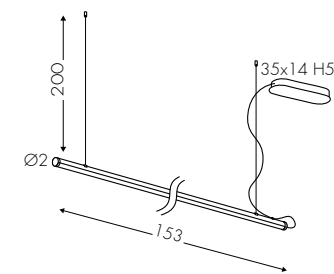

1015DOFBVE2B
1015DDMBVE2B

35W 2350lm - 220V
DALI (Push) - 35W 2350lm - 220V

397,00 €
470,00 €

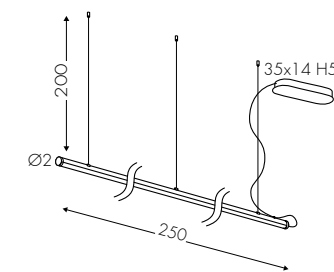

1015EOFBE2B
1015EDMBVE2B

55W 3800lm - 220V
DALI (Push) - 55W 3800lm - 220V

492,00 €
560,00 €

● C005T2NE

Custom black cable

8,00 € /MT

Configura

Configure / Konfigurieren

www.teamitaliailluminazione.it



● A 2700K



CODICE COMPLETO DEL PRODOTTO NELLA FOTO
FULL PRODUCT CODE AS SHOWN IN PICTURE - VOLLSTÄNDIGER CODE VOM ARTIKEL IM BILD

1015DOF **RV** **E2** **B**

Codice
Code

Finitura
Finishing
Lackierung

Diffusore
Diffuser
Diffusor

Tonalità
Hue
Farbton



A Alimentatore nel rosone - Power Supply inside the ceiling rose - Netzteil in der Deckendose

* 1890lm effettivi - effective - effektive con - with - mit **E2**

INDEX

SECTION

FAMILY 135

OVERLAP DECÒ

SOSPENSIONE
SUSPENSION LAMP
PENDELLEUCHE



configurazione standard: / basic configuration: / Standard Konfiguration:

E2 Opale - Opal

B 3000K

BV

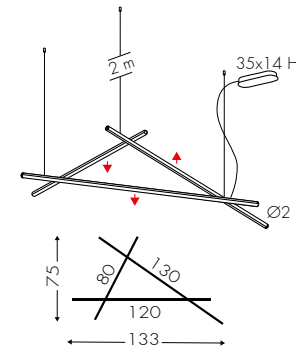

1015GTFBVE2B

75W 5500lm* - 220V

780,00 €

1015GDMBVE2B

DALI (Push) - 75W 5500lm - 220V

860,00 €

1015GSDBVE2B

75W 5500lm - 220V

860,00 €

Configura

Configure / Konfigurieren

www.teamitaliailluminazione.it

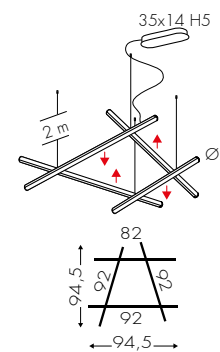

1015LTFBVE2B

78W 6000lm - 220V

780,00 €

1015LDMBVE2B

DALI (Push) - 78W 6000lm - 220V

860,00 €

1015LSDBVE2B

78W 6000lm - 220V

860,00 €

Configura

Configure / Konfigurieren

www.teamitaliailluminazione.it

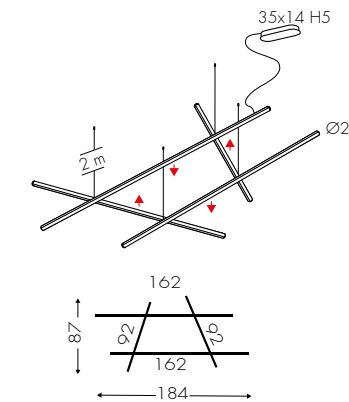

1015MTFBVE2B

110W 8500lm - 220V

890,00 €

1015MDMBVE2B

DALI (Push) - 110W 8500lm - 220V

970,00 €

1015MSDBVE2B

110W 8500lm - 220V

970,00 €

C005T2NE

Custom black cable

8,00 € /MT

Configura

Configure / Konfigurieren

www.teamitaliailluminazione.it



A

A 2700K



CODICE COMPLETO DEL PRODOTTO NELLA FOTO
FULL PRODUCT CODE AS SHOWN IN PICTURE - VOLLSTÄNDIGER CODE VOM ARTIKEL IM BILD

1015MTF **OV** **E2** **B**

Codice Code	Finitura Finishing Lackierung	Diffusore Diffuser Diffusor	Tonalità Hue Farbton
----------------	-------------------------------------	-----------------------------------	----------------------------

BV NE RU OV BR RV

A Alimentatore nel rosone - Power Supply inside the ceiling rose - Netzteil in der Deckendose

TF Taglio di Fase - Phase-Cut Dimmer - Phasenabschrittdimmer

SD Telecomando radio - Smart Dimmer - Smart Dimmer

* 5500lm effettivi - effective - effektiven con - with - mit E2



PLENI

SOSPENSIONE
SUSPENSION LAMP
PENDELLEUCHTE



configurazione standard: / basic configuration: / Standard Konfiguration:

E2 Opale - Opal

B 3000K

BV

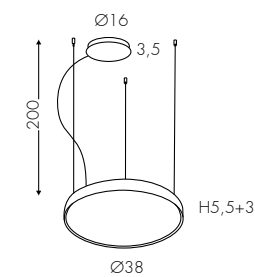

1067BOFBVE2B
1067BDMBVE2B

26W 3586lm* - 220V
DALI (Push) - 26W 3586lm - 220V

490,00 €
610,00 €

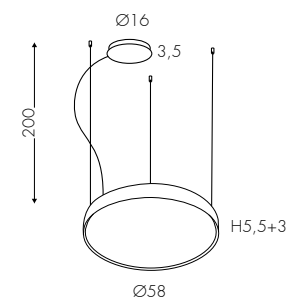

1067DOFBVE2B
1067DDMBVE2B

47W 6500lm - 220V
DALI (Push) - 47W 6500lm - 220V

675,00 €
775,00 €

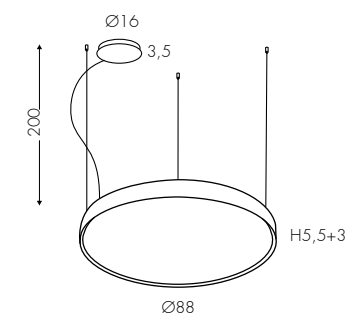

1067FOFBVE2B
1067FDMBVE2B

70W 8220lm - 220V
DALI (Push) - 70W 8220lm - 220V

970,00 €
1.070,00 €

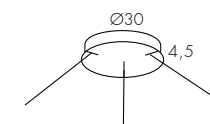

VAO03E

Variatione: sostituzione con rosone centrale Ø30cm
Variation: substitution with central ceiling rose Ø30cm
Variante: Ersatz durch zentrale Deckenrose Ø30cm

100,00 €

Configura

Configure / Konfigurieren

www.teamitaliailluminazione.it

C 4000K

E19 UGR<19 Prism

C 4000K

NE

CODICE COMPLETO DEL PRODOTTO NELLA FOTO
FULL PRODUCT CODE AS SHOWN IN PICTURE - VOLLSTÄNDIGER CODE VOM ARTIKEL IM BILD

1067DOF **NE** **E2** **B**

Codice Code
Finitura Finishing
Lackierung
Diffusore Diffuser
Diffusor
Tonalità Hue
Farbton

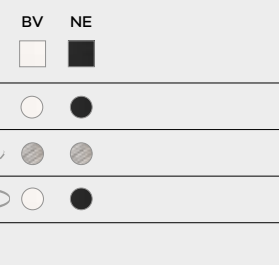

Alimentatore Incorporato - Incorporated Power Supply - Eingebautes Netzteil

* 3586lm effettivi - effective - effektive con - with - mit **E2**
4220lm effettivi - effective - effektive con - with - mit **E19** **+17,5%**

INDEX

SECTION

FAMILY 139

RIFLESSA

SOSPENSIONE
SUSPENSION LAMP
PENDELLEUCHE



configurazione standard: / basic configuration: / Standard Konfiguration:

E28 Satinato
Frosted - Satinert

B 3000K

BV

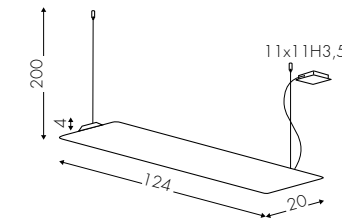

1052BOFBVE28B

36W 4050lm* - 220V

577,00 €

1052BDMBVE28B

DALI (Push) - 36W 4050lm - 220V

647,00 €

1052BTBVE28B

Bluetooth - 36W 4050lm - 220V

775,00 €

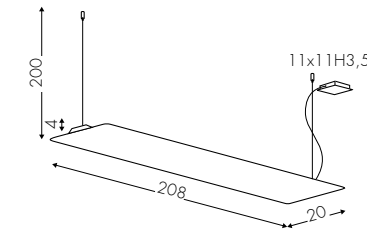

1052EOFVE28B

63W 7050lm - 220V

675,00 €

1052EDMBVE28B

DALI (Push) - 63W 7050lm - 220V

753,00 €

1052EBTVE28B

Bluetooth - 63W 7050lm - 220V

881,00 €

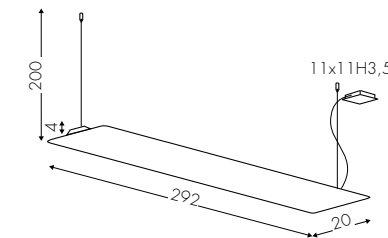

1052HOFVE28B

90W 10100lm - 220V

876,00 €

1052HDMBVE28B

DALI (Push) - 90W 10100lm - 220V

982,00 €

1052HBTVE28B

Bluetooth - 90W 10100lm - 220V

1.109,00 €

Configura

Configure / Konfigurieren

www.teamitaliailluminazione.it



A 2700K



BV NE RU OV BR RV

BT Bluetooth - Bluetooth - Bluetooth

A Alimentatore Incorporato - Incorporated Power Supply - Eingebautes Netzteil

* 4050lm effettivi - effective - effektive con - with - mit **E28**



RIFLESSA UPLIGHT + DARKLIGHT

SOSPENSIONE
SUSPENSION LAMP
PENDELLEUCHE



configurazione standard: / basic configuration: / Standard Konfiguration:

E28 Satinato - Frosted - Satinert
55° Ottica - Optic - Optik

B 3000K

BV

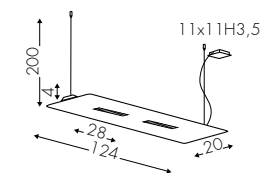

1053BOFBV55B
1053BDMBV55B
1053BBTBV55B

up 36W 4050lm* + down 15W 2000lm - 220V
DALI (Push) - up 36W 4050lm + down 15W 2000lm - 220V
Bluetooth - up 36W 4050lm + down 15W 2000lm - 220V

682,00 €
814,00 €
948,00 €

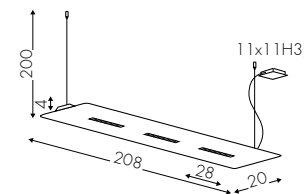

1053EOFBV55B
1053EDMBV55B
1053EBTBV55B

up 63W 7050lm + down 22W 3000lm - 220V
DALI (Push) - up 63W 7050lm + down 22W 3000lm - 220V
Bluetooth - up 63W 7050lm + down 22W 3000lm - 220V

877,00 €
970,00 €
1.104,00 €

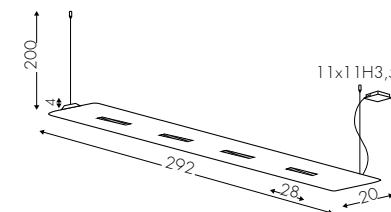

1053HOFBV55B
1053HDMBV55B
1053HBTBV55B

up 90W 10100lm + down 30W 4000lm - 220V
DALI (Push) - up 90W 10100lm + down 30W 4000lm - 220V
Bluetooth - up 90W 10100lm + down 30W 4000lm - 220V

1.158,00 €
1.337,00 €
1.471,00 €

Configura Configure / Konfigurieren

www.teamitaliailluminazione.it



A 2700K



CODICE COMPLETO DEL PRODOTTO NELLA FOTO
FULL PRODUCT CODE AS SHOWN IN PICTURE - VOLLSTÄNDIGER CODE VOM ARTIKEL IM BILD

1053EOF **BR** **55** **A**

Codice Code
Finitura Finishing
Diffusore Diffuser
Tonalità Hue

Lackierung
Diffusor
Farbton

BV NE RU OV BR RV

BT Bluetooth - Bluetooth - Bluetooth
A Alimentatore Incorporato - Incorporated Power Supply - Eingebautes Netzteil

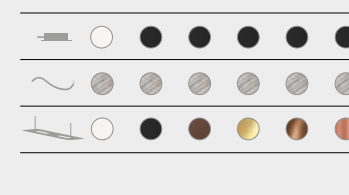

* 4050lm effettivi - effective - effektive con - with - mit **E28**

INDEX

SECTION

FAMILY 143

RIFLESSA

SOSPENSIONE
SUSPENSION LAMP
PENDELLEUCHE



configurazione standard: / basic configuration: / Standard Konfiguration:

E28 Satinato - Frosted - Satinert
24° Ottica - Optic - Optik

B 3000K

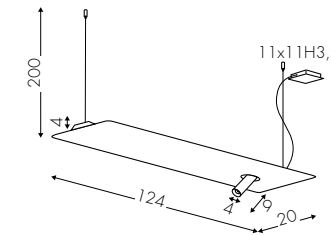

1054BOFBV24B
1054BDMBV24B
1054BBTBV24B

36W 4050lm* + 1x7W 1x680lm - 220V
DALI (Push) - 36W 4050lm + 1x7W 1x680lm - 220V
Bluetooth - 36W 4050lm + 1x7W 1x680lm - 220V

701,00 €
797,00 €
923,00 €

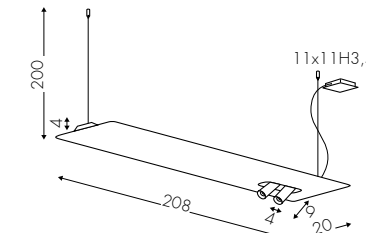

1054EOFBV24B
1054EDMBV24B
1054EBTBV24B

63W 7050lm + 2x7W 2x680lm - 220V
DALI (Push) - 63W 7050lm + 2x7W 2x680lm - 220V
Bluetooth - 63W 7050lm + 2x7W 2x680lm - 220V

804,00 €
934,00 €
1.061,00 €

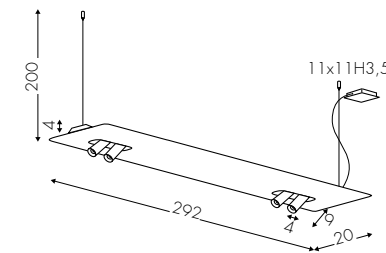

1054HOFBV24B
1054HDMBV24B
1054HBTBV24B

90W 10100lm + 4x7W 4x680lm - 220V
DALI (Push) - 90W 10100lm + 4x7W 4x680lm - 220V
Bluetooth - 90W 10100lm + 4x7W 4x680lm - 220V

1.236,00 €
1.348,00 €
1.475,00 €

Configura

Configure / Konfigurieren

www.teamitaliailluminazione.it



A 2700K



CODICE COMPLETO DEL PRODOTTO NELLA FOTO
FULL PRODUCT CODE AS SHOWN IN PICTURE - VOLLSTÄNDIGER CODE VOM ARTIKEL IM BILD

1054EOF **ON** **24** **A**

Codice Code
Finitura Finishing Lackierung
Diffusore Diffuser Diffusor
Tonalità Hue Farbton

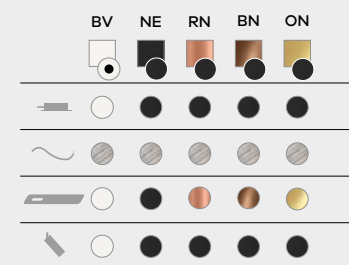

BT Bluetooth - Bluetooth - Bluetooth
A Alimentatore Incorporato - Incorporated Power Supply - Eingebautes Netzteil

* 4050lm effettivi - effective - effektive con - with - mit **E28**



SAMPLING VENIS/LAMBDA/LICIS

SOSPENSIONE (composizione)
SUSPENSION (composition)
SUSPENSION (composition)



configurazione standard: / basic configuration: / Standard Konfiguration:

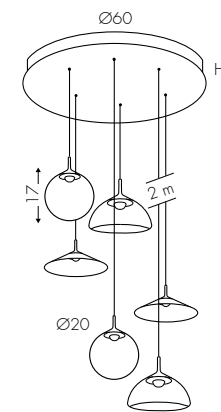

E19 Prismatico - Prism
E2 Opale - Opal - Opal

B 3000K

A1

1080ATFA1B

6x6,5W 6x800lm - 220V

1.850,00 €

2X



ON Oro + Nero
Gold + Black
Gold + Schwarz
E19 Prismatico - Prism



2X



NF Nero + vetro fumè
Black + fumè glass
Schwarz + Rauchglaselement
E2 Opale - Opal - Opal



2X



NZ Nero + vetro bronzo
Black + bronze glass
Schwarz + Bronze Glas.
E2 Opale - Opal - Opal



CO05T2NE

Custom black cable

8,00 € /MT

Configura



Configure / Konfigurieren

www.teamitaliailluminazione.it



A

A 2700K

CODICE COMPLETO DEL PRODOTTO NELLA FOTO
FULL PRODUCT CODE AS SHOWN IN PICTURE - VOLLSTÄNDIGER CODE VOM ARTIKEL IM BILD

1080ATF **A1** **A**

Codice
Code

Finitura
Finishing
Lackierung

Tonalità
Hue
Farbton

SHADOW

SOSPENSIONE
SUSPENSION LAMP
PENDELLEUCHE



configurazione standard: / basic configuration: / Standard Konfiguration:

E2 Opale - Opal - Opal ● B 3000K

BV

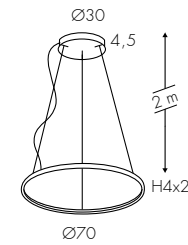

1068BTFBVE2B 49W 3440lm* - 220V € 595,00
1068BDMBVE2B DALI (Push) - 49W 3340lm - 220V € 670,00

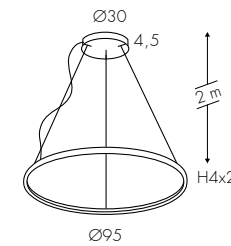

1068CTFBVE2B 66W 5630lm - 220V € 695,00
1068CDMBVE2B DALI (Push) - 66W 5630lm - 220V € 788,00

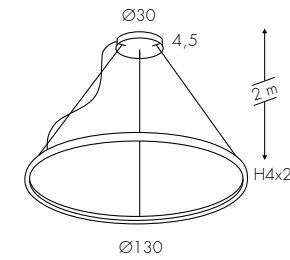

1068DTFBVE2B 90W 11860lm - 220V € 835,00
1068DDMBVE2B DALI (Push) - 90W 11860lm - 220V € 935,00



VA004A € 88,00
 Variazione: sostituzione con rosone decentrato
 Variation: substitution with decentralized ceiling rose
 Variante: ersatz durch dezentral deckenrose

CO05T2NE Custom black cable € 8,00 /MT

Configura Configure / Konfigurieren

www.teamitaliailluminazione.it



● A 2700K



BV NE RV BR OV

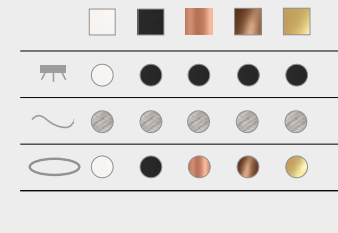

A Alimentatore nel rosone - Power Supply inside the ceiling rose - Netzteil in der Deckendose
TF Taglio di Fase - Phase-Cut Dimmer - Phasenabschrittdimmer

* 3440lm effettivi - effective - effektiven con - with - mit **E2**



CODICE COMPLETO DEL PRODOTTO NELLA FOTO
 FULL PRODUCT CODE AS SHOWN IN PICTURE - VOLLSTÄNDIGER CODE VOM ARTIKEL IM BILD

1068CTF **RV** **E2** **B**

Codice Code Finitura Finishing Diffusore Diffuser Tonalità Hue
 Code Code Lackierung Diffusor Farbton

SHADOW

SOSPENSIONE (composizione)
SUSPENSION (composition)
SUSPENSION (composition)



configurazione standard: / basic configuration: / Standard Konfiguration:

E2 Opale - Opal - Opal ● B 3000K

BV

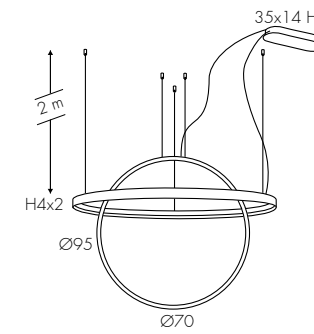

1068CHTFBVE2B
1068CHDMBVE2B

66W 5630lm* + 49W 3440lm 220V
DALI (Push) - 66W 5630lm + 49W 3440lm 220V

1.200,00 €
1.370,00 €

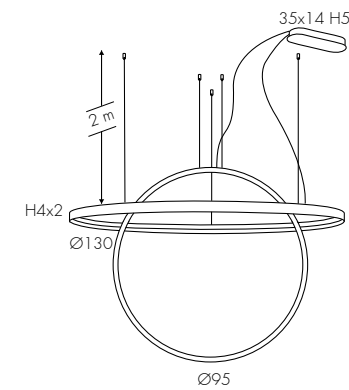

1068DITFBVE2B
1068DIDMBVE2B

90W 7750lm + 66W 3680lm 220V
DALI (Push) - 90W 7750lm + 66W 3680lm 220V

1.442,00 €
1.635,00 €

● C005T2NE Custom black cable

8,00 € /MT

Configura Configure / Konfigurieren

www.teamitaliailluminazione.it



● A 2700K



CODICE COMPLETO DEL PRODOTTO NELLA FOTO
FULL PRODUCT CODE AS SHOWN IN PICTURE - VOLLSTÄNDIGER CODE VOM ARTIKEL IM BILD

1068DITF **OV** **E2** **B**

Codice Code	Finitura Finishing Lackierung	Diffusore Diffuser Diffusor	Tonalità Hue Farbton
----------------	-------------------------------------	-----------------------------------	----------------------------

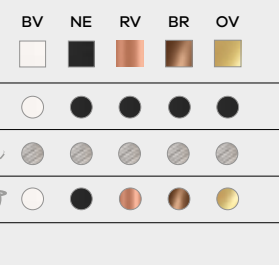

A Alimentatore nel rosone - Power Supply inside the ceiling rose - Netzteil in der Deckendose
TF Taglio di Fase - Phase-Cut Dimmer - Phasenabschrittdimmer

* 5630lm effettivi - effective - effektive con - with - mit **E2**

INDEX

SECTION

FAMILY 151



SHAPE

SOSPENSIONE
SUSPENSION LAMP
PENDELLEUCHE



configurazione standard: / basic configuration: / Standard Konfiguration:

E2 Opale - Opal ● B 3000K BV

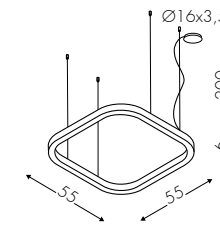

1031AOFBVE2B
1031ADMBVE2B

52W 4510lm* + 18W 2200lm - 220V
DALI (Push) - 52W 4510lm + 18W 2200lm - 220V

855,00 €
936,00 €

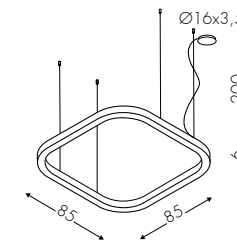

1031BOFBVE2B
1031BDMBVE2B

83W 6800lm + 20W 2300lm - 220V
DALI (Push) - 83W 6800lm + 20W 2300lm - 220V

1.493,00 €
1.604,00 €

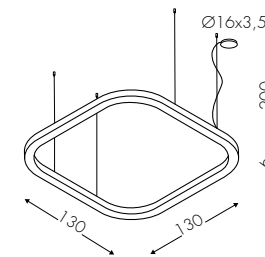

1031COFBVE2B
1031CDMBVE2B

114W 9270lm + 30W 3861lm - 220V
DALI (Push) - 114W 9270lm + 30W 3861lm - 220V

1.926,00 €
2.062,00 €

Configura Configure / Konfigurieren

www.teamitaliailluminazione.it



E19 UGR<19 Prism ● A 2700K ○ C 4000K

NE RU

CODICE COMPLETO DEL PRODOTTO NELLA FOTO
FULL PRODUCT CODE AS SHOWN IN PICTURE - VOLLSTÄNDIGER CODE VOM ARTIKEL IM BILD

1031BOF **NE** **E2** **B**

Codice Code	Finitura Finishing Lackierung	Diffusore Diffuser Diffusor	Tonalità Hue Farbton
----------------	-------------------------------------	-----------------------------------	----------------------------

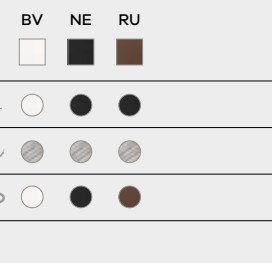

A Alimentatore Incorporato - Incorporated Power Supply - Eingebautes Netzteil

* 4510lm effettivi - effective - effektive con - with - mit **E2**
5300lm effettivi - effective - effektive con - with - mit **E19** ↻ +17,5%

INDEX

SECTION

FAMILY 153

SHAPE

SOSPENSIONE
SUSPENSION LAMP
PENDELLEUCHE



BR custom finish

configurazione standard: / basic configuration: / Standard Konfiguration:

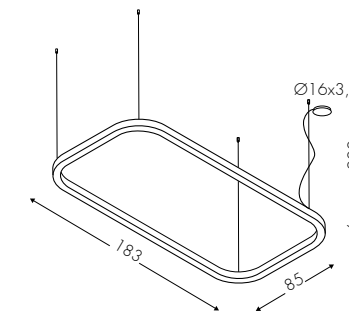

E2 Opale - Opal

B 3000K

BV



1031DOFBVE2B

105W 9780lm* + 25W 3100lm - 220V

2.026,00 €

1031DDMBVE2B

DALI (Push) 105W 9780lm + 25W 3100lm - 220V

2.206,00 €

Configura

Configure / Konfigurieren

www.teamitaliailluminazione.it



E19 UGR<19 Prism

A 2700K

C 4000K

NE RU



CODICE COMPLETO DEL PRODOTTO NELLA FOTO
FULL PRODUCT CODE AS SHOWN IN PICTURE - VOLLSTÄNDIGER CODE VOM ARTIKEL IM BILD

1031DOF

Codice
Code

BR

Finitura
Finishing
Lackierung

E2

Diffusore
Diffuser
Diffusor

C

Tonalità
Hue
Farbton

BV NE RU

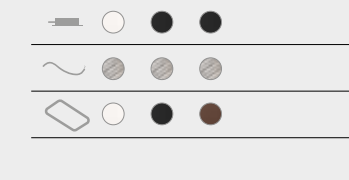

Alimentatore Incorporato - Incorporated Power Supply - Eingebautes Netzteil

* 9780lm effettivi - effective - effektive con - with - mit **E2**
11.500lm effettivi - effective - effektive con - with - mit **E19** **+17,5%**

INDEX

SECTION

FAMILY 155

S-POT

SOSPENSIONE
SUSPENSION LAMP
PENDELLEUCHTE



configurazione standard: / basic configuration: / Standard Konfiguration:

BV



GU10

1018COFBV

1x GU10 max 7W LED - 220V

75,00 €

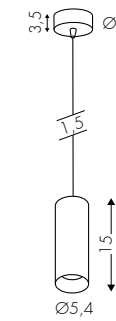

1018DOFBV

1x GU10 max 7W LED - 220V

91,00 €

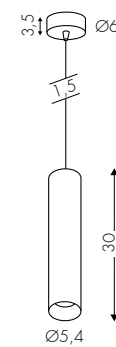

1018EOFBV

1x GU10 max 7W LED - 220V

117,00 €

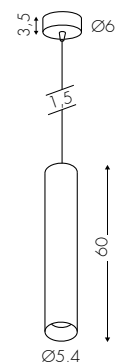

C005T2NE

Custom black cable

8,00 € /MT

Configura



Configure / Konfigurieren

www.teamitaliailluminazione.it



CODICE COMPLETO DEL PRODOTTO NELLA FOTO
FULL PRODUCT CODE AS SHOWN IN PICTURE - VOLLSTÄNDIGER CODE VOM ARTIKEL IM BILD

1018COF

Codice
Code

NE

Finitura
Finishing
Lackierung

BV NE RV BR OV

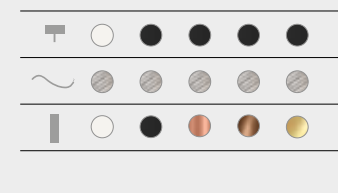

GU10 Sorgente GU10 non inclusa - GU10 light source not included - GU10 Lichtquelle nicht enthalten



INDEX



SECTION



FAMILY

157



S-POT

SOSPENSIONE
SUSPENSION LAMP
PENDELLEUCHE



configurazione standard: / basic configuration: / Standard Konfiguration:

E28 Satinato
Frosted - Satiniert BV

B 3000K

1018ATFBVE28B 17W 1500lm* - 220V 203,00 €

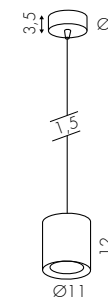

Configura Configure / Konfigurieren

www.teamitaliailluminazione.it



A 2700K C 4000K



configurazione standard: / basic configuration: / Standard Konfiguration:

24° Ottica - Optic - Optik BV

B 3000K

1018BOFBV24B 26W 3400lm - 220V 278,00 €

1018BDMBV24B DALI (Push) - 26W 3400lm - 220V 347,00 €

1018BTFBV24B 26W 3400lm - 220V 323,00 €

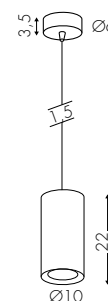

Configura Configure / Konfigurieren

www.teamitaliailluminazione.it



C 4000K



CODICE COMPLETO DEL PRODOTTO NELLA FOTO
FULL PRODUCT CODE AS SHOWN IN PICTURE - VOLLSTÄNDIGER CODE VOM ARTIKEL IM BILD

1018BOF **NE** **24** **B**

Codice
Code

Finitura
Finishing
Lackierung

Diffusore
Diffuser
Diffusor

Tonalità
Hue
Farbton

BV NE RU

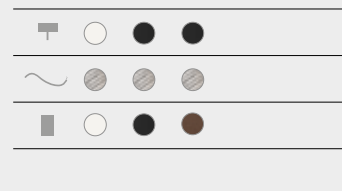

TF Taglio di Fase - Phase-Cut Dimmer - Erhältlich Phasenabschnittdimmer

A Alimentatore Incorporato - Incorporated Power Supply - Eingebautes Netzteil

* 1500lm effettivi - effective - effektive con - with - mit **E28**



TUBICO

SOSPENSIONE
SUSPENSION LAMP
PENDELLEUCHE



configurazione standard: / basic configuration: / Standard Konfiguration:

E8 Trasparente - Transparent ● B 3000K



1069IOFONE8B 3W 350lm* - 220V

234,00 €

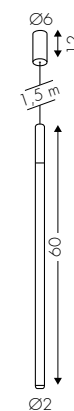

● C005T2NE Custom black cable

8,00 € /MT

Configura Configure / Konfigurieren

www.teamitaliailluminazione.it



A

E19

● A 2700K



CODICE COMPLETO DEL PRODOTTO NELLA FOTO
FULL PRODUCT CODE AS SHOWN IN PICTURE - VOLLSTÄNDIGER CODE VOM ARTIKEL IM BILD

1069IOF **ZN** **E8** **B**

Codice
Code

Finitura
Finishing
Lackierung

Diffusore
Diffuser
Diffusor

Tonalità
Hue
Farbton



standard

E8

	ON	ZN	PN	BF
	●	●	●	●
	●	●	●	●
	●	●	●	●
	●	●	●	●

A Alimentatore nel rosone - Power Supply inside the ceiling rose - Netzteil in der Deckendose

* 350lm effettivi - effective - effektive con - with - mit E8

INDEX

SECTION

FAMILY 161



TUBICO

SOSPENSIONE
SUSPENSION LAMP
PENDELLEUCHTE



configurazione standard: / basic configuration: / Standard Konfiguration:

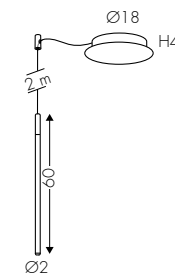

E8 Trasparente - Transparent ● **B** 3000K



1069OOFONE8B 3W 350lm* - 220V

248,00 €

[Configura](#) Configure / Konfigurieren

www.teamitaliailluminazione.it

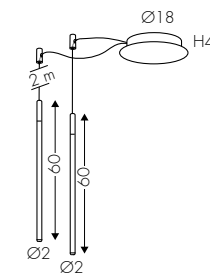

1069PTFONE8B 2x3W 2x350lm - 220V

454,00 €

[Configura](#) Configure / Konfigurieren

www.teamitaliailluminazione.it

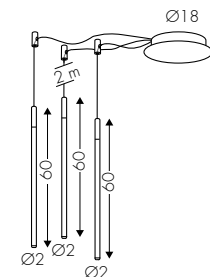

1069MTFONE8B 3x3W 3x350lm - 220V

660,00 €

CO05T2NE Custom black cable

8,00 € /MT

[Configura](#) Configure / Konfigurieren

www.teamitaliailluminazione.it



A

E19 ● **A** 2700K

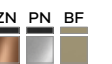

optional



CODICE COMPLETO DEL PRODOTTO NELLA FOTO
FULL PRODUCT CODE AS SHOWN IN PICTURE - VOLLSTÄNDIGER CODE VOM ARTIKEL IM BILD

1069MTF PN E8 B

Codice
Code

Finitura
Finishing
Lackierung

Diffusore
Diffuser
Diffusor

Tonalità
Hue
Farbton

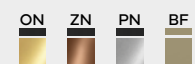

A Alimentatore nel rosone - Power Supply inside the ceiling rose - Netzteil in der Deckendose
TF Taglio di Fase - Phase-Cut Dimmer - Phasenabschrittdimmer

* 350lm effettivi - effective - effektive con - with - mit **E8**

INDEX

SECTION

FAMILY 163

TUBICO

SOSPENSIONE (composizione)
SUSPENSION (composition)
SUSPENSION (composition)

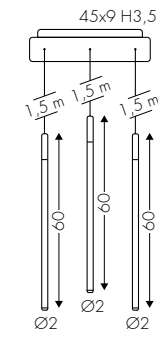

configurazione standard: / basic configuration: / Standard Konfiguration:

E8 Trasparente - Transparent ● **B** 3000K



1069LTFONE8B 3x3W 3x350lm* - 220V

765,00 €

[Configura](#) Configure / Konfigurieren

www.teamitaliailluminazione.it

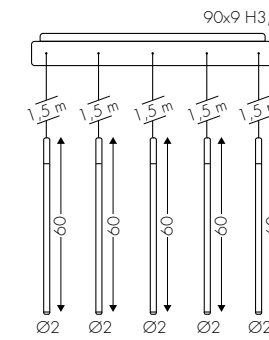

1069QTFONE8B 5x3W 5x350lm - 220V

1.155,00 €

[Configura](#) Configure / Konfigurieren

www.teamitaliailluminazione.it

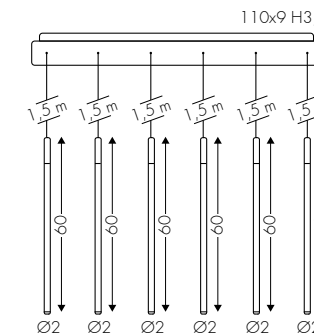

1069RTFONE8B 6x3W 6x350lm - 220V

1.382,00 €

CO05T2NE Custom black cable

8,00 € /MT

[Configura](#) Configure / Konfigurieren

www.teamitaliailluminazione.it



A

E19 ● **A** 2700K

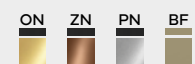
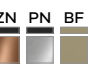

A Alimentatore nel rosone - Power Supply inside the ceiling rose - Netzteil in der Deckendose
TF Taglio di Fase - Phase-Cut Dimmer - Phasenabschrittdimmer

* 350lm effettivi - effective - effektive con - with - mit **E8**

CODICE COMPLETO DEL PRODOTTO NELLA FOTO
FULL PRODUCT CODE AS SHOWN IN PICTURE - VOLLSTÄNDIGER CODE VOM ARTIKEL IM BILD

1069LTF **ON** **E8** **A**

Codice Code	Finitura Finishing Lackierung	Diffusore Diffuser Diffusor	Tonalità Hue Farbton
----------------	-------------------------------------	-----------------------------------	----------------------------





custom mixed finish

configurazione standard: / basic configuration: / Standard Konfiguration:

E8 Trasparente - Transparent ● B 3000K



1069NTFONE8B 4x3W 4x350lm* - 220V

928,00 €

Configura Configure / Konfigurieren

www.teamitaliailluminazione.it

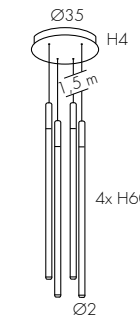

1069STFONE8B 6x3W 6x350lm - 220V

1.327,00 €

Configura Configure / Konfigurieren

www.teamitaliailluminazione.it

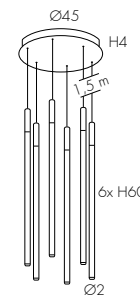

1069TTFONE8B 12x3W 12x350lm - 220V

2.844,00 €

CO05T2NE Custom black cable

8,00 € /MT

Configura Configure / Konfigurieren

www.teamitaliailluminazione.it



A E19 ● A 2700K

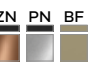

CODICE COMPLETO • COMPLETE CODE • VOLLSTÄNDIGE CODE

1069TTF **ON** **E8** **B**

Codice
Code

Finitura
Finishing
Lackierung

Diffusore
Diffuser
Diffusor

Tonalità
Hue
Farbton

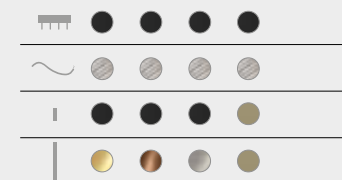
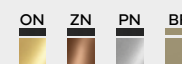

A Alimentatore nel rosone - Power Supply inside the ceiling rose - Netzteil in der Deckendose
TF Taglio di Fase - Phase-Cut Dimmer - Phasenabschrittdimmer

* 350lm effettivi - effective - effektive con - with - mit **E8**

standard



E8



VELATA

SOSPENSIONE
SUSPENSION LAMP
PENDELLEUCHE



configurazione standard: / basic configuration: / Standard Konfiguration:

E28 Satinato
Frosted - Satinert

● B 3000K

BV

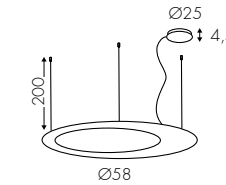

1038AOFBVE28B
1038ADMBVE28B
1038ATFBVE28B

25W 3700lm* - 220V
DALI (Push) - 25W 3700lm - 220V
25W 3700lm - 220V

648,00 €
790,00 €
790,00 €

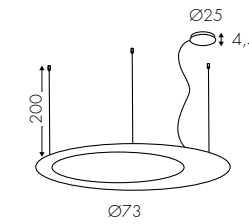

1038BOFBVE28B
1038BDMBVE28B
1038BTFBVE28B

50W 6400lm - 220V
DALI (Push) - 50W 6400lm - 220V
50W 6400lm - 220V

816,00 €
903,00 €
903,00 €

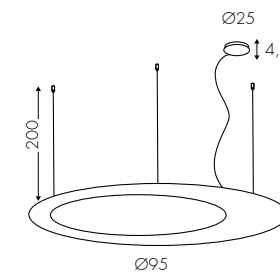

1038COFBVE28B
1038CDMBVE28B
1038CBTVE28B

75W 7800lm - 220V
DALI (Push) - 75W 7800lm - 220V
Bluetooth 75W 7800lm - 220V

1.047,00 €
1.164,00 €
1.164,00 €

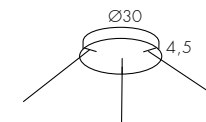

VA003E

Variatione: sostituzione con rosone centrale Ø30cm
Variation: substitution with central ceiling rose Ø30cm
Variante: Ersatz durch zentrale Deckenrose Ø30cm

100,00 €

Configura

Configure / Konfigurieren

www.teamitaliailluminazione.it



● A 2700K

NE RV BR OV

CODICE COMPLETO DEL PRODOTTO NELLA FOTO
FULL PRODUCT CODE AS SHOWN IN PICTURE - VOLLSTÄNDIGER CODE VOM ARTIKEL IM BILD

1038BOF **NE** **E28** **B**

Codice
Code

Finitura
Finishing
Lackierung

Diffusore
Diffuser
Diffusor

Tonalità
Hue
Farbton

BV NE RV BR OV

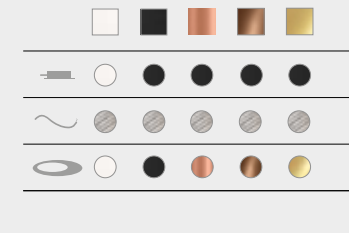

TF Taglio di Fase - Phase-Cut Dimmer - Phasenabschrittdimmer

A Alimentatore nel rosone - Power Supply inside the ceiling rose - Netzteil in der Deckendose

BT Bluetooth - Bluetooth - Bluetooth

* 3700lm effettivi - effective - effektive con - with - mit **E28**

INDEX

SECTION

FAMILY 169



VENIS

SOSPENSIONE
SUSPENSION LAMP
PENDELLEUCHE



configurazione standard: / basic configuration: / Standard Konfiguration:

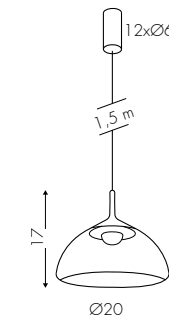

E2 Opale
Opal - Opal

B 3000K



1064ATFNTE2B

6,5W 800lm* - 220V

350,00 €

C005T2NE

Custom black cable

8,00 € /MT

Configura

Configure / Konfigurieren

www.teamitaliailluminazione.it



A

A 2700K



CODICE COMPLETO DEL PRODOTTO NELLA FOTO
FULL PRODUCT CODE AS SHOWN IN PICTURE - VOLLSTÄNDIGER CODE VOM ARTIKEL IM BILD

1064ATF **NT** **E2** **B** + **C005T2NE**

Codice
Code

Finitura
Finishing
Lackierung

Diffusore
Diffuser
Diffusor

Tonalità
Hue
Farbton

Codice
Code

custom BLACK CABLE

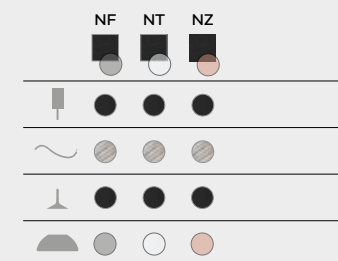

A Alimentatore nel rosone - Power Supply inside the ceiling rose - Netzteil in der Deckendose
TF Taglio di Fase - Phase-Cut Dimmer - Phasenabschrittdimmer

* 800lm effettivi - effective - effektive con - with - mit **E2**



VENIS

SOSPENSIONE (composizione)
SUSPENSION (composition)
SUSPENSION (composition)



configurazione standard: / basic configuration: / Standard Konfiguration:

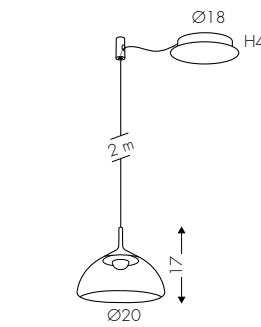

E2 Opale
Opal - Opal

B 3000K



1064BTFNTE2B 6,5W 800lm* - 220V

370,00 €

Configura Configure / Konfigurieren

www.teamitaliailluminazione.it

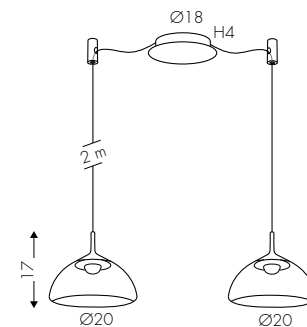

1064CTFNTE2B 2x6,5W 2x800lm - 220V

590,00 €

Configura Configure / Konfigurieren

www.teamitaliailluminazione.it

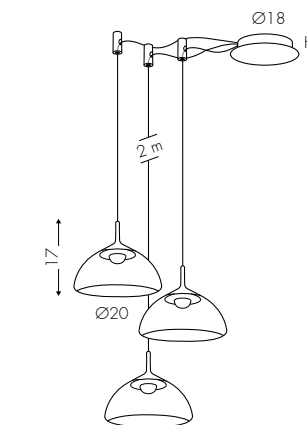

1064DTFNTE2B 3x6,5W 3x800lm - 220V

795,00 €

C005T2NE Custom black cable

8,00 € /MT

Configura Configure / Konfigurieren

www.teamitaliailluminazione.it



A 2700K



CODICE COMPLETO DEL PRODOTTO NELLA FOTO
FULL PRODUCT CODE AS SHOWN IN PICTURE - VOLLSTÄNDIGER CODE VOM ARTIKEL IM BILD

1064CTF **NT** **E2** **A**

Codice Code	Finitura Finishing Lackierung	Diffusore Diffuser Diffusor	Tonalità Hue Farbton
----------------	-------------------------------------	-----------------------------------	----------------------------

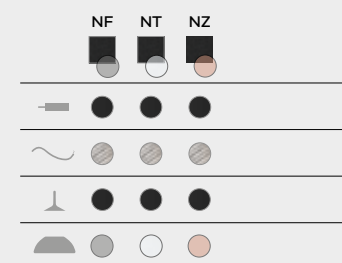

A Alimentatore nel rosone - Power Supply inside the ceiling rose - Netzteil in der Deckendose
TF Taglio di Fase - Phase-Cut Dimmer - Phasenabschrittdimmer

* 800lm effettivi - effective - effektiven con - with - mit **E2**

INDEX

SECTION

FAMILY 173



VENIS

SOSPENSIONE (composizione)
SUSPENSION (composition)
SUSPENSION (composition)



configurazione standard: / basic configuration: / Standard Konfiguration:

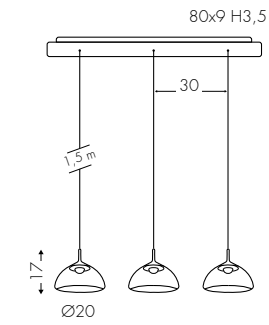

E2 Opale
Opal - Opal

B 3000K



1064TFNTE2B

3x6,5W 3x800lm* - 220V

990,00 €

Configura

Configure / Konfigurieren

www.teamitaliailluminazione.it

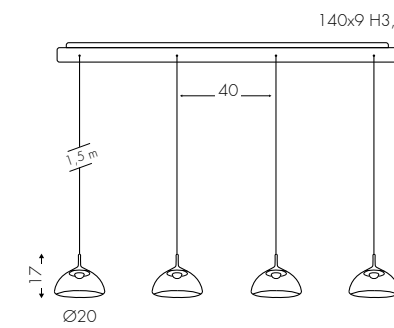

1064FTNTE2B

4x6,5W 4x800lm - 220V

1.350,00 €

CO05T2NE

Custom black cable

8,00 € /MT

Configura

Configure / Konfigurieren

www.teamitaliailluminazione.it



A 2700K



CODICE COMPLETO DEL PRODOTTO NELLA FOTO
FULL PRODUCT CODE AS SHOWN IN PICTURE - VOLLSTÄNDIGER CODE VOM ARTIKEL IM BILD

1064FTF **NZ** **E2** **A**

Codice Code	Finitura Finishing Lackierung	Diffusore Diffuser Diffusor	Tonalità Hue Farbton
----------------	-------------------------------------	-----------------------------------	----------------------------

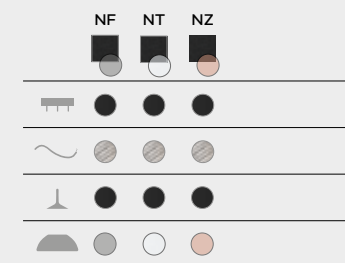

A Alimentatore nel rosone - Power Supply inside the ceiling rose - Netzteil in der Deckendose
TF Taglio di Fase - Phase-Cut Dimmer - Phasenabschrittdimmer

* 800lm effettivi - effective - effektiven con - with - mit **E2**



VENIS

SOSPENSIONE (composizione)
SUSPENSION (composition)
SUSPENSION (composition)



configurazione standard: / basic configuration: / Standard Konfiguration:

E2 Opale
Opal - Opal

B 3000K

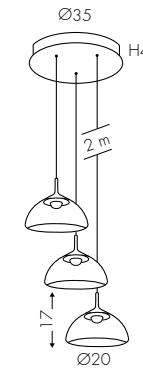

1064GTFNTE2B

3x6,5W 3x800lm* - 220V

1.100,00 €

Configura

Configure / Konfigurieren

www.teamitaliailluminazione.it

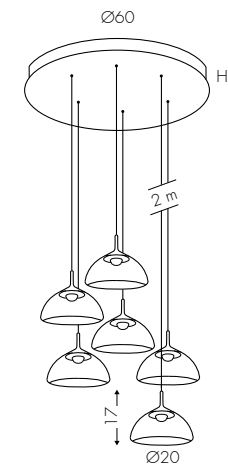

1064HTFNTE2B

6x6,5W 6x800lm - 220V

1.950,00 €

CO05T2NE

Custom black cable

8,00 € /MT

Configura

Configure / Konfigurieren

www.teamitaliailluminazione.it



A

A 2700K



CODICE COMPLETO DEL PRODOTTO NELLA FOTO
FULL PRODUCT CODE AS SHOWN IN PICTURE - VOLLSTÄNDIGER CODE VOM ARTIKEL IM BILD

1064GTF NF E2 B

Codice Code	Finitura Finishing Lackierung	Diffusore Diffuser Diffusor	Tonalità Hue Farbton
----------------	-------------------------------------	-----------------------------------	----------------------------

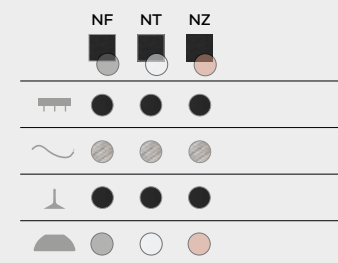

A Alimentatore nel rosone - Power Supply inside the ceiling rose - Netzteil in der Deckendose
TF Taglio di Fase - Phase-Cut Dimmer - Phasenabschrittdimmer

* 800lm effettivi - effective - effektiven con - with - mit **E2**

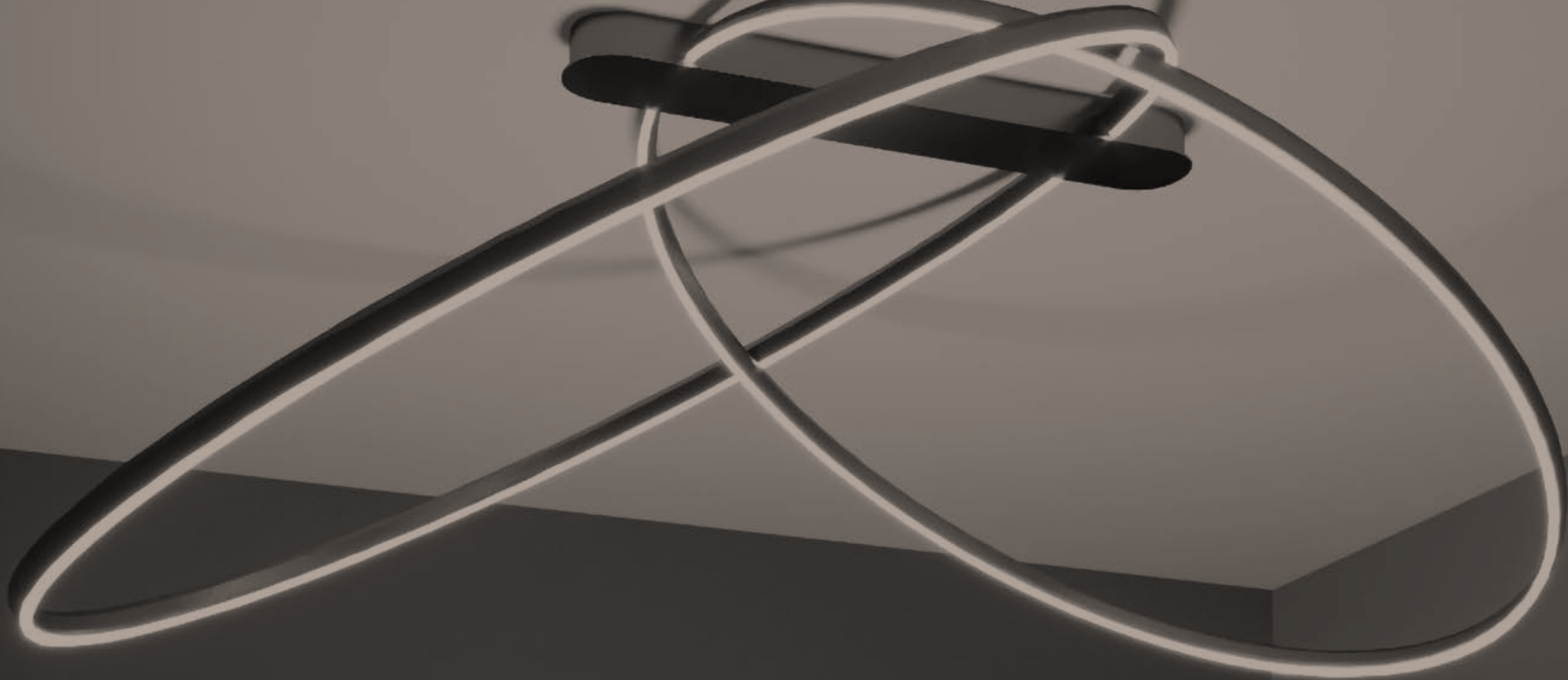

PLAFONE
CEILING LIGHT
DECKENLEUCHTE





Bellai 187
downlight Ø70/Ø95



Bellai 189
downlight Ø130/Ø180



Bellai Home 191
downlight Ø58/Ø70/Ø95



Bellai Home 193
up+downlight Ø58/Ø70/Ø95



Overlap Decò 235
up+downlight 75x133

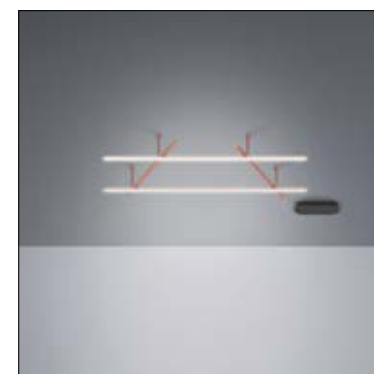

Overlap Decò 235
up+downlight 94,5x94,5

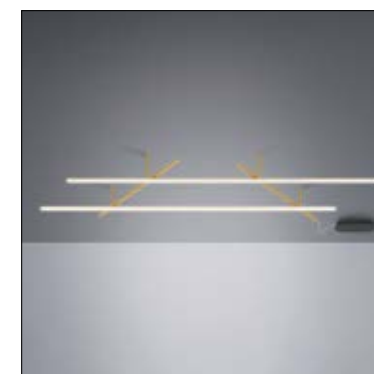

Overlap Decò 235
up+downlight 87x184



Kasaa 203
downlight Ø20/Ø40/Ø55



Chapeau 195
downlight Ø42



Chapeau 195
downlight Ø60



Compact 197
omni-light L10x10/L20x20



Compact 197
omni-light L25x25/L40x40



Compact 197
omni-light L40x10/L60x10



Edge 199
downlight downlight 59x59/115x31



Iglù 201
downlight Ø25/Ø40



Leggera 205
downlight inclinato Ø65/Ø82

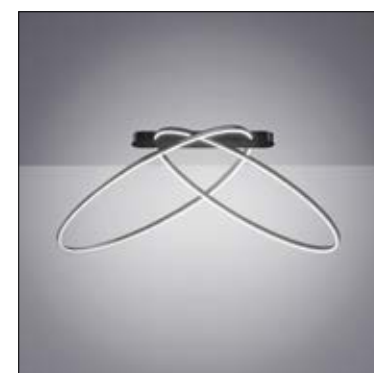

Leggera 207
downlight composizione Ø45+Ø65/Ø65+Ø82



Leggera 209
downlight L170



Micro 211
orientabile 1x3W



Micro 211
orientabile 2x3W



Micro 213
orientabile + downlight 2x3W+15W



Mirò Home 215
downlight + spotlight



Operà 219
orientabile spotlight 1x7W



Operà 219
orientabile spotlight 2x7W



Operà 219
orientabile spotlight 3x7W



Operà 221
orientabile + downlight 2x7W+25W



Omnia 217
downlight L28/L56



Omnia 217
downlight L112/L168/L225



Oki 223
downlight L4x4 H7

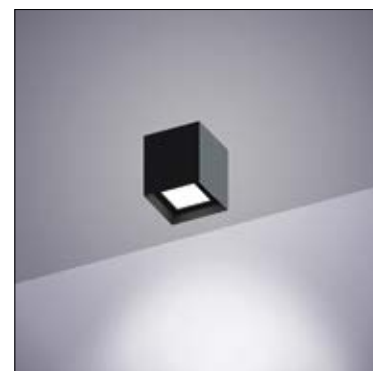

Oki 223
downlight L8x8 H9



Oki 223
downlight L15x15 H8



Oki 225
downlight L15x15 H17



Overlap 233
orientabile L90+L131/L90+L181



Overlap 233
orientabile L90+2*L181



Oki 227
up+downlight L15x15 H20,5



Oki 229
downlight L30x30



Oki 229
downlight L55x55



Oki 229
downlight L30x105



Pleni 237
downlight Ø38/Ø58/Ø88



Pleni 237
downlight Ø58/Ø88 Plafone staffa



Oki 231
downlight doppio 2*L8x8 H9



Oki 231
downlight triplo 2*L8x8 H9+L15x15 H8



Shape 239
downlight L55x55/L85x85



S-Pot Home 241
downlight Ø5,4 L15 / L30 - GU10



S-Pot Home 241
downlight Ø5,4 L60 / L90 - GU10



S-Pot 243
downlight Ø11 L12-17W/L22-26W



S-Pot 245
downlight Ø18,5 - 26W



Tablet Round 247
orientabile Ø9 1x7W



Tablet Round 247
orientabile Ø9 2x7W



Tablet Round 247
orientabile Ø32 3x7W



Tablet Round 249
orientabile + downlight 2x7W+25W



Tablet Round 251
orientabile 1x7W Ø9 GU10



Tablet Round 251
orientabile 2x7W Ø9 GU10



Tablet Square 253
orientabile L8x8 - 1x7W



Tablet Square 253
orientabile 2x7W L8x16



Tablet Square 253
orientabile 4x7W L28x28



Tablet Square 255
orientabile L8x8 - 1x7W GU10



Tablet Square 255
orientabile spotlight 2x7W GU10



Task 257
downlight L4x12 H7 - 10W



Task 257
downlight L8x8 H8 - 12W



Velata 259
uplight Ø58/Ø73/Ø95

configurazione standard: / basic configuration: / Standard Konfiguration:

E2 Opale - Opal ● B 3000K

BV

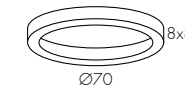

3025AOFBVE2B	50W 3810lm* - 220V	1.006,00 €
3025ADMBVE2B	DALI (Push) - 50W 3810lm - 220V	1.139,00 €
3025AOFEMBVE2B	50W 3810m - 220V	1.194,00 €

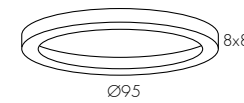

3025BOFBVE2B	65W 5170lm - 220V	1.287,00 €
3025BDMBVE2B	DALI (Push) - 65W 5170lm - 220V	1.441,00 €
3025BOFEMBVE2B	65W 5170lm - 220V	1.475,00 €

Configura Configure / Konfigurieren

www.teamitaliailluminazione.it



E19 UGR<19 Prism ● A 2700K C 4000K

NE RU

↑ CODICE COMPLETO DEL PRODOTTO NELLA FOTO
FULL PRODUCT CODE AS SHOWN IN PICTURE
VOLLSTÄNDIGER CODE VOM ARTIKEL IM BILD

3025BOF **BV** **E2** **B**

Codice Code	Finitura Finishing Lackierung	Diffusore Diffuser Diffusor	Tonalità Hue Farbton
----------------	-------------------------------------	-----------------------------------	----------------------------

EM Emergenza - Emergency - Notbeleuchtung
A Alimentatore Incorporato - Incorporated Power Supply - Eingebautes Netzteil

* 3810lm effettivi - effective - effektive con - with - mit **E2**
4480lm effettivi - effective - effektive con - with - mit **E19** **+17,5%**

configurazione standard: / basic configuration: / Standard Konfiguration:

E2 Opale - Opal

● B 3000K

BV

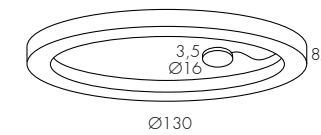

3025COFBVE2B

92W 7355lm* - 220V

2.122,00 €

3025CDMBVE2B

DALI (Push) - 92W 7355lm - 220V

2.296,00 €

3025COFEMBVE2B

92W 7355lm - 220V

2.313,00 €

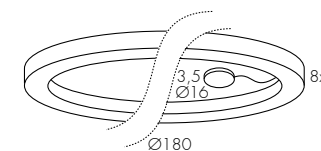

3025DOFBVE2B

160W 12950lm - 220V

2.921,00 €

3025DDMBVE2B

DALI (Push) - 160W 12950lm - 220V

3.156,00 €

3025DOFEMBVE2B

160W 12950lm - 220V

3.125,00 €

Configura 

Configure / Konfigurieren

www.teamitaliailluminazione.it 



E19 UGR<19 Prism

● A 2700K ○ C 4000K

NE RU 

 **CODICE COMPLETO DEL PRODOTTO NELLA FOTO**
FULL PRODUCT CODE AS SHOWN IN PICTURE - VOLLSTÄNDIGER CODE VOM ARTIKEL IM BILD

3025COF | **NE** | **E2** | **B**

Codice
Code

Finitura
Finishing
Lackierung

Diffusore
Diffuser
Diffusor

Tonalità
Hue
Farbton

EM Emergenza - Emergency - Notbeleuchtung

A Alimentatore Incorporato - Incorporated Power Supply - Eingebautes Netzteil

* 7355lm effettivi - effective - effektive con - with - mit **E2**
8650lm effettivi - effective - effektive con - with - mit **E19**  **+17,5%**



configurazione standard: / basic configuration: / Standard Konfiguration:

E2 Opale - Opal

● B 3000K

BV

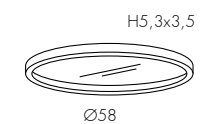

3027EOFBVE2B
3027EDMBVE2B
3027ETFBVE2B

45W 3230lm* - 220V
DALI (Push) - 45W 3230lm - 220V
45W 3230lm - 220V

692,00 €
780,00 €
780,00 €

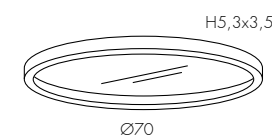

3027COFBVE2B
3027CDMBVE2B
3027CBTBVE2B

50W 3808lm - 220V
DALI (Push) - 50W 3808lm - 220V
Bluetooth 50W 3808lm - 220V

803,00 €
895,00 €
895,00 €

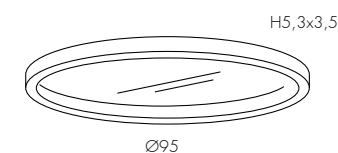

3027FOFBVE2B
3027FDMBVE2B
3027FBTBVE2B

65W 5168lm - 220V
DALI (Push) - 65W 5168lm - 220V
Bluetooth 65W 5168lm - 220V

1.014,00 €
1.103,00 €
1.103,00 €

Configura

Configure / Konfigurieren

www.teamitaliailluminazione.it



E19 UGR<19 Prism

● A 2700K

NE RU



CODICE COMPLETO DEL PRODOTTO NELLA FOTO
FULL PRODUCT CODE AS SHOWN IN PICTURE - VOLLSTÄNDIGER CODE VOM ARTIKEL IM BILD

3027COF **BV** **E2** **B**

Codice
Code

Finitura
Finishing
Lackierung

Diffusore
Diffuser
Diffusor

Tonalità
Hue
Farbton

TF Taglio di Fase - Phase-Cut Dimmer - Phasenabschnittdimmer

A Alimentatore Incorporato - Incorporated Power Supply - Eingebautes Netzteil

BT Bluetooth - Bluetooth - Bluetooth

* 3230lm effettivi - effective - effektive con - with - mit **E2**
3800lm effettivi - effective - effektive con - with - mit **E19** **+17,5%**

INDEX

SECTION

FAMILY 191



configurazione standard: / basic configuration: / Standard Konfiguration:

E2 Opale - Opal

 B 3000K

BV

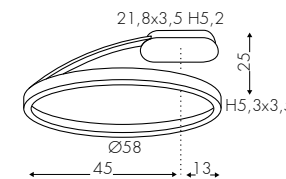

3027DOFBVE2B

42W 3247lm* + 15.4W 1300lm - 220V

705,00 €

3027DDMBVE2B

DALI (Push) 42W 3247lm + 15.4W 1300lm - 220V

754,00 €

3027DTFBVE2B

42W 3247lm + 15.4W 1300lm - 220V

754,00 €

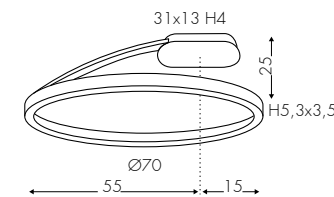

3027AOFBVE2B

50W 3808lm + 24W 2400lm - 220V

818,00 €

3027ADMBVE2B

DALI (Push) - 50W 3808lm + 24W 2400lm - 220V

906,00 €

3027ABTBVE2B

Bluetooth 50W 3808lm + 24W 2400lm - 220V

906,00 €

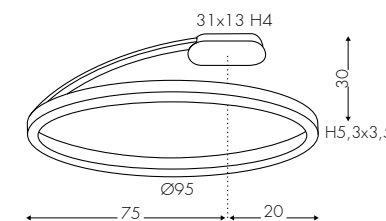

3027BOFBVE2B

65W 5168lm + 24W 2400lm - 220V

937,00 €

3027BDMBVE2B

DALI (Push) - 65W 5168lm + 24W 2400lm - 220V

1.029,00 €

3027BBTBVE2B

Bluetooth 65W 5168lm + 24W 2400lm - 220V

1.029,00 €

Configura 

Configure / Konfigurieren

www.teamitaliailluminazione.it 



A E19 UGR<19 Prism

 A 2700K



 **CODICE COMPLETO DEL PRODOTTO NELLA FOTO**
FULL PRODUCT CODE AS SHOWN IN PICTURE - VOLLSTÄNDIGER CODE VOM ARTIKEL IM BILD

3027BOF **NE** **E2** **B**

Codice
Code

Finitura
Finishing
Lackierung

Diffusore
Diffuser
Diffusor

Tonalità
Hue
Farbton

TF Taglio di Fase - Phase-Cut Dimmer - Phasenabschrittdimmer

A Alimentatore nel rosone - Power Supply inside the ceiling rose - Netzteil in der Deckendose

BT Bluetooth - Bluetooth - Bluetooth

* 3247lm effettivi - effective - effektive con - with - mit **E2**
3815lm effettivi - effective - effektive con - with - mit **E19**  **+17,5%**



configurazione standard: / basic configuration: / Standard Konfiguration:

E2 Opale - Opal

● B 3000K

BV

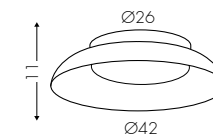

3087BTFBVE2B

18W 1620lm* - 220V

370,00 €

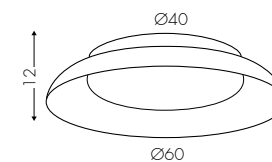

3087DTFBVE2B

30W 3000lm - 220V

495,00 €

Configura 

Configure / Konfigurieren

www.teamitaliailluminazione.it 



 **CODICE COMPLETO DEL PRODOTTO NELLA FOTO**
FULL PRODUCT CODE AS SHOWN IN PICTURE - VOLLSTÄNDIGER CODE VOM ARTIKEL IM BILD

3087DTF **OV** **E2** **B**

Codice
Code

Finitura
Finishing
Lackierung

Diffusore
Diffuser
Diffusor

Tonalità
Hue
Farbton

TF Taglio di Fase - Phase-Cut Dimmer - Phasenabschnittdimmer

A Alimentatore Incorporato - Incorporated Power Supply - Eingebautes Netzteil

* 1620lm effettivi - effective - effektiven con - with - mit **E2**



configurazione standard: / basic configuration: / Standard Konfiguration:

E2 Opale - Opal

BV

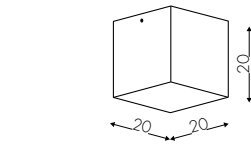

E321BVE2 1x E27 max 70W ES / 10W LED - 220V **262,00 €**
[Configura](#) Configure / Konfigurieren www.teamitaliailluminazione.it

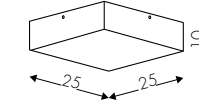

E322BVE2 2x E27 max 42W ES / 10W LED - 220V **262,00 €**
[Configura](#) Configure / Konfigurieren www.teamitaliailluminazione.it

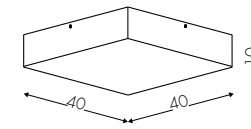

E323BVE2 3x E27 max 42W ES / 10W LED - 220V **512,00 €**
E27 Sorgente E27 non inclusa - E27 light source not included - E27 Lichtquelle nicht enthalten
[Configura](#) Configure / Konfigurieren www.teamitaliailluminazione.it



BV

configurazione standard: / basic configuration: / Standard Konfiguration:

E2 Opale - Opal

B 3000K

BV



E320BVE2B 4W 350lm* - 220V **182,00 €**
[Configura](#) Configure / Konfigurieren www.teamitaliailluminazione.it

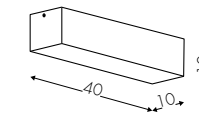

D322BVE2B 21W 2420lm - 220V **392,00 €**
D322DMBVE2B DALI (Push) - 21W 2420lm - 220V **462,00 €**
[Configura](#) Configure / Konfigurieren www.teamitaliailluminazione.it

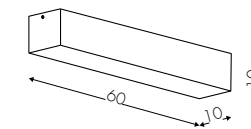

D323BVE2B 29W 3400lm - 220V **512,00 €**
D323DMBVE2B DALI (Push) - 29W 3400lm - 220V **597,00 €**

[Configura](#) Configure / Konfigurieren www.teamitaliailluminazione.it



A 2700K

BV

A Alimentatore Incorporato - Incorporated Power Supply - Eingebautes Netzteil

* 350lm effettivi - effective - effektive con - with - mit **E2**

CODICE COMPLETO DEL PRODOTTO NELLA FOTO
FULL PRODUCT CODE AS SHOWN IN PICTURE - VOLLSTÄNDIGER CODE VOM ARTIKEL IM BILD

E321

Codice
Code

BV

Finitura
Finishing
Lackierung

E2

Diffusore
Diffuser
Diffusor



configurazione standard: / basic configuration: / Standard Konfiguration:

E2 Opale - Opal

● B 3000K

BV

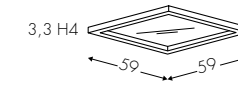

3028IOFBVE2B
3028IDMBVE2B

50W 3100lm* - 220V
DALI (Push) - 50W 3100lm - 220V

833,00 €
932,00 €

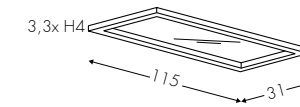

3028EOFBVE2B
3028EDMBVE2B

62W 4560lm - 220V
DALI (Push) - 62W 4560lm - 220V

877,00 €
977,00 €

Configura  Configure / Konfigurieren

www.teamitaliailluminazione.it 



E19 Prismatico - Prism

● A 2700K

NE RU

A Alimentatore Incorporato - Incorporated Power Supply - Eingebautes Netzteil

* 3100lm effettivi - effective - effektive con - with - mit **E2**
3650lm effettivi - effective - effektive con - with - mit **E19** ↻ +17,5%

 **CODICE COMPLETO DEL PRODOTTO NELLA FOTO**
FULL PRODUCT CODE AS SHOWN IN PICTURE - VOLLSTÄNDIGER CODE VOM ARTIKEL IM BILD

3028EOF **NE** **E2** **B**

Codice
Code

Finitura
Finishing
Lackierung

Diffusore
Diffuser
Diffusor

Tonalità
Hue
Farbton



configurazione standard: / basic configuration: / Standard Konfiguration:

E2 Opale - Opal ● B 3000K

BV

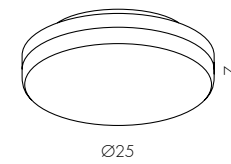

3080BOFBVE2B

12W 1300lm* - 220V

78,00 €

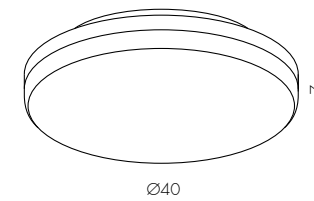

3080DOFBVE2B

30W 3000lm - 220V

148,00 €

Configura

Configure / Konfigurieren

www.teamitaliailluminazione.it

BV



A Alimentatore Incorporato - Incorporated Power Supply - Eingebautes Netzteil

* 1300lm effettivi - effective - effektiven con - with - mit **E2**

CODICE COMPLETO DEL PRODOTTO NELLA FOTO
FULL PRODUCT CODE AS SHOWN IN PICTURE - VOLLSTÄNDIGER CODE VOM ARTIKEL IM BILD

3080DOF **BV** **E2** **B**

Codice Code	Finitura Finishing Lackierung	Diffusore Diffuser Diffusor	Tonalità Hue Farbton
----------------	-------------------------------------	-----------------------------------	----------------------------



configurazione standard: / basic configuration: / Standard Konfiguration:

E2 Opale - Opal ● B 3000K

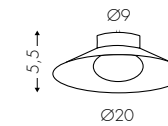

3076ATFNEE2B

10W 650lm* - 220V

198,00 €

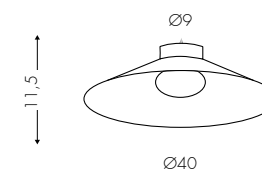

3076CTFNEE2B

17W 1100lm - 220V

315,00 €

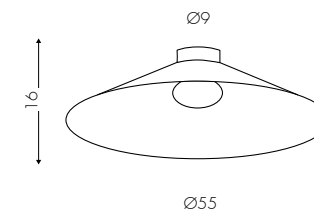

3076DTFNEE2B

17W 1100lm - 220V

368,00 €

Configura Configure / Konfigurieren

www.teamitaliailluminazione.it



● A 2700K



CODICE COMPLETO DEL PRODOTTO NELLA FOTO
FULL PRODUCT CODE AS SHOWN IN PICTURE - VOLLSTÄNDIGER CODE VOM ARTIKEL IM BILD

3076CTF **ZN** **E2** **A**

Codice Code	Finitura Finishing Lackierung	Diffusore Diffuser Diffusor	Tonalità Hue Farbton
----------------	-------------------------------------	-----------------------------------	----------------------------

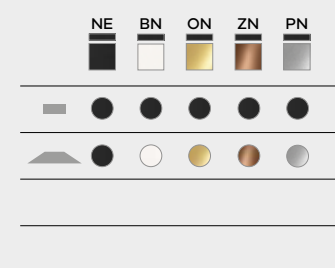

TF Taglio di Fase - Phase-Cut Dimmer - Phasenabschnittdimmer
A Alimentatore Incorporato - Incorporated Power Supply - Eingebautes Netzteil

* 650lm effettivi - effective - effektiven con - with - mit **E2**

LEGGERA

PLAFONE
CEILING LIGHT
DECKENLEUCHE



configurazione standard: / basic configuration: / Standard Konfiguration:

E2 Opale - Opal

● B 3000K

BV

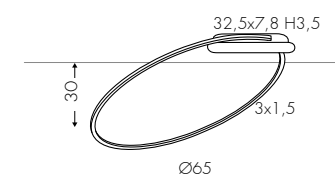

3032AOFBVE2B

35W 1740lm* - 220V

601,00 €

3032ADMBVE2B

DALI (Push) - 35W 1740lm - 220V

697,00 €

3032ATFBVE2B

35W 1740lm - 220V

697,00 €

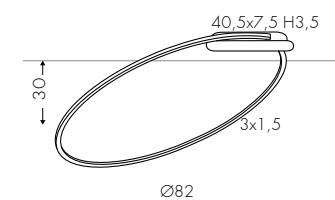

3032BOFBVE2B

48W 2580lm - 220V

709,00 €

3032BDMBVE2B

DALI (Push) - 48W 2580lm - 220V

808,00 €

3032BTFBVE2B

48W 2580lm - 220V

808,00 €

Configura

Configure / Konfigurieren

www.teamitaliailluminazione.it



● A 2700K

NE RV BR OV

CODICE COMPLETO DEL PRODOTTO NELLA FOTO
FULL PRODUCT CODE AS SHOWN IN PICTURE - VOLLSTÄNDIGER CODE VOM ARTIKEL IM BILD

3032BOF | **BR** | **E2** | **B**

Codice
Code

Finitura
Finishing
Lackierung

Diffusore
Diffuser
Diffusor

Tonalità
Hue
Farbton

TF Taglio di Fase - Phase-Cut Dimmer - Phasenabschnittdimmer

A Alimentatore Incorporato - Incorporated Power Supply - Eingebautes Netzteil

* 1740lm effettivi - effective - effektive con - with - mit **E2**

LEGGERA

PLAFONE
CEILING LIGHT
DECKENLEUCHE



configurazione standard: / basic configuration: / Standard Konfiguration:

E2 Opale - Opal

● B 3000K

BV

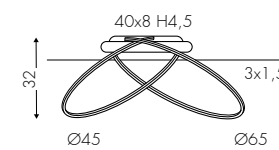

3032ACTFBVE2B

60W 2976lm* - 220V

979,00 €

3032ACDMBVE2B

DALI (Push) - 60W 2976lm - 220V

979,00 €

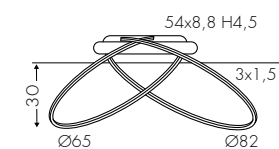

3032ABOFBVE2B

83W 4320lm - 220V

1.236,00 €

3032ABDMBVE2B

DALI (Push) - 83W 4320lm - 220V

1.380,00 €

3032ABTFBVE2B

83W 4320lm - 220V

1.380,00 €

Configura

Configure / Konfigurieren

www.teamitaliailluminazione.it



● A 2700K



CODICE COMPLETO DEL PRODOTTO NELLA FOTO
FULL PRODUCT CODE AS SHOWN IN PICTURE - VOLLSTÄNDIGER CODE VOM ARTIKEL IM BILD

3032ABOF **RV** **E2** **B**

Codice
Code

Finitura
Finishing
Lackierung

Diffusore
Diffuser
Diffusor

Tonalità
Hue
Farbton

TF Taglio di Fase - Phase-Cut Dimmer - Phasenabschnittdimmer

A Alimentatore Incorporato - Incorporated Power Supply - Eingebautes Netzteil

* 2976lm effettivi - effective - effektive con - with - mit **E2**



LEGGERA

PLAFONE
CEILING LIGHT
DECKENLEUCHTE



configurazione standard: / basic configuration: / Standard Konfiguration:

E2 Opale - Opal

● B 3000K

BV



3032GOFBVE2B

35W 1740lm* - 220V

493,00 €

3032GDMBVE2B

DALI (Push) - 35W 1740lm - 220V

586,00 €

3032GTFBVE2B

35W 1740lm - 220V

586,00 €

Configura

Configure / Konfigurieren

www.teamitaliailluminazione.it



● A 2700K



CODICE COMPLETO DEL PRODOTTO NELLA FOTO
FULL PRODUCT CODE AS SHOWN IN PICTURE - VOLLSTÄNDIGER CODE VOM ARTIKEL IM BILD

3032GOF **NE** **E2** **B**

Codice
Code

Finitura
Finishing
Lackierung

Diffusore
Diffuser
Diffusor

Tonalità
Hue
Farbton

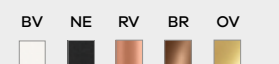

TF Taglio di Fase - Phase-Cut Dimmer - Phasenabschnittdimmer

A Alimentatore nel rosone - Power Supply inside the ceiling rose - Netzteil in der Deckendose

* 1740lm effettivi - effective - effektive con - with - mit **E2**

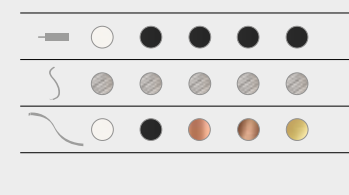

INDEX

SECTION

FAMILY 209

MICRO

PLAFONE
CEILING LIGHT
DECKENLEUCHE



configurazione standard: / basic configuration: / Standard Konfiguration:

24° Ottica - Optic - Optik ● B 3000K

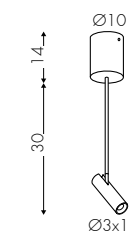

3039AOFBV24B	3W 360lm* - 220V	257,00 €
3039ADMBV24B	DALI (Push) - 3W 360lm - 220V	318,00 €
3039ATFBV24B	3W 360lm - 220V	282,00 €

Configura Configure / Konfigurieren

www.teamitaliailluminazione.it

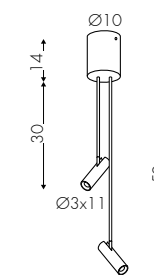

3039BOFBV24B	2x3W 2x360lm - 220V	351,00 €
3039BDMBV24B	DALI (Push) - 2x3W 2x360lm - 220V	398,00 €
3039BTFBV24B	2x3W 2x360lm - 220V	374,00 €

Configura Configure / Konfigurieren

www.teamitaliailluminazione.it



C 4000K



TF Taglio di Fase - Phase-Cut Dimmer - Phasenabschnittdimmer
A Alimentatore Incorporato - Incorporated Power Supply - Eingebautes Netzteil

* 360lm effettivi - effective - effektive con - with - mit 24°

CODICE COMPLETO DEL PRODOTTO NELLA FOTO
FULL PRODUCT CODE AS SHOWN IN PICTURE - VOLLSTÄNDIGER CODE VOM ARTIKEL IM BILD

3039BOF **NE** **24** **B**

Codice Code	Finitura Finishing Lackierung	Diffusore Diffuser Diffusor	Tonalità Hue Farbton
----------------	-------------------------------------	-----------------------------------	----------------------------



MICRO

PLAFONE
CEILING LIGHT
DECKENLEUCHTE



configurazione standard: / basic configuration: / Standard Konfiguration:

+ E2 Opale - Opal
24° Ottica - Optic - Optik

B 3000K

BV

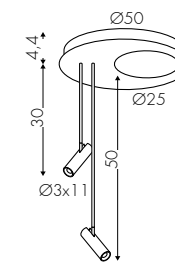

3039EOFBV24B	2x3W 2x360lm* + 15W 1500lm - 220V	557,00 €
3039EDMBV24B	DALI (Push) - 2x3W 2x360lm + 15W 1500lm - 220V	610,00 €
3039ETFBV24B	2x3W 2x360lm + 15W 1500lm - 220V	637,00 €

Configura Configure / Konfigurieren

www.teamitaliailluminazione.it



C 4000K



CODICE COMPLETO DEL PRODOTTO NELLA FOTO
FULL PRODUCT CODE AS SHOWN IN PICTURE - VOLLSTÄNDIGER CODE VOM ARTIKEL IM BILD

3039EOF **ON** **24** **C**

Codice
Code

Finitura
Finishing
Lackierung

Diffusore
Diffuser
Diffusor

Tonalità
Hue
Farbton

TF Taglio di Fase - Phase-Cut Dimmer - Phasenabschnittdimmer
A Alimentatore Incorporato - Incorporated Power Supply - Eingebautes Netzteil

* 360lm effettivi - effective - effektive con - with - mit **24**



configurazione standard: / basic configuration: / Standard Konfiguration:

+ E2 Opale - Opal
24° Ottica - Optic - Optik

B 3000K

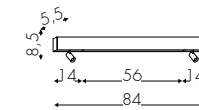

3030A11OFBVE2B
3030A11DMBVE2B

Spot 2x7W 2x680lm - 18W 1770lm* - 220V
DALI (Push) - Spot 2x7W 2x680lm - 18W 1770lm - 220V

638,00 €
895,00 €

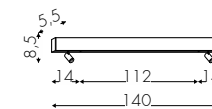

3030C11OFBVE2B
3030C11DMBVE2B

Spot 2x7W 2x680lm - 35W 3009lm - 220V
DALI (Push) - Spot 2x7W 2x680lm - 35W 3009lm - 220V

852,00 €
1.146,00 €

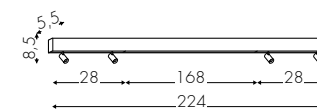

3030F22OFBVE2B
3030F22DMBVE2B

Spot 4x7W 4x680lm - 53W 4513lm - 220V
DALI (Push) - Spot 4x7W 4x680lm - 53W 4513lm - 220V

1.135,00 €
1.491,00 €

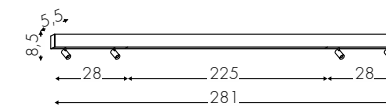

3030H22OFBVE2B
3030H22DMBVE2B

Spot 4x7W 4x680lm - 70W 6020lm - 220V
DALI (Push) - Spot 4x7W 4x680lm - 70W 6020lm - 220V

1.548,00 €
1.914,00 €

Configura Configure / Konfigurieren

www.teamitaliailluminazione.it



B 3000K



A Alimentatore Incorporato - Incorporated Power Supply - Eingebautes Netzteil

* 1770lm effettivi - effective - effektive con - with - mit E2



CODICE COMPLETO DEL PRODOTTO NELLA FOTO
FULL PRODUCT CODE AS SHOWN IN PICTURE - VOLLSTÄNDIGER CODE VOM ARTIKEL IM BILD

3030F22OF **NE** **E2** **B**

Codice
Code

Finitura
Finishing
Lackierung

Diffusore
Diffuser
Diffusor

Tonalità
Hue
Farbton



configurazione standard: / basic configuration: / Standard Konfiguration:

E2 Opale - Opal

● B 3000K

BV

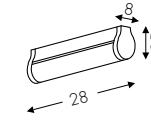

3060ATFBVE2B

7W 714lm* - 220V

188,00 €

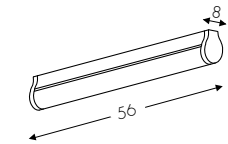

3060STFBVE2B

13W 1428lm - 220V

228,00 €

3060SDMBVE2B

DALI (Push) 13W 1428lm - 220V

272,00 €

Configura

Configure / Konfigurieren

www.teamitaliailluminazione.it

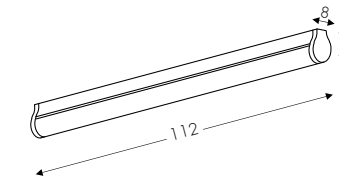

3060BOFBVE2B

25W 2856lm - 220V

299,00 €

3060BDMBVE2B

DALI (Push) - 25W 2856lm - 220V

350,00 €

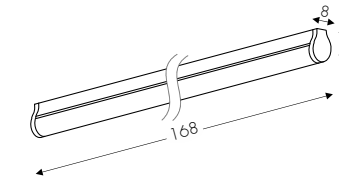

3060DOFBVE2B

37W 4290lm - 220V

345,00 €

3060DDMBVE2B

DALI (Push) - 37W 4290lm - 220V

399,00 €

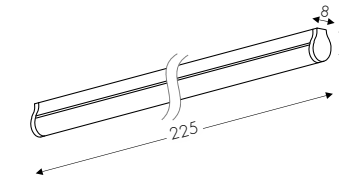

3060FOFBVE2B

50W 5738lm - 220V

437,00 €

3060FDMBVE2B

DALI (Push) - 50W 5738lm - 220V

495,00 €

Configura

Configure / Konfigurieren

www.teamitaliailluminazione.it



● A 2700K ○ C 4000K

NE

CODICE COMPLETO DEL PRODOTTO NELLA FOTO
FULL PRODUCT CODE AS SHOWN IN PICTURE - VOLLSTÄNDIGER CODE VOM ARTIKEL IM BILD

3060DTF **NE** **E2** **B**

Codice
Code

Finitura
Finishing
Lackierung

Diffusore
Diffuser
Diffusor

Tonalità
Hue
Farbton

TF Taglio di Fase - Phase-Cut Dimmer - Phasenabschnittdimmer

A Alimentatore Incorporato - Incorporated Power Supply - Eingebautes Netzteil

* 714lm effettivi - effective - effektive con - with - mit **E2**



configurazione standard: / basic configuration: / Standard Konfiguration:

24° Ottica - Optic - Optik ● B 3000K

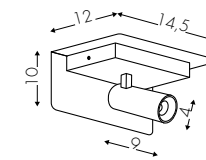

3033AOFBV24B 1x7W 680lm* - 220V

179,00 €

3033ATFBV24B 1x7W 680lm - 220V

196,00 €

Configura Configure / Konfigurieren

www.teamitaliailluminazione.it

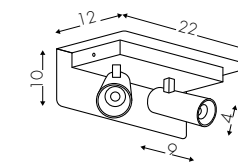

3033BOFBV24B 2x7W 2x680lm - 220V

276,00 €

3033BDMBV24B DALI (Push) - 2x7W 2x680lm - 220V

318,00 €

3033BTFBV24B 2x7W 2x680lm - 220V

285,00 €

Configura Configure / Konfigurieren

www.teamitaliailluminazione.it

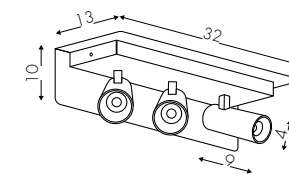

3033COFBV24B 3x7W 3x680lm - 220V

333,00 €

3033CDMBV24B DALI (Push) - 3x7W 3x680lm - 220V

386,00 €

3033CTFBV24B 3x7W 3x680lm - 220V

370,00 €

Configura Configure / Konfigurieren

www.teamitaliailluminazione.it



C 4000K



CODICE COMPLETO DEL PRODOTTO NELLA FOTO
FULL PRODUCT CODE AS SHOWN IN PICTURE - VOLLSTÄNDIGER CODE VOM ARTIKEL IM BILD

3033BOF **NE** **24** **B**

Codice
Code

Finitura
Finishing
Lackierung

Diffusore
Diffuser
Diffusor

Tonalità
Hue
Farbton





configurazione standard: / basic configuration: / Standard Konfiguration:

+ E2 Opale - Opal
24° Ottica - Optic - Optik

B 3000K

BV

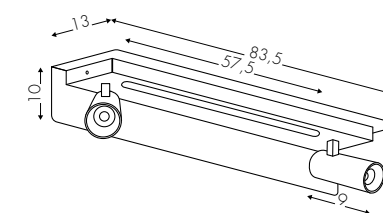

3033EOFBV24B	25W 2860lm + 2x7W 2x680lm* - 220V	364,00 €
3033EDMBV24B	DALI (Push) - 25W 2860lm + 2x7W 2x680lm - 220V	434,00 €
3033ETFVB24B	25W 2860lm + 2x7W 2x680lm - 220V	393,00 €

Configura Configure / Konfigurieren

www.teamitaliailluminazione.it



C 4000K



CODICE COMPLETO DEL PRODOTTO NELLA FOTO
FULL PRODUCT CODE AS SHOWN IN PICTURE - VOLLSTÄNDIGER CODE VOM ARTIKEL IM BILD

3033EOF **NE** **24** **B**

Codice
Code

Finitura
Finishing
Lackierung

Diffusore
Diffuser
Diffusor

Tonalità
Hue
Farbton

TF Taglio di Fase - Phase-Cut Dimmer - Erhältlich Phasenabschnittdimmer

A Alimentatore Incorporato - Incorporated Power Supply - Eingebautes Netzteil

* 680lm effettivi - effective - effektive con - with - mit 24°



configurazione standard: / basic configuration: / Standard Konfiguration:

E28 Satinato
Frosted - Satiniert ● B 3000K BV

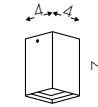

3009BTFBVE28B 4.3W 420lm* - 220V **110,00 €**
[Configura](#) Configure / Konfigurieren www.teamitaliailluminazione.it

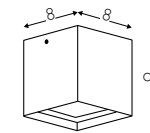

3009ATFBVE28B 13W 1000lm - 220V **134,00 €**
[Configura](#) Configure / Konfigurieren www.teamitaliailluminazione.it

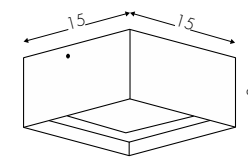

3009DTFBVE28B 20W 1700lm - 220V **184,00 €**

[Configura](#) Configure / Konfigurieren www.teamitaliailluminazione.it



CODICE COMPLETO DEL PRODOTTO NELLA FOTO
FULL PRODUCT CODE AS SHOWN IN PICTURE - VOLLSTÄNDIGER CODE VOM ARTIKEL IM BILD

3009ATF **BV** **E28** **B**

Codice Code	Finitura Finishing Lackierung	Diffusore Diffuser Diffusor	Tonalità Hue Farbton
----------------	-------------------------------------	-----------------------------------	----------------------------

TF Taglio di Fase - Phase-Cut Dimmer - Phasenabschnittdimmer
A Alimentatore Incorporato - Incorporated Power Supply - Eingebautes Netzteil

* 420lm effettivi - effective - effektive con - with - mit **E28**



configurazione standard: / basic configuration: / Standard Konfiguration:

E28 Satinato
Frosted - Satiniert

B 3000K

BV

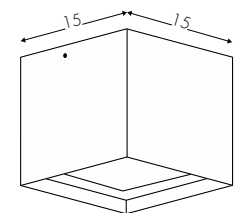

3009CTFBVE28B 20W 1700lm* - 220V

214,00 €

3009COFEMBVE28B 20W 1700lm - 220V

385,00 €

Configura Configure / Konfigurieren

www.teamitaliailluminazione.it



A 2700K **C** 4000K

NE **RU**

configurazione standard: / basic configuration: / Standard Konfiguration:

28° Ottica
Optics - Optik

B 3000K

BV

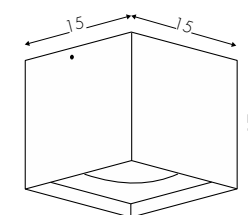

3009COF28BV28B 18W 2500lm - 220V

267,00 €

3009CDM28BV28B DALI (Push) - 18W 2500lm - 220V

299,00 €

3009CTF28BV28B 18W 2500lm - 220V

299,00 €

Configura Configure / Konfigurieren

www.teamitaliailluminazione.it



C 4000K

NE **RU**

CODICE COMPLETO DEL PRODOTTO NELLA FOTO
FULL PRODUCT CODE AS SHOWN IN PICTURE
VOLLSTÄNDIGER CODE VOM ARTIKEL IM BILD

3009CTF **BV** **E28** **B**

Codice
Code

Finitura
Finishing
Lackierung

Diffusore
Diffuser
Diffusor

Tonalità
Hue
Farbton

EM Emergenza - Emergency - Notbeleuchtung

TF Taglio di Fase - Phase-Cut Dimmer - Erhältlich Phasenabschnittdimmer

A Alimentatore Incorporato - Incorporated Power Supply - Eingebautes Netzteil

* 1700lm effettivi - effective - effektive con - with - mit **E28**



configurazione standard: / basic configuration: / Standard Konfiguration:

E28 Satinato
Frosted - Satiniert

B 3000K

BV

30090TFBVE28B

20W 1700lm* + 8W 950lm - 220V

286,00 €

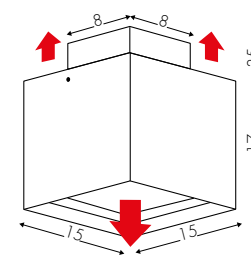

Configura

Configure / Konfigurieren

www.teamitaliailluminazione.it



A 2700K **C** 4000K

NE RU

CODICE COMPLETO DEL PRODOTTO NELLA FOTO
FULL PRODUCT CODE AS SHOWN IN PICTURE - VOLLSTÄNDIGER CODE VOM ARTIKEL IM BILD

30090TF **NE** **E28** **B**

Codice
Code

Finitura
Finishing
Lackierung

Diffusore
Diffuser
Diffusor

Tonalità
Hue
Farbton

TF Taglio di Fase - Phase-Cut Dimmer - Erhältlich Phasenabschnittdimmer

A Alimentatore Incorporato - Incorporated Power Supply - Eingebautes Netzteil

* 1700lm effettivi - effective - effektive con - with - mit **E28**



configurazione standard: / basic configuration: / Standard Konfiguration:

E2 Opale - Opal

● B 3000K

BV

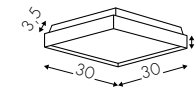

3009EOFBVE2B	18W 1870lm* - 220V	271,00 €
3009EDMBVE2B	DALI (Push) - 18W 1870lm - 220V	324,00 €
3009ETFBVE2B	18W 1870lm - 220V	302,00 €
3009EOFEMBVE2B	18W 1870lm - 220V	455,00 €

Configura Configure / Konfigurieren

www.teamitaliailluminazione.it

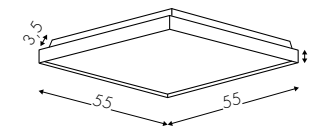

3009FOFBVE2B	50W 5270lm - 220V	476,00 €
3009FDMBVE2B	DALI (Push) - 50W 5270lm - 220V	535,00 €
3009FTFBVE2B	50W 5270lm - 220V	512,00 €
3009FOFEMBVE2B	50W 5270lm - 220V	649,00 €

Configura Configure / Konfigurieren

www.teamitaliailluminazione.it

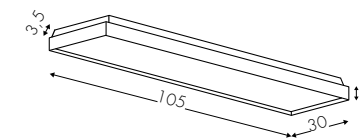

3009LOFBVE2B	50W 5270lm - 220V	476,00 €
3009LDMBVE2B	DALI (Push) - 50W 5270lm - 220V	535,00 €
3009LTFBVE2B	50W 5270lm - 220V	512,00 €
3009LOFEMBVE2B	50W 5270lm - 220V	649,00 €

Configura Configure / Konfigurieren

www.teamitaliailluminazione.it



E19 UGR<19 Prism

○ C 4000K

NE

CODICE COMPLETO DEL PRODOTTO NELLA FOTO
FULL PRODUCT CODE AS SHOWN IN PICTURE - VOLLSTÄNDIGER CODE VOM ARTIKEL IM BILD

3009FOF **NE** **E2** **B**

Codice
Code

Finitura
Finishing
Lackierung

Diffusore
Diffuser
Diffusor

Tonalità
Hue
Farbton

- EM** Emergenza - Emergency - Notbeleuchtung
- TF** Taglio di Fase - Phase-Cut Dimmer - Erhältlich Phasenabschrittdimmer
- A** Alimentatore Incorporato - Incorporated Power Supply - Eingebautes Netzteil

* 1870lm effettivi - effective - effektive con - with - mit **E2**
2200lm effettivi - effective - effektive con - with - mit **E19** **+17,5%**



RV custom finish

configurazione standard: / basic configuration: / Standard Konfiguration:

E28 Satinato
Frosted - Satiniert

B 3000K

BV

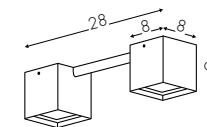

3009MTFBVE28B 26W 2000lm* - 220V

296,00 €

Configura Configura / Konfigurieren

www.teamitaliailluminazione.it

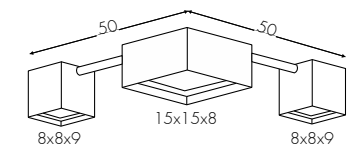

3009NTFBVE28B 43W 3500lm - 220V

477,00 €

Configura Configura / Konfigurieren

www.teamitaliailluminazione.it



NE RU

CODICE COMPLETO DEL PRODOTTO NELLA FOTO
FULL PRODUCT CODE AS SHOWN IN PICTURE - VOLLSTÄNDIGER CODE VOM ARTIKEL IM BILD

3009MTF **RV** **E28** **B**

Codice
Code

Finitura
Finishing
Lackierung

Diffusore
Diffuser
Diffusor

Tonalità
Hue
Farbton

TF Taglio di Fase - Phase-Cut Dimmer - Phasenabschnittdimmer

A Alimentatore Incorporato - Incorporated Power Supply - Eingebautes Netzteil

* 2000lm effettivi - effective - effektive con - with - mit **E28**



custom red cable

configurazione standard: / basic configuration: / Standard Konfiguration:

+ E2 Opale - Opal
E28 Satinato - Frosted - Satiniert ● B 3000K

BV

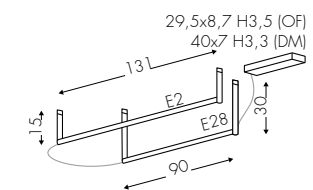

3015IOFBVE2B
3015IDMBVE2B

26W 2295lm + 38W 2730lm* - 220V
DALI (Push) - 26W 2295lm + 38W 2730lm - 220V

600,00 €
694,00 €

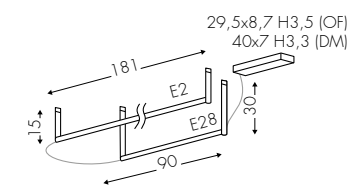

3015LOFBVE2B
3015LDMBVE2B

26W 2295lm + 52W 3780lm - 220V
DALI (Push) - 26W 2295lm + 52W 3780lm - 220V

686,00 €
794,00 €

Configura Configure / Konfigurieren

www.teamitaliailluminazione.it

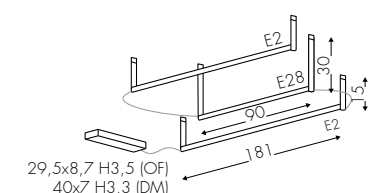

3015MOFBVE2B
3015MDMBVE2B

2x52W 7560lm + 26W 2295lm - 220V
DALI (Push) - 2x52W 7560lm + 26W 2295lm - 220V

967,00 €
1.097,00 €

● C005T2BV Custom white cable **8,00 € /MT**

● C005T2RO Custom red cable **8,00 € /MT**

Configura Configure / Konfigurieren

www.teamitaliailluminazione.it



BV

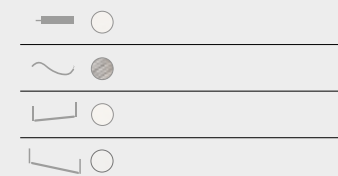

A Alimentatore nel rosone - Power Supply inside the ceiling rose - Netzteil in der Deckendose

* 2730lm effettivi - effective - effektive con - with - mit E2

CODICE COMPLETO DEL PRODOTTO NELLA FOTO
FULL PRODUCT CODE AS SHOWN IN PICTURE - VOLLSTÄNDIGER CODE VOM ARTIKEL IM BILD

3015IOF **BV** **E2** **B** + **C005T2RO**

Codice
Code

Finitura
Finishing
Lackierung

Diffusore
Diffuser
Diffusor

Tonalità
Hue
Farbton

Codice
Code

custom RED CABLE

OVERLAP DECÒ

PLAFONE
CEILING LIGHT
DECKENLEUCHE



configurazione standard: / basic configuration: / Standard Konfiguration:

E2 Opale - Opal

● B 3000K

BV

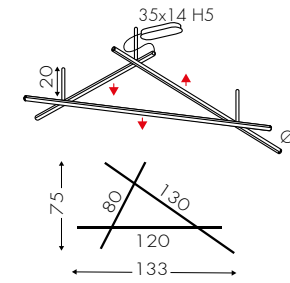

3015QTFBVE2B

75W 5500lm* - 220V

780,00 €

3015QDMBVE2B

DALI (Push) - 75W 5500lm - 220V

860,00 €

3015QSD BVE2B

75W 5500lm - 220V

860,00 €

Configura

Configure / Konfigurieren

www.teamitaliailluminazione.it

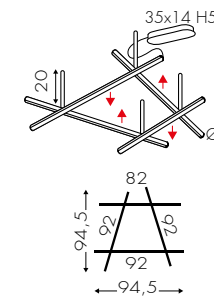

3015OTFBVE2B

78W 6000lm - 220V

780,00 €

3015ODMBVE2B

DALI (Push) - 78W 6000lm - 220V

860,00 €

3015OSD BVE2B

78W 6000lm - 220V

860,00 €

Configura

Configure / Konfigurieren

www.teamitaliailluminazione.it

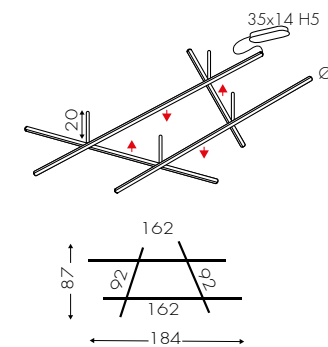

3015PTFBVE2B

110W 8500lm - 220V

890,00 €

3015PDMBVE2B

DALI (Push) - 110W 8500lm - 220V

970,00 €

3015PSD BVE2B

110W 8500lm - 220V

970,00 €

Configura

Configure / Konfigurieren

www.teamitaliailluminazione.it



● A 2700K



CODICE COMPLETO DEL PRODOTTO NELLA FOTO
FULL PRODUCT CODE AS SHOWN IN PICTURE - VOLLSTÄNDIGER CODE VOM ARTIKEL IM BILD

3015OTF BR E2 B

Codice Code	Finitura Finishing Lackierung	Diffusore Diffuser Diffusor	Tonalità Hue Farbton
----------------	-------------------------------------	-----------------------------------	----------------------------

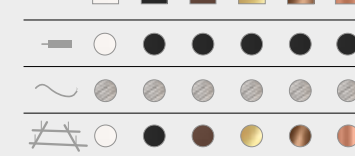
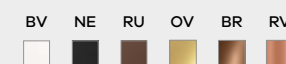

A Alimentatore nel rosone - Power Supply inside the ceiling rose - Netzteil in der Deckendose

TF Taglio di Fase - Phase-Cut Dimmer - Phasenabschnittdimmer

SD Telecomando radio - Smart Dimmer - Smart Dimmer

* 5500lm effettivi - effective - effektiven con - with - mit **E2**





configurazione standard: / basic configuration: / Standard Konfiguration:

E2 Opale - Opal

B 3000K

BV

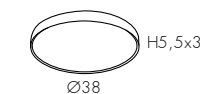

3067BOFBVE2B
3067BDMBVE2B

26W 3586lm* - 220V
DALI (Push) - 26W 3586lm - 220V

410,00 €
530,00 €

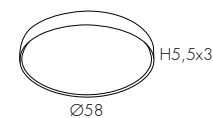

3067DOFBVE2B
3067DDMBVE2B

47W 6500lm - 220V
DALI (Push) - 47W 6500lm - 220V

595,00 €
695,00 €

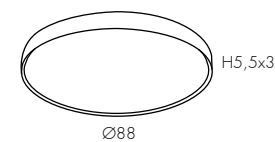

3067FOFBVE2B
3067FDMBVE2B

70W 8220lm - 220V
DALI (Push) - 70W 8220lm - 220V

890,00 €
990,00 €

Configura Configure / Konfigurieren

www.teamitaliailluminazione.it

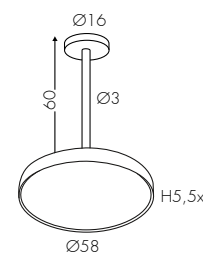

3067QOFBVE2B
3067QDMBVE2B

26W 3586lm - 220V
DALI (Push) - 26W 3586lm - 220V

675,00 €
775,00 €

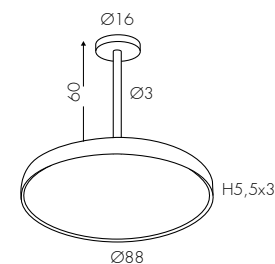

3067ROFBVE2B
3067RDMBVE2B

47W 6500lm - 220V
DALI (Push) - 47W 6500lm - 220V

970,00 €
1.070,00 €

Configura Configure / Konfigurieren

www.teamitaliailluminazione.it



E19 UGR<19 Prism

C 4000K

NE

A Alimentatore Incorporato - Incorporated Power Supply - Eingebautes Netzteil

* 3586lm effettivi - effective - effektive con - with - mit **E2**
4220lm effettivi - effective - effektive con - with - mit **E19** +17,5%

CODICE COMPLETO DEL PRODOTTO NELLA FOTO
FULL PRODUCT CODE AS SHOWN IN PICTURE - VOLLSTÄNDIGER CODE VOM ARTIKEL IM BILD

3067BOF **NE** **E2** **B**

Codice
Code

Finitura
Finishing
Lackierung

Diffusore
Diffuser
Diffusor

Tonalità
Hue
Farbton



SHAPE

PLAFONE
CEILING LIGHT
DECKENLEUCHTE



configurazione standard: / basic configuration: / Standard Konfiguration:

E2 Opale - Opal ● B 3000K

BV

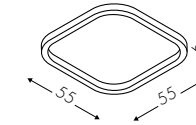

3031AOFBVE2B 52W 4510lm* - 220V 855,00 €
3031ADMBVE2B DALI (Push) - 52W 4510lm - 220V 936,00 €

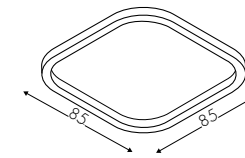

3031BOFBVE2B 83W 6800lm - 220V 1.493,00 €
3031BDMBVE2B DALI (Push) - 83W 6800lm - 220V 1.604,00 €

Configura Configure / Konfigurieren

www.teamitaliailluminazione.it



E19 UGR<19 Prism ● A 2700K C 4000K

NE RU

CODICE COMPLETO DEL PRODOTTO NELLA FOTO
FULL PRODUCT CODE AS SHOWN IN PICTURE - VOLLSTÄNDIGER CODE VOM ARTIKEL IM BILD

3031BOF **NE** **E2** **B**

Codice
Code

Finitura
Finishing
Lackierung

Diffusore
Diffuser
Diffusor

Tonalità
Hue
Farbton

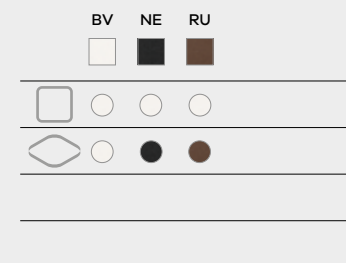

A Alimentatore Incorporato - Incorporated Power Supply - Eingebautes Netzteil

* 4510lm effettivi - effective - effektive con - with - mit **E2**
 5300lm effettivi - effective - effektive con - with - mit **E19** ↻ +17,5%

INDEX

SECTION

FAMILY 239

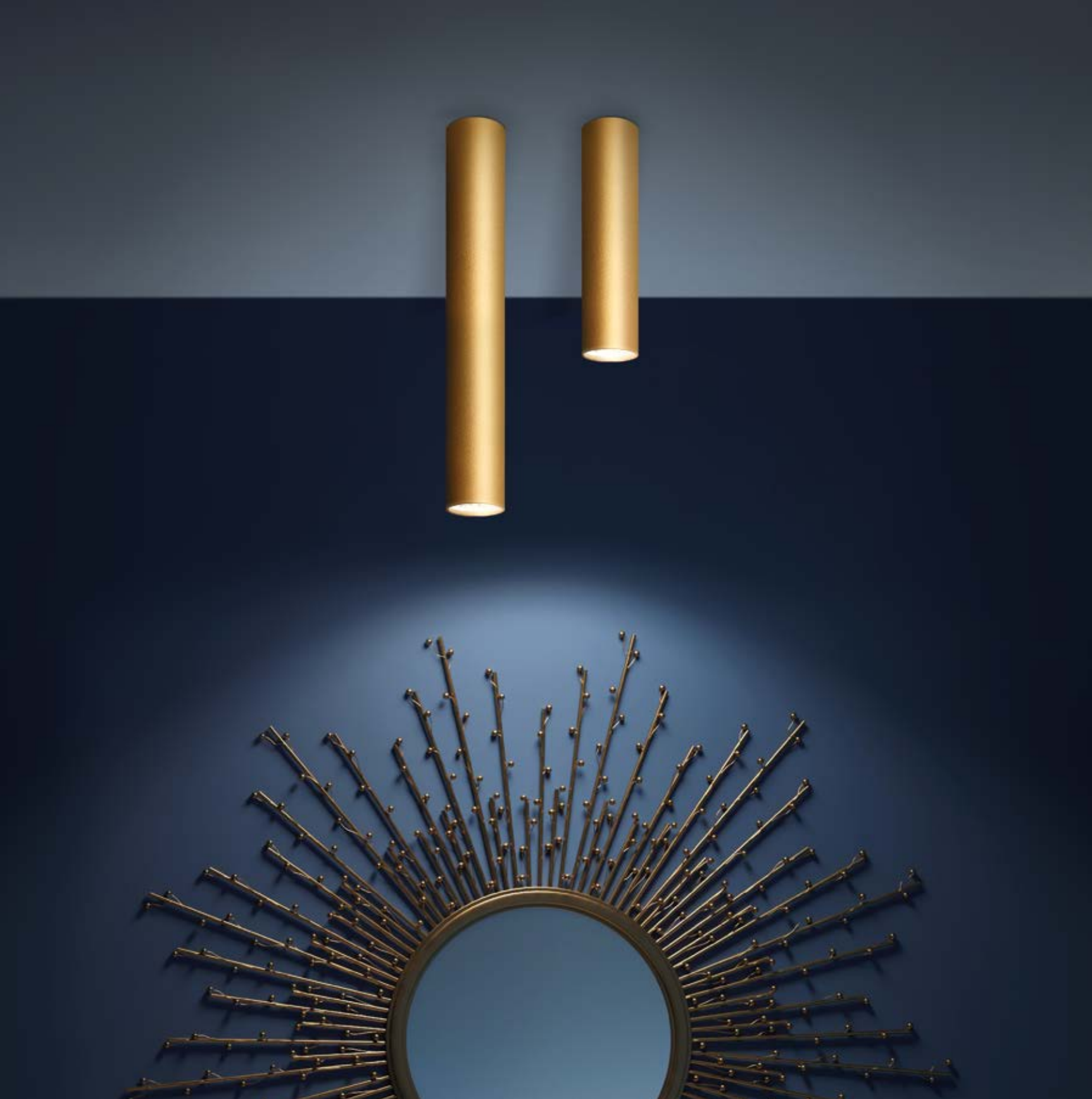

configurazione standard: / basic configuration: / Standard Konfiguration:

GU10

BV

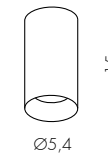

3018COFBV

1x GU10 max 7W LED - 220V

53,00 €

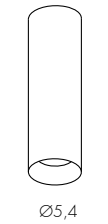

3018DOFBV

1x GU10 max 7W LED - 220V

70,00 €

Configura

Configure / Konfigurieren

www.teamitaliailluminazione.it

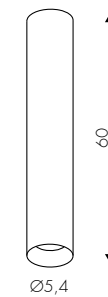

3018EOFBV

1x GU10 max 7W LED - 220V

96,00 €

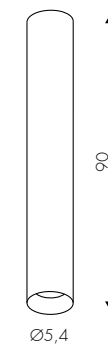

3018FOFBV

1x GU10 max 7W LED - 220V

170,00 €

Configura

Configure / Konfigurieren

www.teamitaliailluminazione.it

NE RV BR OV

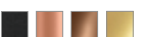

GU10 Sorgente GU10 non inclusa - GU10 light source not included - GU10 Lichtquelle nicht enthalten

CODICE COMPLETO DEL PRODOTTO NELLA FOTO
FULL PRODUCT CODE AS SHOWN IN PICTURE - VOLLSTÄNDIGER CODE VOM ARTIKEL IM BILD

3018EOF

Codice
Code

OV

Finitura
Finishing
Lackierung



configurazione standard: / basic configuration: / Standard Konfiguration:

E28 Satinato
Frosted - Satiniert BV

● **B** 3000K

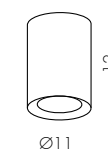

3018ATFBVE28B 17W 1500lm* - 220V **172,00 €**

Configura Configure / Konfigurieren

www.teamitaliailluminazione.it



○ **C** 4000K



configurazione standard: / basic configuration: / Standard Konfiguration:

24° Ottica
Optic - Optik BV

● **B** 3000K

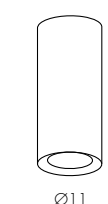

3018BOFBV24B 26W 3400lm - 220V **251,00 €**

3018BDMBV24B DALI (Push) - 26W 3400lm - 220V **308,00 €**

3018BTFBV24B 26W 3400lm - 220V **283,00 €**

Configura Configure / Konfigurieren

www.teamitaliailluminazione.it



○ **C** 4000K



CODICE COMPLETO DEL PRODOTTO NELLA FOTO
FULL PRODUCT CODE AS SHOWN IN PICTURE - VOLLSTÄNDIGER CODE VOM ARTIKEL IM BILD

3018ATF **NE** **E28** **B**

Codice
Code

Finitura
Finishing
Lackierung

Diffusore
Diffuser
Diffusor

Tonalità
Hue
Farbton

TF Taglio di Fase - Phase-Cut Dimmer - Erhältlich Phasenabschnittdimmer

A Alimentatore Incorporato - Incorporated Power Supply - Eingebautes Netzteil

* 1500lm effettivi - effective - effektive con - with - mit **E28**

S-POT

PLAFONE
CEILING LIGHT
DECKENLEUCHTE



configurazione standard: / basic configuration: / Standard Konfiguration:

E2 Opale - Opal

 B 3000K

BV

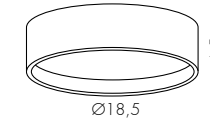

3018GOFBVE2B

26W 2600lm* - 220V

238,00 €

3018GDMBVE2B

DALI (Push) - 26W 2600lm - 220V

295,00 €

3018GTFBVE2B

26W 2600lm - 220V

295,00 €

Configura 

Configure / Konfigurieren

www.teamitaliailluminazione.it 



 **CODICE COMPLETO DEL PRODOTTO NELLA FOTO**
FULL PRODUCT CODE AS SHOWN IN PICTURE - VOLLSTÄNDIGER CODE VOM ARTIKEL IM BILD

3018GOF **BV** **E2** **B**

Codice
Code

Finitura
Finishing
Lackierung

Diffusore
Diffuser
Diffusor

Tonalità
Hue
Farbton

TF Taglio di Fase - Phase-Cut Dimmer - Erhältlich Phasenabschnittdimmer

A Alimentatore Incorporato - Incorporated Power Supply - Eingebautes Netzteil

* 2600lm effettivi - effective - effektive con - with - mit **E2**

 INDEX

 SECTION

 FAMILY 245

TABLET ROUND

PLAFONE
CEILING LIGHT
DECKENLEUCHTE



configurazione standard: / basic configuration: / Standard Konfiguration:

24° Ottica
Optic - Optik

B 3000K

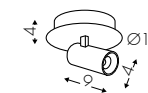

3044POFBV24B 7W 680lm* - 220V

130,00 €

[Configura](#) [Configure / Konfigurieren](#)

www.teamitaliailluminazione.it

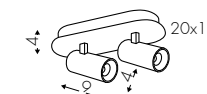

3044QOFBV24B 2x7W 2x680lm - 220V

244,00 €

3044QDMBV24B DALI (Push) 2x7W 2x680lm - 220V

280,00 €

3044QTFBV24B 2x7W 2x680lm - 220V

251,00 €

[Configura](#) [Configure / Konfigurieren](#)

www.teamitaliailluminazione.it

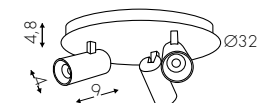

3044GOFBV24B 3x7W 3x680lm - 220V

368,00 €

3044GDMBV24B DALI (Push) 3x7W 3x680lm - 220V

407,00 €

[Configura](#) [Configure / Konfigurieren](#)

www.teamitaliailluminazione.it



C 4000K



TF Taglio di Fase - Phase-Cut Dimmer - Erhältlich Phasenabschrittdimmer

A Alimentatore Incorporato - Incorporated Power Supply - Eingebautes Netzteil

* 680lm effettivi - effective - effektive con - with - mit 24°



TABLET ROUND

PLAFONE
CEILING LIGHT
DECKENLEUCHTE



configurazione standard: / basic configuration: / Standard Konfiguration:

+ E2 Opale - Opal
24° Ottica - Optic - Optik

B 3000K

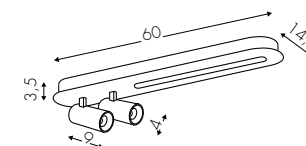

3044SOFBV24B	25W 2860lm + 2x7W 2x680lm* - 220V	353,00 €
3044SDMBV24B	DALI (Push) - 25W 2860lm + 2x7W 2x680lm - 220V	420,00 €
3044STFBV24B	25W 2860lm + 2x7W 2x680lm - 220V	381,00 €

Configura Configure / Konfigurieren

www.teamitaliailluminazione.it



C 4000K



CODICE COMPLETO DEL PRODOTTO NELLA FOTO
FULL PRODUCT CODE AS SHOWN IN PICTURE - VOLLSTÄNDIGER CODE VOM ARTIKEL IM BILD

3044SOF **NE** **24** **B**

Codice
Code

Finitura
Finishing
Lackierung

Diffusore
Diffuser
Diffusor

Tonalità
Hue
Farbton

TF Taglio di Fase - Phase-Cut Dimmer - Erhältlich Phasenabschrittdimmer

A Alimentatore Incorporato - Incorporated Power Supply - Eingebautes Netzteil

* 680lm effettivi - effective - effektive con - with - mit **24**



TABLET ROUND

PLAFONE
CEILING LIGHT
DECKENLEUCHTE



configurazione standard: / basic configuration: / Standard Konfiguration:

BV

GU10

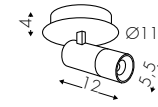

3044TBV

GU10 max 7W LED - 220V

92,00 €

Configura

Configure / Konfigurieren

www.teamitaliailluminazione.it

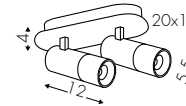

3044UBV

2xGU10 max 7W LED - 220V

174,00 €

Configura

Configure / Konfigurieren

www.teamitaliailluminazione.it

NE



GU10 Sorgente non inclusa - Not included light source - Lichtquelle nicht enthalten





ON custom finish

TABLET SQUARE

PLAFONE
CEILING LIGHT
DECKENLEUCHTE



configurazione standard: / basic configuration: / Standard Konfiguration:

24° Ottica
Optic - Optik

B 3000K

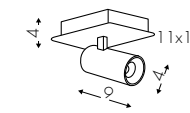

3044MOFBV24B 7W 680lm* - 220V

130,00 €

Configura Configura / Konfigurieren

www.teamitaliailluminazione.it

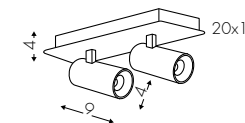

3044NOFBV24B 2x7W 2x680lm - 220V
3044NDMBV24B DALI (Push) 2x7W 2x680lm - 220V
3044NTFBV24B 2x7W 2x680lm - 220V

244,00 €

280,00 €

251,00 €

Configura Configura / Konfigurieren

www.teamitaliailluminazione.it

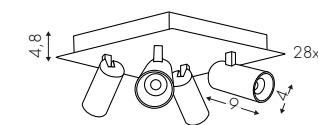

3044FOFBV24B 4x7W 4x680lm - 220V
3044FDMBV24B DALI (Push) - 4x7W 4x680lm - 220V

401,00 €

445,00 €

Configura Configura / Konfigurieren

www.teamitaliailluminazione.it



C 4000K



CODICE COMPLETO DEL PRODOTTO NELLA FOTO
FULL PRODUCT CODE AS SHOWN IN PICTURE - VOLLSTÄNDIGER CODE VOM ARTIKEL IM BILD

3044FOF **ON** **24** **B**

Codice
Code

Finitura
Finishing
Lackierung

Diffusore
Diffuser
Diffusor

Tonalità
Hue
Farbton

TF Taglio di Fase - Phase-Cut Dimmer - Erhältlich Phasenabschnittdimmer

A Alimentatore Incorporato - Incorporated Power Supply - Eingebautes Netzteil

* 680lm effettivi - effective - effektive con - with - mit 24°

TABLET SQUARE

PLAFONE
CEILING LIGHT
DECKENLEUCHE



configurazione standard: / basic configuration: / Standard Konfiguration:

GU10

BV

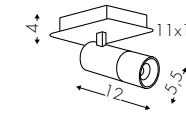

3044OBV

GU10 max 7W LED - 220V

92,00 €

Configura

Configure / Konfigurieren

www.teamitaliailluminazione.it

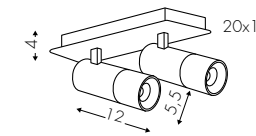

3044VBV

2xGU10 max 7W LED - 220V

174,00 €

Configura

Configure / Konfigurieren

www.teamitaliailluminazione.it

NE



GU10 Sorgente non inclusa - Not included light source - Lichtquelle nicht enthalten

CODICE COMPLETO DEL PRODOTTO NELLA FOTO
FULL PRODUCT CODE AS SHOWN IN PICTURE - VOLLSTÄNDIGER CODE VOM ARTIKEL IM BILD

30440

Codice
Code

NE

Finitura
Finishing
Lackierung



INDEX

SECTION

FAMILY 255



configurazione standard: / basic configuration: / Standard Konfiguration:

38° Offica
Optic - Optik

● B 3000K

BV

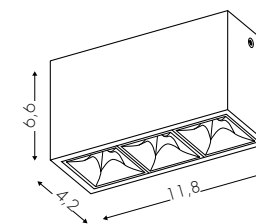

3048COFBV38B 10W 960lm* - 220V

125,00 €

Configura Configura / Konfigurieren

www.teamitaliailluminazione.it

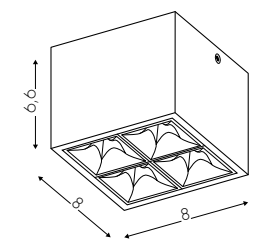

3048DOFBV38B 12W - 1200lm - 220V

163,00 €

Configura Configura / Konfigurieren

www.teamitaliailluminazione.it



NE

A Alimentatore Incorporato - Incorporated power supply - Eingebautes Netzteil

* 960lm effettivi - effective - effektive con - with - mit **38°**



CODICE COMPLETO DEL PRODOTTO NELLA FOTO
FULL PRODUCT CODE AS SHOWN IN PICTURE - VOLLSTÄNDIGER CODE VOM ARTIKEL IM BILD

3048COF **BV** **38** **B**

Codice
Code

Finitura
Finishing
Lackierung

Diffusore
Diffuser
Diffusor

Tonalità
Hue
Farbton





configurazione standard: / basic configuration: / Standard Konfiguration:

E28 Satinato
Frosted - Satiniert ● B 3000K BV

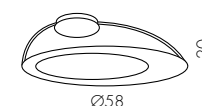

3038AOFBVE28B 25W 3700lm* - 220V **644,00 €**
3038ADMBVE28B DALI (Push) - 25W 3700lm - 220V **692,00 €**
3038ATFBVE28B 25W 3700lm - 220V **692,00 €**

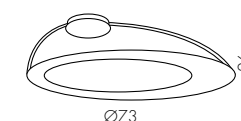

3038BOFBVE28B 50W 6400lm - 220V **752,00 €**
3038BDMBVE28B DALI (Push) - 50W 6400lm - 220V **836,00 €**
3038BTFBVE28B 50W 6400lm - 220V **836,00 €**

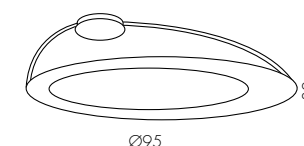

3038COFBVE28B 75W 7800lm - 220V **860,00 €**
3038CDMBVE28B DALI (Push) - 75W 7800lm - 220V **948,00 €**
3038CBTVE28B Bluetooth 75W 7800lm - 220V **948,00 €**

Configura Configura / Konfigurieren

www.teamitaliailluminazione.it



● A 2700K



CODICE COMPLETO DEL PRODOTTO NELLA FOTO
FULL PRODUCT CODE AS SHOWN IN PICTURE - VOLLSTÄNDIGER CODE VOM ARTIKEL IM BILD

3038COF **BV** **E28** **B**

Codice Code	Finitura Finishing Lackierung	Diffusore Diffuser Diffusor	Tonalità Hue Farbton
----------------	-------------------------------------	-----------------------------------	----------------------------

TF Taglio di Fase - Phase-Cut Dimmer - Phasenabschnittdimmer
A Alimentatore Incorporato - Incorporated Power Supply - Eingebautes Netzteil
BT Bluetooth - Bluetooth - Bluetooth

* 3700lm effettivi - effective - effektive con - with - mit **E28**





PIANTANA
FLOOR LAMP
STEHLAMPE





Curve 265
laterale H185



Riflessa 277
laterale H180



Riflessa 277
laterale H180 + spotlight



Edge 267
downlight H204xL92



Edge 267
downlight/uplight H204xL92



Edge 267
2x downlight H204xL152



Edge 267
2x downlight/uplight H204xL152



Lambda 269
uplight H195



Lambda 271
downlight H195x82



Lambda 273
downlight H195x190



Overlap 275
orientabile H185



CURVE

PIANTANA
FLOOR LAMP
STEHLAMP 

configurazione standard: / basic configuration: / Standard Konfiguration:

E2 Opale - Opal

 B 3000K

BV



5022MDMBVE2B

DIM (Push) - 62W 5100lm* - 220V

726,00 €

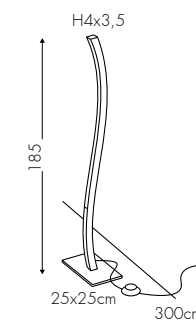

Configura 

Configure / Konfigurieren

www.teamitaliailluminazione.it 



 A 2700K

NE RU 

 Alimentatore Incorporato - Incorporated Power Supply - Eingebautes Netzteil

* 5100lm effettivi - effective - effektive con - with - mit E2

 CODICE COMPLETO DEL PRODOTTO NELLA FOTO
FULL PRODUCT CODE AS SHOWN IN PICTURE - VOLLSTÄNDIGER CODE VOM ARTIKEL IM BILD

5022MDM **NE** **E2** **B**

Codice
Code

Finitura
Finishing
Lackierung

Diffusore
Diffuser
Diffusor

Tonalità
Hue
Farbton



EDGE

PIANTANA
FLOOR LAMP
STEHLAMP 

configurazione standard: / basic configuration: / Standard Konfiguration:

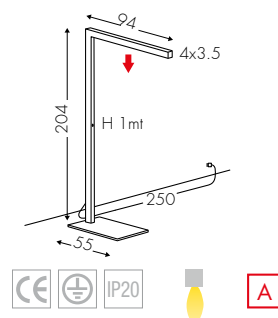

E19 UGR<19 Prism

B 3000K

BV

5028BDMBVE19B

DIM (Push) - 51W 4400lm* - 220V

925,00 €

Configura 

Configure / Konfigurieren

www.teamitaliailluminazione.it 

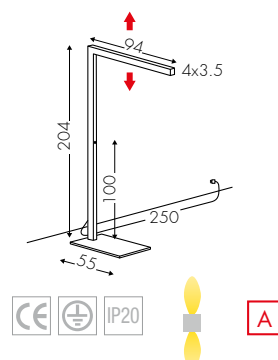

5028CDMBVE19B

DIM (Push) - down 51W 4400lm - up 20W 2200lm - 220V

955,00 €

Configura 

Configure / Konfigurieren

www.teamitaliailluminazione.it 

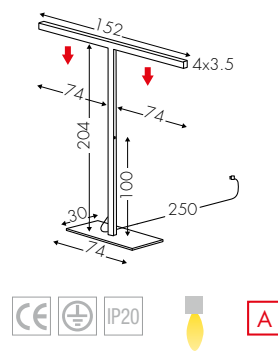

5028DDMBVE19B

DIM (Push) - down 2x32W 2x3500lm

1.530,00 €

Configura 

Configure / Konfigurieren

www.teamitaliailluminazione.it 

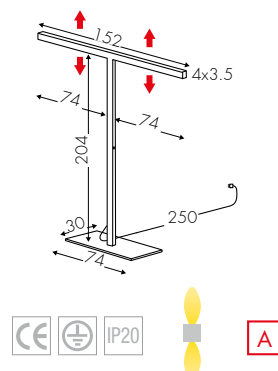

5028EDMBVE19B

DIM (Push) - down 2x32W 2x3500lm - up 2x12W 2x1200lm

1.730,00 €

Configura 

Configure / Konfigurieren

www.teamitaliailluminazione.it 

A 2700K C 4000K

NE RU

A Alimentatore Incorporato - Incorporated Power Supply - Eingebautes Netzteil

* 4400lm effettivi - effective - effektive con - with - mit **E19**

 **CODICE COMPLETO DEL PRODOTTO NELLA FOTO**
FULL PRODUCT CODE AS SHOWN IN PICTURE - VOLLSTÄNDIGER CODE VOM ARTIKEL IM BILD

5028BDM **NE** **E19** **B**

Codice
Code

Finitura
Finishing
Lackierung

Diffusore
Diffuser
Diffusor

Tonalità
Hue
Farbton

LAMBDA

PIANTANA
FLOOR LAMP
STEHLAMP 

configurazione standard: / basic configuration: / Standard Konfiguration:

E2 Opale - Opal  B 3000K 

5071EDPONE2B 35W 3800lm* - 220V

680,00 €

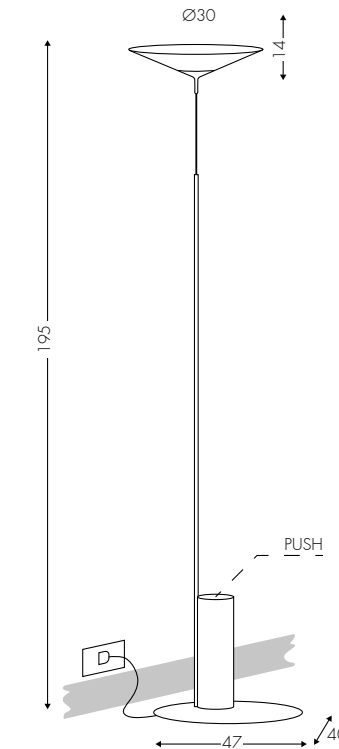

Configura  Configure / Konfigurieren

www.teamitaliailluminazione.it 



 A 2700K



 CODICE COMPLETO DEL PRODOTTO NELLA FOTO
FULL PRODUCT CODE AS SHOWN IN PICTURE - VOLLSTÄNDIGER CODE VOM ARTIKEL IM BILD

5071EDP **ZN** **E2** **B**

Codice
Code

Finitura
Finishing
Lackierung

Diffusore
Diffuser
Diffusor

Tonalità
Hue
Farbton

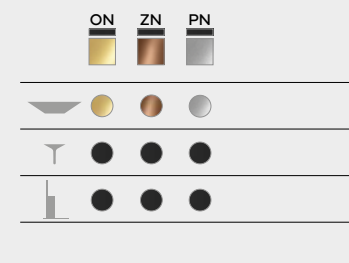

A Alimentatore Incorporato - Incorporated Power Supply - Eingebautes Netzteil
DP Dim Push

* 3800lm effettivi - effective - effektive con - with - mit **E2**

LAMBDA

PIANTANA
FLOOR LAMP
STEHLAMP 

configurazione standard: / basic configuration: / Standard Konfiguration:

E2 Opale - Opal  B 3000K



5071CDPONE2B 9W 1200lm* - 220V

818,00 €

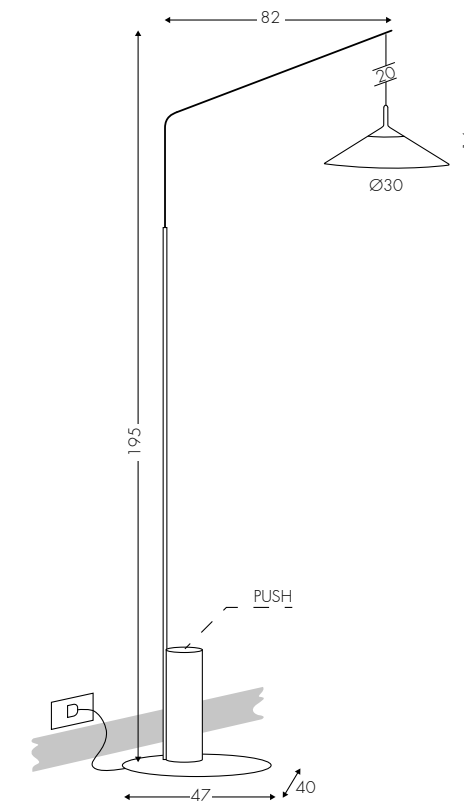

Configura  Configure / Konfigurieren

www.teamitaliailluminazione.it 



 A 2700K



 CODICE COMPLETO DEL PRODOTTO NELLA FOTO
FULL PRODUCT CODE AS SHOWN IN PICTURE - VOLLSTÄNDIGER CODE VOM ARTIKEL IM BILD

5071CDP **ON** **E2** **B**

Codice
Code

Finitura
Finishing
Lackierung

Diffusore
Diffuser
Diffusor

Tonalità
Hue
Farbton

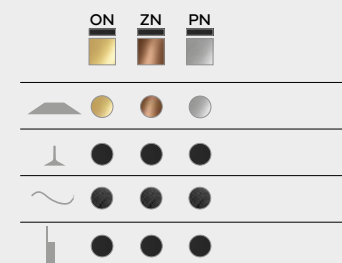

A Alimentatore Incorporato - Incorporated Power Supply - Eingebautes Netzteil
DP Dim Push

* 1200lm effettivi - effective - effektive con - with - mit **E2**



LAMBDA

PIANTANA
FLOOR LAMP
STEHLAMP

configurazione standard: / basic configuration: / Standard Konfiguration:

E2 Opale - Opal B 3000K

5071DDPONE2B 9W 1200lm* - 220V

1.070,00 €

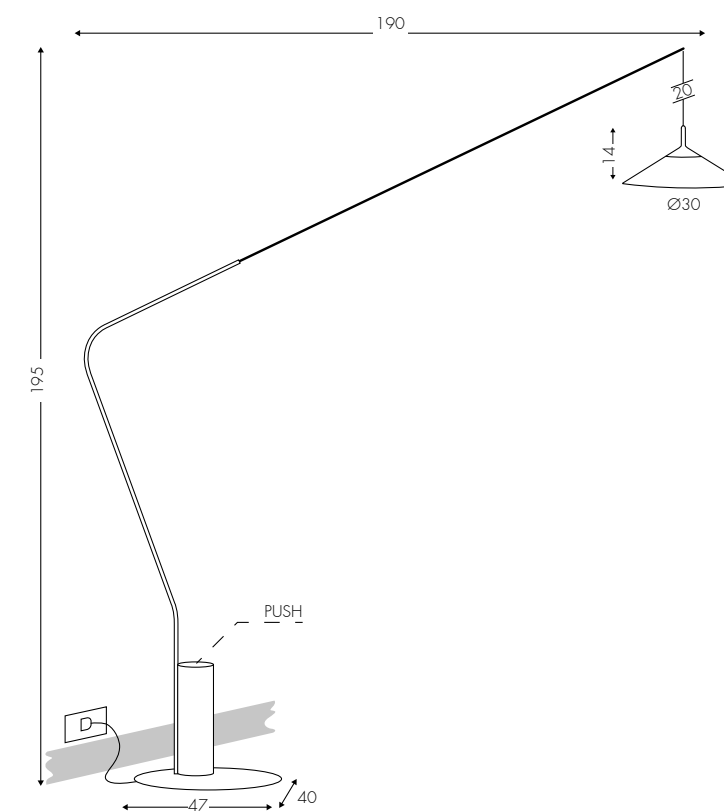

Configura Configure / Konfigurieren

www.teamitaliailluminazione.it

A 2700K

CODICE COMPLETO DEL PRODOTTO NELLA FOTO
FULL PRODUCT CODE AS SHOWN IN PICTURE - VOLLSTÄNDIGER CODE VOM ARTIKEL IM BILD

5071DDP **PN** **E2** **B**

Codice
Code

Finitura
Finishing
Lackierung

Diffusore
Diffuser
Diffusor

Tonalità
Hue
Farbton

Alimentatore Incorporato - Incorporated Power Supply - Eingebautes Netzteil
 Dim Push

* 1200lm effettivi - effective - effektive con - with - mit **E2**

OVERLAP

PIANTANA
FLOOR LAMP
STEHLAMP 

configurazione standard: / basic configuration: / Standard Konfiguration:

E2 Opale - Opal

 B 3000K

BV



5015AOFBVE2B

52W 3645lm* - 220V

526,00 €

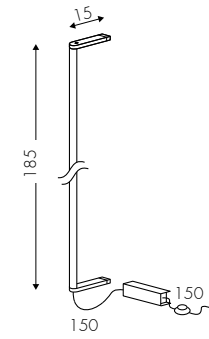

5015ADMBVE2B

DIM (RF) - 52W 3645lm - 220V

668,00 €

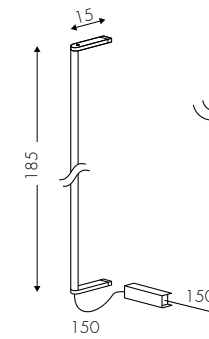

 C005T2BV

Custom white cable

8,00 € /MT

 C005T2RO

Custom red cable

8,00 € /MT

Configura 

Configure / Konfigurieren

www.teamitaliailluminazione.it 



A

 A 2700K

BV



 CODICE COMPLETO DEL PRODOTTO NELLA FOTO
FULL PRODUCT CODE AS SHOWN IN PICTURE - VOLLSTÄNDIGER CODE VOM ARTIKEL IM BILD

5015ADM **BV** **E2** **B** + **C005T2RO**

Codice
Code

Finitura
Finishing
Lackierung

Diffusore
Diffuser
Diffusor

Tonalità
Hue
Farbton

Codice
Code

custom RED CABLE

BV

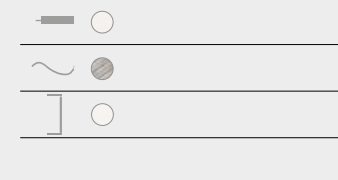

A Alimentatore nel rosone - Power Supply inside the ceiling rose - Netzteil in der Deckendose

* 3645lm effettivi - effective - effektive con - with - mit E2

 INDEX

 SECTION

 FAMILY 275

RIFLESSA

PIANTANA
FLOOR LAMP
STEHLAMP 



configurazione standard: / basic configuration: / Standard Konfiguration:

E28 Satinato
Frosted - Satinert

B 3000K

BV 

5052ADMBVE28B DIM (Push) - 37W 4500lm* - 220V

837,00 €

5052ABTBVE28B Bluetooth 37W 4500lm - 220V

948,00 €

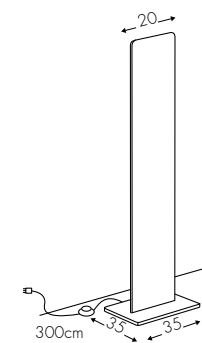

Configura 

Configure / Konfigurieren

www.teamitaliailluminazione.it 



A 2700K



configurazione standard: / basic configuration: / Standard Konfiguration:

E28 Satinato - Frosted - Satinert
24° Ottica - Optic - Optik

B 3000K

BV 

5054ADMBVE28B DIM (Push) - 37W 4500lm + 1x13W 1x1300lm - 220V

948,00 €

5054ABTBVE28B Bluetooth 37W 4500lm + 1x13W 1x1300lm - 220V

1.059,00 €

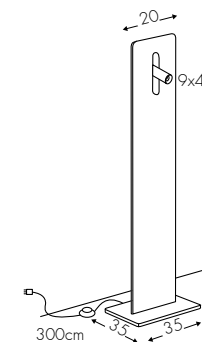

Configura 

Configure / Konfigurieren

www.teamitaliailluminazione.it 



A 2700K

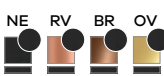

CODICE COMPLETO DEL PRODOTTO NELLA FOTO
FULL PRODUCT CODE AS SHOWN IN PICTURE - VOLLSTÄNDIGER CODE VOM ARTIKEL IM BILD

5054ADM **OV** **E28** **B**

Codice
Code

Finitura
Finishing
Lackierung

Diffusore
Diffuser
Diffusor

Tonalità
Hue
Farbton

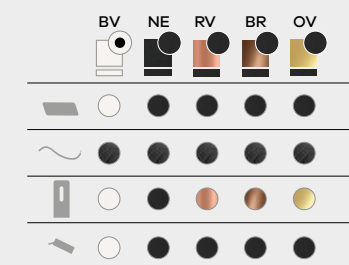

A Alimentatore Incorporato - Incorporated Power Supply - Eingebautes Netzteil

BT Bluetooth - Bluetooth - Bluetooth

* 4500lm effettivi - effective - effektive con - with - mit **E28**

 INDEX

 SECTION

 FAMILY 277

Incassi/recessed Einbauleuchte





Bellai Home 285
downlight cartongesso Ø58/Ø95



Operà 297
orientabile cartongesso - 1x7W



Operà 297
orientabile cartongesso - 2x7W



Operà 297
orientabile cartongesso - 3x7W



Operà 299
orientabile cartongesso - 2x7W +25W



Operà 299
orientabile cartongesso - 2x7W +25W



Retrò 301
downlight cartongesso L23/L37/L65



Micro 295
orientabile cartongesso Ø10 - 1x3W



Micro 295
orientabile cartongesso Ø10 - 2x3W



S-Pot 311
downlight cartongesso/muratura Ø12,5 - 13W



Side 303
downlight cartongesso 9,5x9,5 - 13W



Side 303
downlight cartongesso Ø9 - 13W



S-Pot 307
downlight cartongesso 8x8 - 9W



S-Pot 305
downlight cartongesso Ø9 - 9W



S-Pot 305
downlight cartongesso Ø15 - 18W /26W



Expo 289
downlight cartongesso Ø14 18W/Ø20 36W



S-Pot 313
downlight cartongesso Ø4 - 4W



S-Pot 313
downlight cartongesso Ø6 - 9W



S-Pot 313
downlight cartongesso Ø7 - 13,5W



S-Pot 309
downlight cartongesso Ø5 - 7W



Tablet Round 314
orientabile cartongesso 1x7W GU10



Tablet Round 314
orientabile cartongesso 2x7W GU10



Tablet Round 315
orientabile cartongesso 1x7W



Tablet Round 315
orientabile cartongesso 2x7W



Tablet Round 315
orientabile cartongesso 1x13W



Tablet Square 316
orientabile cartongesso 1x7W GU10

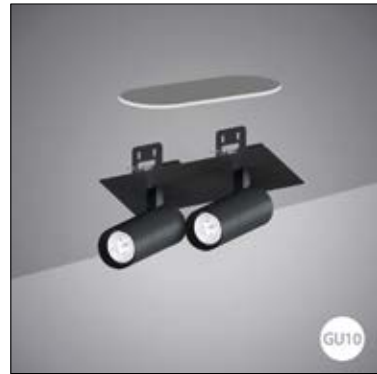

Tablet Square 316
orientabile cartongesso 2x7W GU10

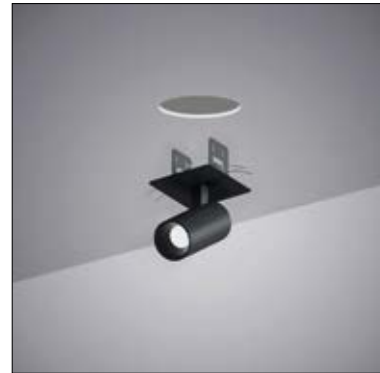

Tablet Square 317
orientabile cartongesso 1x7W

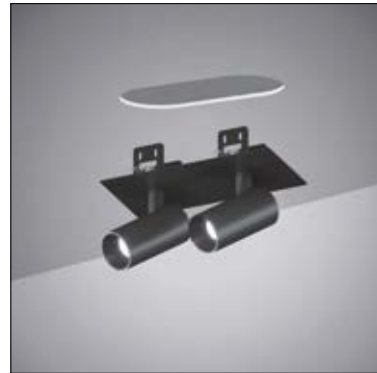

Tablet Square 317
orientabile cartongesso 2x7W



Tablet Square 317
orientabile cartongesso 1x13W



Task 319
downlight cartongesso L4,5x4,5 - 4W

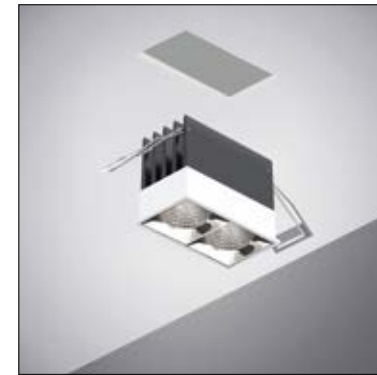

Task 319
downlight cartongesso L4,5x8 - 7,5W



Task 319
downlight cartongesso L4,5x11,5 - 15W

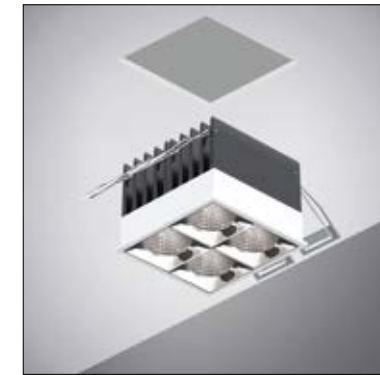

Task 319
downlight cartongesso L8x8 - 18W



Bulbe 287
downlight Ø15/Ø20 versione singola



Lambda 291
downlight versione singola incasso Ø20/Ø30



Venis 323
downlight Ø20 incasso



Licis 293
downlight Ø20 incasso



Tubico 321
downlight versione singola incasso 1x



Tubico 321
downlight composizione incasso 2x



configurazione standard: / basic configuration: / Standard Konfiguration:

E2 Opale - Opal - Opal ● B 3000K

BV

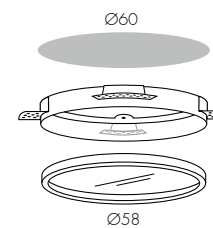

4027EOFBVE2B	45W 3230lm* - 220V	897,00 €
4027EDMBVE2B	DALI (Push) - 45W 3230lm - 220V	981,00 €
4027ETFBVE2B	45W 3230lm - 220V	981,00 €

Configura Configura / Konfigurieren

www.teamitaliailluminazione.it

NE RU

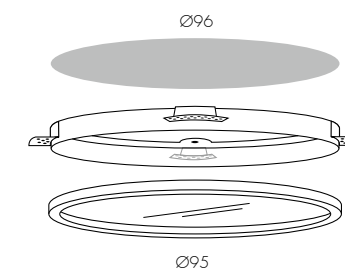

4027FOFBVE2B	65W 5168lm - 220V	1.230,00 €
4027FDMBVE2B	DALI (Push) - 65W 5168lm - 220V	1.315,00 €
4027FBTBVE2B	Bluetooth 65W 5168lm - 220V	1.315,00 €

Configura Configura / Konfigurieren

www.teamitaliailluminazione.it

NE RU



● A 2700K

CODICE COMPLETO DEL PRODOTTO NELLA FOTO
FULL PRODUCT CODE AS SHOWN IN PICTURE - VOLLSTÄNDIGER CODE VOM ARTIKEL IM BILD

4027EOF **BV** **E2** **B**

Codice
Code

Finitura
Finishing
Lackierung

Diffusore
Diffuser
Diffusor

Tonalità
Hue
Farbton

BT Bluetooth - Bluetooth - Bluetooth

A Alimentatore Incorporato - Incorporated Power Supply - Eingebautes Netzteil

* 3230lm effettivi - effective - effektive con - with - mit **E2**





BULBE

INCASSO
RECESSED LIGHT
EINBAULEUCHTE



configurazione standard: / basic configuration: / Standard Konfiguration:

GU10



4078AOB

1x GU10 max 7W LED - 220V

240,00 €

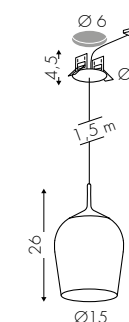

4078BOB

1x GU10 max 7W LED - 220V

275,00 €

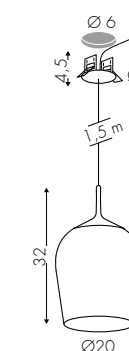

Configura

Configure / Konfigurieren

www.teamitaliailluminazione.it



CODICE COMPLETO DEL PRODOTTO NELLA FOTO
FULL PRODUCT CODE AS SHOWN IN PICTURE - VOLLSTÄNDIGER CODE VOM ARTIKEL IM BILD

4078B

Codice
Code

ZN

Finitura
Finishing
Lackierung

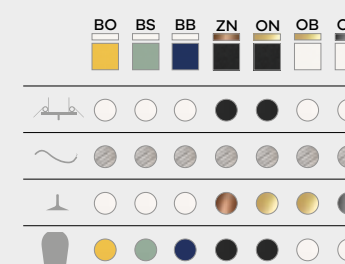

GU10 Sorgente GU10 non inclusa - GU10 light source not included - GU10 Lichtquelle nicht enthalten

INDEX

SECTION

FAMILY 287



configurazione standard: / basic configuration: / Standard Konfiguration:

Ottica 45° (45)

B 3000K

BV

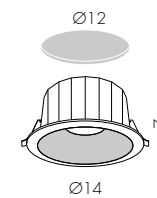

4089BOFBV45B
4089BDMBV45B

18W 1674lm* - 220V
DALI (Push) - 18W 1674lm - 220V

53,00 €
98,00 €

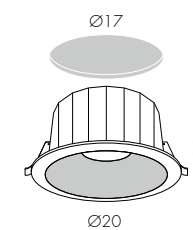

4089COFBV45B
4089CDMBV45B

36W 2800lm - 220V
DALI (Push) - 36W 2800lm - 220V

99,00 €
144,00 €

Configura

Configure / Konfigurieren

www.teamitaliailluminazione.it



C 4000K

BV



Alimentatore incluso in remoto - Included Power Supply in remote - Fernspeisung enthalten

* 1674lm effettivi - effective - effektive con - with - mit E2

CODICE COMPLETO DEL PRODOTTO NELLA FOTO
FULL PRODUCT CODE AS SHOWN IN PICTURE - VOLLSTÄNDIGER CODE VOM ARTIKEL IM BILD

4089COF **BV** **45** **B**

Codice
Code

Finitura
Finishing
Lackierung

Diffusore
Diffuser
Diffusor

Tonalità
Hue
Farbton



LAMBDA

INCASSO
RECESSED LIGHT
EINBAULEUCHTE



configurazione standard: / basic configuration: / Standard Konfiguration:

E19 Prismatico - Prism ● B 3000K



4071PTFONE19B 6,5W 800lm* - 220V

306,00 €

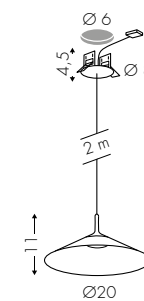

4071QTFONE19B 6,5W 800lm - 220V

386,00 €

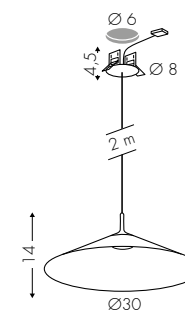

C005A2TR Custom transparent cable

7,00 € /MT

Configura Configure / Konfigurieren

www.teamitaliailluminazione.it



● A 2700K



CODICE COMPLETO DEL PRODOTTO NELLA FOTO
FULL PRODUCT CODE AS SHOWN IN PICTURE - VOLLSTÄNDIGER CODE VOM ARTIKEL IM BILD

4071PTF **ZN** **E19** **A**

Codice Code	Finitura Finishing Lackierung	Diffusore Diffuser Diffusor	Tonalità Hue Farbton
----------------	-------------------------------------	-----------------------------------	----------------------------

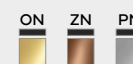

TF Taglio di Fase - Phase-Cut Dimmer - Phasenabschnittdimmer
A↑ Alimentatore incluso in remoto - Included Power Supply in remote - Fernspeisung enthalten

* 800lm effettivi - effective - effektiven con - with - mit **E2**

INDEX

SECTION

FAMILY 291



LICIS

INCASSO
RECESSED LIGHT
EINBAULEUCHTE



configurazione standard: / basic configuration: / Standard Konfiguration:

E2 Opale - Opal - Opal ● B 3000K



4073ATFNTE2B 6,5W 800lm* - 220V

350,00 €

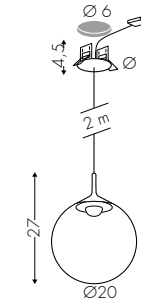

● **C005T2NE** Custom black cable

8,00 € /MT

Configura Configure / Konfigurieren

www.teamitaliailluminazione.it



● A 2700K



CODICE COMPLETO DEL PRODOTTO NELLA FOTO
FULL PRODUCT CODE AS SHOWN IN PICTURE - VOLLSTÄNDIGER CODE VOM ARTIKEL IM BILD

4073ATF **NT** **E2** **A**

Codice Code	Finitura Finishing Lackierung	Diffusore Diffuser Diffusor	Tonalità Hue Farbton
----------------	-------------------------------------	-----------------------------------	----------------------------

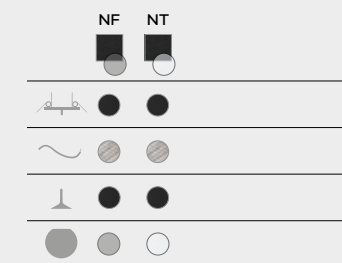

TF Taglio di Fase - Phase-Cut Dimmer - Phasenabschnittdimmer

A↑ Alimentatore incluso in remoto - Included Power Supply in remote - Fernspeisung enthalten

* 800lm effettivi - effective - effektive con - with - mit **E2**

INDEX

SECTION

FAMILY 293



MICRO

INCASSO
RECESSED LIGHT
EINBAULEUCHTE



configurazione standard: / basic configuration: / Standard Konfiguration:

24° Ottica - Optic - Optik ● B 3000K

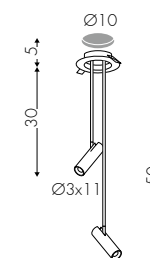
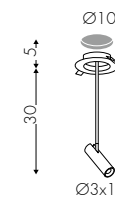

4039ABV24B 3W 360lm* - 350mA - 9V **196,00 €**

Alimentatore - Power supply - Netzteil

AE006A OnOff 10W 350mA / 1-3 art. 4039A **16,00 €**

AE007A DALI (Push) 19,2W 350mA / 1-5 art. 4039A **65,00 €**

AE008D PHASE CUT (Dimmer) 10,5W 350mA / 1-2 art. 4039A **18,00 €**

AE008B PHASE CUT (Dimmer) 18W 350mA / 3-5 art. 4039A **26,00 €**

Configura

Configure / Konfigurieren

www.teamitaliailluminazione.it

4039BBV24B 2x3W 2x360lm - 350mA - 18V **284,00 €**

Alimentatore - Power supply - Netzteil

AE006A OnOff 10W 350mA / 1 art. 4039B **16,00 €**

AE007A DALI (Push) 19,2W 350mA / 1-2 art. 4039B **65,00 €**

AE008A PHASE CUT (Dimmer) 10,5W 350mA / 1 art. 4039B **26,00 €**

AE008B PHASE CUT (Dimmer) 18W 350mA / 2 art. 4039B **26,00 €**

Configura

Configure / Konfigurieren

www.teamitaliailluminazione.it



○ C 4000K



CODICE COMPLETO DEL PRODOTTO NELLA FOTO
FULL PRODUCT CODE AS SHOWN IN PICTURE - VOLLSTÄNDIGER CODE VOM ARTIKEL IM BILD

4039A **NE** **24** **B**

Codice Code	Finitura Finishing Lackierung	Diffusore Diffuser Diffusor	Tonalità Hue Farbton
----------------	-------------------------------------	-----------------------------------	----------------------------

Alimentatore non incluso - Power Supply not included - Netzteil nicht inbegriffen

* 360lm effettivi - effective - effektive con - with - mit 24°



configurazione standard: / basic configuration: / Standard Konfiguration:

24° Ottica - Optic - Optik ● B 3000K

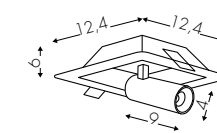

4033AOFBV24B	7W 680lm* - 220V	174,00 €
4033ADMBV24B	DALI (Push) - 7W 680lm - 220V	213,00 €
4033ATFBV24B	7W 680lm - 220V	190,00 €

Configura Configure / Konfigurieren

www.teamitaliailluminazione.it

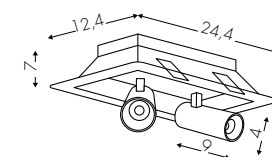

4033BOFBV24B	2x7W 2x680lm - 220V	268,00 €
4033BDMBV24B	DALI (Push) - 2x7W 2x680lm - 220V	308,00 €
4033BTFBV24B	2x7W 2x680lm - 220V	277,00 €

Configura Configure / Konfigurieren

www.teamitaliailluminazione.it

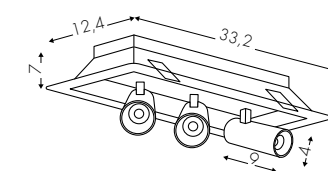

4033COFBV24B	3x7W 3x680lm - 220V	323,00 €
4033CDMBV24B	DALI (Push) - 3x7W 3x680lm - 220V	374,00 €
4033CTFBV24B	3x7W 3x680lm - 220V	359,00 €

Configura Configure / Konfigurieren

www.teamitaliailluminazione.it



C 4000K



TF Taglio di Fase - Phase-Cut Dimmer - Erhältlich Phasenabschnittdimmer

A↑ Alimentatore Incluso in remoto - Included Power Supply in remote - Fernspeisung enthalten

* 680lm effettivi - effective - effektive con - with - mit 24°



CODICE COMPLETO DEL PRODOTTO NELLA FOTO
FULL PRODUCT CODE AS SHOWN IN PICTURE - VOLLSTÄNDIGER CODE VOM ARTIKEL IM BILD

4033BOF ON 24 B

Codice Code	Finitura Finishing Lackierung	Diffusore Diffuser Diffusor	Tonalità Hue Farbton
----------------	-------------------------------------	-----------------------------------	----------------------------





configurazione standard: / basic configuration: / Standard Konfiguration:

+ E2 Opale - Opal
24° Ottica - Optic - Optik ● B 3000K

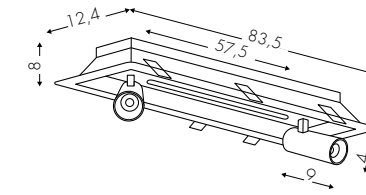

4033EOFBV24B	25W 2860lm* + 2x7W 2x680lm - 220V	347,00 €
4033EDMBV24B	DALI (Push) - 25W 2860lm + 2x7W 2x680lm - 220V	414,00 €
4033ETFBV24B	25W 2860lm + 2x7W 2x680lm - 220V	374,00 €

Configura Configure / Konfigurieren

www.teamitaliailluminazione.it

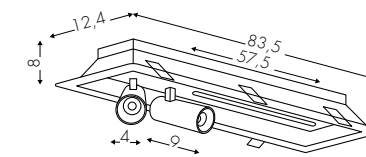

4033FOFBV24B	25W 2860lm + 2x7W 2x680lm - 220V	347,00 €
4033FDMBV24B	DALI (Push) - 25W 2860lm + 2x7W 2x680lm - 220V	414,00 €
4033FTFBV24B	25W 2860lm + 2x7W 2x680lm - 220V	374,00 €

Configura Configure / Konfigurieren

www.teamitaliailluminazione.it



C 4000K



CODICE COMPLETO DEL PRODOTTO NELLA FOTO
FULL PRODUCT CODE AS SHOWN IN PICTURE - VOLLSTÄNDIGER CODE VOM ARTIKEL IM BILD

4033FOF **NE** **24** **B**

Codice
Code

Finitura
Finishing
Lackierung

Diffusore
Diffuser
Diffusor

Tonalità
Hue
Farbton

TF Taglio di Fase - Phase-Cut Dimmer - Erhältlich Phasenabschrittdimmer

A↑ Alimentatore Incluso in remoto - Included Power Supply in remote - Fernspeisung enthalten

* 2860lm effettivi - effective - effektive con - with - mit 24°



RETRO

INCASSO
RECESSED LIGHT
EINBAULEUCHTE



configurazione standard: / basic configuration: / Standard Konfiguration:

E19 UGR<19 Prism

B 3000K

BV

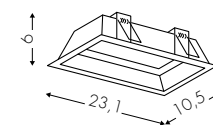

4041GOFBVE19B
4041GDMBVE19B
4041GTFBVE19B

15W - 1800lm* - 220V
DALI(Push) 15W - 1800lm - 220V
(TAGLIO DI FASE) 15W - 1800lm - 220V

186,00 €
223,00 €
223,00 €

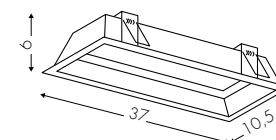

4041HOFBVE19B
4041HDMBVE19B
4041HTFBVE19B

25W - 3300lm - 220V
DALI(Push) 25W - 3300lm - 220V
(TAGLIO DI FASE) 25W - 3300lm - 220V

227,00 €
266,00 €
266,00 €

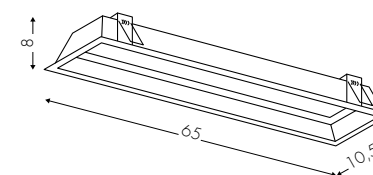

4041IOFBVE19B
4041IDMBVE19B

50W - 6000lm - 220V
DALI(Push) 50W - 6000lm - 220V

290,00 €
340,00 €

Configura

Configure / Konfigurieren

www.teamitaliailluminazione.it



A 2700K C 4000K

NE



CODICE COMPLETO DEL PRODOTTO NELLA FOTO
FULL PRODUCT CODE AS SHOWN IN PICTURE
VOLLSTÄNDIGER CODE VOM ARTIKEL IM BILD

4041GOF **NE** **E19** **B**

Codice
Code

Finitura
Finishing
Lackierung

Diffusore
Diffuser
Diffusor

Tonalità
Hue
Farbton

TF Taglio di Fase - Phase-Cut Dimmer - Phasenabschrittdimmer

A↑ Alimentatore Incluso remoto - Included Power Supply in remote - Fernspeisung enthalten

* 1800lm effettivi - effective - effektive con - with - mit **E19**

SIDE

INCASSO
RECESSED LIGHT
EINBAULEUCHTE



configurazione standard: / basic configuration: / Standard Konfiguration:

24° Ottica - Optic Optik ● B 3000K

BV

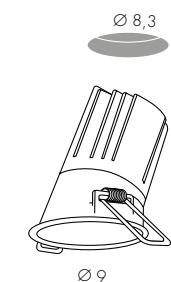
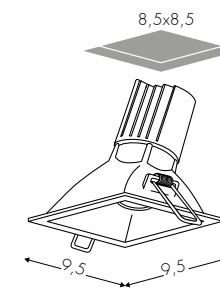

4057ABV24B	13W 1300lm* - 350mA 36V	103,00 €
Alimentatore - Power supply - Netzteil		
AE006B	OnOff 16W 350mA / 1 art. 4057A	28,00 €
AE007A	DALI (Push) 19,2W 350mA / 1 art. 4057A	65,00 €
AE008B	PHASE CUT (Dimmer) 18W 350mA / 1 art. 4057A	26,00 €

Configura Configure / Konfigurieren

www.teamitaliailluminazione.it

4057BBV24B	10W 1300lm - 500mA 20V	103,00 €
Alimentatore - Power supply - Netzteil		
AE006F	OnOff 20W 500mA / 1 art. 4057B	27,00 €
AE007B	DALI (Push) 25W 500mA / 1 art. 4057B	62,00 €
AE008F	PHASE CUT (Dimmer) 20W 500mA / 1 art. 4057B	44,00 €

Configura Configure / Konfigurieren

www.teamitaliailluminazione.it



Alimentatore non incluso - Power supply not included - Netzteil nicht inbegriffen

* 1300lm effettivi - effective - effektive con - with - mit 24°



CODICE COMPLETO DEL PRODOTTO NELLA FOTO
FULL PRODUCT CODE AS SHOWN IN PICTURE
VOLLSTÄNDIGER CODE VOM ARTIKEL IM BILD

4057A **BV** **24** **B**

Codice Code	Finitura Finishing Lackierung	Diffusore Diffuser Diffusor	Tonalità Hue Farbton
----------------	-------------------------------------	-----------------------------------	----------------------------





S-POT

INCASSO
RECESSED LIGHT
EINBAULEUCHE



configurazione standard: / basic configuration: / Standard Konfiguration:

36° Ottica - Optic - Optik ● B 3000K

BV

4017IOFBV36B 9W 1000lm* - 220V 103,00 €
4017ITFBV36B 9W 1000lm - 220V 129,00 €

Configura Configure / Konfigurieren

www.teamitaliailluminazione.it

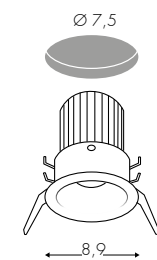

4017LOFBV36B 18W 2000lm - 220V 150,00 €
4017LTFBV36B 18W 2000lm - 220V 177,00 €

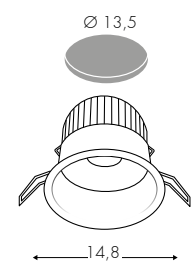

4017MOFBV36B 26W 3000lm - 220V 160,00 €
4017MTFBV36B 26W 3000lm - 220V 187,00 €

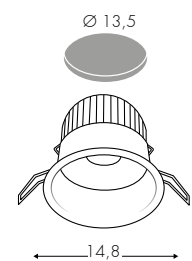

Configura Configure / Konfigurieren

www.teamitaliailluminazione.it



○ C 4000K

NE



CODICE COMPLETO DEL PRODOTTO NELLA FOTO
FULL PRODUCT CODE AS SHOWN IN PICTURE - VOLLSTÄNDIGER CODE VOM ARTIKEL IM BILD

4017LOF **NE** **36** **B**

Codice
Code

Finitura
Finishing
Lackierung

Diffusore
Diffuser
Diffusor

Tonalità
Hue
Farbton

TF Taglio di Fase - Phase-Cut Dimmer - Erhältlich Phasenabschnittdimmer

A↑ Alimentatore Incluso in remoto - Included Power Supply in remote - Fernspeisung enthalten

* 1000lm effettivi - effective - effektive con - with - mit 36°

S-POT

INCASSO
RECESSED LIGHT
EINBAULEUCHTE



configurazione standard: / basic configuration: / Standard Konfiguration:

36° Ottica - Optic - Optik ● B 3000K

BV

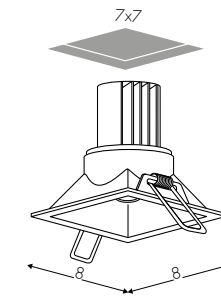

4017NBV36B

Max 9W 1000lm - 350mA 30V

103,00 €

Alimentatore - Power supply - Netzteil

AE006A

OnOff 10W 350mA / 1 art. 4017N

16,00 €

AE007A

DALI (Push) 19,2W 350mA / 1 art. 4017N

65,00 €

AE008D

PHASE CUT (Dimmer) 10W 350mA / 1 art. 4017N

18,00 €

Configura

Configure / Konfigurieren

www.teamitaliailluminazione.it



C 4000K

Alimentatore non incluso - Power Supply not included - Netzteil nicht inbegriffen

* 1000lm effettivi - effective - effektive con - with - mit 36°

CODICE COMPLETO DEL PRODOTTO NELLA FOTO
FULL PRODUCT CODE AS SHOWN IN PICTURE - VOLLSTÄNDIGER CODE VOM ARTIKEL IM BILD

4017N

Codice
Code

BV

Finitura
Finishing
Lackierung

36

Diffusore
Diffuser
Diffusor

B

Tonalità
Hue
Farbton

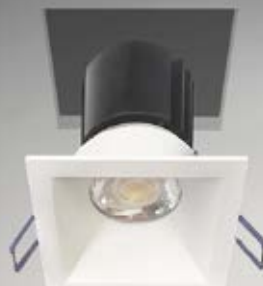

INDEX

SECTION

FAMILY 307



configurazione standard: / basic configuration: / Standard Konfiguration:

24° Ottica - Optic - Optik ● B 3000K

BV

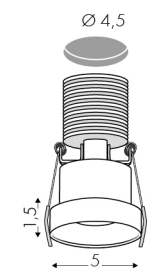

4017SBV24B	Max 7W 680lm* - 350mA 20V	56,00 €
Alimentatore - Power supply - Netzteil		
AE006A	OnOff 10W 350mA / 1 art. 4017S	16,00 €
AE006B	OnOff 16W 350mA / 2 art. 4017S	28,00 €
AE007A	DALI (Push) 19,2W 350mA / 1-2 art. 4017S	65,00 €
AE008A	PHASE CUT (Dimmer) 10W 350mA / 1 art. 4017S	26,00 €
AE008B	PHASE CUT (Dimmer) 18W 350mA / 1-2 art. 4017S	26,00 €



Configura Configure / Konfigurieren

www.teamitaliailluminazione.it



CODICE COMPLETO DEL PRODOTTO NELLA FOTO
FULL PRODUCT CODE AS SHOWN IN PICTURE
VOLLSTÄNDIGER CODE VOM ARTIKEL IM BILD

4017S

OV

24

B

Codice
Code

Finitura
Finishing
Lackierung

Diffusore
Diffuser
Diffusor

Tonalità
Hue
Farbton

Alimentatore non incluso - Power Supply not included - Netzteil nicht inbegriffen

* 680lm effettivi - effective - effektive con - with - mit 24°



S-POT

INCASSO
RECESSED LIGHT
EINBAULEUCHTE



configurazione standard: / basic configuration: / Standard Konfiguration:

E28 Satinato - Satin - Satiniert ● B 3000K

BV



4017TFBVE28B

13W 1300lm* - 220V

185,00 €

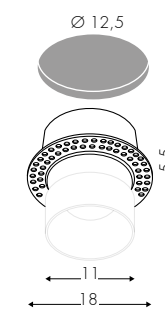
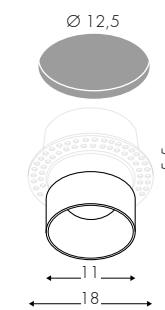

9017F

Controcassa - Outer Casing - Einbauhülse

34,00 €

Configura

Configure / Konfigurieren

www.teamitaliailluminazione.it



C 4000K



CODICE COMPLETO DEL PRODOTTO NELLA FOTO
FULL PRODUCT CODE AS SHOWN IN PICTURE
VOLLSTÄNDIGER CODE VOM ARTIKEL IM BILD

4017TF **OV** **E28** **B** + **9017F**

Codice
Code

Finitura
Finishing
Lackierung

Diffusore
Diffuser
Diffusor

Tonalità
Hue
Farbton

Codice
Code

TF Taglio di Fase - Phase-Cut Dimmer - Erhältlich Phasenabschnittdimmer

A Alimentatore Incorporato - Incorporated Power Supply - Eingebautes Netzteil

* 1300lm effettivi - effective - effektive con - with - mit **E28**

INDEX

SECTION

FAMILY 311

S-POT

INCASSO
RECESSED LIGHT
EINBAULEUCHE



configurazione standard: / basic configuration: / Standard Konfiguration:

24° Ottica - Optic - Optik ● B 3000K

BV

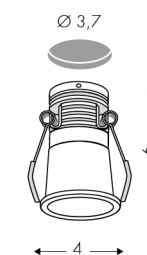

4017TBV24B Max 4W 480lm* - 300mA 10V **50,00 €**

Alimentatore - Power supply - Netzteil

AE008F PHASE CUT (Dimmer) 20W 300mA / 1-4 art. 4017T **44,00 €**

AE007A DALI (Push) 30W 300mA / 1-5 art. 4017T **65,00 €**

[Configura](#) Configure / Konfigurieren

www.teamitaliailluminazione.it

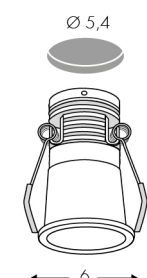

4017UBV24B Max 9W 860lm - 300mA 30V **54,00 €**

Alimentatore - Power supply - Netzteil

AE008G PHASE CUT (Dimmer) 20W 300mA/max 1 art. 4017U **25,00 €**

AE007C DALI (Push) - 20W 300mA/max 1 art. 4017U **55,00 €**

[Configura](#) Configure / Konfigurieren

www.teamitaliailluminazione.it

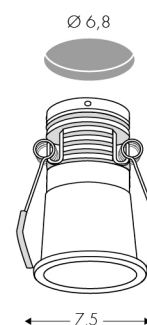

4017VBV24B Max 13,5W 1290lm - 300mA 45V **67,00 €**

Alimentatore - Power supply - Netzteil

AE008H PHASE CUT (Dimmer) - 20W 300mA/max 1 art. 4017V **46,00 €**

AE007F DALI (Push) - 20W 300mA/max 1 art. 4017V **56,00 €**

[Configura](#) Configure / Konfigurieren

www.teamitaliailluminazione.it



NE RV BR OV



Alimentatore non incluso - Power Supply not included - Netzteil nicht inbegriffen

* 480lm effettivi - effective - effektive con - with - mit 24°

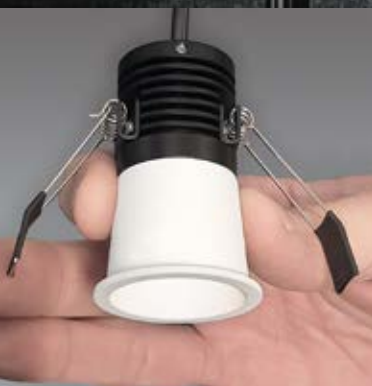

CODICE COMPLETO DEL PRODOTTO NELLA FOTO
FULL PRODUCT CODE AS SHOWN IN PICTURE - VOLLSTÄNDIGER CODE VOM ARTIKEL IM BILD

4017V

Codice
Code

BV

Finitura
Finishing
Lackierung

24

Diffusore
Diffuser
Diffusor

B

Tonalità
Hue
Farbton



configurazione standard: / basic configuration: / Standard Konfiguration:

GU10

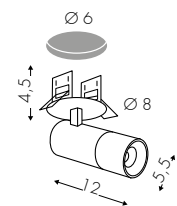

4044DBV

GU10 max 1x7W LED - 220V

82,00 €

Configura Configure / Konfigurieren

www.teamitaliailluminazione.it

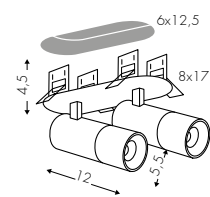

4044EBV

GU10 max 2x7W LED - 220V

163,00 €

Configura Configure / Konfigurieren

www.teamitaliailluminazione.it



GU10 Sorgente non inclusa - Not included light source - Lichtquelle nicht enthalten

CODICE COMPLETO DEL PRODOTTO NELLA FOTO
FULL PRODUCT CODE AS SHOWN IN PICTURE • VOLLSTÄNDIGER CODE VOM ARTIKEL IM BILD

4044E

Codice
Code

NE

Finitura
Finishing
Lackierung



GU10

configurazione standard: / basic configuration: / Standard Konfiguration:

24° Ottica - Optic - Optik B 3000K

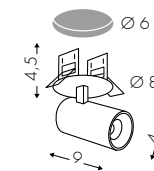

4044PBV24B

7W 680lm* - 350mA 20V

104,00 €

Alimentatore - Power supply - Netzteil

AE006A OnOff 10W 350mA / 1 art. 4044P **16,00 €**

AE006B OnOff 16W 350mA / 2 art. 4044P **28,00 €**

AE007A DALI (Push) 19,2W 350mA / 1-2 art. 4044P **65,00 €**

AE008A PHASE CUT (Dimmer) 10W 350mA / 1 art. 4044P **26,00 €**

AE008B PHASE CUT (Dimmer) 18W 350mA / 2 art. 4044P **26,00 €**

Configura Configure / Konfigurieren

www.teamitaliailluminazione.it

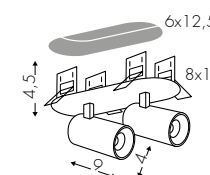

4044QBV24B

2x7W 2x680lm - 350mA 40V

214,00 €

Alimentatore - Power supply - Netzteil

AE006B OnOff 16W 350mA / 1 art. 4044Q **28,00 €**

AE007A DALI (Push) 19,2W 350mA / 1 art. 4044Q **65,00 €**

AE008B PHASE CUT (Dimmer) 18W 350mA / 1 art. 4044Q **26,00 €**

Configura Configure / Konfigurieren

www.teamitaliailluminazione.it

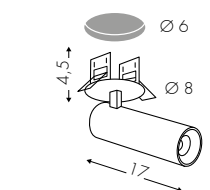

4044UBV24B

13W 1300lm - 350mA 36V

119,00 €

Alimentatore - Power supply - Netzteil

AE006B OnOff 16W 350mA / 1 art. 4044U **28,00 €**

AE007A DALI (Push) 19,2W 350mA / 1 art. 4044U **65,00 €**

AE008B PHASE CUT (Dimmer) 18W 350mA / 1 art. 4044U **26,00 €**

Configura Configure / Konfigurieren

www.teamitaliailluminazione.it



C 4000K



Alimentatore non incluso - Power Supply not included
Netzteil nicht inbegriffen

* 680lm effettivi - effective - effektive con - with - mit 24°

INDEX

SECTION

FAMILY



configurazione standard: / basic configuration: / Standard Konfiguration:

GU10

BV

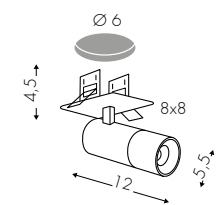

4044ABV

GU10 max 1x7W LED - 220V

82,00 €

Configura Configure / Konfigurieren

www.teamitaliailluminazione.it

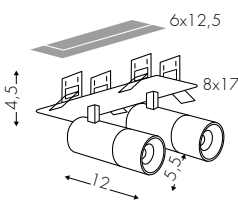

4044BBV

GU10 max 2x7W LED - 220V

163,00 €

Configura Configure / Konfigurieren

www.teamitaliailluminazione.it



NE



GU10 Sorgente non inclusa - Not included light source - Lichtquelle nicht enthalten

CODICE COMPLETO DEL PRODOTTO NELLA FOTO
FULL PRODUCT CODE AS SHOWN IN PICTURE • VOLLSTÄNDIGER CODE VOM ARTIKEL IM BILD

4044B

Codice
Code

NE

Finitura
Finishing
Lackierung

configurazione standard: / basic configuration: / Standard Konfiguration:

24° Ottica - Optic - Optik ● B 3000K

BV

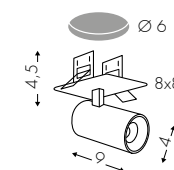

4044MBV24B

7W 680lm* - 350mA 20V

104,00 €

Alimentatore - Power supply - Netzteil

AE006A OnOff 10W 350mA / 1 art. 4044M **16,00 €**

AE006B OnOff 16W 350mA / 2 art. 4044M **28,00 €**

AE007A DALI (Push) 19,2W 350mA / 1-2 art. 4044M **65,00 €**

AE008A PHASE CUT (Dimmer) 10W 350mA / 1 art. 4044M **26,00 €**

AE008B PHASE CUT (Dimmer) 18W 350mA / 2 art. 4044M **26,00 €**

Configura Configure / Konfigurieren

www.teamitaliailluminazione.it

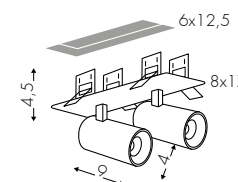

4044NBV24B

2x7W 2x680lm - 350mA 40V

214,00 €

Alimentatore - Power supply - Netzteil

AE006B OnOff 16W 350mA / 1 art. 4044N **28,00 €**

AE007A DALI (Push) 19,2W 350mA / 1 art. 4044N **65,00 €**

AE008B PHASE CUT (Dimmer) 18W 350mA / 1 art. 4044N **26,00 €**

Configura Configure / Konfigurieren

www.teamitaliailluminazione.it

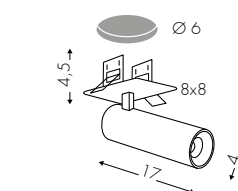

4044RBV24B

13W 1300lm - 350mA 36V

119,00 €

Alimentatore - Power supply - Netzteil

AE006B OnOff 16W 350mA / 1 art. 4044R **28,00 €**

AE007A DALI (Push) 19,2W 350mA / 1 art. 4044R **65,00 €**

AE008B PHASE CUT (Dimmer) 18W 350mA / 1 art. 4044R **26,00 €**

Configura Configure / Konfigurieren

www.teamitaliailluminazione.it



○ C 4000K

NE



Alimentatore non incluso
Power Supply not included - Netzteil nicht inbegriffen

* 680lm effettivi - effective - effektive con - with - mit 24°

INDEX

SECTION

FAMILY





configurazione standard: / basic configuration: / Standard Konfiguration:

24° Ottica - Optic Optik ● B 3000K

BV

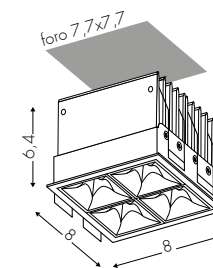
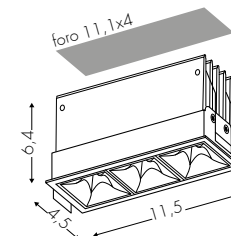
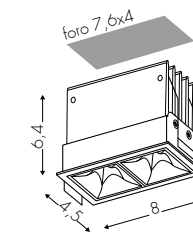
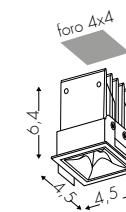

4048ABV24B 4W 400lm* - 150mA 30V **52,00 €**

Alimentatore - Power supply - Netzteil

AE006E OnOff 6W 150mA / 1 art. 4048A **22,00 €**

AE008F PHASE CUT (Dimmer) 20W 150mA / 1 art. 4048A **44,00 €**

Configura Configure / Konfigurieren www.teamitaliailluminazione.it

4048BBV24B 7,5W 900lm - 250mA - 30V **83,00 €**

Alimentatore - Power supply - Netzteil

AE006D OnOff 9W 250mA / 1 art. 4048B **22,00 €**

AE007C DALI (Push) 10W 250mA / 1 art. 4048B **55,00 €**

AE008F PHASE CUT (Dimmer) 20W 250mA / 1 art. 4048B **44,00 €**

Configura Configure / Konfigurieren www.teamitaliailluminazione.it

4048CBV24B 15W 1500lm - 500mA - 36V **125,00 €**

Alimentatore - Power supply - Netzteil

AE006F OnOff 20W 500mA / 1 art. 4048C **27,00 €**

AE007B DALI (Push) 25W 500mA / 1 art. 4048C **62,00 €**

AE008F PHASE CUT (Dimmer) 20W 500mA / 1 art. 4048C **44,00 €**

Configura Configure / Konfigurieren www.teamitaliailluminazione.it

4048DBV24B 18W - 1800lm - 600mA - 30V **163,00 €**

Alimentatore - Power supply - Netzteil

AE006G OnOff 24W 600mA / 1 art. 4048D **35,00 €**

AE007B DALI (Push) 25W 600mA / 1 art. 4048D **62,00 €**

AE008F PHASE CUT (Dimmer) 20W 600mA / 1 art. 4048D **44,00 €**

Configura Configure / Konfigurieren www.teamitaliailluminazione.it



Alimentatore non incluso - Power supply not included - Netzteil nicht inbegriffen

* 400lm effettivi - effective - effektive con - with - mit 24°



CODICE COMPLETO DEL PRODOTTO NELLA FOTO
FULL PRODUCT CODE AS SHOWN IN PICTURE - VOLLSTÄNDIGER CODE VOM ARTIKEL IM BILD

4048D

Codice
Code

BV

Finitura
Finishing
Lackierung

24

Diffusore
Diffuser
Diffusor

B

Tonalità
Hue
Farbton





configurazione standard: / basic configuration: / Standard Konfiguration:

E8 Trasparente - Transparent ● B 3000K



4069IOFONE8B 3W 350lm* - 220V

248,00 €

Configura Configure / Konfigurieren

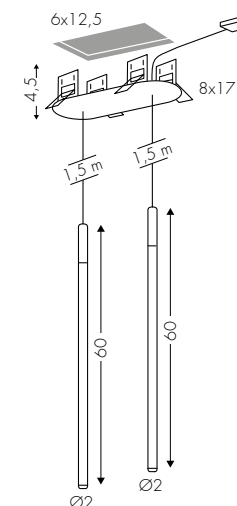
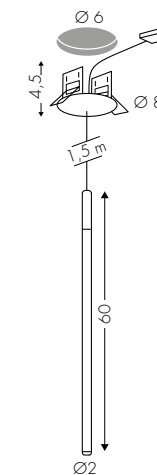

4069UTFONE8B 2x3W 2x350lm - 220V

454,00 €

CO05T2NE Custom black cable

8,00 € /MT

Configura Configure / Konfigurieren

www.teamitaliailluminazione.it



E19 ● A 2700K



CODICE COMPLETO DEL PRODOTTO NELLA FOTO
FULL PRODUCT CODE AS SHOWN IN PICTURE - VOLLSTÄNDIGER CODE VOM ARTIKEL IM BILD

4069IOF **PN** **E8** **B** + **CO05T2NE**

Codice
Code

Finitura
Finishing
Lackierung

Diffusore
Diffuser
Diffusor

Tonalità
Hue
Farbton

Codice
Code

custom BLACK CABLE

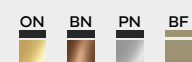

A↑ Alimentatore incluso in remoto - Included Power Supply in remote - Fernspeisung enthalten
TF Taglio di Fase - Phase-Cut Dimmer - Phasenabschrittdimmer

* 350lm effettivi - effective - effektive con - with - mit E8



E8



VENIS

INCASSO
RECESSED LIGHT
EINBAULEUCHTE



configurazione standard: / basic configuration: / Standard Konfiguration:

E2 Opale - Opal - Opal ● B 3000K



4064ATFNTE2B 6,5W 800lm* - 220V

350,00 €

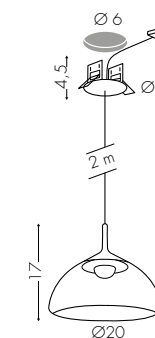

● **C005T2NE** Custom black cable

8,00 € /MT

Configura Configure / Konfigurieren

www.teamitaliailluminazione.it



● **A 2700K**



CODICE COMPLETO DEL PRODOTTO NELLA FOTO
FULL PRODUCT CODE AS SHOWN IN PICTURE - VOLLSTÄNDIGER CODE VOM ARTIKEL IM BILD

1064ATF **NZ** **E2** **A**

Codice Code	Finitura Finishing Lackierung	Diffusore Diffuser Diffusor	Tonalità Hue Farbton
----------------	-------------------------------------	-----------------------------------	----------------------------

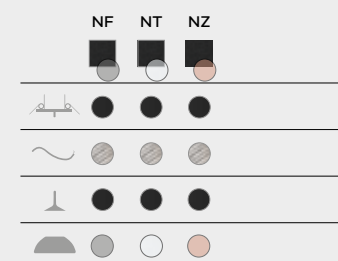

Alimentatore incluso in remoto - Included Power Supply in remote - Fernspeisung enthalten
 Taglio di Fase - Phase-Cut Dimmer - Phasenabschrittdimmer

* 800lm effettivi - effective - effektive con - with - mit **E2**

Profili/Profiles/Profile

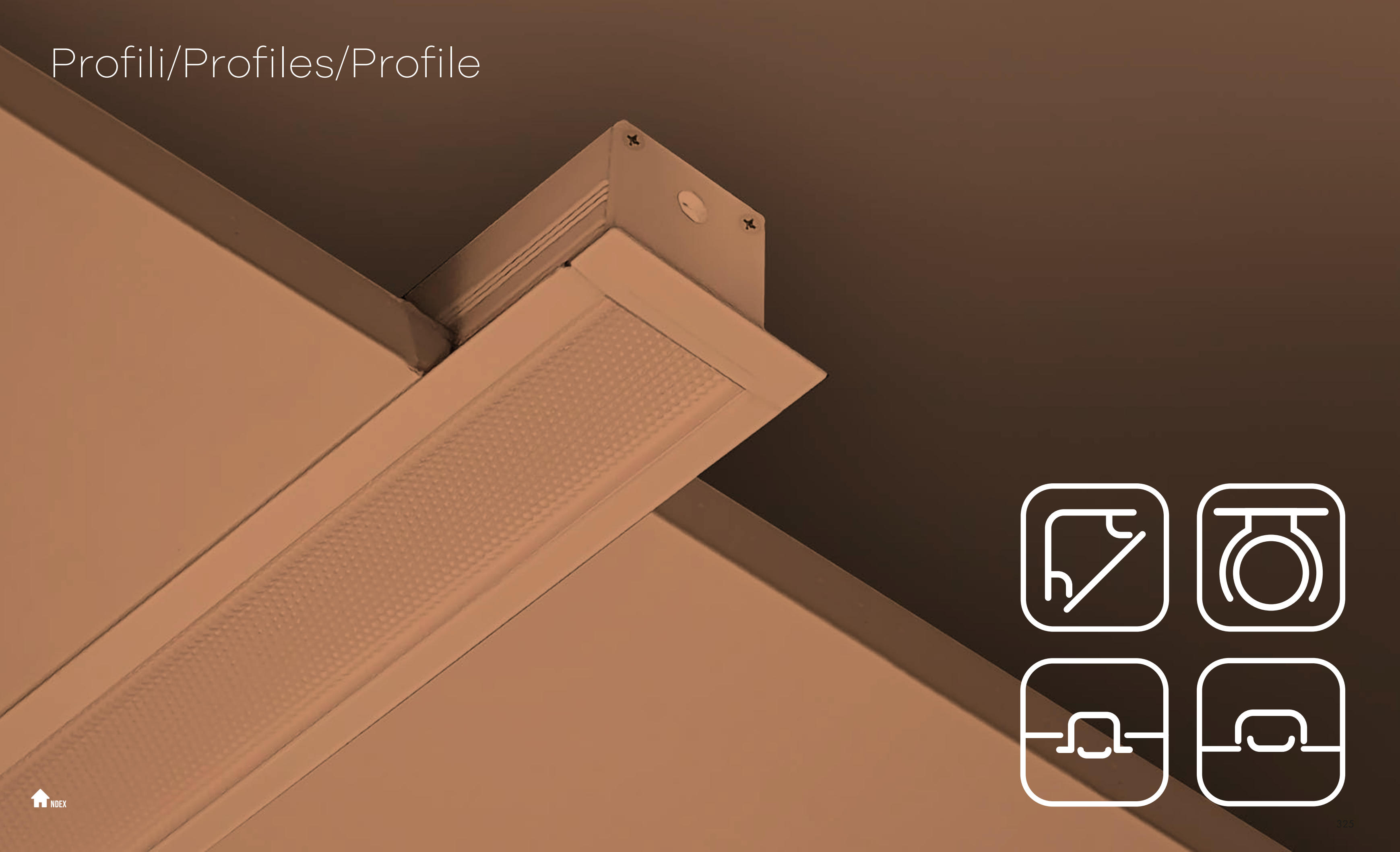

Universali/Universal/Universal



Profili universali 329
orientabile 360° downlight [100-250cm]

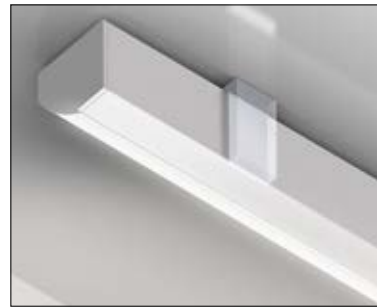

Profili universali 331
angolare [100-250cm]



Profili universali 333
basic [100-300cm]

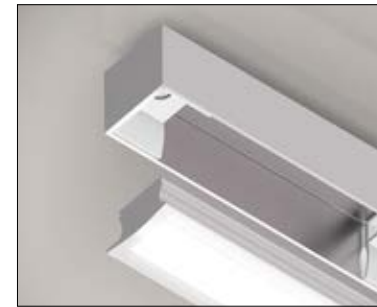

Profili universali 335
plafone S [100-250cm]

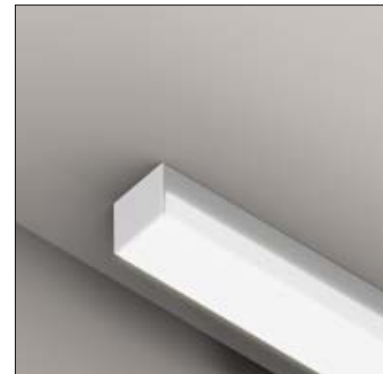

Profili universali 337
profilo multiuso [100-250cm]

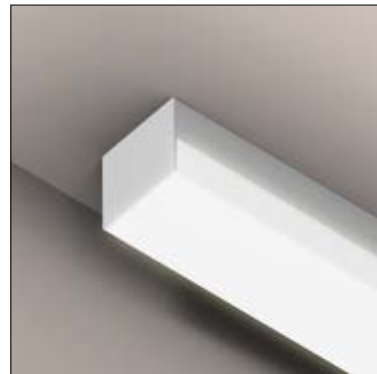

Profili universali 339
profilo multiuso M [100-300cm]

Velette luminose/Wall washing effect/Wall washer-effekt



Velette luminose 341
veletta luminosa O [100-300cm]



Velette luminose 343
veletta luminosa H [100-300cm]

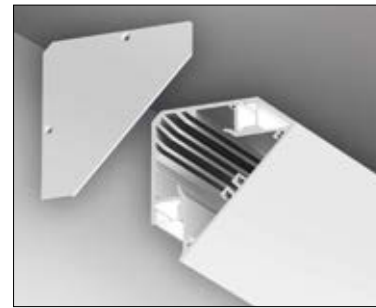

Velette luminose 345
biemissione [100-300cm]

Incasso con cornice/Recessed profile/Einbau profile



Incasso con cornice 347
incasso con cornice [100-250cm]



Incasso con cornice 349
incasso con cornice C [100-250cm]



Incasso con cornice 351
incasso con cornice M [100-250cm]



Incasso con cornice 353
incasso con cornice L [100-250cm]

Incasso filomuro/Recessed wall flush effect/Einbauchte bündig mit der wand



Incasso a raso 355
incasso filomuro I [100-300cm]
Cartongesso ESCLUSO



Incasso a raso 357
incasso filomuro N [100-300cm]
Cartongesso INCLUSO

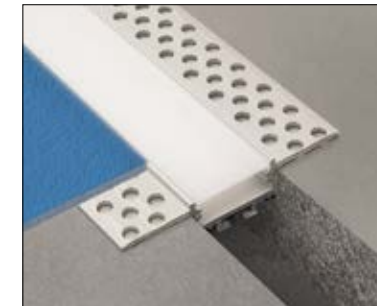

Incasso a raso 359
incasso filomuro F [100-300cm]
Cartongesso ESCLUSO

Complementi/Complements/Ergänzungen



Striped 360



Drivers 362

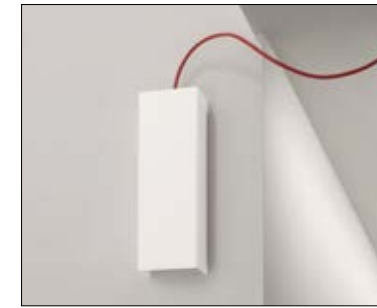

Rosoni / Canopy 363

Sistemi di gestione della luce/Light system management/Lichtsteuersysteme

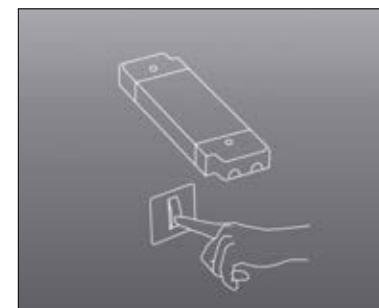

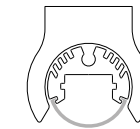

PLC Push Light Control 362
Gestione della luce con pulsante Push

6010 - ORIENTABILE 360°



6010Z0MT1	profile 100 cm (NO LED)	43,00 €	31,00 €
6010Z0MT2	profile 200 cm (NO LED)	86,00 €	61,00 €
6010Z0MT25	profile 250 cm (NO LED)	108,00 €	76,00 €

-  E2 Opale - Opal
-  E28 Satinato - Frosted - Satiniert

-  Led non incluso - Led not included - Led nicht inbegriffen
-  Alimentatore non incluso - Power Supply not included - Netzteil nicht inbegriffen



Accessori inclusi
Accessories included
Einschließlich Zubehör

SERVIZIO SU MISURA



001001A Taglio Profilo - Cut service **10,00 €**

Configura  Configure / Konfigurieren

www.teamitaliailluminazione.it 

CODICE COMPLETO • COMPLETE CODE • VOLLSTÄNDIGE CODE

6010Z0MT25 **BV** **E2** + **001001A**

Codice Code Code	Finitura Finishing Lackierung	Diffusore Diffuser Diffusor	SERVICE
------------------------	-------------------------------------	-----------------------------------	---------

STRIP E ROLLE LED pag. 360-361
DRIVERS & DIMMER
E ROSONI pag. 362-363





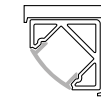

8010 - ANGOLARE



8010ZOMT1	profile 100 cm (NO LED)	41,00 €	30,00 €
8010ZOMT2	profile 200 cm (NO LED)	82,00 €	59,00 €
8010ZOMT25	profile 250 cm (NO LED)	102,00 €	74,00 €

-  E2 Opale - Opal
-  E28 Satinato - Frosted - Satiniert

-  Led non incluso - Led not included - Led nicht inbegriffen
-  Alimentatore non incluso - Power Supply not included - Netzteil nicht inbegriffen



Accessori inclusi
Accessories included
Einschließlich Zubehör

SERVIZIO SU MISURA



001001A Taglio Profilo - Cut service **10,00 €**

[Configura](#)  Configure / Konfigurieren

www.teamitaliailluminazione.it 

CODICE COMPLETO • COMPLETE CODE • VOLLSTÄNDIGE CODE

8010ZOMT25 **BV** **E2** + **001001A**

Code	Finitura	Diffusore	SERVICE
Code	Finishing	Diffuser	
Code	Lackierung	Diffusor	

STRIP E ROLLE LED pag. 360-361
DRIVERS & DIMMER
E ROSONI pag. 362-363







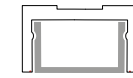

3010F - BASIC



3010FZOMT1	profile 100 cm (NO LED)	34,00 €	25,00 €
3010FZOMT2	profile 200 cm (NO LED)	68,00 €	49,00 €
3010FZOMT3	profile 300 cm (NO LED)	102,00 €	74,00 €

-  E2 Opale - Opal
-  E28 Satinato - Frosted - Satiniert

-  Led non incluso - Led not included - Led nicht inbegriffen
-  Alimentatore non incluso - Power Supply not included - Netzteil nicht inbegriffen

3010FTP	KIT TAPPI PROFILO 3010 F	8,00 €
AE002A	SENSORE TOUCH ON/OFF	52,00 €

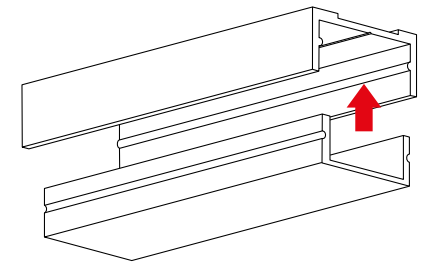
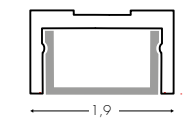

SERVIZIO SU MISURA

001001A	Taglio Profilo - Cut service	10,00 €
----------------	------------------------------	----------------



Configura  Configura / Konfigurieren

www.teamitaliailluminazione.it 

CODICE COMPLETO • COMPLETE CODE • VOLLSTÄNDIGE CODE

3010FZOMT2 **BV** **E2** + **001001A**

Code	Finitura	Diffusore	SERVICE
Code	Finishing	Diffuser	
Code	Lackierung	Diffusor	

STRIP E ROLLE LED pag. 360-361
DRIVERS & DIMMER
E ROSONI pag. 362-363



PROFILI

3010E - PLAFONE S

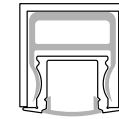

3010EZ0MT1	profile 100 cm (NO LED)	63,00 €	72,00 €
3010EZ0MT2	profile 200 cm (NO LED)	125,00 €	144,00 €
3010EZ0MT25	profile 250 cm (NO LED)	156,00 €	180,00 €

- E2 Opale - Opal
- E28 Satinato - Frosted - Satiniert

- Led non incluso - Led not included - Led nicht inbegriffen
- Alimentatore non incluso - Power Supply not included - Netzteil nicht inbegriffen

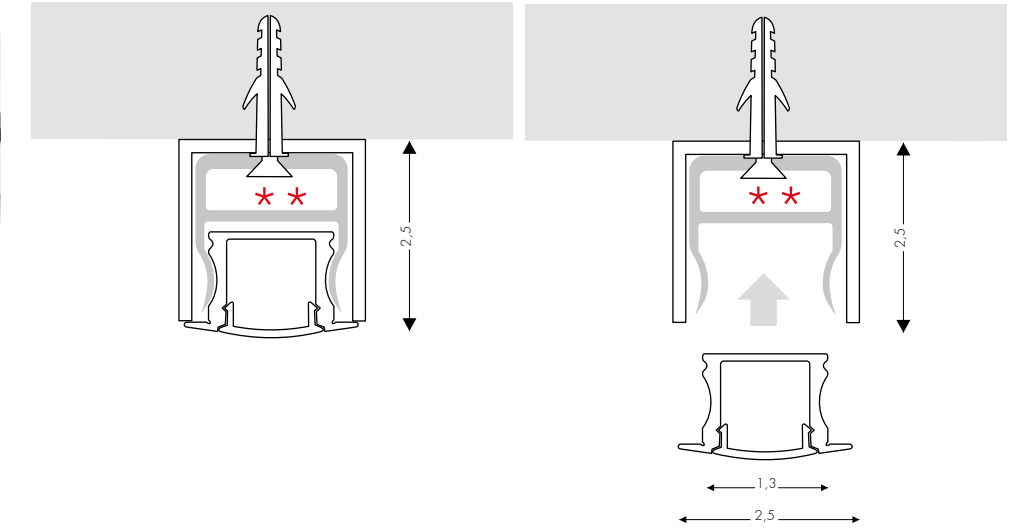

**Possibilità passaggio cavo
Possible cable passage
Eventueller Kabeldurchgang

SERVIZIO SU MISURA



001001A

Taglio Profilo - Cut service

10,00 €

Configura Configure / Konfigurieren

www.teamitaliailluminazione.it

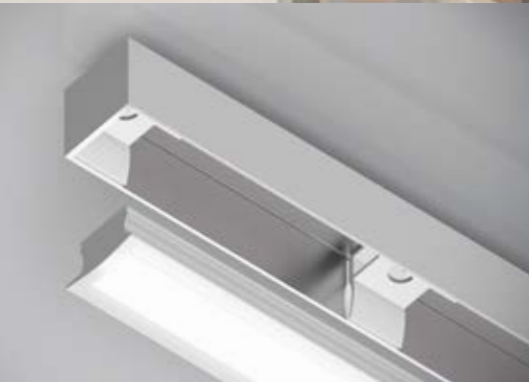

STRIP E ROLLE LED pag. 360-361
DRIVERS & DIMMER
E ROSONI pag. 362-363



3010 - PROFILO MULTIUSO

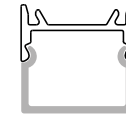

3010ZOMT1	profile 100 cm (NO LED)	46,00 €	31,00 €
3010ZOMT2	profile 200 cm (NO LED)	92,00 €	61,00 €
3010ZOMT25	profile 250 cm (NO LED)	115,00 €	76,00 €

 E2 Opale - Opal

 Led non incluso - Led not included - Led nicht inbegriffen

 Alimentatore non incluso - Power Supply not included - Netzteil nicht inbegriffen



Accessori inclusi
Accessories included
Einschließlich Zubehör

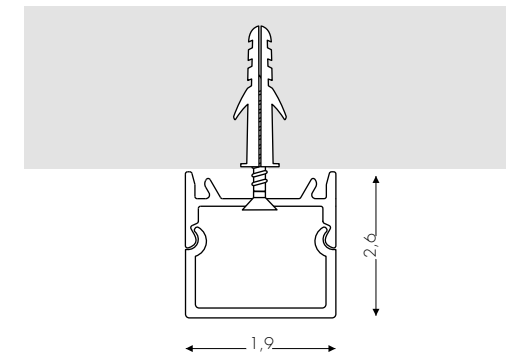

SERVIZIO SU MISURA



001001A

Taglio Profilo - Cut service

10,00 €

Configura  Configure / Konfigurieren

www.teamitaliailluminazione.it 

CODICE COMPLETO • COMPLETE CODE • VOLLSTÄNDIGE CODE

3010ZOMT25 **BV** **E2** + **001001A**

Code	Finitura	Diffusore	SERVICE
Code	Finishing	Diffuser	
Code	Lackierung	Diffusor	

STRIP E ROLLE LED pag. 360-361
DRIVERS & DIMMER
E ROSONI pag. 362-363

 INDEX

 SECTION

 FAMILY 337

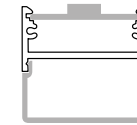

3010M - PROFILO MULTIUSO

BV



3010MZOMT1	profile 100 cm (NO LED)	48,00 €
3010MZOMT2	profile 200 cm (NO LED)	96,00 €
3010MZOMT3	profile 300 cm (NO LED)	144,00 €

 E2 Opale - Opal

 Led non incluso - Led not included - Led nicht inbegriffen
 Alimentatore non incluso - Power Supply not included - Netzteil nicht inbegriffen



2 testate incluse
2 end caps included
2 Endkappen enthalten

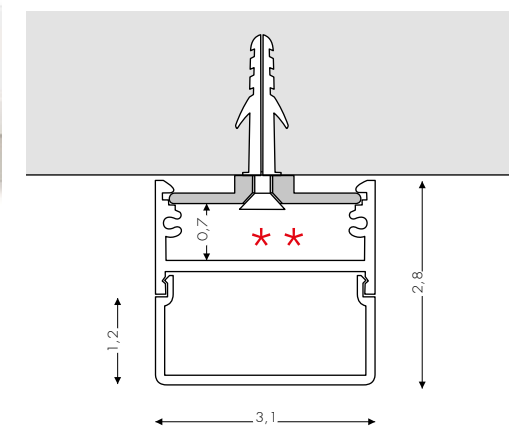

** Possibilità passaggio cavo
Possible cable passage
Eventueller Kabeldurchgang

SERVIZIO SU MISURA

001001A

Taglio Profilo - Cut service

10,00 €



Configura  Configure / Konfigurieren

www.teamitaliailluminazione.it 

CODICE COMPLETO • COMPLETE CODE • VOLLSTÄNDIGE CODE

3010MZOMT2 | **BV** | **E2** + **001001A**

Codice
Code
Code

Finitura
Finishing
Lackierung

Diffusore
Diffuser
Diffusor

SERVICE

STRIP E ROLLE LED pag. 360-361
DRIVERS & DIMMER
E ROSONI pag. 362-363

 INDEX

 SECTION

 FAMILY 339



40100 - VELETTA LUMINOSA

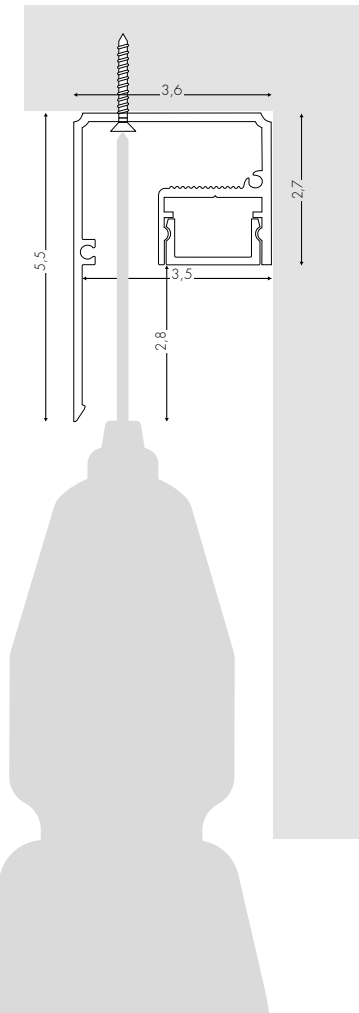

40100Z0MT1	profile 100 cm (NO LED)	52,00 €	58,00 €
40100Z0MT2	profile 200 cm (NO LED)	104,00 €	116,00 €
40100Z0MT3	profile 300 cm (NO LED)	156,00 €	174,00 €

■ E2 Opale - Opal
● L30 Lente 30° - Lens 30° - Linse 30°

✗ Led non incluso - Led not included - Led nicht inbegriffen
✗ Alimentatore non incluso - Power Supply not included - Netzteil nicht inbegriffen

40100GL confezione di giunti meccanici da 5 pz. **48,00 €**

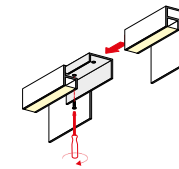

2 testate incluse
2 end caps included
2 Endkappen enthalten



SERVIZIO SU MISURA



001001A Taglio Profilo - Cut service **10,00 €**

Configura Configura / Konfigurieren

www.teamitaliailluminazione.it

CODICE COMPLETO • COMPLETE CODE • VOLLSTÄNDIGE CODE

40100Z0MT3 **BV** **E2** + **001001A**

Codice
Code
Code

Finitura
Finishing
Lackierung

Diffusore
Diffuser
Diffusor

SERVICE

STRIP E ROLLE LED pag. 360-361
DRIVERS & DIMMER
E ROSONI pag. 362-363





4010H - VELETTA LUMINOSA

RASOMURO

BV

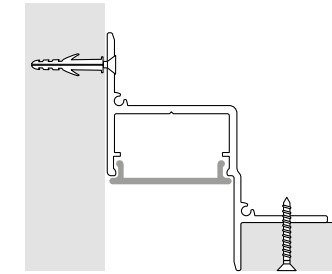

4010HZ0MT1	profile 100 cm (NO LED)	48,00 €
4010HZ0MT2	profile 200 cm (NO LED)	96,00 €
4010HZ0MT3	profile 300 cm (NO LED)	144,00 €

E2 Opale - Opal

Led non incluso - Led not included - Led nicht inbegriffen

Alimentatore non incluso - Power Supply not included - Netzteil nicht inbegriffen



4010HTS coppia di testate - kit of end-caps - Endkappe **11,00 €** A COPPIA

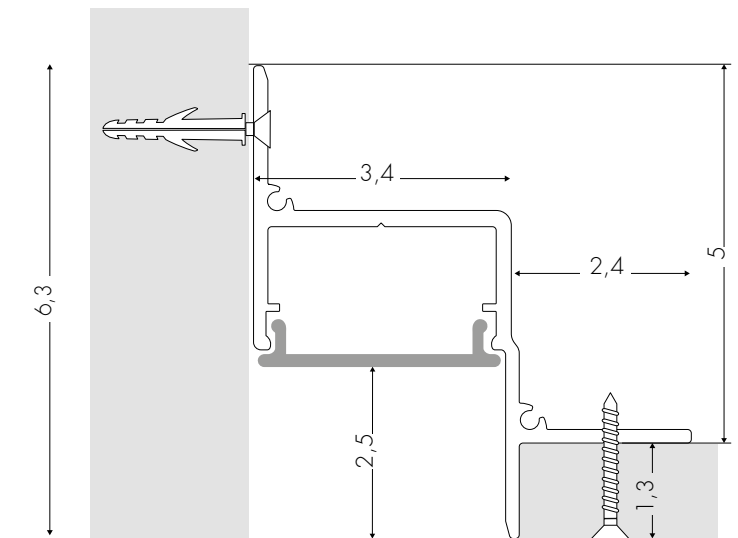

SERVIZIO SU MISURA



001001A Taglio Profilo - Cut service **10,00 €**

Configura Configure / Konfigurieren

www.teamitaliailluminazione.it

CODICE COMPLETO • COMPLETE CODE • VOLLSTÄNDIGE CODE

4010HZ0MT3 **BV** **E2** + **001001A**

Codice
Code
Code

Finitura
Finishing
Lackierung

Diffusore
Diffuser
Diffusor

SERVICE

STRIP E ROLLE LED pag. 360-361
DRIVERS & DIMMER
E ROSONI pag. 362-363

INDEX

SECTION

FAMILY 343



8010D - BIEMISSIONE

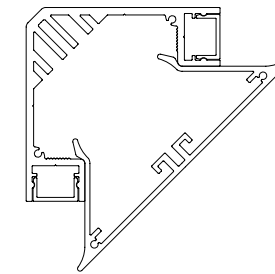

8010DZ0MT1	profile 100 cm (NO LED)	94,00 €	100,00 €
8010DZ0MT2	profile 200 cm (NO LED)	188,00 €	200,00 €
8010DZ0MT3	profile 300 cm (NO LED)	280,00 €	298,00 €

E2 Opale - Opal

Led non incluso - Led not included - Led nicht inbegriffen

Alimentatore non incluso - Power Supply not included - Netzteil nicht inbegriffen



8010DTS coppia di testate - kit of end-caps - Endkappe **20,00 €** A COPPIA

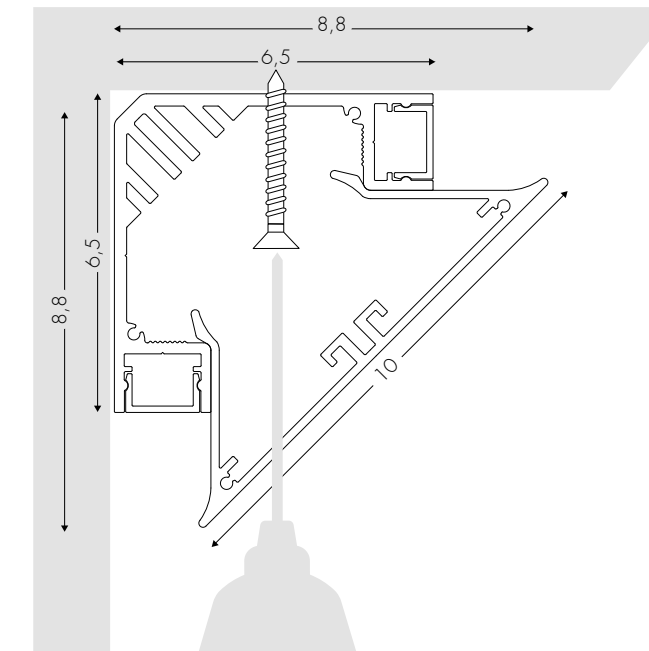

SERVIZIO SU MISURA

001001A Taglio Profilo - Cut service **10,00 €**



Configura Configure / Konfigurieren

www.teamitaliailluminazione.it

CODICE COMPLETO • COMPLETE CODE • VOLLSTÄNDIGE CODE

8010DZ0MT3 **BV** **E2** + **001001A**

Codice
Code
Code

Finitura
Finishing
Lackierung

Diffusore
Diffuser
Diffusor

SERVICE

STRIP E ROLLE LED pag. 360-361
DRIVERS & DIMMER
E ROSONI pag. 362-363





4010 - INCASSO BASIC CON CORNICE

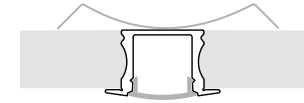

4010ZOMT1	profile 100 cm (NO LED)	41,00 €	30,00 €
4010ZOMT2	profile 200 cm (NO LED)	82,00 €	59,00 €
4010ZOMT25	profile 250 cm (NO LED)	102,00 €	74,00 €

- E2 Opale - Opal
- E28 Satinato - Frosted - Satiniert

- Led non incluso - Led not included - Led nicht inbegriffen
- Alimentatore non incluso - Power Supply not included - Netzteil nicht inbegriffen



2 testate incluse
2 end caps included
2 Endkappen enthalten

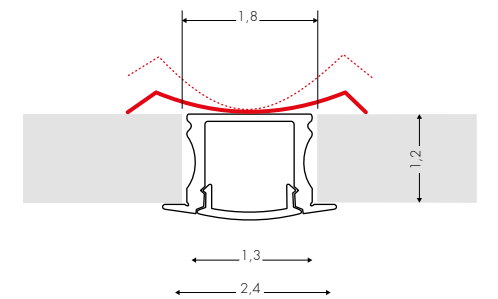

SERVIZIO SU MISURA



001001A

Taglio Profilo - Cut service

10,00 €

Configura Configure / Konfigurieren

www.teamitaliailluminazione.it

CODICE COMPLETO • COMPLETE CODE • VOLLSTÄNDIGE CODE

4010ZOMT25 **BV** **E2** + **001001A**

Codice
Code
Code

Finitura
Finishing
Lackierung

Diffusore
Diffuser
Diffusor

SERVICE

STRIP E ROLLE LED pag. 360-361
DRIVERS & DIMMER
E ROSONI pag. 362-363





PROFILI

INCASSO CON CORNICE
RECESSED PROFILE
EINBAU PROFILE



4010C - INCASSO
CON CORNICE

MURATURA

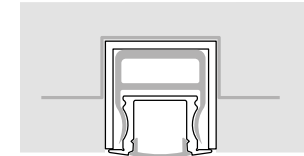

4010CZ0MT1	profile 100 cm (NO LED)	67,00 €	53,00 €
4010CZ0MT2	profile 200 cm (NO LED)	134,00 €	106,00 €
4010CZ0MT25	profile 250 cm (NO LED)	168,00 €	132,00 €

- E2 Opale - Opal
- E28 Satinato - Frosted - Satiniert

- Led non incluso - Led not included - Led nicht inbegriffen
- Alimentatore non incluso - Power Supply not included - Netzteil nicht inbegriffen

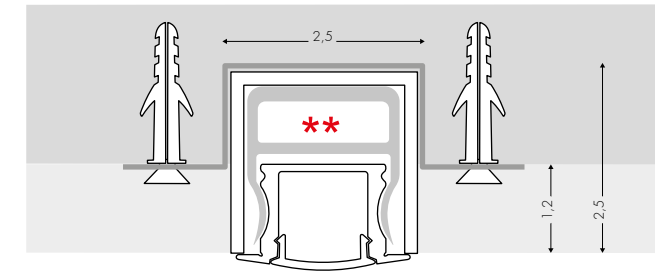

**Possibilità passaggio cavo
Passage for electrical cables
Durchgang für elektrische Kabel

SERVIZIO SU MISURA



001001A Taglio Profilo - Cut service 10,00 €

Configura Configure / Konfigurieren

www.teamitaliailluminazione.it

CODICE COMPLETO • COMPLETE CODE • VOLLSTÄNDIGE CODE

4010CZ0MT25 **BV** **E2** + **001001A**

Codice
Code
Code

Finitura
Finishing
Lackierung

Diffusore
Diffuser
Diffusor

SERVICE

STRIP E ROLLE LED pag. 360-361
DRIVERS & DIMMER
E ROSONI pag. 362-363





4010M - INCASSO CON CORNICE

BV
□

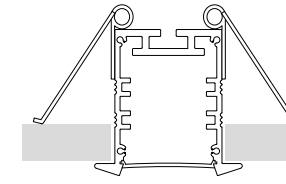

4010MZ0MT1	profile 100 cm (NO LED)	130,00 €
4010MZ0MT2	profile 200 cm (NO LED)	260,00 €
4010MZ0MT25	profile 250 cm (NO LED)	325,00 €

- E2 Opale - Opal
- E19 Prismatico - Prismatic - Prismatisch

- ✗ Led non incluso - Led not included - Led nicht inbegriffen
- ✗ Alimentatore non incluso - Power Supply not included - Netzteil nicht inbegriffen

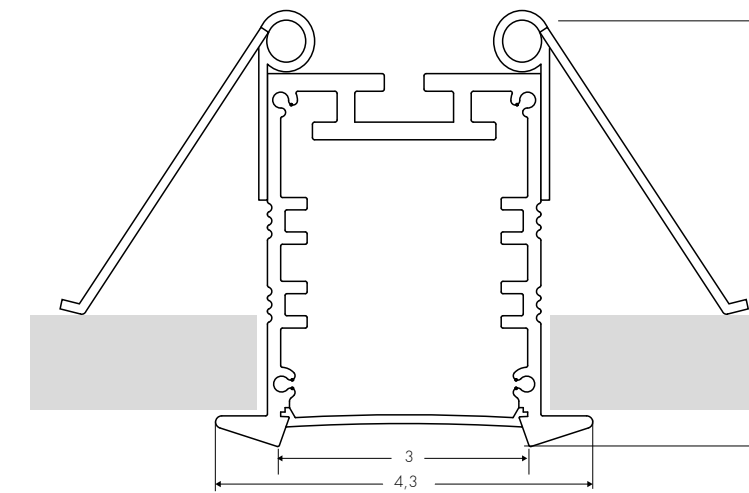

2 testate incluse
2 end caps included
2 Endkappen enthalten

SERVIZIO SU MISURA

001001A

Taglio Profilo - Cut service

10,00 €



Configura Configura / Konfigurieren

www.teamitaliailluminazione.it

CODICE COMPLETO • COMPLETE CODE • VOLLSTÄNDIGE CODE

4010MZ0MT25 **BV** **E2** + **001001A**

Codice
Code
Code

Finitura
Finishing
Lackierung

Diffusore
Diffuser
Diffusor

SERVICE

STRIP E ROLLE LED pag. 360-361
DRIVERS & DIMMER
E ROSONI pag. 362-363

INDEX

SECTION

FAMILY 351



PROFILI

INCASSO CON CORNICE
RECESSED PROFILE
EINBAU PROFILE



4010L - INCASSO CON CORNICE

BV
□

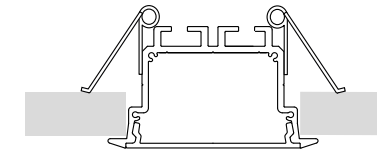

4010LZ0MT1	profile 100 cm (NO LED)	139,00 €
4010LZ0MT2	profile 200 cm (NO LED)	278,00 €
4010LZ0MT25	profile 250 cm (NO LED)	348,00 €

- E2 Opale - Opal
- E19 Prismatico - Prismatic - Prismatisch
- ✗ Led non incluso - Led not included - Led nicht inbegriffen
- ✗ Alimentatore non incluso - Power Supply not included - Netzteil nicht inbegriffen

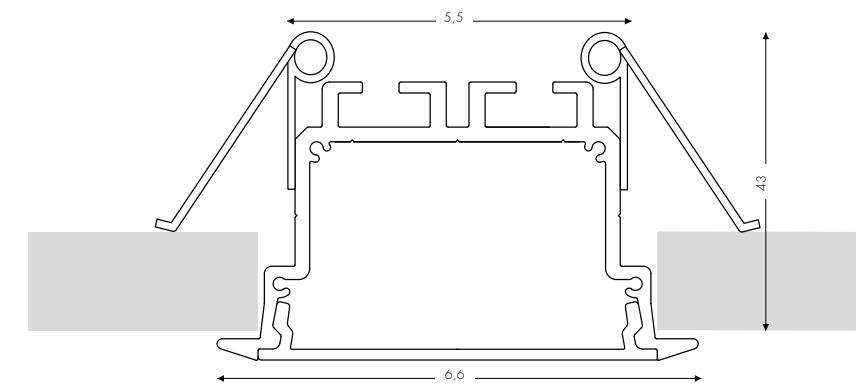

2 testate incluse
2 end caps included
2 Endkappen enthalten

SERVIZIO SU MISURA

001001A

Taglio Profilo - Cut service

10,00 €



Configura Configure / Konfigurieren

www.teamitaliailluminazione.it

CODICE COMPLETO • COMPLETE CODE • VOLLSTÄNDIGE CODE

4010LZ0MT25 **BV** **E2** + **001001A**

Code	Finitura	Diffusore	SERVICE
Code	Finishing	Diffuser	
Code	Lackierung	Diffusor	

STRIP E ROLLE LED pag. 360-361
DRIVERS & DIMMER
E ROSONI pag. 362-363

INDEX

SECTION

FAMILY 353



4010I - INCASSO A RASO

CARTONGESSO
ESCLUSO

BV

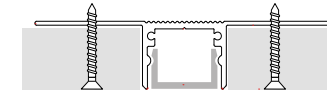

4010IZOMT1	profile 100 cm (NO LED)	40,00 €
4010IZOMT2	profile 200 cm (NO LED)	80,00 €
4010IZOMT3	profile 300 cm (NO LED)	120,00 €

E2 Opale - Opal

Led non incluso - Led not included - Led nicht inbegriffen

Alimentatore non incluso - Power Supply not included - Netzteil nicht inbegriffen

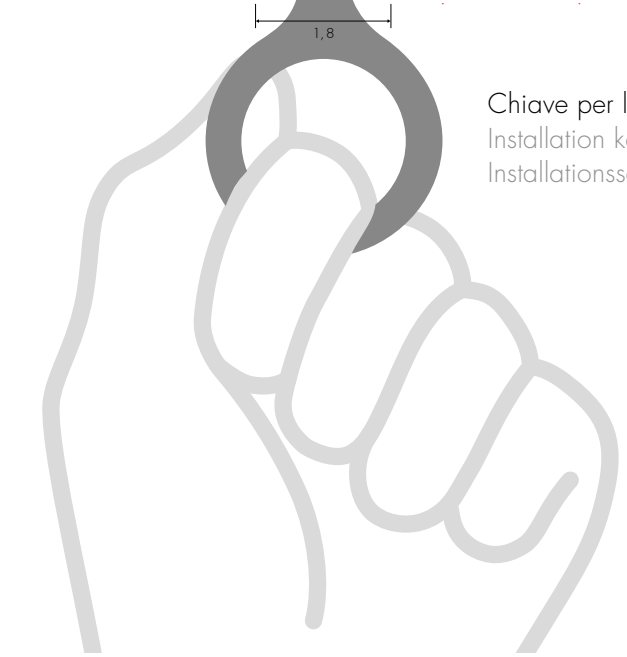
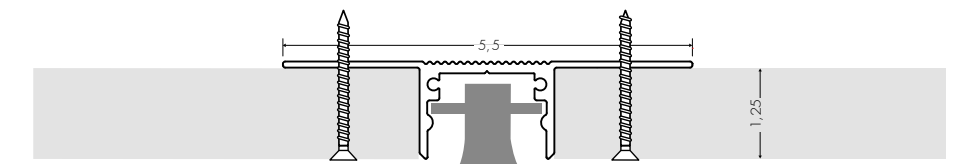

Chiave per l'installazione
Installation key
Installationschlüssel

SERVIZIO SU MISURA



001001A Taglio Profilo - Cut service **10,00 €**

Configura Configure / Konfigurieren

www.teamitaliailluminazione.it

CODICE COMPLETO • COMPLETE CODE • VOLLSTÄNDIGE CODE

4010IZOMT2 **BV** **E2** + **001001A**

Codice
Code
Code

Finitura
Finishing
Lackierung

Diffusore
Diffuser
Diffusor

SERVICE

STRIP E ROLLE LED pag. 360-361
DRIVERS & DIMMER
E ROSONI pag. 362-363

INDEX

SECTION

FAMILY 355



4010N - INCASSO A RASO

CARTONGESSO
INCLUSO

BV

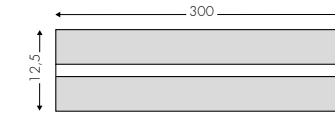

4010NZ0MT1
4010NZ0MT2
4010NZ0MT3

profile 100 cm (NO LED)
profile 200 cm (NO LED)
profile 300 cm (NO LED)

52,00 €
104,00 €
156,00 €

E2 Opale - Opal

Led non incluso - Led not included - Led nicht inbegriffen

Alimentatore non incluso - Power Supply not included - Netzteil nicht inbegriffen

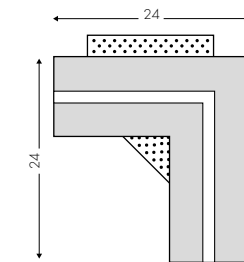

4010NAZO

24x24 cm. (NO LED)

84,00 €

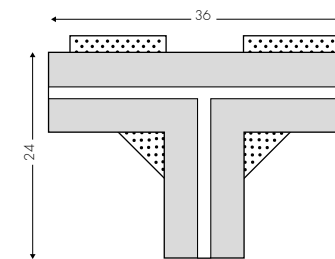

4010NTZO

36x24 cm. (NO LED)

104,00 €

SERVIZIO SU MISURA

001001A

Taglio Profilo - Cut service

10,00 €



Configura

Configure / Konfigurieren

www.teamitaliailluminazione.it

CODICE COMPLETO • COMPLETE CODE • VOLLSTÄNDIGE CODE

4010NZ0MT3 **BV** **E2** + **001001A**

Codice
Code
Code

Finitura
Finishing
Lackierung

Diffusore
Diffuser
Diffusor

SERVICE

STRIP E ROLLE LED pag. 360-361
DRIVERS & DIMMER
E ROSONI pag. 362-363

INDEX

SECTION

FAMILY 357



4010F - INCASSO A RASO

MURATURA

BV

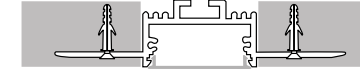

4010FZ0MT1
4010FZ0MT2
4010FZ0MT3

profile 100 cm (NO LED)
profile 200 cm (NO LED)
profile 300 cm (NO LED)

46,00 €
92,00 €
138,00 €

E2 Opale - Opal

Led non incluso - Led not included - Led nicht inbegriffen

Alimentatore non incluso - Power Supply not included - Netzteil nicht inbegriffen

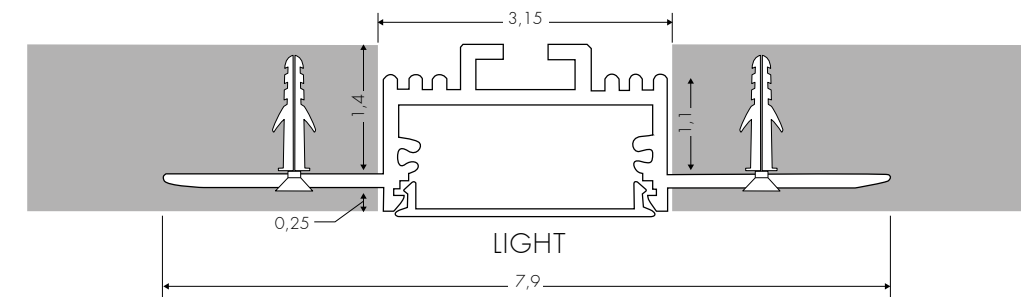

2 testate incluse
2 end caps included
2 Endkappen enthalten

SERVIZIO SU MISURA

001001A

Taglio Profilo - Cut service

10,00 €



Configura

Configure / Konfigurieren

www.teamitaliailluminazione.it

CODICE COMPLETO • COMPLETE CODE • VOLLSTÄNDIGE CODE

4010FZ0MT2 **BV** **E2** + **001001A**

Code
Code
Code

Finitura
Finishing
Lackierung

Diffusore
Diffuser
Diffusor

SERVICE

STRIP E ROLLE LED pag. 360-361
DRIVERS & DIMMER
E ROSONI pag. 362-363

INDEX

SECTION

FAMILY 359

STRIPLED IP20

14.4W/mt



●	90101427K20MT	14,4W 1900lm/mt - 24VDC 2700K IP20 (1 mt)	13,00 € /mt
●	90101430K20MT	14,4W 1900lm/mt - 24VDC 3000K IP20 (1 mt)	13,00 € /mt
○	90101440K20MT	14,4W 1900lm/mt - 24VDC 4000K IP20 (1 mt)	13,00 € /mt
●	901014RGB20MT	14,4W 600lm/mt - 24VDC RGB IP20 (1 mt)	14,00 € /mt

Configura Configura / Konfigurieren www.teamitaliailluminazione.it

22W/mt



●	90102227K20MT	22W 2880lm/mt - 24VDC 2700K IP20 (1 mt)	32,00 € /mt
●	90102230K20MT	22W 2880lm/mt - 24VDC 3000K IP20 (1 mt)	32,00 € /mt
○	90102240K20MT	22W 2880lm/mt - 24VDC 4000K IP20 (1 mt)	32,00 € /mt

Configura Configura / Konfigurieren www.teamitaliailluminazione.it

STRIPLED IP65

14.4W/mt



●	90101427K65MT	14,4W 1900lm/mt - 24VDC 2700K IP65 (1 mt)	15,00 € /mt
●	90101430K65MT	14,4W 1900lm/mt - 24VDC 3000K IP65 (1 mt)	15,00 € /mt
○	90101440K65MT	14,4W 1900lm/mt - 24VDC 4000K IP65 (1 mt)	15,00 € /mt
●	901014RGB65MT	14,4W 600lm/mt - 24VDC RGB IP65 (1 mt)	16,00 € /mt

Configura Configura / Konfigurieren www.teamitaliailluminazione.it

22W/mt



●	90102227K65MT	22W 2880lm/mt - 24VDC 2700K IP65 (1 mt)	37,00 € /mt
●	90102230K65MT	22W 2880lm/mt - 24VDC 3000K IP65 (1 mt)	37,00 € /mt
○	90102240K65MT	22W 2880lm/mt - 24VDC 4000K IP65 (1 mt)	37,00 € /mt

Configura Configura / Konfigurieren www.teamitaliailluminazione.it

*SERVIZIO SU MISURA (S.M.)



001002A Taglio strip e saldatura - Cut service and soldering 12,00 €

ROLLE 5MT IP20

14.4W/mt



●	90101442700	14,4W 1900lm/mt - 24VDC 2700K IP20 (5mt)	60,00 €
●	90101443000	14,4W 1900lm/mt - 24VDC 3000K IP20 (5mt)	60,00 €
○	90101444000	14,4W 1900lm/mt - 24VDC 4000K IP20 (5mt)	60,00 €
●	9010144RGB	14,4W 600lm/mt - 24VDC RGB IP20 (5mt)	66,00 €

Configura Configura / Konfigurieren www.teamitaliailluminazione.it

22W/mt



●	9010222700	22W 2880lm/mt - 24VDC 2700K IP20 (5mt)	152,00 €
●	9010223000	22W 2880lm/mt - 24VDC 3000K IP20 (5mt)	152,00 €
○	9010224000	22W 2880lm/mt - 24VDC 4000K IP20 (5mt)	152,00 €

Configura Configura / Konfigurieren www.teamitaliailluminazione.it

ROLLE 5MT IP65

14.4W/mt



●	90101442700IP65	14,4W 1900lm/mt - 24VDC 2700K IP65 (5mt)	72,00 €
●	90101443000IP65	14,4W 1900lm/mt - 24VDC 3000K IP65 (5mt)	72,00 €
○	90101444000IP65	14,4W 1900lm/mt - 24VDC 4000K IP65 (5mt)	72,00 €
●	9010144RGBIP65	14,4W 600lm/mt - 24VDC RGB IP65 (5mt)	79,00 €

Configura Configura / Konfigurieren www.teamitaliailluminazione.it

22W/mt



●	9010222700IP65	22W 2880lm/mt - 24VDC 2700K IP65 (5mt)	180,00 €
●	9010223000IP65	22W 2880lm/mt - 24VDC 3000K IP65 (5mt)	180,00 €
○	9010224000IP65	22W 2880lm/mt - 24VDC 4000K IP65 (5mt)	180,00 €

Configura Configura / Konfigurieren www.teamitaliailluminazione.it

CODICE COMPLETO • COMPLETE CODE • VOLLSTÄNDIGE CODE

4 X **90101427K20MT** + 1 X **001002A**
STRIPLED SERVICE

CODICE COMPLETO • COMPLETE CODE • VOLLSTÄNDIGE CODE

90101442700IP65
ROLLE

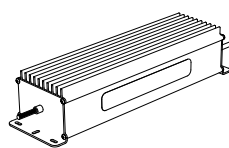

DRIVERS 24V ON/OFF

AE003A	Driver 30W - On/Off 24V / IP20	29,00 €
AE003B	Driver 75W - On/Off 24V / IP20	45,00 €
AE003C	Driver 100W - On/Off 24V / IP65	74,00 €
AE003D	Driver 150W - On/Off 24V / IP65	98,00 €
AE003E	Driver 240W - On/Off 24V / IP65	127,00 €

DRIVERS 24V TRIAC

AE005A	Driver 100W - Triac 24V / IP20	124,00 €
AE005B	Driver 200W - Triac 24V / IP65	198,00 €

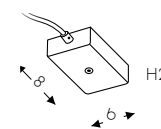

AM002A

Solo collegamento elettrico rettangolo
Only electrical connection rectangle
Nur elektrische Verbindung Rechteck

28,00 €

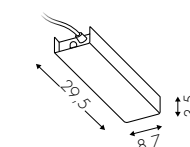

9010XS

Può contenere alimentatore: 30W/75W-24VDC
It can contains power supply: 30W/75W-24VDC
Es kann Netzteil enthalten: 30W/75W-24VDC

72,00 €

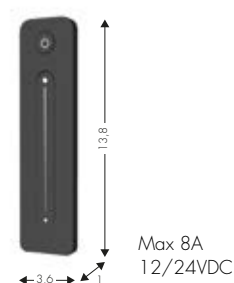

DIMMER (Alimentatore escluso)

9010SMARTMD **74,00 €**

9010SMARTRGB **86,00 €**

Dispositivo per la gestione di sorgenti led con Radiocomando.
Led light remote control.
Gerät für die Verwaltung Led-Lichtquellen mit Fernsteuerung.

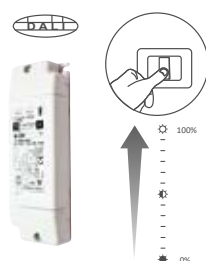

90106002 **79,00 €**

Dispositivo per la gestione di sorgenti led a luce monocromatica con Pulsante o con sistema Domotico DALI.
Monochromatic led light manager with button or DALI domotic system.
Gerät für die Verwaltung von monochromatischem Led-Lichtquellen mit Druckknopfschaltung oder DALI Domotik.



9010BTMD **163,00 €**

Da utilizzare con Dimmer 90106002 (non incluso)
Mit Dimmer 90106002 (nicht enthalten)
With Dimmer 90106002 (not included)

Dispositivo Bluetooth per rendere dimmerabili Wireless da remoto i nostri prodotti in versione "DM" (DALI).
Our products DM dimmable (DALI) products are compatible with Tridonic module for remote bluetooth dimming.
Bluetooth-Gerät, um unsere "DM" (DALI) Produkte Wireless dimmbar zu machen.

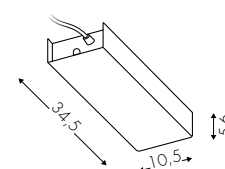

9010M

Può contenere alimentatore: 75W, 100W, 150W
It can contains power supply: 75W, 100W, 150W
Es kann Netzteil enthalten: 240W

86,00 €

75W + 90106002
100W + 90106002
150W + 90106002
240W + 90106002

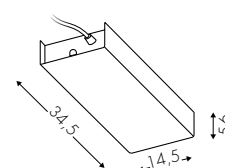

9010L

Può contenere alimentatore: 2x150W - 2x240W
It can contains power supply: 2x150W - 2x240W
Es kann Netzteil enthalten: 2x150W - 2x240W

97,00 €

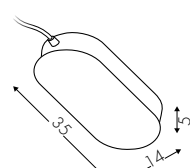

AM004A

Può contenere alimentatore: 75W, 100W, 150W
It can contains power supply: 75W, 100W, 150W
Es kann Netzteil enthalten: 240W

68,00 €

75W + 90106002
100W + 90106002
150W + 90106002
240W + 90106002

CODICE COMPLETO • COMPLETE CODE • VOLLSTÄNDIGE CODE

AE003A

Codice
Code
Code

CODICE COMPLETO • COMPLETE CODE • VOLLSTÄNDIGE CODE

9010L **BV**

Codice
Code
Code
Finitura
Finishing
Lackierung

Outdoor

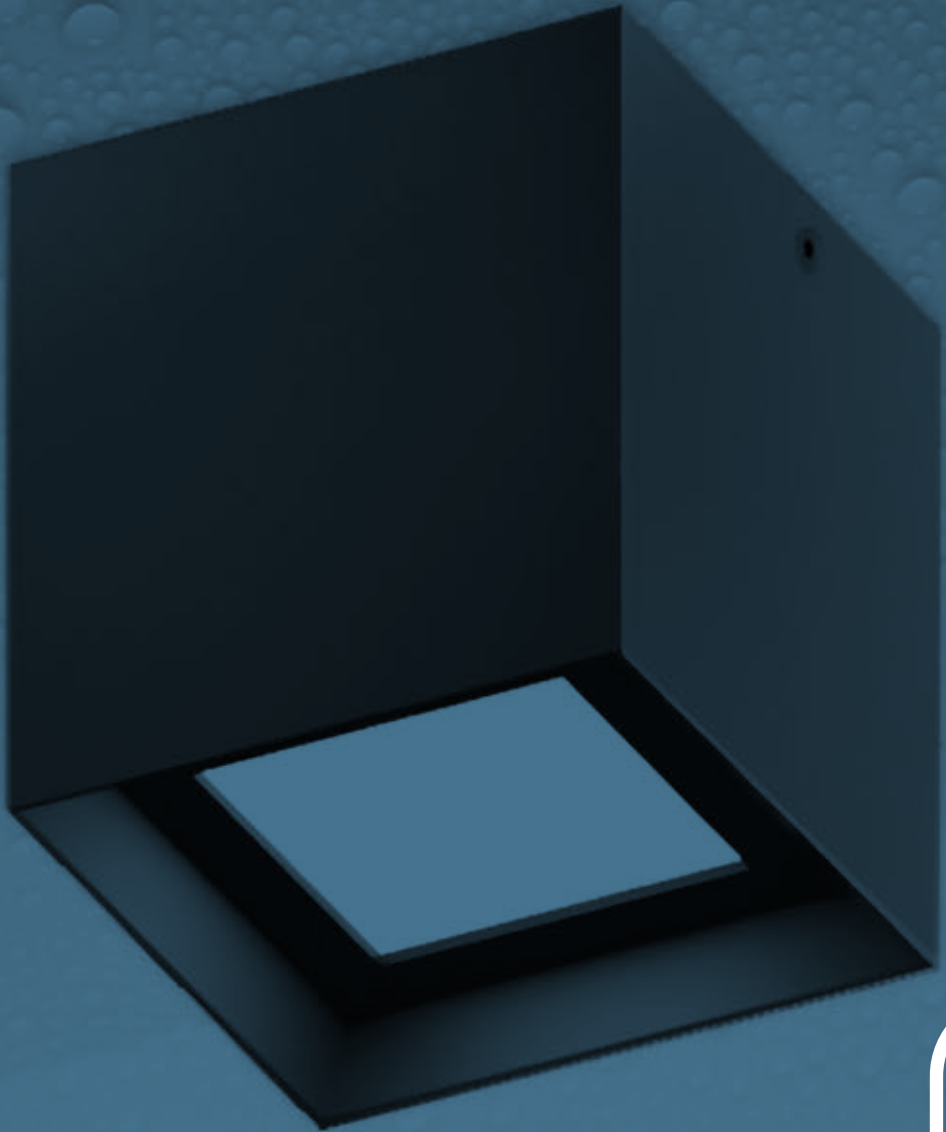

Sospensione/Hanging lamp/Pendelleuchte



Bellai Outdoor
downlight Ø70/Ø95

369



Leggera Outdoor
downlight Ø65/Ø82/Ø110/Ø160

371



Mirò IP54
downlight (1-10m)

373

Plafone/Ceiling/Deckenleuchte



Bellai Outdoor
downlight Ø70/Ø95

375



Iglù
downlight Ø25/Ø40

377



Leggera Outdoor
downlight Ø65/Ø82

379



Leggera Outdoor
downlight L170

381



Mirò IP54
downlight (1-10m)

383



Oki Outdoor
downlight L8x8 H9/L15x15 H8
L15x15 H17

385



Oki Outdoor
downlight L8x8 H9

385



Drop
orientabile [50-250cm]

386



Wet Plus+
downlight 125/155cm

391

Parete/Wall light/Wandleuchte

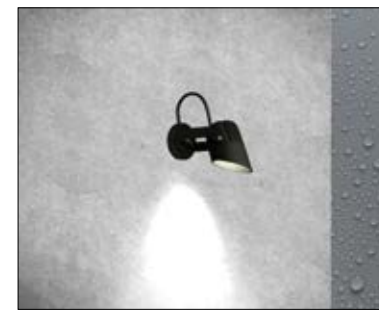

Flip
orientabile 8W

393

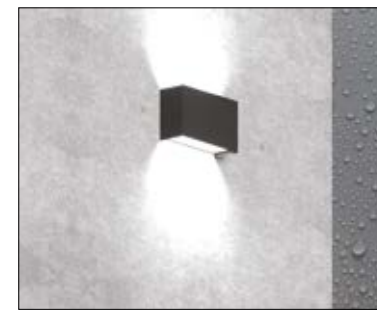

Simply Outdoor
up+downlight L18

395

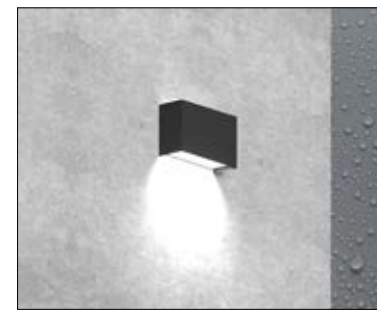

Simply Outdoor
downlight L18

395

Incasso/Recessed/Einbauchte



S-Pot Outdoor
downlight cartongesso Ø8-8W / Ø11-13W

397

Fissaggio a terra/Ground fixing/Bodenbefestigung



Dot
uplight Ø4-1W

399



Dot
uplight Ø5,6-3W

400



Dot
uplight Ø7-7W

401



Dot
laterale Asimetrico-3W

403



Dot
laterale Simmetrico-3W

405



Flip 24V
orientabile 60cm/100cm 7W

407



Flip 220V
orientabile (picchetto) 8W

409



configurazione standard: / basic configuration: / Standard Konfiguration:

E2 Opale - Opal

B 3000K

BV



1025AOF54BVE2B

50W 3810lm* - 220V

1.501,00 €

1025ADM54BVE2B

DALI (Push) - 50W 3810lm - 220V

1.656,00 €

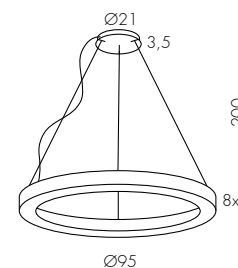
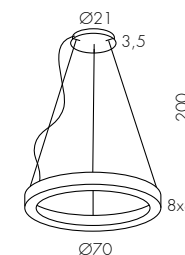

1025BOF54BVE2B

65W 5168lm - 220V

1.891,00 €

1025BDM54BVE2B

DALI (Push) - 65W 5168lm - 220V

2.077,00 €

Configura

Configure / Konfigurieren

www.teamitaliailluminazione.it



A 2700K

NE RU



CODICE COMPLETO DEL PRODOTTO NELLA FOTO
FULL PRODUCT CODE AS SHOWN IN PICTURE - VOLLSTÄNDIGER CODE VOM ARTIKEL IM BILD

1025AOF54 **NE** **E2** **B**

Codice
Code

Finitura
Finishing
Lackierung

Diffusore
Diffuser
Diffusor

Tonalità
Hue
Farbton

BV NE RU

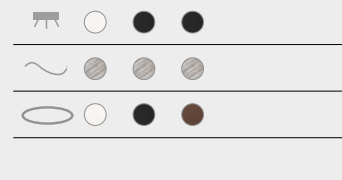

A Alimentatore Incorporato - Incorporated power supply - Eingebautes Netzteil

* 3810lm effettivi - effective - effektive con - with - mit **E2**



LEGGERA

SOSPENSIONE
SUSPENSION LAMP
PENDELLEUCHE



configurazione standard: / basic configuration: / Standard Konfiguration:

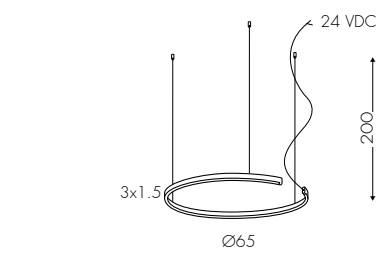

E2 Opale - Opal

B 3000K

BV



1032A54BVE2B

35W 1740lm* - 24VDC

575,00 €

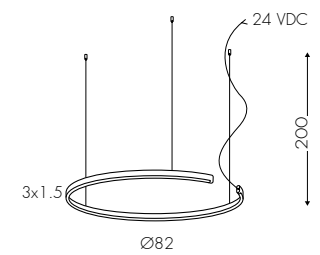

1032B54BVE2B

48W 2580lm - 24VDC

697,00 €

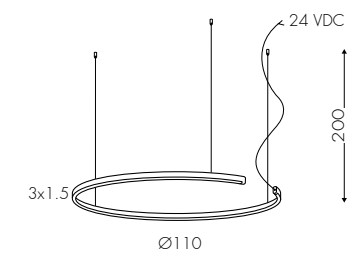

1032C54BVE2B

65W 3300lm - 24VDC

820,00 €

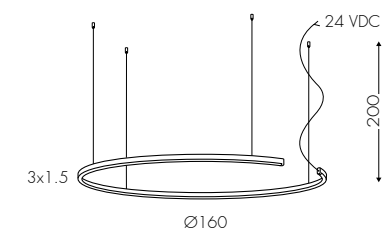

1032D54BVE2B

90W 4980lm - 24VDC

1.308,00 €

Configura

Configure / Konfigurieren

www.teamitaliailluminazione.it



A 2700K

NE



CODICE COMPLETO DEL PRODOTTO NELLA FOTO
FULL PRODUCT CODE AS SHOWN IN PICTURE - VOLLSTÄNDIGER CODE VOM ARTIKEL IM BILD

1032D54 | **NE** | **E2** | **B**

Codice
Code

Finitura
Finishing
Lackierung

Diffusore
Diffuser
Diffusor

Tonalità
Hue
Farbton

BV

NE

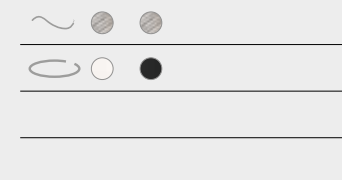

Alimentatore non incluso - Power supply not included - Netzteil nicht inbegriffen

Alimentatori IP65 a pag. 564-565 - IP65 Drivers p. 564-565 - Netzteil IP65 p. 564-565

* 1740lm effettivi - effective - effektive con - with - mit **E2**

INDEX

SECTION

FAMILY 371

MIRÓ IP54 DOWNLIGHT (1-10mt)

SOSPENSIONE
SUSPENSION LAMP
PENDELLEUCHTE



configurazione standard: / basic configuration: / Standard Konfiguration:

E2 Opale - Opal

B 3000K

BV

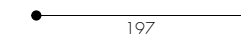
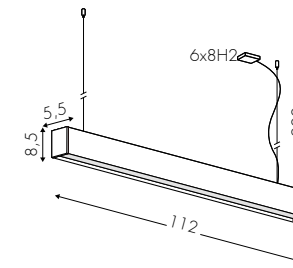

1085BOFBVE2B
1085BDMBVE2B

25W 1910lm* - 220V
DALI (Push) - 25W 1910lm - 220V

357,00 €
413,00 €

1085EOFBVE2B
1085EDMBVE2B

44W 3350lm - 220V
DALI (Push) - 44W 3350lm - 220V

461,00 €
522,00 €

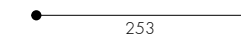

1085GOFBVE2B
1085GDMBVE2B

56W 4305lm - 220V
DALI (Push) - 56W 4305lm - 220V

569,00 €
616,00 €

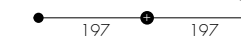
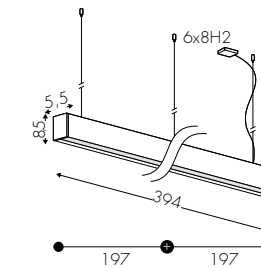

1085LOFBVE2B
1085LDMBVE2B

87W 6705lm - 220V
DALI (Push) - 87W 6705lm - 220V

1.001,00 €
1.150,00 €

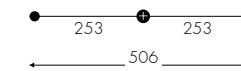

1085MOFBVE2B
1085MDMBVE2B

111W 8605lm - 220V
DALI (Push) - 111W 8605m - 220V

1.174,00 €
1.291,00 €



1085ROFBVE2B
1085RDMBVE2B

223W 17210lm - 220V
DALI (Push) - 223W 17210lm - 220V

2.593,00 €
2.848,00 €

Configura

Configure / Konfigurieren

www.teamitaliailluminazione.it



C 4000K

NE



CODICE COMPLETO DEL PRODOTTO NELLA FOTO
FULL PRODUCT CODE AS SHOWN IN PICTURE
VOLLSTÄNDIGER CODE VOM ARTIKEL IM BILD

1085EOF **NE** **E2** **B**

Codice
Code

Finitura
Finishing
Lackierung

Diffusore
Diffuser
Diffusor

Tonalità
Hue
Farbton

BV

NE

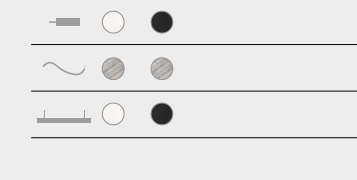

A Alimentatore Incorporato - Incorporated Power Supply - Eingebautes Netzteil

* 1910lm effettivi - effective - effektive con - with - mit E2

INDEX

SECTION

FAMILY 373



configurazione standard: / basic configuration: / Standard Konfiguration:

E2 Opale - Opal ● B 3000K

BV

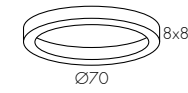

3025AOF54BVE2B 50W 3810lm* - 220V 1.463,00 €
3025ADM54BVE2B DALI (push) - 50W 3810lm - 220V 1.617,00 €

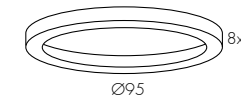

3025BOF54BVE2B 65W 5168lm - 220V 1.829,00 €
3025BDM54BVE2B DALI (push) - 65W 5168lm - 220V 2.014,00 €

Configura  Configure / Konfigurieren

www.teamitaliailluminazione.it 



● A 2700K

NE RU

A Alimentatore Incorporato - Incorporated power supply - Eingebautes Netzteil

* 3810lm effettivi - effective - effektive con - with - mit E2

 CODICE COMPLETO DEL PRODOTTO NELLA FOTO
FULL PRODUCT CODE AS SHOWN IN PICTURE - VOLLSTÄNDIGER CODE VOM ARTIKEL IM BILD

3025AOF54 **NE** **E2** **B**

Codice
Code

Finitura
Finishing
Lackierung

Diffusore
Diffuser
Diffusor

Tonalità
Hue
Farbton





configurazione standard: / basic configuration: / Standard Konfiguration:

E2 Opale - Opal

● B 3000K

BV

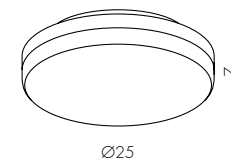

3080BOFBVE2B

12W 1300lm* - 220V

78,00 €

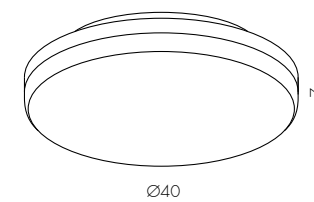

3080DOFBVE2B

30W 3000lm - 220V

148,00 €

Configura 

Configure / Konfigurieren

www.teamitaliailluminazione.it 



A Alimentatore Incorporato - Incorporated Power Supply - Eingebautes Netzteil

* 1300lm effettivi - effective - effektiven con - with - mit **E2**

 **CODICE COMPLETO DEL PRODOTTO NELLA FOTO**
FULL PRODUCT CODE AS SHOWN IN PICTURE - VOLLSTÄNDIGER CODE VOM ARTIKEL IM BILD

3080DOF **BV** **E2** **B**

Codice Code	Finitura Finishing Lackierung	Diffusore Diffuser Diffusor	Tonalità Hue Farbton
----------------	-------------------------------------	-----------------------------------	----------------------------

LEGGERA

PLAFONE
CEILING LIGHT
DECKENLEUCHTE



configurazione standard: / basic configuration: / Standard Konfiguration:

E2 Opale - Opal

● B 3000K

BV

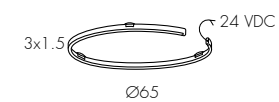

3032A54BVE2B

35W 1740lm* - 24VDC

575,00 €

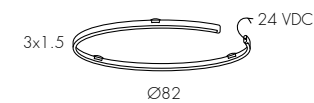

3032B54BVE2B

48W 2580lm - 24VDC

697,00 €

Configura

Configure / Konfigurieren

www.teamitaliailluminazione.it



● A 2700K

NE

Alimentatore non incluso - Power supply not included - Netzteil nicht inbegriffen

Alimentatori IP65 a pag. 564-565 - IP65 Drivers p. 564-565 - Netzteil IP65 p. 564-565

* 1740lm effettivi - effective - effektive con - with - mit **E2**

CODICE COMPLETO DEL PRODOTTO NELLA FOTO
FULL PRODUCT CODE AS SHOWN IN PICTURE - VOLLSTÄNDIGER CODE VOM ARTIKEL IM BILD

3032B54 | **NE** | **E2** | **B**

Codice
Code

Finitura
Finishing
Lackierung

Diffusore
Diffuser
Diffusor

Tonalità
Hue
Farbton

INDEX

SECTION

FAMILY 379

configurazione standard: / basic configuration: / Standard Konfiguration:

E2 Opale - Opal ● B 3000K

BV

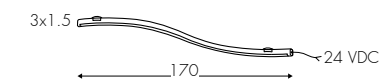

3032G54BVE2B

35W 1740lm* - 24VDC

487,00 €



Configura  Configure / Konfigurieren

www.teamitaliailluminazione.it 



● A 2700K

NE



 **CODICE COMPLETO DEL PRODOTTO NELLA FOTO**
FULL PRODUCT CODE AS SHOWN IN PICTURE - VOLLSTÄNDIGER CODE VOM ARTIKEL IM BILD

3032G54 | **NE** | **E2** | **B**

Codice
Code

Finitura
Finishing
Lackierung

Diffusore
Diffuser
Diffusor

Tonalità
Hue
Farbton

 Alimentatore non incluso - Power supply not included - Netzteil nicht inbegriffen

Alimentatori IP65 a pag. 564-565 - IP65 Drivers p. 564-565 - Netzteil IP65 p. 564-565

* 1740lm effettivi - effective - effektive con - with - mit **E2**

MIRÓ IP54

PLAFONE
CEILING LIGHT
DECKENLEUCHTE



configurazione standard: / basic configuration: / Standard Konfiguration:

E2 Opale - Opal

● B 3000K

BV

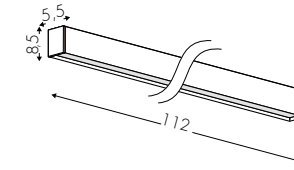

3085BOFBVE2B
3085BDMBVE2B

25W 1910lm* - 220V
DALI (Push) - 25W 1910lm - 220V

355,00 €
410,00 €

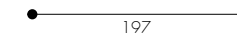

3085EOFBVE2B
3085EDMBVE2B

44W 3350lm - 220V
DALI (Push) - 44W 3350lm - 220V

482,00 €
542,00 €

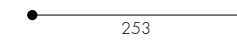

3085GOFBVE2B
3085GDMBVE2B

56W 4305lm - 220V
DALI (Push) - 56W 4305lm - 220V

589,00 €
636,00 €

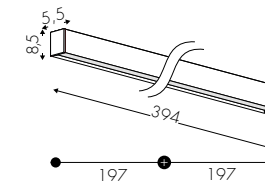

3085LOFBVE2B
3085LDMBVE2B

87W 6705lm - 220V
DALI (Push) - 87W 6705lm - 220V

1.059,00 €
1.209,00 €

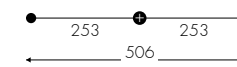

3085MOFBVE2B
3085MDMBVE2B

111W 8605lm - 220V
DALI (Push) - 111W 8605lm - 220V

1.224,00 €
1.342,00 €



3085ROFBVE2B
3085RDMBVE2B

124W 17210lm - 220V
DALI (Push) - 124W 17210lm - 220V

2.607,00 €
2.943,00 €

Configura

Configure / Konfigurieren

www.teamitaliailluminazione.it



● C 4000K

NE

A Alimentatore Incorporato - Incorporated Power Supply - Eingebautes Netzteil

* 1910lm effettivi - effective - effektive con - with - mit **E2**

↑ CODICE COMPLETO DEL PRODOTTO NELLA FOTO
FULL PRODUCT CODE AS SHOWN IN PICTURE
VOLLSTÄNDIGER CODE VOM ARTIKEL IM BILD

3085EOF **NE** **E2** **B**

Codice
Code

Finitura
Finishing
Lackierung

Diffusore
Diffuser
Diffusor

Tonalità
Hue
Farbton

INDEX

SECTION

FAMILY 383



configurazione standard: / basic configuration: / Standard Konfiguration:

E28 Satinato
Frosted - Satiniert ● B 3000K BV

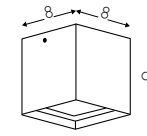

3009AOF54BVE28B 13W 1000lm* - 220V **180,00 €**

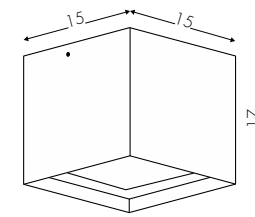

3009COF54BVE28B 20W 1700lm - 220V **299,00 €**

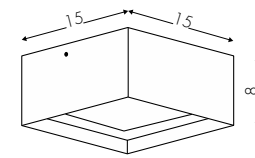

3009DOF54BVE28B 20W 1700lm - 220V **269,00 €**

Configura Configure / Konfigurieren

www.teamitaliailluminazione.it



C 4000K

NE RU

configurazione standard: / basic configuration: / Standard Konfiguration:

E28 Satinato
Frosted - Satiniert ● B 3000K BV

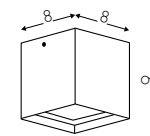

3009P54BVE28B 9W 900lm - 24VDC **221,00 €**

24V

Configura Configure / Konfigurieren

www.teamitaliailluminazione.it



C 4000K

NE RU

CODICE COMPLETO DEL PRODOTTO NELLA FOTO
FULL PRODUCT CODE AS SHOWN IN PICTURE - VOLLSTÄNDIGER CODE VOM ARTIKEL IM BILD

3009AOF54 **NE** **E28** **B**

Codice
Code

Finitura
Finishing
Lackierung

Diffusore
Diffuser
Diffusor

Tonalità
Hue
Farbton

Alimentatore Incorporato - Incorporated Power Supply - Eingebautes Netzteil
 Alimentatore non incluso - Power Supply not included - Netzteil nicht inbegriffen

Alimentatori IP65 a pag. 564-565 - IP65 Drivers p. 564-565 - Netzteil IP65 p. 564-565

* 1000lm effettivi - effective - effektive con - with - mit **E28**

22W/mt



6010DV13	50cm 22W/mt 2300lm/mt - 24VDC	171,00 €
6010DV23	100cm 22W/mt 2300lm/mt - 24VDC	222,00 €
6010DV33	150cm 22W/mt 2300lm/mt - 24VDC	298,00 €
6010DV43	200cm 22W/mt 2300lm/mt - 24VDC	378,00 €
6010DV53	250cm 22W/mt 2300lm/mt - 24VDC	454,00 €

14.4W/mt



6010DV11	50cm 14.4W/mt 1600lm* /mt - 24VDC	150,00 €
6010DV21	100cm 14.4W/mt 1600lm/mt - 24VDC	186,00 €
6010DV31	150cm 14.4W/mt 1600lm/mt - 24VDC	244,00 €
6010DV41	200cm 14.4W/mt 1600lm/mt - 24VDC	305,00 €
6010DV51	250cm 14.4W/mt 1600lm/mt - 24VDC	356,00 €



ACCIAIO CROMATO
CHROME STEEL
CHROMSTAHL

AISI 303



L30 Lente 30° - Lens 30° - Linse 30°
L220 Lente 220° - Lens 220° - Linse 220°
E2 Opale - Opal

A 2700K B 3000K C 4000K



L30 Lente 30° - Lens 30° - Linse 30°
L220 Lente 220° - Lens 220° - Linse 220°
E2 Opale - Opal

A 2700K B 3000K C 4000K E RGB

Configura  Configure / Konfigurieren

www.teamitaliailluminazione.it 

 Alimentatore non incluso - Power Supply not included - Netzteil nicht inbegriffen
Alimentatori IP65 a pag. 564-565 - IP65 Drivers p. 564-565 - Netzteil IP65 p. 564-565

* 1600lm effettivi - effective - effektive con - with - mit L220 - 1600lm -15% con - with - mit E2

CODICE COMPLETO • COMPLETE CODE • VOLLSTÄNDIGE CODE

6010DV13 | **B** | **L30**

Codice
Code

Finitura
Finishing
Lackierung

Diffusore
Diffuser
Diffusor



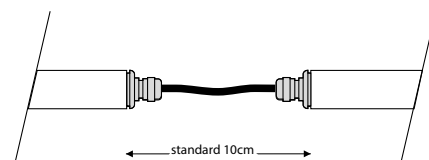

001005A
Servizio collegamento in serie
Line-up connection service
Reihenschaltung Service

56,00 €

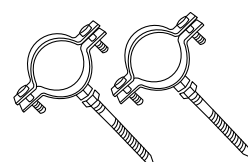

90106010
Coppia Collare antieffrazione
Couple anti-theft collar
Paar Anti-Diebstahl Kragen

14,00 €

ACCIAIO ZINCATO
GALVANIZED STEEL
VERZINKTEM STAHL

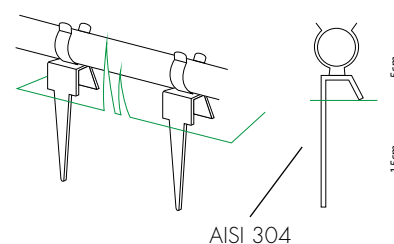

90106008
Coppia picchetti INOX - Orizzontale
Couple INOX stakes for fied - horizontal
Paar INOX Pflöcke für Rasen - horizontal

67,00 €

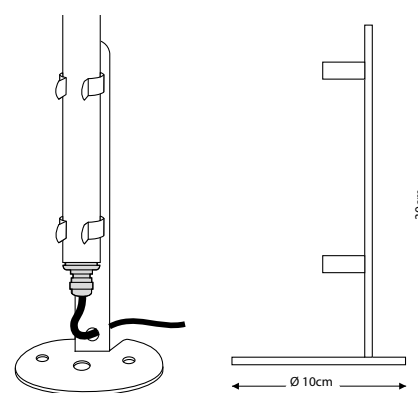

90106009
Coppia picchetti INOX - Verticale
Single INOX stake - vertical
Einzeppflock INOX - vertikal

65,00 €

AISI 304

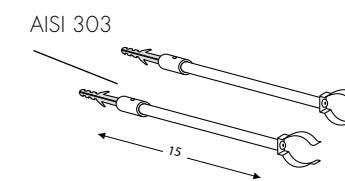

6010DSF15
coppia staffe inox 15cm
Couple of 15cm inox brackets
Paar 15 cm Edelstahlbügel

83,00 €

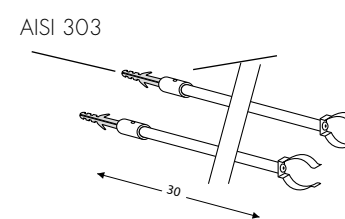

6010DSF30
coppia staffe inox 30cm
Couple of 30 cm inox brackets
Paar 30 cm Edelstahlbügel

114,00 €

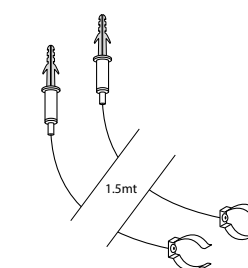

6010DSOSP
Kit sospensione DROP360
Pendant KIT DROP360
Pendel KIT DROP360

50,00 €

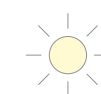

CTT250FEP
Aggiunta cavo 1 mt - 2 poli - fep+gomma Ø5,3
1 mt adding cable - 2 poles - fep+rubber
1 mt Kabel hinzugefügt - 2 Pole - fep+Gummi

14,00 €

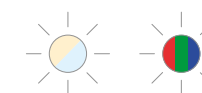

CTT450FEP
Aggiunta cavo 1 mt - 4 poli - fep+gomma Ø5,8
1 mt adding cable - 4 poles - fep+rubber
1 mt Kabel hinzugefügt - 4 Pole - fep+Gummi

25,00 €

Configura  Configure / Konfigurieren

www.teamitaliailluminazione.it 



WET PLUS+

PLAFONE
CEILING LIGHT
DECKENLEUCHE



configurazione standard: / basic configuration: / Standard Konfiguration:

E2 Opale - Opal

C 4000K

GV

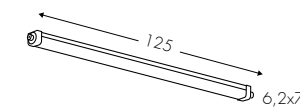

3079BOFGVE2C
3079BDMGVE2C

48W 6500lm* - 220V

134,00 €

DALI (Push) - 50W 5900lm - 220V

249,00 €

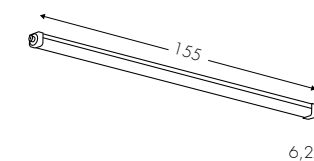

3079COFGVE2C
3079CDMGVE2C

75W 10000lm - 220V

157,00 €

DALI (Push) - 60W 8200lm - 220V

318,00 €

Configura

Configure / Konfigurieren

www.teamitaliailluminazione.it



CODICE COMPLETO DEL PRODOTTO NELLA FOTO
FULL PRODUCT CODE AS SHOWN IN PICTURE - VOLLSTÄNDIGER CODE VOM ARTIKEL IM BILD

3079BOF

Codice
Code

GV

Finitura
Finishing
Lackierung

E2

Diffusore
Diffuser
Diffusor

C

Tonalità
Hue
Farbton

Alimentatore Incorporato - Incorporated Power Supply - Eingebautes Netzteil

* 6500lm effettivi - effective - effektive con - with - mit **E2**

INDEX

SECTION

FAMILY 391

configurazione standard: / basic configuration: / Standard Konfiguration:

24° Ottica - Optic - Optik ● B 3000K

NE

2043AOFNE24B 8W 815lm* - 220V

161,00 €

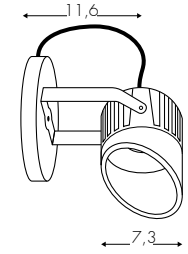

Configura  Configure / Konfigurieren

www.teamitaliailluminazione.it 



A Alimentatore Incorporato - Incorporated Power Supply - Eingebautes Netzteil

* 815lm effettivi - effective - effektive con - with - mit 24°



 **CODICE COMPLETO DEL PRODOTTO NELLA FOTO**
FULL PRODUCT CODE AS SHOWN IN PICTURE - VOLLSTÄNDIGER CODE VOM ARTIKEL IM BILD

2043AOF **NE** **24** **B**

Codice
Code



Finitura
Finishing
Lackierung

Diffusore
Diffuser
Diffusor

Tonalità
Hue
Farbton

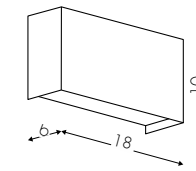
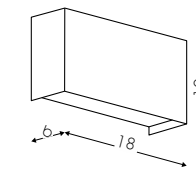

configurazione standard: / basic configuration: / Standard Konfiguration:

E28 Satinato
Frosted - Satiniert B 3000KBV
**2019EOF54BVE28B** 18W 1280lm* - 220V**217,00 €**[Configura](#)  Configure / Konfigurierenwww.teamitaliailluminazione.it **2019FOF54BVE28B** 9W 640lm - 220V**182,00 €**[Configura](#)  Configure / Konfigurierenwww.teamitaliailluminazione.it NE RU
**A** Alimentatore Incorporato - Incorporated Power Supply - Eingebautes Netzteil*1280lm effettivi - effective - effektive con - with - mit **E28** **CODICE COMPLETO DEL PRODOTTO NELLA FOTO**
FULL PRODUCT CODE AS SHOWN IN PICTURE - VOLLSTÄNDIGER CODE VOM ARTIKEL IM BILD**2019EOF54** **NE** **E28** **B**Codice
CodeFinitura
Finishing
LackierungDiffusore
Diffuser
DiffusorTonalità
Hue
Farbton



configurazione standard: / basic configuration: / Standard Konfiguration:

60° Ottica
Optic - Optik

B 3000K

BV

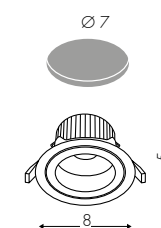

4017QOFBV60B

8W 860lm* - 220V

102,00 €

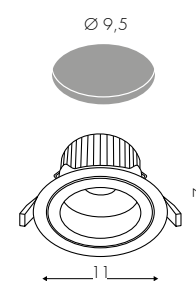

4017ROFBV60B

13W 1320lm - 220V

114,00 €

Configura

Configure / Konfigurieren

www.teamitaliailluminazione.it



C 4000K

Alimentatore Incluso in remoto - Remote Power Supply - Fernspeisung enthalten

* 860lm effettivi - effective - effektive con - with - mit 60°



CODICE COMPLETO DEL PRODOTTO NELLA FOTO
FULL PRODUCT CODE AS SHOWN IN PICTURE - VOLLSTÄNDIGER CODE VOM ARTIKEL IM BILD

4017QOF **BV** **60** **B**

Codice
Code

Finitura
Finishing
Lackierung

Diffusore
Diffuser
Diffusor

Tonalità
Hue
Farbton



configurazione standard: / basic configuration: / Standard Konfiguration:

24° Ottica
Optic - Optik

● B 3000K

AL ■

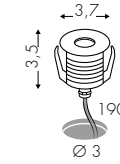

4042AAL24B

1W 120lm* - 350mA 3V

55,00 €

Alimentatore - Power supply - Netzteil

AE006I

OnOff 4W 350mA / 1-3 art.4042A

13,00 €

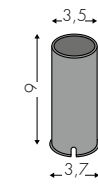

9042A

Controcassa - Outer Casing - Einbauhülse

12,00 €

Configura

Configure / Konfigurieren

www.teamitaliailluminazione.it



Alimentatore non incluso - Power Supply not included - Netzteil nicht inbegriffen

* 120lm effettivi - effective - effektive con - with - mit 24°



CODICE COMPLETO DEL PRODOTTO NELLA FOTO
FULL PRODUCT CODE AS SHOWN IN PICTURE - VOLLSTÄNDIGER CODE VOM ARTIKEL IM BILD

4042A

Codice
Code

AL

Finitura
Finishing
Lackierung

24

Diffusore
Diffuser
Diffusor

B

Tonalità
Hue
Farbton





configurazione standard: / basic configuration: / Standard Konfiguration:

24° Ottica
Optic - Optik ● B 3000K AL

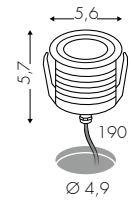

4042BAL24B	3W 360lm - 350mA 9V	82,00 €
Alimentatore - Power supply - Netzteil		
AE006M	OnOff 18W 350mA / 1-5 art.4042B	59,00 €

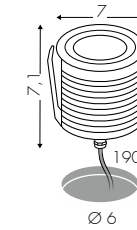

4042CAL24B	7W 840lm* - 350mA 20V	95,00 €
Alimentatore - Power supply - Netzteil		
AE006M	OnOff 18W 350mA / 2 art.4042C	59,00 €

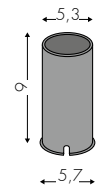

9042B	Controcassa - Outer Casing - Einbauhülse	12,00 €
--------------	--	----------------

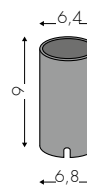

9042C	Controcassa - Outer Casing - Einbauhülse	12,00 €
--------------	--	----------------

Configura Configure / Konfigurieren

www.teamitaliailluminazione.it



Configura Configure / Konfigurieren

www.teamitaliailluminazione.it



CODICE COMPLETO • COMPLETE CODE • VOLLSTÄNDIGE CODE

4042B	AL	24	B
Codice Code	Finitura Finishing Lackierung	Diffusore Diffuser Diffusor	Tonalità Hue Farbton

Alimentatore non incluso - Power Supply not included
Netzteil nicht inbegriffen

* 840lm effettivi - effective - effektive con - with - mit 24°

INDEX

SECTION

FAMILY





configurazione standard: / basic configuration: / Standard Konfiguration:

24° Ottica
Optic - Optik

● B 3000K

AL ■

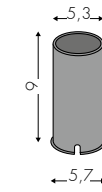
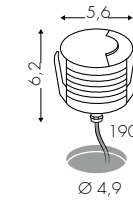

4042DAL24B

3W 360lm* - 350mA 9V

61,00 €

Alimentatore - Power supply - Netzteil

AE006M

OnOff 18W 350mA / 3-5 art.4042D

59,00 €

9042B

Controcassa - Outer Casing - Einbauhülse

12,00 €

Configura

Configure / Konfigurieren

www.teamitaliailluminazione.it



CODICE COMPLETO DEL PRODOTTO NELLA FOTO
FULL PRODUCT CODE AS SHOWN IN PICTURE - VOLLSTÄNDIGER CODE VOM ARTIKEL IM BILD

4042D

Codice
Code

AL

Finitura
Finishing
Lackierung

24

Diffusore
Diffuser
Diffusor

B

Tonalità
Hue
Farbton

Alimentatore non incluso - Power Supply not included - Netzteil nicht inbegriffen

* 360lm effettivi - effective - effektive con - with - mit 24°



configurazione standard: / basic configuration: / Standard Konfiguration:

24° Ottica
Optic - Optik

● B 3000K

AL ■

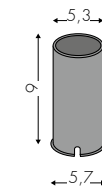
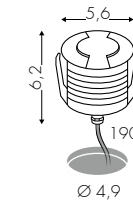

4042EAL24B

3W 360lm* - 350mA 9V

61,00 €

Alimentatore - Power supply - Netzteil

AE006M

OnOff 18W 350mA / 3-5 art.4042E

59,00 €

9042B

Controcassa - Outer Casing - Einbauhülse

12,00 €

Configura

Configure / Konfigurieren

www.teamitaliailluminazione.it



CODICE COMPLETO DEL PRODOTTO NELLA FOTO
FULL PRODUCT CODE AS SHOWN IN PICTURE - VOLLSTÄNDIGER CODE VOM ARTIKEL IM BILD

4042E

Codice
Code

AL

Finitura
Finishing
Lackierung

24

Diffusore
Diffuser
Diffusor

B

Tonalità
Hue
Farbton



Alimentatore non incluso - Power Supply not included - Netzteil nicht inbegriffen

* 360lm effettivi - effective - effektive con - with - mit 24°



configurazione standard: / basic configuration: / Standard Konfiguration:

24° Ottica
Optic - Optik

B 3000K

NE



5043AOFNE24B

8W 815lm* - 220V

125,00 €

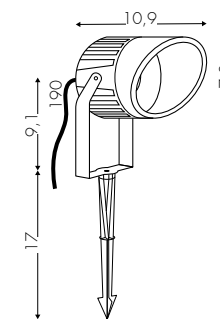

Configura

Configure / Konfigurieren

www.teamitaliailluminazione.it



CODICE COMPLETO DEL PRODOTTO NELLA FOTO
FULL PRODUCT CODE AS SHOWN IN PICTURE - VOLLSTÄNDIGER CODE VOM ARTIKEL IM BILD

5043AOF **NE** **24** **B**

Codice
Code

Finitura
Finishing
Lackierung

Diffusore
Diffuser
Diffusor

Tonalità
Hue
Farbton

Alimentatore Incorporato - Incorporated Power Supply - Eingebautes Netzteil

* 815lm effettivi - effective - effektive con - with - mit 24°

Sistemi modulari
Modular systems
Modulare Systeme

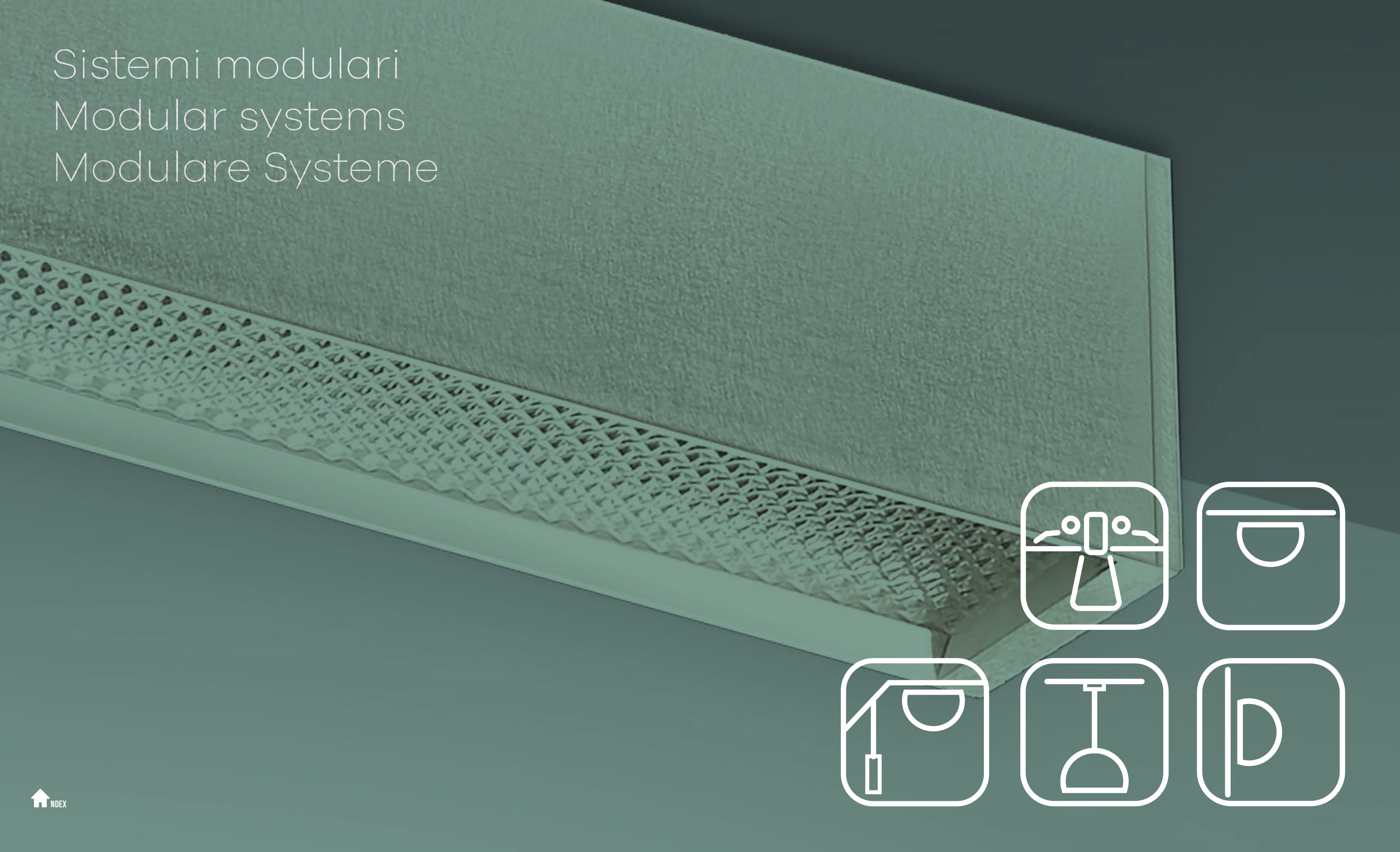

Sospensione/Hanging lamp/Pendelleuchte



Emme24
downlight [1-3m] **421**

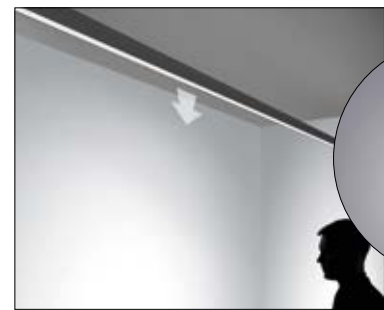

Emme24
downlight [3-10m] **423**



Emme24
downlight giunzione L59x59 **425**



Emme24
downlight curva R46 **425**



M-Eco
up+downlight [1-3m] **427**



M-Eco
up+downlight [3-10m] **429**

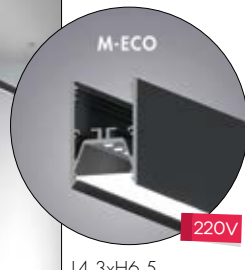

M-Eco
downlight sospensione giunzione "L" **431**



M-Eco
downlight sospensione giunzione "T" **431**



M-Eco
downlight sospensione giunzione "+" **431**



Mirò
up+downlight [1-3m] **435**



Mirò
up+downlight [3-10m] **437**



Mirò
downlight [1-3m] **439**



Mirò
downlight [3-10m] **441**



Mirò
darklight L56/L84/L120 **451**

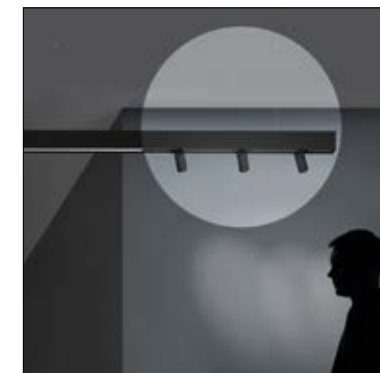

Mirò
orientabile spotlight 2x7W/3x7W /4x7W **443**



Mirò
up+downlight L197/L225/L253 **443**



Mirò
no-light L84/L112/L140 **445**



Mirò
no-light giunzione "L"/"T"/"+" **449**



Mirò
downlight sospensione giunzione "L" **447**



Mirò
downlight sospensione giunzione "T" **447**



Mirò
downlight sospensione giunzione "+" **447**

Plafone/Ceiling/Deckenleuchte



Emme24 453
downlight [1-3mf]



Emme24 455
downlight [3-10mf]

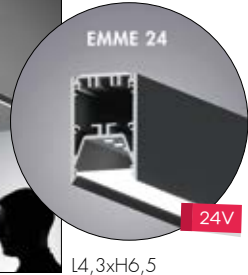

Emme24 455
downlight giunzione L59x59



M-Eco 457
downlight [1-3mf]



M-Eco 459
downlight [3-10mf]

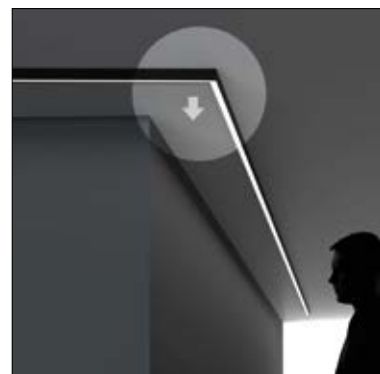
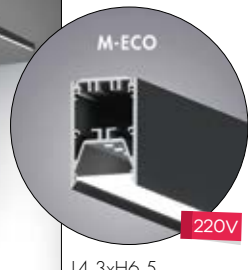

M-Eco 461
downlight sospensione giunzione "L"



M-Eco 461
downlight sospensione giunzione "T"

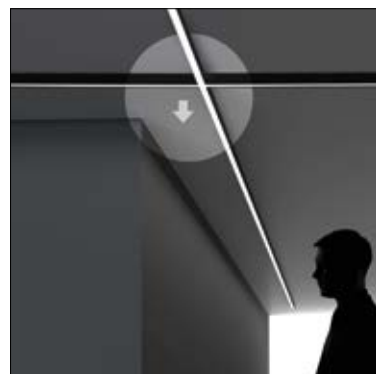

M-Eco 461
downlight sospensione giunzione "+"



Mirò 465
downlight [1-3mf]



Mirò 467
downlight [3-10mf]



Mirò 469
no-light L84/L112/L140

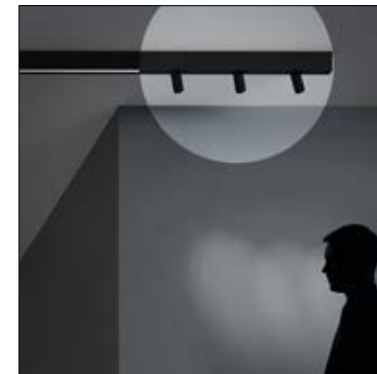

Mirò 471
orientabile spotlight 2x7W/3x7W/4x7W

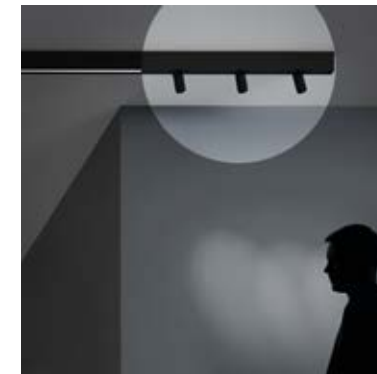

Mirò 471
orientabile spotlight L197/L225/L253



Mirò 477
darklight 56/84/120

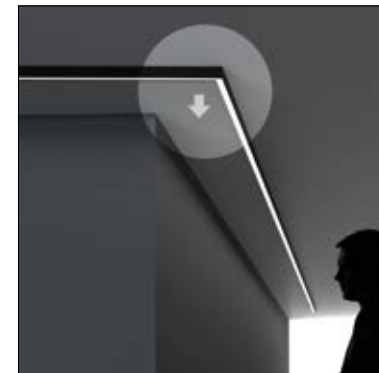

Mirò 473
downlight plafone giunzione "L"

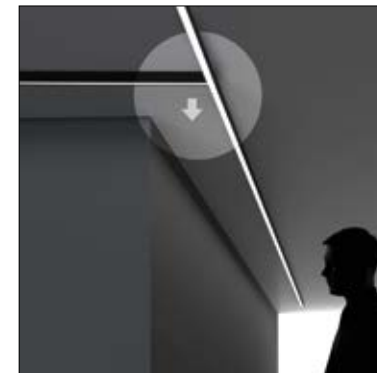

Mirò 473
downlight plafone giunzione "T"

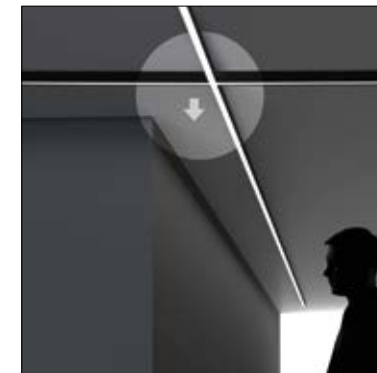

Mirò 473
downlight plafone giunzione "+"



Mirò 475
no-light giunzione "L"/"T"/"+"

Parete/Wall light/Wandeleuchte



Mirò 479-481
up+downlight [2mt-10mt]

Incasso/Recessed/Einbauchte



Emme24 483-485
downlight cartongesso [1-10mt]



Emme24 487
downlight cartongesso L59x59/L56x31
L59x59vert

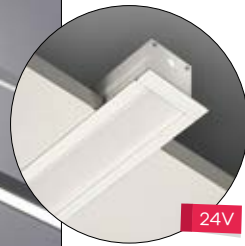

Mirò 489-491
downlight cartongesso [1-10mt]



Mirò 493
downlight cartongesso L59x59/L56.x31
L59x59vert

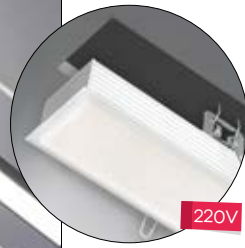

Binario/Track/Elektrofizierte Stromschiene



M-Eco 495
downlight L60/L112/L140/L253



M-Eco 497
downlight L112/L140/L253

EMME 24 EXAMPLES OF COMPOSITION

Gli elementi Emme24 a 24VDC possono essere abbinati liberamente in funzione delle necessità progettuali; la composizione può essere alimentata tramite PowerUnit on-off o dimmerabile opportunamente dimensionata.

Emme24 24VDC elements can be freely combined according to the design needs; the composition can be powered by an appropriately sized on-off PowerUnit or Dimmable.

Die 24VDC Emme24-Elemente können je nach Plan Bedürfnissen frei kombiniert werden; die Zusammensetzung kann durch angemessene On/off oder dimmbares Netzteil bedient werden.

COMPOSIZIONE CODICI DI ACQUISTO CODES COMPOSITION ZUSAMMENSETZUNG DES CODES

1pz 1037MBVE2B
1pz 9037BTFBV

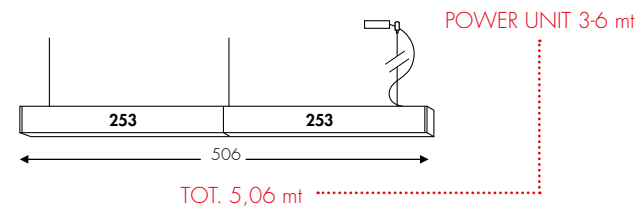

COMPOSIZIONE CODICI DI ACQUISTO CODES COMPOSITION ZUSAMMENSETZUNG DES CODES

1pz 1037LBVE2B
1pz 1037KGABVE2B
1pz 1037EBVE2B
1pz 9037CDM

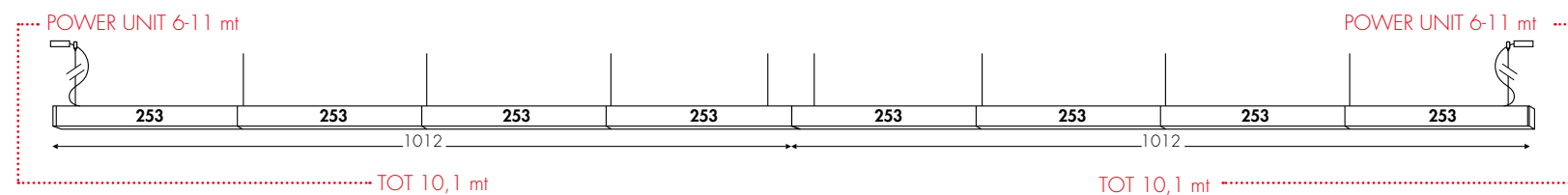
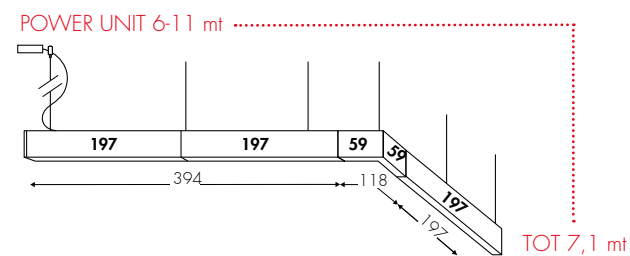

COMPOSIZIONE CODICI DI ACQUISTO CODES COMPOSITION ZUSAMMENSETZUNG DES CODES

2pz 1037RNEE2B
2pz 9037COF

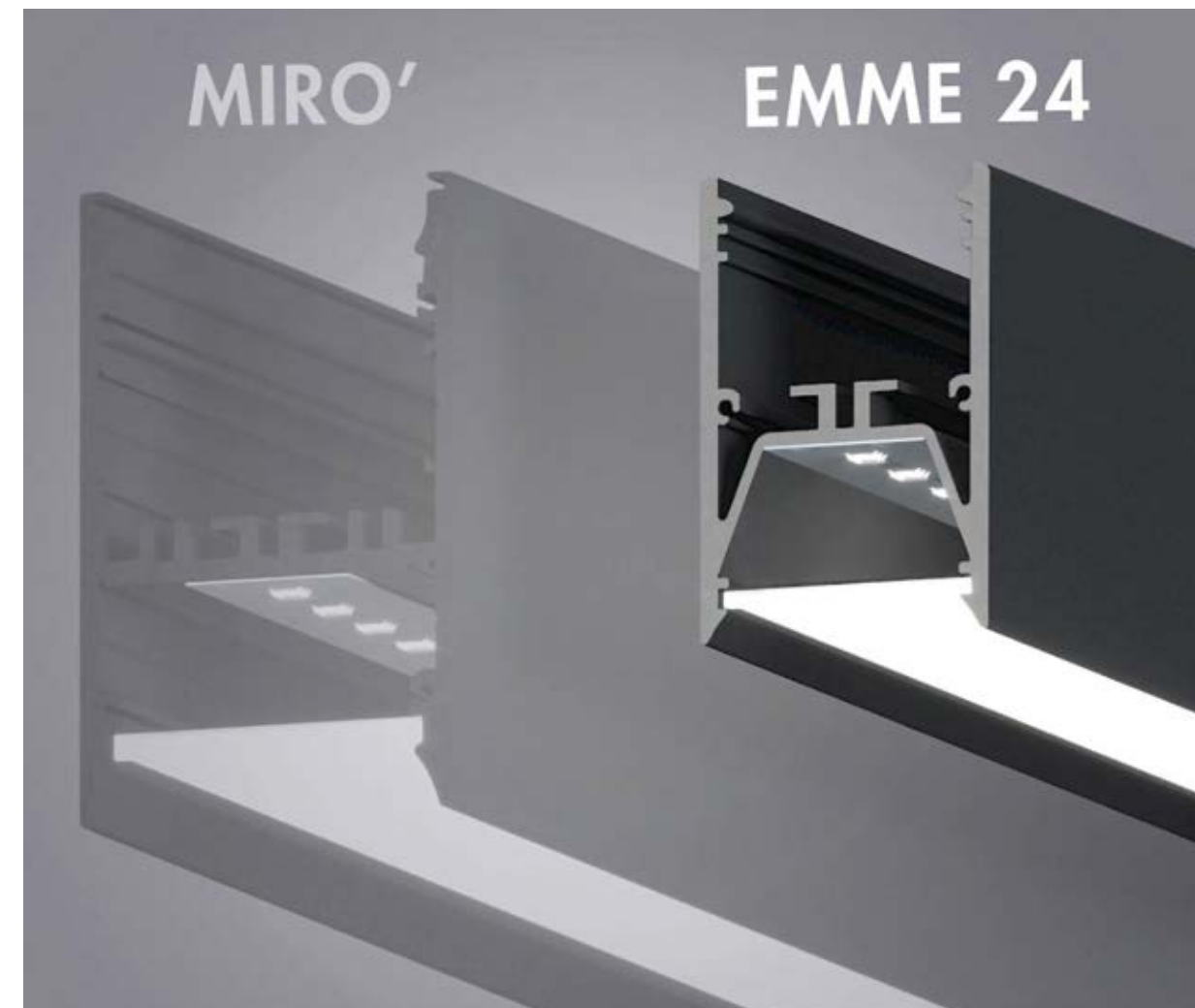

5,5 x H 8,3cm

3160lm/mt
220VAC

Moduli led rigidi/Rigid led modules/
starre LED-Module

Driver incorporato/built-in driver/eingebauter Treiber

4,3 x H 6,5cm

2000lm/mt
24VDC

Moduli led rigidi/Rigid led modules/
starre LED-Module

Driver Onoff - DALI escluso remoto/
Onoff driver - DALI excluded remotely/
Driver Onoff - DALI aus der Ferne ausgeschlossen

EMME 24 DOWNLIGHT (1-3mt)

SOSPENSIONE
SUSPENSION LAMP
PENDELLEUCHTE

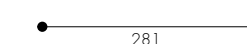
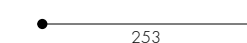
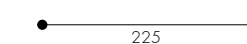
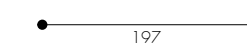
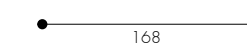
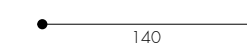
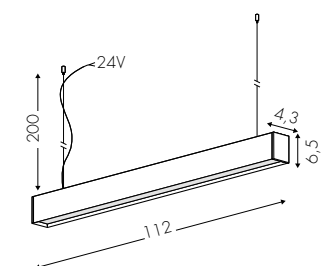

configurazione standard: / basic configuration: / Standard Konfiguration:

E2 Opale - Opal

B 3000K

BV

1037BBVE2B 25W 1910lm* - 24VDC 262,00 €

1037CBVE2B 31W 2385lm - 24VDC 278,00 €

1037DBVE2B 37W 2860lm - 24VDC 299,00 €

1037EBVE2B 44W 3350lm - 24VDC 317,00 €

1037FBVE2B 50W 3830lm - 24VDC 348,00 €

1037GBVE2B 56W 4305lm - 24VDC 370,00 €

1037HBVE2B 62W 4780lm - 24VDC 395,00 €

Configura

Configure / Konfigurieren

www.teamitaliailluminazione.it



E19 UGR<19 Prism

C 4000K

NE

CODICE COMPLETO DEL PRODOTTO NELLA FOTO
FULL PRODUCT CODE AS SHOWN IN PICTURE - VOLLSTÄNDIGER CODE VOM ARTIKEL IM BILD

1037E

Codice
Code

BV

Finitura
Finishing
Lackierung

E2

Diffusore
Diffuser
Diffusor

B

Tonalità
Hue
Farbton

Alimentatore non incluso - Power Supply not included - Netzteil nicht inbegriffen
Alimentatori a pag. 564-565 - Drivers p. 564-565 - Netzteil p. 564-565

* 1910lm effettivi - effective - effektive con - with - mit E2
2240lm effettivi - effective - effektive con - with - mit E19 +17,5%

INDEX

SECTION

FAMILY 421

EMME 24 DOWNLIGHT (3-10mt)

SOSPENSIONE
SUSPENSION LAMP
PENDELLEUCHTE



configurazione standard: / basic configuration: / Standard Konfiguration:

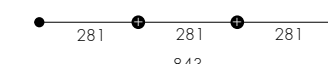
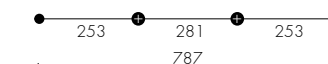
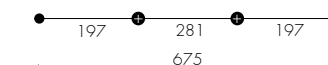
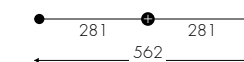
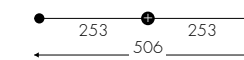
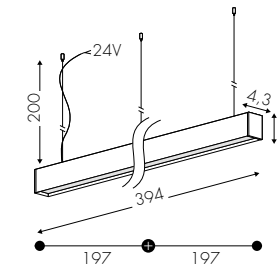

E2 Opale - Opal ● B 3000K BV

1037LBVE2B 87W 6705lm* - 24VDC **700,00 €**

1037MBVE2B 111W 8605lm - 24VDC **760,00 €**

1037NBVE2B 124W 9560lm - 24VDC **873,00 €**

1037OBVE2B 148,5W 11485lm - 24VDC **1.157,00 €**

1037PBVE2B 173W 13380lm - 24VDC **1.298,00 €**

1037QBVE2B 185W 14340lm - 24VDC **1.358,00 €**

1037RBVE2B 223W 17210lm - 24VDC **1.743,00 €**

Configura Configure / Konfigurieren

www.teamitaliailluminazione.it



E19 UGR<19 Prism

C 4000K

NE



CODICE COMPLETO DEL PRODOTTO NELLA FOTO
FULL PRODUCT CODE AS SHOWN IN PICTURE - VOLLSTÄNDIGER CODE VOM ARTIKEL IM BILD

1037KGR **NE** **E2** **B**

Codice
Code

Finitura
Finishing
Lackierung

Diffusore
Diffuser
Diffusor

Tonalità
Hue
Farbton

Alimentatore non incluso - Power Supply not included - Netzteil nicht inbegriffen
Alimentatori a pag. 564-565 - Drivers p. 564-565 - Netzteil p. 564-565

* 6705lm effettivi - effective - effektive con - with - mit **E2**
7880lm effettivi - effective - effektive con - with - mit **E19** **+17,5%**



BV NE

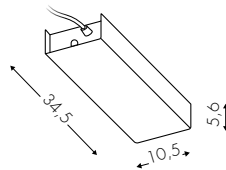

0-3 METRI

9037AOF 75W - 220V
9037ADM DALI (Push) - 75W - 220V
9037ATF 75W - 220V

130,00 €
218,00 €
179,00 €

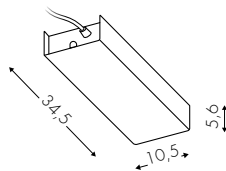

3-6 METRI

9037BOF 150W - 220V
9037BDM DALI (Push) - 150W - 220V
9037BTF 150W - 220V

174,00 €
262,00 €
221,00 €

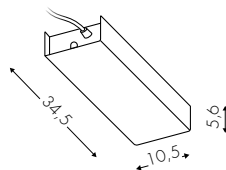

6-11 METRI

9037COF 240W - 220V
9037CDM DALI (Push) - 240W - 220V

228,00 €
318,00 €

Configura Configure / Konfigurieren

www.teamitaliailluminazione.it



A Alimentatore Incorporato - Incorporated Power Supply - Eingebautes Netzteil

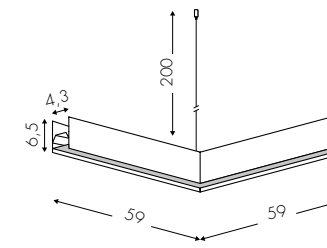

configurazione standard: / basic configuration: / Standard Konfiguration:

E2 Opale - Opal B 3000K

BV

1037KGABVE2B 25W 1905lm* - 24VDC

345,00 €

Configura Configure / Konfigurieren

www.teamitaliailluminazione.it

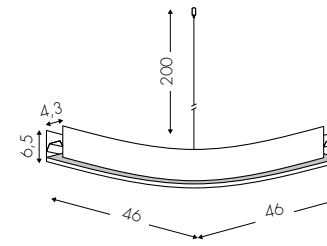

1037KGRBVE2B 18W 1235lm - 24VDC

345,00 €

Configura Configure / Konfigurieren

www.teamitaliailluminazione.it



E19 UGR<19 Prism C 4000K

NE

A Alimentatore non incluso - Power Supply not included - Netzteil nicht inbegriffen
Alimentatori a pag. 564-565 - Drivers p. 564-565 - Netzteil p. 564-565

* 1905lm effettivi - effective - effektive con - with - mit E2
2240lm effettivi - effective - effektive con - with - mit E19 +17,5%



configurazione standard: / basic configuration: / Standard Konfiguration:

E2 Opale - Opal

B 3000K

BV

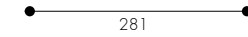
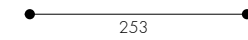
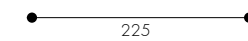
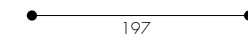
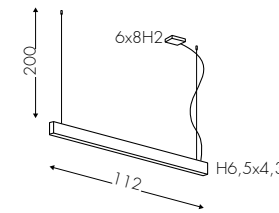

1058BOFBVE2B
1058BDMBVE2B

18W 2025lm* + 8W 1100lm - 220V
DALI (Push) - 18W 2025lm + 8W 1100lm - 220V

304,00 €
365,00 €

1058COFBVE2B
1058CDMBVE2B

22W 2530lm + 8W 1100lm - 220V
DALI (Push) - 22W 2530lm + 8W 1100lm - 220V

329,00 €
388,00 €

1058DOFBVE2B
1058DDMBVE2B

26W 3040lm + 16W 2200lm - 220V
DALI (Push) - 26W 3040lm + 16W 2200lm - 220V

356,00 €
430,00 €

1058EOFBVE2B
1058EDMBVE2B

31W 3540lm + 16W 2200lm - 220V
DALI (Push) - 31W 3540lm + 16W 2200lm - 220V

376,00 €
430,00 €

1058FOFBVE2B
1058FDMBVE2B

34W 4010lm + 16W 2200lm - 220V
DALI (Push) - 34W 4010lm + 16W 2200lm - 220V

424,00 €
498,00 €

1058GOFBVE2B
1058GDMBVE2B

39W 4520lm + 16W 2200lm - 220V
DALI (Push) - 39W 4520lm + 16W 2200lm - 220V

463,00 €
534,00 €

1058HOFBVE2B
1058HDMBVE2B

43W 5080lm + 16W 2200lm - 220V
DALI (Push) - 43W 5080lm + 16W 2200lm - 220V

530,00 €
604,00 €

Configura

Configure / Konfigurieren

www.teamitaliailluminazione.it



E19 UGR<19 Prism

A 2700K C 4000K

NE RU



CODICE COMPLETO DEL PRODOTTO NELLA FOTO
FULL PRODUCT CODE AS SHOWN IN PICTURE - VOLLSTÄNDIGER CODE VOM ARTIKEL IM BILD

1058DOF **NE** **E2** **B**

Codice
Code

Finitura
Finishing
Lackierung

Diffusore
Diffuser
Diffusor

Tonalità
Hue
Farbton

BV NE RU

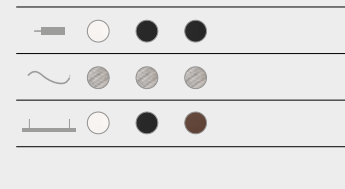

Alimentatore Incorporato - Incorporated Power Supply - Eingebautes Netzteil

* 2025lm effettivi - effective - effektive con - with - mit **E2**
2380lm effettivi - effective - effektive con - with - mit **E19** **+17,5%**



configurazione standard: / basic configuration: / Standard Konfiguration:

E2 Opale - Opal

B 3000K

BV

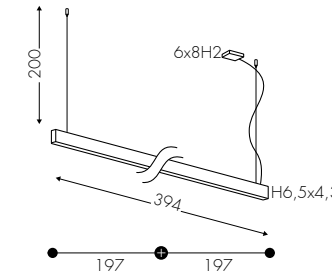

1058LOFBVE2B
1058LDMBVE2B

62W 7080lm* + 32W 4400lm - 220V
DALI (Push) - 62W 7080lm + 32W 4400lm - 220V

766,00 €
877,00 €



1058MOFBVE2B
1058MDMBVE2B

78W 9010lm + 32W 4400lm - 220V
DALI (Push) - 78W 9010lm + 32W 4400lm - 220V

944,00 €
1.088,00 €

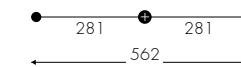

1058NOFBVE2B
1058NDMBVE2B

86W 10155lm + 32W 4400lm - 220V
DALI (Push) - 86W 10155lm + 32W 4400lm - 220V

1.080,00 €
1.231,00 €

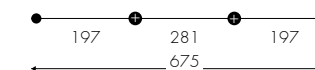

1058OOFBVE2B
1058ODMBVE2B

105W 12160lm + 48W 6600lm - 220V
DALI (Push) - 105W 12160lm + 48W 6600lm - 220V

1.306,00 €
1.492,00 €

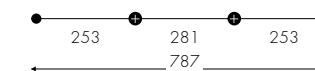

1058POFBVE2B
1058PDMBVE2B

121W 14095lm + 48W 6600lm - 220V
DALI (Push) - 121W 14095lm + 48W 6600lm - 220V

1.483,00 €
1.704,00 €

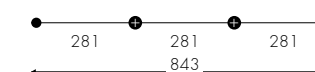

1058QOFBVE2B
1058QDMBVE2B

129W 15230lm + 48W 6600lm - 220V
DALI (Push) - 129W 15230lm + 48W 6600lm - 220V

1.620,00 €
1.847,00 €

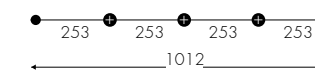

1058ROFBVE2B
1058RDMBVE2B

156W 18030lm + 64W 8800lm - 220V
DALI (Push) - 156W 18030lm + 64W 8800lm - 220V

1.887,00 €
2.176,00 €

Configura

Configure / Konfigurieren

www.teamitaliailluminazione.it



E19 UGR<19 Prism

A 2700K C 4000K

NE RU

CODICE COMPLETO DEL PRODOTTO NELLA FOTO
FULL PRODUCT CODE AS SHOWN IN PICTURE - VOLLSTÄNDIGER CODE VOM ARTIKEL IM BILD

1058OOF **NE** **E2** **B**

Codice
Code

Finitura
Finishing
Lackierung

Diffusore
Diffuser
Diffusor

Tonalità
Hue
Farbton

A Alimentatore Incorporato - Incorporated Power Supply - Eingebautes Netzteil

* 7080lm effettivi - effective - effektive con - with - mit **E2**
8330lm effettivi - effective - effektive con - with - mit **E19** **+17,5%**



configurazione standard: / basic configuration: / Standard Konfiguration:

E2 Opale - Opal

B 3000K

BV

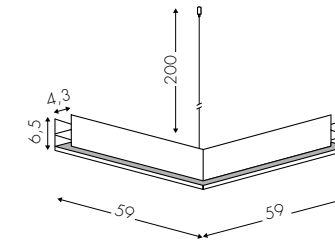

1058KGAOFBVE2B

18W 2025lm* - 220V

454,00 €

1058KGADMBVE2B

DALI (Push) - 18W 2025lm - 220V

520,00 €

Configura

Configure / Konfigurieren

www.teamitaliailluminazione.it

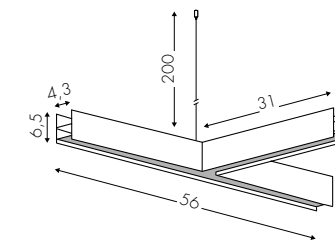

1058KGTDFBVE2B

14W 1575lm - 220V

563,00 €

1058KGTDMBVE2B

DALI (Push) - 14W 1575lm - 220V

634,00 €

Configura

Configure / Konfigurieren

www.teamitaliailluminazione.it

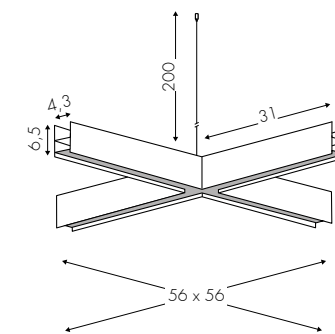

1058KGCDFBVE2B

18W 2025lm - 220V

741,00 €

1058KGCDBVE2B

DALI (Push) - 18W 2025lm - 220V

817,00 €

Configura

Configure / Konfigurieren

www.teamitaliailluminazione.it



E19 UGR<19 Prism

A 2700K C 4000K

NE RU



CODICE COMPLETO DEL PRODOTTO NELLA FOTO
FULL PRODUCT CODE AS SHOWN IN PICTURE - VOLLSTÄNDIGER CODE VOM ARTIKEL IM BILD

1058GAOF **NE** **E2** **B**

Codice
Code

Finitura
Finishing
Lackierung

Diffusore
Diffuser
Diffusor

Tonalità
Hue
Farbton

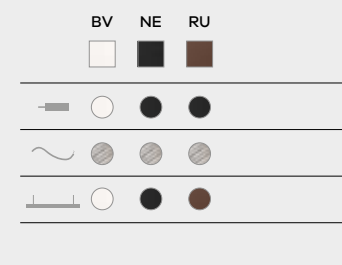

A Alimentatore Incorporato - Incorporated Power Supply - Eingebautes Netzteil

* 2025lm effettivi - effective - effektive con - with - mit **E2**
2380lm effettivi - effective - effektive con - with - mit **E19** **+17,5%**



Up+Downlight

112cm	140cm	168cm	197cm	225cm	253cm	281cm
1030B	1030C	1030D	1030E	1030F	1030G	1030H
394cm	506cm	562cm	675cm	787cm	843cm	1012cm
1030L	1030M	1030N	1030O	1030P	1030Q	1030R



Downlight

112cm	140cm	168cm	197cm	225cm	253cm	281cm
1034B	1034C	1034D	1034E	1034F	1034G	1034H
394cm	506cm	562cm	675cm	787cm	843cm	1012cm
1034L	1034M	1034N	1034O	1034P	1034Q	1034R



Uplight

140cm	168cm	197cm	225cm	253cm	281cm
1035C	1035D	1035E	1035F	1035G	1035H
394cm	506cm	562cm	675cm	787cm	843cm
1035L	1035M	1035N	1035O	1035P	1035Q



Geometrical element downlight

59x59cm	56x31cm	56x56cm
1030KGA	1030KGT	1030KGC



Spotlight

56cm	84cm	112cm	197cm	225cm	253cm
1030S2	1030S3	1030S4	1030S5	1030S6	1030S7

Spotlight+Uplight



Darklight

56cm	84cm	120cm
1046Z	1046A	1046B



No-light

84cm	112cm	140cm
1036A	1036B	1036C



186



Geometrical element No-light

17x17cm	28x17cm	28x28cm
1036KGA	1036KGT	1036KGC

- OF DM
- BV NE
- E2 E19
- 24°
- B 3000K
- C 4000K

- OF DM
- BV NE
- 24°
- B 3000K

- OF DM
- BV NE

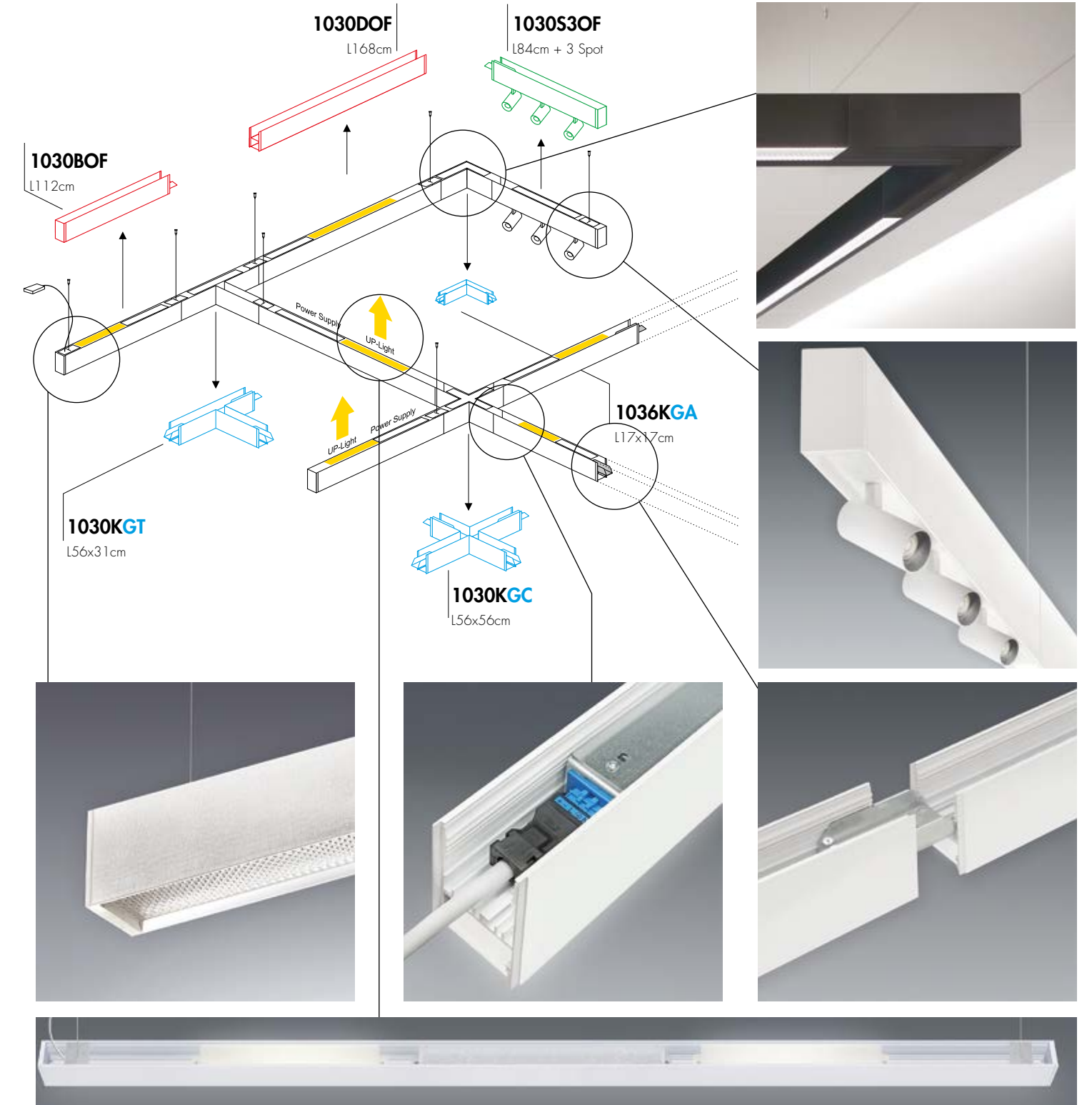



configurazione standard: / basic configuration: / Standard Konfiguration:

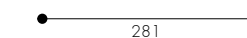
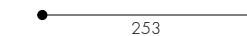
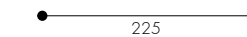
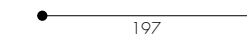
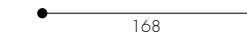
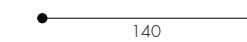
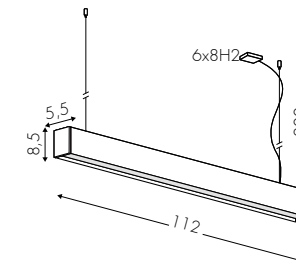

E2 Opale - Opal

B 3000K

BV

1030BOFBVE2B	35W 3010lm* + 18W 2390lm - 220V	397,00 €
1030BDMBVE2B	DALI (Push) - 35W 3010lm + 18W 2390lm - 220V	454,00 €
1030BTFBVE2B	35W 3010lm + 18W 2390lm - 220V	454,00 €
1030COFBVE2B	44W 3765lm + 18W 2390lm - 220V	430,00 €
1030CDMBVE2B	DALI (Push) - 44W 3765lm + 18W 2390lm - 220V	488,00 €
1030CTFBVE2B	44W 3765lm + 18W 2390lm - 220V	488,00 €
1030DOFBVE2B	53W 4515lm + 18W 2390lm - 220V	474,00 €
1030DDMBVE2B	DALI (Push) - 53W 4515lm + 18W 2390lm - 220V	534,00 €
1030DTFBVE2B	53W 4515lm + 18W 2390lm - 220V	534,00 €
1030EOFBVE2B	62W 5265lm + 18W 2390lm - 220V	542,00 €
1030EDMBVE2B	DALI (Push) - 62W 5265lm + 18W 2390lm - 220V	604,00 €
1030ETFBVE2B	62W 5265lm + 18W 2390lm - 220V	604,00 €
1030FOFBVE2B	70W 6020lm + 18W 2390lm - 220V	599,00 €
1030FDMBVE2B	DALI (Push) - 70W 6020lm + 18W 2390lm - 220V	663,00 €
1030FTFBVE2B	70W 6020lm + 18W 2390lm - 220V	663,00 €
1030GOFBVE2B	79W 6775lm + 18W 2390lm - 220V	652,00 €
1030GDMBVE2B	DALI (Push) - 79W 6775lm + 18W 2390lm - 220V	700,00 €
1030GTFBVE2B	79W 6775lm + 18W 2390lm - 220V	700,00 €
1030HOFBVE2B	88W 7525lm + 18W 2390lm - 220V	707,00 €
1030HDMBVE2B	DALI (Push) - 88W 7525lm + 18W 2390lm - 220V	758,00 €
1030HTFBVE2B	88W 7525lm + 18W 2390lm - 220V	758,00 €

Configura 

Configure / Konfigurieren

www.teamitaliailluminazione.it 



E19 UGR<19 Prism

C 4000K

NE

CODICE COMPLETO DEL PRODOTTO NELLA FOTO
FULL PRODUCT CODE AS SHOWN IN PICTURE - VOLLSTÄNDIGER CODE VOM ARTIKEL IM BILD

1030BOF **NE** **E19** **B**

Codice
Code

Finitura
Finishing
Lackierung

Diffusore
Diffuser
Diffusor

Tonalità
Hue
Farbton

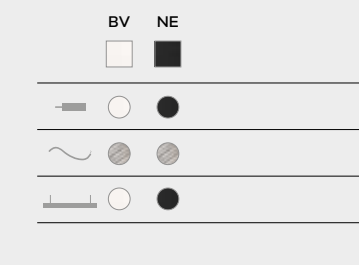

TF Taglio di Fase - Phase-Cut Dimmer - Erhältlich Phasenabschnittdimmer

A Alimentatore Incorporato - Incorporated Power Supply - Eingebautes Netzteil

* 3010lm effettivi - effective - effektive con - with - mit **E2**
3540lm effettivi - effective - effektive con - with - mit **E19** **+17,5%**



configurazione standard: / basic configuration: / Standard Konfiguration:

E2 Opale - Opal

B 3000K

BV

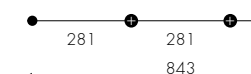
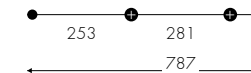
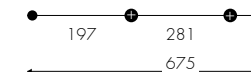
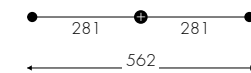
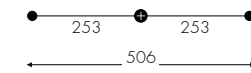
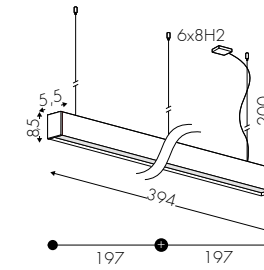

1030LOFBVE2B	123W 10530lm* + 36W 4782lm - 220V	1.139,00 €
1030LDMBVE2B	DALI (Push) - 123W 10530lm + 36W 4782lm - 220V	1.293,00 €
1030LTFBVE2B	123W 10530lm + 36W 4782lm - 220V	1.293,00 €
1030MOFBVE2B	158W 13550lm + 36W 4782lm - 220V	1.312,00 €
1030MDMBVE2B	DALI (Push) - 158W 13550lm + 36W 4782lm - 220V	1.433,00 €
1030MTOFBVE2B	158W 13550lm + 36W 4782lm - 220V	1.433,00 €
1030NOFBVE2B	176W 15050lm + 36W 4782lm - 220V	1.437,00 €
1030NDMBVE2B	DALI (Push) - 176W 15050lm + 36W 4782lm - 220V	1.562,00 €
1030NTFBVE2B	176W 15050lm + 36W 4782lm - 220V	1.562,00 €
1030OOFBVE2B	212W 18060lm + 54W 7173lm - 220V	1.847,00 €
1030ODMBVE2B	DALI (Push) - 212W 18060lm + 54W 7173lm - 220V	2.071,00 €
1030OTFBVE2B	212W 18060lm + 54W 7173lm - 220V	2.071,00 €
1030POFBVE2B	246W 21070lm + 54W 7173lm - 220V	2.141,00 €
1030PDMBVE2B	DALI (Push) - 246W 21070lm + 54W 7173lm - 220V	2.347,00 €
1030PTFBVE2B	246W 21070lm + 54W 7173lm - 220V	2.347,00 €
1030QOFBVE2B	264W 22575lm + 54W 7173lm	2.366,00 €
1030QDMBVE2B	DALI (Push) - 264W 22575lm + 54W 7173lm	2.600,00 €
1030QTFBVE2B	264W 22575lm + 54W 7173lm	2.600,00 €
1030ROFBVE2B	317W 27090lm + 70W 9564lm - 220V	2.952,00 €
1030RDMBVE2B	DALI (Push) - 317W 27090lm + 70W 9564lm - 220V	3.182,00 €
1030RTFBVE2B	317W 27090lm + 70W 9564lm - 220V	3.182,00 €

Configura

Configure / Konfigurieren

www.teamitaliailluminazione.it



E19 UGR<19 Prism

C 4000K

NE

CODICE COMPLETO DEL PRODOTTO NELLA FOTO
FULL PRODUCT CODE AS SHOWN IN PICTURE - VOLLSTÄNDIGER CODE VOM ARTIKEL IM BILD

1030LOF **NE** **E19** **B**

Codice
Code

Finitura
Finishing
Lackierung

Diffusore
Diffuser
Diffusor

Tonalità
Hue
Farbton

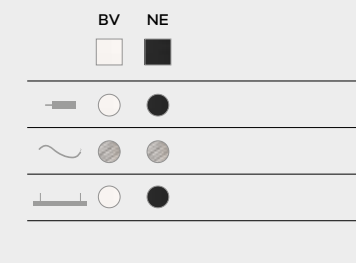

TF Taglio di Fase - Phase-Cut Dimmer - Erhältlich Phasenabschnittdimmer

A Alimentatore Incorporato - Incorporated Power Supply - Eingebautes Netzteil

* 10530lm effettivi - effective - effektive con - with - mit **E2**
12390lm effettivi - effective - effektive con - with - mit **E19** **+17,5%**



configurazione standard: / basic configuration: / Standard Konfiguration:

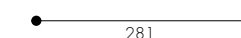
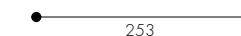
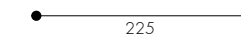
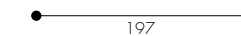
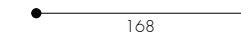
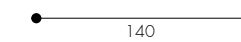
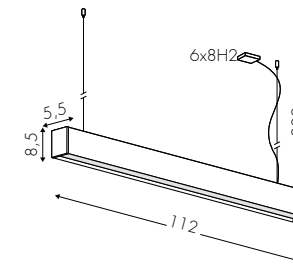

E2 Opale - Opal

B 3000K

BV



1034BOFBVE2B
1034BDMBVE2B

35W 3010lm* - 220V
DALI (Push) - 35W 3010lm - 220V

357,00 €
413,00 €

1034COFBVE2B
1034CDMBVE2B

44W 3765lm - 220V
DALI (Push) - 44W 3765lm - 220V

389,00 €
447,00 €

1034DOFBVE2B
1034DDMBVE2B

53W 4515lm - 220V
DALI (Push) - 53W 4515lm - 220V

434,00 €
493,00 €

1034EOFBVE2B
1034EDMBVE2B

62W 5265lm - 220V
DALI (Push) - 62W 5265lm - 220V

461,00 €
522,00 €

1034FOFBVE2B
1034FDMBVE2B

70W 6020lm - 220V
DALI (Push) - 70W 6020lm - 220V

517,00 €
580,00 €

1034GOFBVE2B
1034GDMBVE2B

79W 6775lm - 220V
DALI (Push) - 79W 6775lm - 220V

569,00 €
616,00 €

1034HOFBVE2B
1034HDMBVE2B

88W 7525lm - 220V
DALI (Push) - 88W 7525lm - 220V

623,00 €
672,00 €

Configura

Configure / Konfigurieren

www.teamitaliailluminazione.it



E19 UGR<19 Prism

C 4000K

NE



CODICE COMPLETO DEL PRODOTTO NELLA FOTO
FULL PRODUCT CODE AS SHOWN IN PICTURE - VOLLSTÄNDIGER CODE VOM ARTIKEL IM BILD

1034COF

BV

E19

C

Codice
Code

Finitura
Finishing
Lackierung

Diffusore
Diffuser
Diffusor

Tonalità
Hue
Farbton

BV



NE

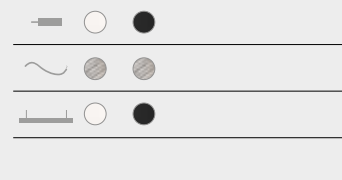

A Alimentatore Incorporato - Incorporated Power Supply - Eingebautes Netzteil

* 3010lm effettivi - effective - effektive con - with - mit **E2**
3540lm effettivi - effective - effektive con - with - mit **E19** **+17,5%**



configurazione standard: / basic configuration: / Standard Konfiguration:

E2 Opale - Opal

B 3000K

BV

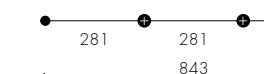
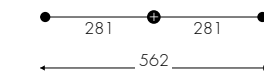
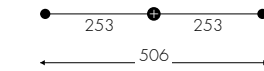
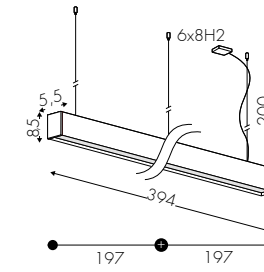

1034LOFBVE2B
1034LDMBVE2B

123W 10530lm* - 220V
DALI (Push) - 123W 10530lm - 220V

1.001,00 €
1.150,00 €

1034MOFBVE2B
1034MDMBVE2B

158W 13550lm - 220V
DALI (Push) - 158W 13550lm - 220V

1.174,00 €
1.291,00 €

1034NOFBVE2B
1034NDMBVE2B

176W 15050lm - 220V
DALI (Push) - 176W 15050lm - 220V

1.298,00 €
1.419,00 €

1034OOFBVE2B
1034ODMBVE2B

212W 18060lm - 220V
DALI (Push) - 212W 18060lm - 220V

1.635,00 €
1.853,00 €

1034POFBVE2B
1034PDMBVE2B

246W 21070lm - 220V
DALI (Push) - 246W 21070lm - 220V

1.923,00 €
2.122,00 €

1034QOFBVE2B
1034QDMBVE2B

264W 22575lm - 220V
DALI (Push) - 264W 22575lm - 220V

2.059,00 €
2.264,00 €

1034ROFBVE2B
1034RDMBVE2B

317W 27090lm - 220V
DALI (Push) - 317W 27090lm - 220V

2.593,00 €
2.848,00 €

Configura

Configure / Konfigurieren

www.teamitaliailluminazione.it



E19 UGR<19 Prism

C 4000K

NE



CODICE COMPLETO DEL PRODOTTO NELLA FOTO
FULL PRODUCT CODE AS SHOWN IN PICTURE - VOLLSTÄNDIGER CODE VOM ARTIKEL IM BILD

1034POF **NE** **E2** **B**

Codice
Code

Finitura
Finishing
Lackierung

Diffusore
Diffuser
Diffusor

Tonalità
Hue
Farbton

BV



NE

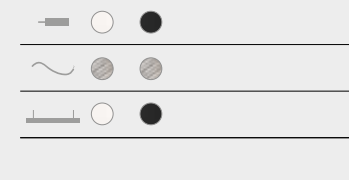

A Alimentatore Incorporato - Incorporated Power Supply - Eingebautes Netzteil

* 10530lm effettivi - effective - effektive con - with - mit **E2**
12390lm effettivi - effective - effektive con - with - mit **E19** **+17,5%**



MIRÓ

SPOTLIGHT

SOSPENSIONE
SUSPENSION LAMP
PENDELLEUCHE



configurazione standard: / basic configuration: / Standard Konfiguration:

24° Ottica - Optic - Optik ● B 3000K

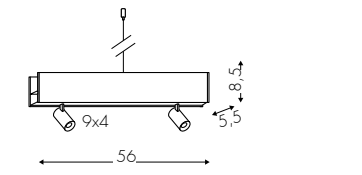

1030S2OFBV24B Spot 2x7W 2x680lm* - 220V 399,00 €
1030S2DMBV24B DALI (Push) - Spot 2x7W 2x680lm - 220V 506,00 €

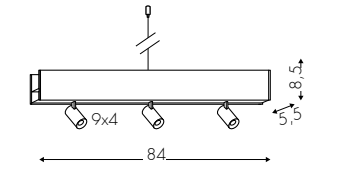

1030S3OFBV24B Spot 3x7W 3x680lm - 220V 515,00 €
1030S3DMBV24B DALI (Push) - Spot 3x7W 3x680lm - 220V 633,00 €

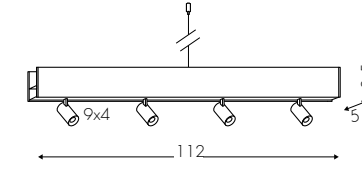

1030S4OFBV24B Spot 4x7W 4x680lm - 220V 608,00 €
1030S4DMBV24B DALI (Push) - Spot 4x7W 4x680lm - 220V 726,00 €

Configura Configure / Konfigurieren

www.teamitaliailluminazione.it

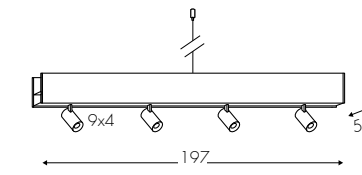

1030S5OFBV24B Spot 4x7W 4x680lm + 18W 2390lm - 220V 1.013,00 €
1030S5DMBV24B DALI (Push) - Spot 4x7W 4x680lm + 18W 2390lm - 220V 1.118,00 €

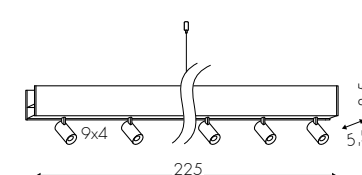

1030S6OFBV24B Spot 5x7W 5x680lm + 18W 2390lm - 220V 1.389,00 €
1030S6DMBV24B DALI (Push) - Spot 5x7W 5x680lm + 18W 2390lm - 220V 1.550,00 €

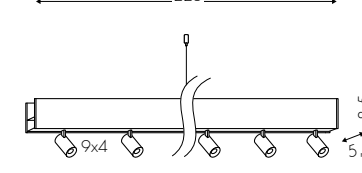

1030S7OFBV24B Spot 5x7W 5x680lm + 18W 2390lm - 220V 1.505,00 €
1030S7DMBV24B DALI (Push) - Spot 5x7W 5x680lm + 18W 2390lm - 220V 1.669,00 €

Configura Configure / Konfigurieren

www.teamitaliailluminazione.it



○ C 4000K



CODICE COMPLETO DEL PRODOTTO NELLA FOTO
FULL PRODUCT CODE AS SHOWN IN PICTURE - VOLLSTÄNDIGER CODE VOM ARTIKEL IM BILD

1030S7OF **NE** **24** **B**

Codice
Code

Finitura
Finishing
Lackierung

Diffusore
Diffuser
Diffusor

Tonalità
Hue
Farbton

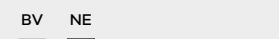

A Alimentatore Incorporato - Incorporated Power Supply - Eingebautes Netzteil

* 2x680lm effettivi - effective - effektive con - with - mit 24°



configurazione standard: / basic configuration: / Standard Konfiguration:

BV

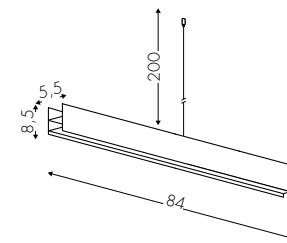

1036AOFBV*
1036ADMBV

Modulo non luminoso - No light element - Pendelleuchte Blindabdeckung
Modulo non luminoso - No light element - Pendelleuchte Blindabdeckung

180,00 €
191,00 €

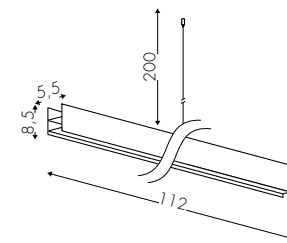

1036BOFBV*
1036BDMBV

Modulo non luminoso - No light element - Pendelleuchte Blindabdeckung
Modulo non luminoso - No light element - Pendelleuchte Blindabdeckung

193,00 €
212,00 €

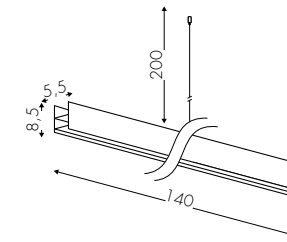

1036COFBV*
1036CDMBV

Modulo non luminoso - No light element - Pendelleuchte Blindabdeckung
Modulo non luminoso - No light element - Pendelleuchte Blindabdeckung

209,00 €
225,00 €

Configura 

Configure / Konfigurieren

www.teamitaliailluminazione.it 



BV NE

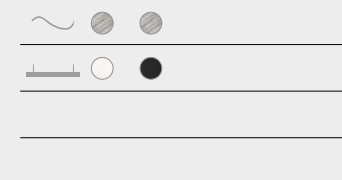

* Compatibile con moduli TF - Compatible with TF module - Kompatibel mit Typ A Modul

 CODICE COMPLETO DEL PRODOTTO NELLA FOTO
FULL PRODUCT CODE AS SHOWN IN PICTURE - VOLLSTÄNDIGER CODE VOM ARTIKEL IM BILD

1036AOF **NE**

Codice
Code

Finitura
Finishing
Lackierung



configurazione standard: / basic configuration: / Standard Konfiguration:

E2 Opale - Opal

B 3000K

BV

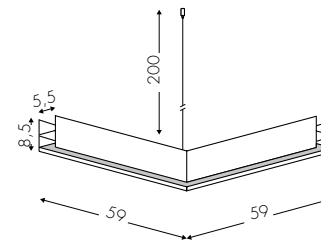

- | | | |
|-----------------------|---------------------------------|-----------------|
| 1030KGAOFBVE2B | 35W 3029lm* - 220V | 454,00 € |
| 1030KGADMBVE2B | DALI (Push) - 35W 3029lm - 220V | 520,00 € |
| 1030KATFBVE2B | 35W 3029lm - 220V | 520,00 € |

Configura Configure / Konfigurieren

www.teamitaliailluminazione.it

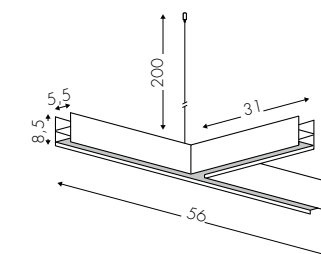

- | | | |
|-----------------------|---------------------------------|-----------------|
| 1030KGTOFBVE2B | 26W 2277lm - 220V | 563,00 € |
| 1030KGTDMBVE2B | DALI (Push) - 26W 2277lm - 220V | 634,00 € |
| 1030KGTTFBVE2B | 26W 2277lm - 220V | 634,00 € |

Configura Configure / Konfigurieren

www.teamitaliailluminazione.it

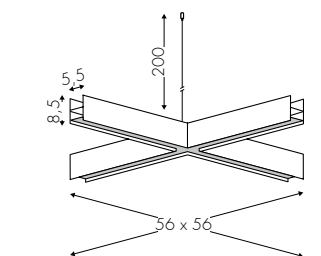

- | | | |
|------------------------|---------------------------------|-----------------|
| 1030KGC OFBVE2B | 35W 3029lm - 220V | 741,00 € |
| 1030KGC DMBVE2B | DALI (Push) - 35W 3029lm - 220V | 817,00 € |
| 1030KGCTFBVE2B | 35W 3029lm - 220V | 817,00 € |

Configura Configure / Konfigurieren

www.teamitaliailluminazione.it



E19 UGR<19 Prism

C 4000K

NE



CODICE COMPLETO DEL PRODOTTO NELLA FOTO
FULL PRODUCT CODE AS SHOWN IN PICTURE - VOLLSTÄNDIGER CODE VOM ARTIKEL IM BILD

1030KGAOF **NE** **E19** **B**

Codice
Code

Finitura
Finishing
Lackierung

Diffusore
Diffuser
Diffusor

Tonalità
Hue
Farbton

BV



NE



TF Taglio di Fase - Phase-Cut Dimmer - Erhältlich Phasenabschnittdimmer

A Alimentatore Incorporato - Incorporated Power Supply - Eingebautes Netzteil

* 3029lm effettivi - effective - effektive con - with - mit **E2**
3540lm effettivi - effective - effektive con - with - mit **E19** **+17,5%**



configurazione standard: / basic configuration: / Standard Konfiguration:

BV

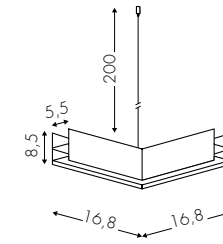

1036KGAOFBV*
1036KGADMBV

Modulo non luminoso - No light element - Pendelleuchte Blindabdeckung
Modulo non luminoso - No light element - Pendelleuchte Blindabdeckung

253,00 €
277,00 €

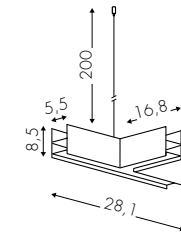

1036KGTOFBV*
1036KGTDMBV

Modulo non luminoso - No light element - Pendelleuchte Blindabdeckung
Modulo non luminoso - No light element - Pendelleuchte Blindabdeckung

273,00 €
297,00 €

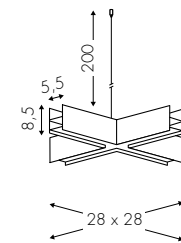

1036KGC OFBV*
1036KGC DMBV

Modulo non luminoso - No light element - Pendelleuchte Blindabdeckung
Modulo non luminoso - No light element - Pendelleuchte Blindabdeckung

294,00 €
319,00 €

Configura

Configure / Konfigurieren

www.teamitaliailluminazione.it

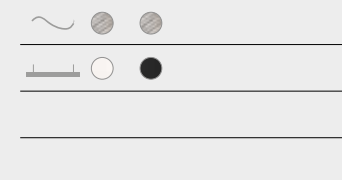

* Compatibile con modulo **TF** - Compatible with **TF** module - Kompatibel mit **TF** Modul

CODICE COMPLETO DEL PRODOTTO NELLA FOTO
FULL PRODUCT CODE AS SHOWN IN PICTURE - VOLLSTÄNDIGER CODE VOM ARTIKEL IM BILD

1036KGAOF **NE**

Codice
Code

Finitura
Finishing
Lackierung



configurazione standard: / basic configuration: / Standard Konfiguration:

24° Ottica - Optic - Optik ● B 3000K BV

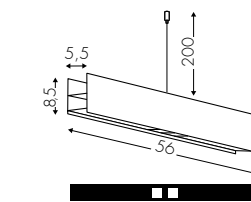

1046ZOFBV24B	9W 900lm* - 220V	423,00 €
1046ZDMBV24B	DALI (Push) - 9W 900lm - 220V	531,00 €

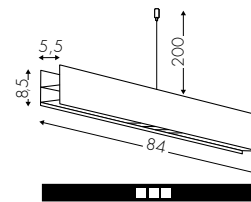

1046AOFBV24B	13W 1500lm - 220V	538,00 €
1046ADMV24B	DALI (Push) - 13W 1500lm - 220V	656,00 €

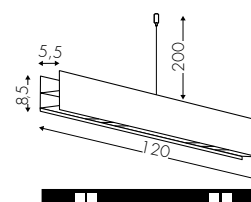

1046BOFBV24B	2x9W 2x900lm - 220V	643,00 €
1046BDMV24B	DALI (Push) - 2x9W 2x900lm - 220V	763,00 €

Configura  Configure / Konfigurieren

www.teamitaliailluminazione.it 



NE

 **CODICE COMPLETO DEL PRODOTTO NELLA FOTO**
FULL PRODUCT CODE AS SHOWN IN PICTURE - VOLLSTÄNDIGER CODE VOM ARTIKEL IM BILD

1046BOF **BV** **24** **B**

Codice Code	Finitura Finishing Lackierung	Diffusore Diffuser Diffusor	Tonalità Hue Farbton
----------------	-------------------------------------	-----------------------------------	----------------------------

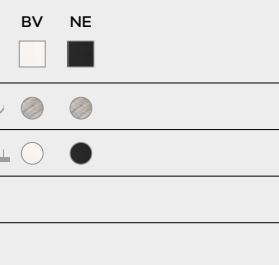

A Alimentatore Incorporato - Incorporated Power Supply - Eingebautes Netzteil

* 900lm effettivi - effective - effektive con - with - mit 24°

EMME 24 DOWNLIGHT (1-3mt)

PLAFONE
CEILING LIGHT
DECKENLEUCHTE

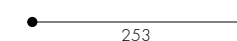
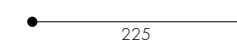
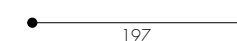
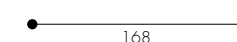
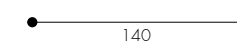
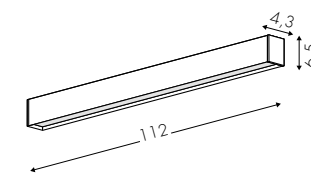

configurazione standard: / basic configuration: / Standard Konfiguration:

E2 Opale - Opal

B 3000K

BV

3037BBVE2B 25W 1910lm* - 24VDC **285,00 €**

3037CBVE2B 31W 2385lm - 24VDC **301,00 €**

3037DBVE2B 37W 2860lm - 24VDC **322,00 €**

3037EBVE2B 44W 3350lm - 24VDC **340,00 €**

3037FBVE2B 50W 3830lm - 24VDC **370,00 €**

3037GBVE2B 56W 4305lm - 24VDC **394,00 €**

3037HBVE2B 62W 4780lm - 24VDC **421,00 €**

Configura

Configure / Konfigurieren

www.teamitaliailluminazione.it



E19 UGR<19 Prism

C 4000K

NE

CODICE COMPLETO DEL PRODOTTO NELLA FOTO
FULL PRODUCT CODE AS SHOWN IN PICTURE - VOLLSTÄNDIGER CODE VOM ARTIKEL IM BILD

3037D

Codice
Code

NE

Finitura
Finishing
Lackierung

E19

Diffusore
Diffuser
Diffusor

B

Tonalità
Hue
Farbton

Alimentatore non incluso - Power Supply not included - Netzteil nicht inbegriffen
Alimentatori a pag. 564-565 - Drivers p. 564-565 - Netzteil p. 564-565

* 1910lm effettivi - effective - effektive con - with - mit **E2**
2240lm effettivi - effective - effektive con - with - mit **E19** **+17,5%**

INDEX

SECTION

FAMILY 453

EMME 24 DOWNLIGHT (3-10mt)

PLAFONE
CEILING LIGHT
DECKENLEUCHTE



configurazione standard: / basic configuration: / Standard Konfiguration:

E2 Opale - Opal

● B 3000K

BV

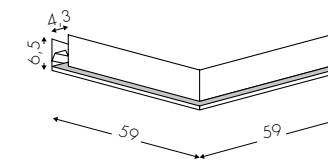
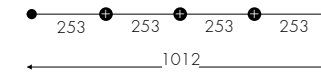
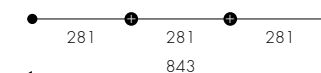
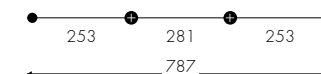
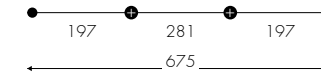
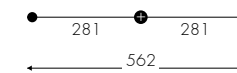
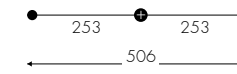
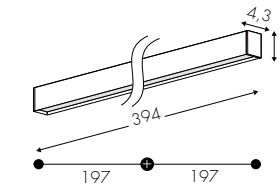

3037LBVE2B

87W 6705lm* - 24VDC

743,00 €

3037MBVE2B

111W 8605lm - 24VDC

784,00 €

3037NBVE2B

124W 9560lm - 24VDC

896,00 €

3037OBVE2B

148,5W 11485lm - 24VDC

1.179,00 €

3037PBVE2B

173W 13380lm - 24VDC

1.310,00 €

3037QBVE2B

185W 14340lm - 24VDC

1.345,00 €

3037RBVE2B

223W 17210lm - 24VDC

1.774,00 €

Configura

Configure / Konfigurieren

www.teamitaliailluminazione.it

3037KGA

25W 1905lm - 24VDC

352,00 €

Configura

Configure / Konfigurieren

www.teamitaliailluminazione.it

E19 UGR<19 Prism

○ C 4000K

NE

Alimentatore non incluso - Power Supply not included - Netzteil nicht inbegriffen

Alimentatori a pag. 564-565 - Drivers p. 564-565 - Netzteil p. 564-565

* 6705lm effettivi - effective - effektive con - with - mit E2

7880lm effettivi - effective - effektive con - with - mit E19 +17,5%

CODICE COMPLETO DEL PRODOTTO NELLA FOTO
FULL PRODUCT CODE AS SHOWN IN PICTURE - VOLLSTÄNDIGER CODE VOM ARTIKEL IM BILD

3037L

Codice
Code

NE

Finitura
Finishing
Lackierung

E2

Diffusore
Diffuser
Diffusor

B

Tonalità
Hue
Farbton

configurazione standard: / basic configuration: / Standard Konfiguration:

E2 Opale - Opal ● B 3000K

BV

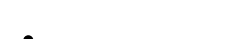
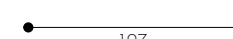
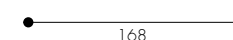
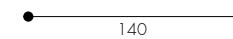
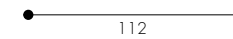
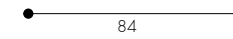
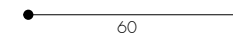
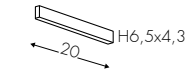

3058TOFBVE2B	7,5W 850lm* - 220V	136,00 €
3058TTFBVE2B	7,5W 850lm - 220V	162,00 €
3058UOFBVE2B	9W 1010lm - 220V	236,00 €
3058UTFBVE2B	9W 1010lm - 220V	265,00 €
3058AOFBVE2B	13,5W 1520lm - 220V	329,00 €
3058ADMBVE2B	DALI (Push) - 13,5W 1520lm - 220V	374,00 €
3058BOFBVE2B	18W 2025lm - 220V	336,00 €
3058BDMBVE2B	DALI (Push) - 18W 2025lm - 220V	391,00 €
3058COFBVE2B	22W 2530lm - 220V	379,00 €
3058CDMBVE2B	DALI (Push) - 22W 2530lm - 220V	435,00 €
3058DOFBVE2B	27W 3040lm - 220V	395,00 €
3058DDMBVE2B	DALI (Push) - 27W 3040lm - 220V	464,00 €
3058EOFBVE2B	31W 3540lm - 220V	411,00 €
3058EDMBVE2B	DALI (Push) - 31W 3540lm - 220V	469,00 €
3058FOFBVE2B	36W 4010lm - 220V	411,00 €
3058FDMBVE2B	DALI (Push) - 36W 4010lm - 220V	469,00 €
3058GOFBVE2B	39W 4510lm - 220V	566,00 €
3058GDMBVE2B	DALI (Push) - 39W 4510lm - 220V	641,00 €
3058HOFBVE2B	45W 5080lm - 220V	613,00 €
3058HDMBVE2B	DALI (Push) - 45W 5080lm - 220V	660,00 €

Configura  Configure / Konfigurieren

www.teamitaliailluminazione.it 



E19 UGR<19 Prism ● A 2700K ○ C 4000K

NE RU 

TF Taglio di Fase - Phase-Cut Dimmer - Erhältlich Phasenabschnittdimmer

A Alimentatore Incorporato - Incorporated Power Supply - Eingebautes Netzteil

* 850lm effettivi - effective - effektive con - with - mit **E2**
1000lm effettivi - effective - effektive con - with - mit **E19** ↻ +17,5%



M-ECO

DOWNLIGHT (3-10mt)

PLAFONE
CEILING LIGHT
DECKENLEUCHTE



configurazione standard: / basic configuration: / Standard Konfiguration:

E2 Opale - Opal

B 3000K

BV

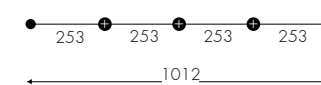
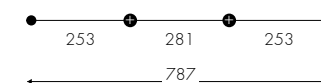
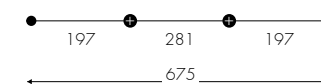
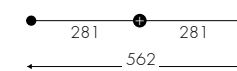
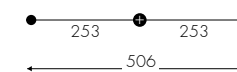
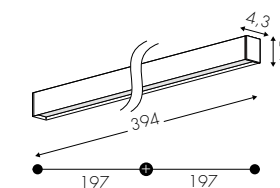

3058LOFBVE2B
3058LDMBVE2B

62W 7080lm* - 220V
DALI (Push) - 62W 7080lm - 220V

822,00 €
937,00 €

3058MOFBVE2B
3058MDMBVE2B

78W 9010lm - 220V
DALI (Push) - 78W 9010lm - 220V

1.132,00 €
1.281,00 €

3058NOFBVE2B
3058NDMBVE2B

90W 10155lm - 220V
DALI (Push) - 90W 10155lm - 220V

1.225,00 €
1.320,00 €

3058OOFBVE2B
3058ODMBVE2B

107W 12160lm - 220V
DALI (Push) - 107W 12160lm - 220V

1.435,00 €
1.597,00 €

3058POFBVE2B
3058PDMBVE2B

123W 14095lm - 220V
DALI (Push) - 123W 14095lm - 220V

1.744,00 €
1.941,00 €

3058QOFBVE2B
3058QDMBVE2B

135W 15230lm - 220V
DALI (Push) - 135W 15230lm - 220V

1.838,80 €
1.979,00 €

3058ROFBVE2B
3058RDMBVE2B

156W 18030lm - 220V
DALI (Push) - 156W 18030lm - 220V

2.195,00 €
2.561,00 €

Configura

Configure / Konfigurieren

www.teamitaliailluminazione.it



E19 UGR<19 Prism

A 2700K C 4000K

NE RU



CODICE COMPLETO DEL PRODOTTO NELLA FOTO
FULL PRODUCT CODE AS SHOWN IN PICTURE - VOLLSTÄNDIGER CODE VOM ARTIKEL IM BILD

3058LOF **NE** **E2** **B**

Codice
Code

Finitura
Finishing
Lackierung

Diffusore
Diffuser
Diffusor

Tonalità
Hue
Farbton

Alimentatore Incorporato - Incorporated Power Supply - Eingebautes Netzteil

* 7080lm effettivi - effective - effektive con - with - mit **E2**
8330lm effettivi - effective - effektive con - with - mit **E19** **+17,5%**

INDEX

SECTION

FAMILY 459



configurazione standard: / basic configuration: / Standard Konfiguration:

E2 Opale - Opal

● B 3000K

BV

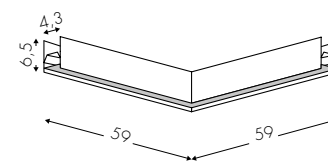

3058KGAOFBVE2B

18W 2025lm* - 220V

430,00 €

3058KGADMBVE2B

DALI (Push) - 18W 2025lm - 220V

495,00 €

Configura

Configure / Konfigurieren

www.teamitaliailluminazione.it

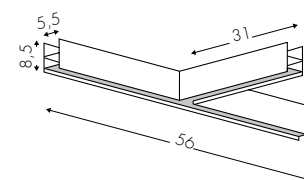

3058KGTFOBVE2B

14W 1575lm - 220V

535,00 €

3058KGTDMBVE2B

DALI (Push) - 14W 1575lm - 220V

602,00 €

Configura

Configure / Konfigurieren

www.teamitaliailluminazione.it

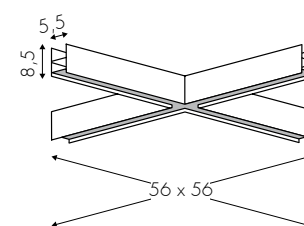

3058KGCFOBVE2B

18W 2025lm - 220V

705,00 €

3058KGCDMBVE2B

DALI (Push) - 18W 2025lm - 220V

775,00 €

Configura

Configure / Konfigurieren

www.teamitaliailluminazione.it



E19 UGR<19 Prism

● A 2700K ○ C 4000K

NE RU

A Alimentatore Incorporato - Incorporated Power Supply - Eingebautes Netzteil

* 2025lm effettivi - effective - effektive con - with - mit **E2**
2380lm effettivi - effective - effektive con - with - mit **E19** ↻ +17,5%

CODICE COMPLETO DEL PRODOTTO NELLA FOTO
FULL PRODUCT CODE AS SHOWN IN PICTURE - VOLLSTÄNDIGER CODE VOM ARTIKEL IM BILD

3058KGAOF **BV** **E2** **B**

Codice
Code

Finitura
Finishing
Lackierung

Diffusore
Diffuser
Diffusor

Tonalità
Hue
Farbton



Downlight

84cm	112cm	140cm	168cm	197cm	225cm	253cm	281cm
3030A	3030B	3030C	3030D	3030E	3030F	3030G	3030H
394cm	506cm	562cm	675cm	787cm	843cm	1012cm	
3030L	3030M	3030N	3030O	3030P	3030Q	3030R	



Spotlight

56cm	84cm	112cm	197cm	225cm	253cm
3030S2	3030S3	3030S4	3030S5	3030S6	3030S7



Geometrical element downlight

59*59cm	56*31cm	56*56cm
3030KGA	3030KGT	3030KGC



Darklight

56cm	84cm	120cm
3046Z	3046A	3046B



No-light

84cm	112cm	140cm
3036A	3036B	3036C



Geometrical element No-light

17x17cm	28x17cm	28x28cm
3036KGA	3036KGT	3036KGC

OF	DM
BV	NE
E2	E19
24°	
● B 3000K	
○ C 4000K	

OF	DM
BV	NE
24°	
● B 3000K	

OF	DM
BV	NE

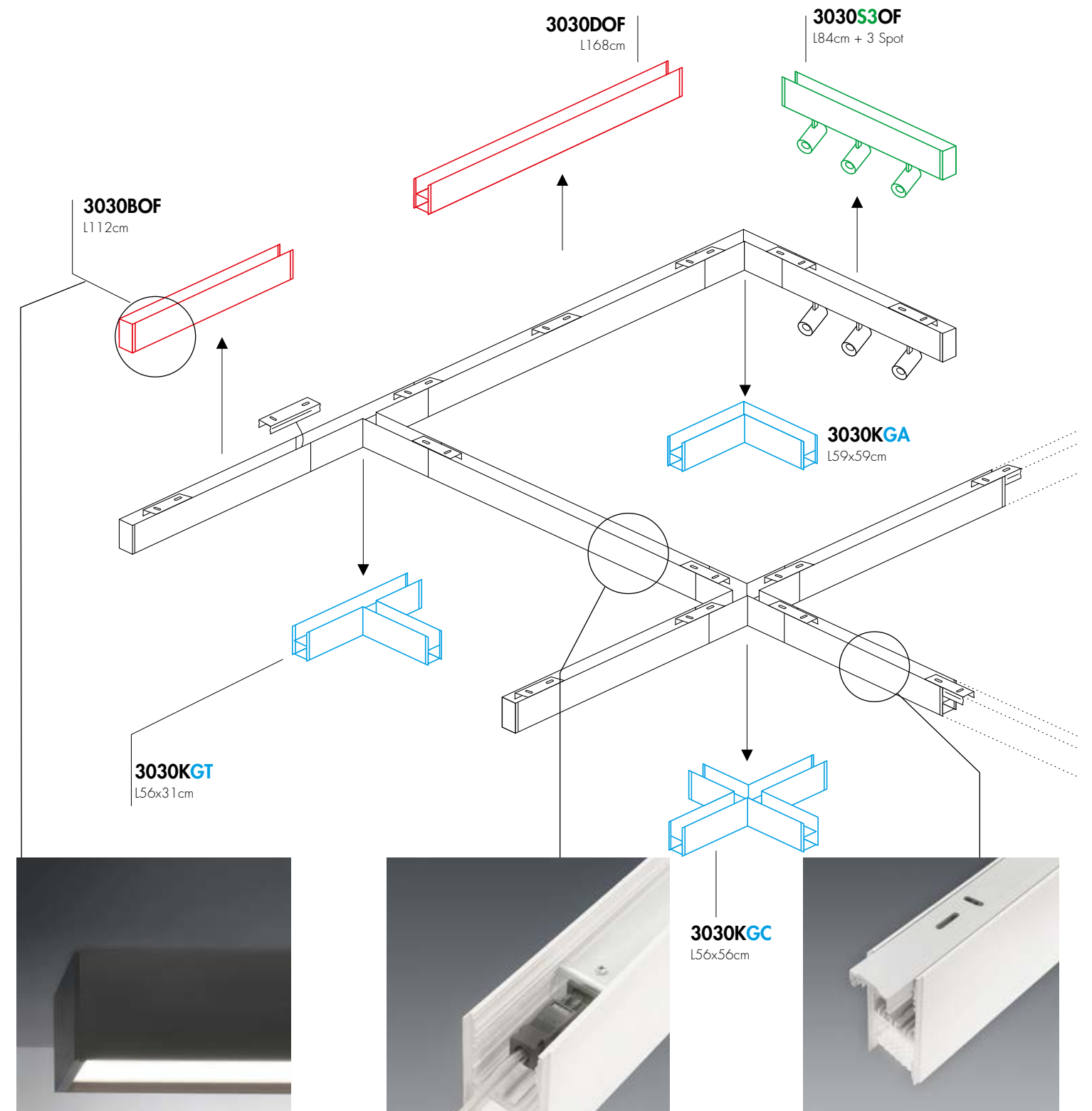



configurazione standard: / basic configuration: / Standard Konfiguration:

E2 Opale - Opal

● B 3000K

BV

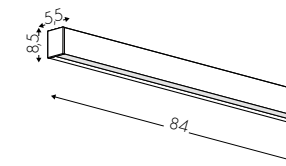

112

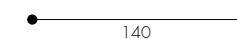

140

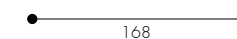

168

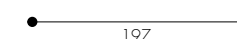

197

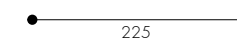

225

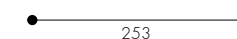

253

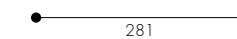

281

3030AOFBVE2B	26W 2260lm* - 220V	347,00 €
3030ADMBVE2B	DALI (Push) - 26W 2260lm - 220V	394,00 €
3030ATFBVE2B	26W 2260lm - 220V	394,00 €
3030BOFBVE2B	35W 3010lm - 220V	355,00 €
3030BDMBVE2B	DALI (Push) - 35W 3010lm - 220V	410,00 €
3030BTFBVE2B	35W 3010lm - 220V	410,00 €
3030COFBVE2B	44W 3765lm - 220V	383,00 €
3030CDMBVE2B	DALI (Push) - 44W 3765lm - 220V	440,00 €
3030CTFBVE2B	44W 3765lm - 220V	440,00 €
3030DOFBVE2B	53W 4515lm - 220V	430,00 €
3030DDMBVE2B	DALI (Push) - 53W 4515lm - 220V	488,00 €
3030DTFBVE2B	53W 4515lm - 220V	488,00 €
3030EOFBVE2B	62W 5265lm - 220V	482,00 €
3030EDMBVE2B	DALI (Push) - 62W 5265lm - 220V	542,00 €
3030ETFBVE2B	62W 5265lm - 220V	542,00 €
3030FOFBVE2B	70W 6020lm - 220V	535,00 €
3030FDMBVE2B	DALI (Push) - 70W 6020lm - 220V	597,00 €
3030FTFBVE2B	70W 6020lm - 220V	597,00 €
3030GOFBVE2B	79W 6775lm - 220V	589,00 €
3030GDMBVE2B	DALI (Push) - 79W 6775lm - 220V	636,00 €
3030GTFBVE2B	79W 6775lm - 220V	636,00 €
3030HOFBVE2B	88W 7525lm - 220V	645,00 €
3030HDMBVE2B	DALI (Push) - 88W 7525lm - 220V	695,00 €
3030HTFBVE2B	88W 7525lm - 220V	695,00 €

Configura 

Configure / Konfigurieren

www.teamitaliailluminazione.it



E19 UGR<19 Prism

C 4000K

NE



CODICE COMPLETO DEL PRODOTTO NELLA FOTO
FULL PRODUCT CODE AS SHOWN IN PICTURE - VOLLSTÄNDIGER CODE VOM ARTIKEL IM BILD

3030GOF **NE** **E19** **B**

Codice
Code

Finitura
Finishing
Lackierung

Diffusore
Diffuser
Diffusor

Tonalità
Hue
Farbton

TF Taglio di Fase - Phase-Cut Dimmer - Erhältlich Phasenabschnittdimmer

A Alimentatore Incorporato - Incorporated Power Supply - Eingebautes Netzteil

* 2260lm effettivi - effective - effektive con - with - mit **E2**
2655lm effettivi - effective - effektive con - with - mit **E19** ↻ +17,5%

configurazione standard: / basic configuration: / Standard Konfiguration:

E2 Opale - Opal

● B 3000K

BV

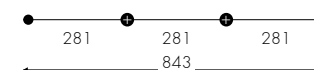
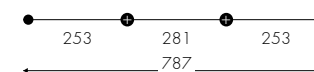
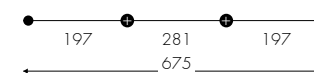
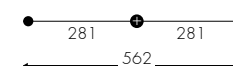
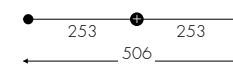
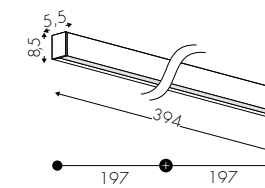

3030LOFBVE2B	123W 10530lm* - 220V	1.059,00 €
3030LDMBVE2B	DALI (Push) - 123W 10530lm - 220V	1.209,00 €
3030LTFBVE2B	123W 10530lm - 220V	1.209,00 €
3030MOFBVE2B	158W 13550lm - 220V	1.224,00 €
3030MDMBVE2B	DALI (Push) - 158W 13550lm - 220V	1.342,00 €
3030MTFBVE2B	158W 13550lm - 220V	1.342,00 €
3030NOFBVE2B	176W 15050lm - 220V	1.343,00 €
3030NDMBVE2B	DALI (Push) - 176W 15050lm - 220V	1.575,00 €
3030NTFBVE2B	176W 15050lm - 220V	1.575,00 €
3030OOFBVE2B	212W 18060lm - 220V	1.753,00 €
3030ODMBVE2B	DALI (Push) - 212W 18060lm - 220V	1.975,00 €
3030OTFBVE2B	212W 18060lm - 220V	1.975,00 €
3030POFBVE2B	246W 21070lm - 220V	2.035,00 €
3030PDMBVE2B	DALI (Push) - 246W 21070lm - 220V	2.238,00 €
3030PTFBVE2B	246W 21070lm - 220V	2.238,00 €
3030QOFBVE2B	264W 22575lm - 220V	2.178,00 €
3030QDMBVE2B	DALI (Push) - 264W 22575lm - 220V	2.513,00 €
3030QTFBVE2B	264W 22575lm - 220V	2.513,00 €
3030ROFBVE2B	317W 27090lm - 220V	2.607,00 €
3030RDMBVE2B	DALI (Push) - 317W 27090lm - 220V	2.943,00 €
3030RTFBVE2B	317W 27090lm - 220V	2.943,00 €

Configura 

Configure / Konfigurieren

www.teamitaliailluminazione.it



E19 UGR<19 Prism

C 4000K

NE



 **CODICE COMPLETO DEL PRODOTTO NELLA FOTO**
FULL PRODUCT CODE AS SHOWN IN PICTURE - VOLLSTÄNDIGER CODE VOM ARTIKEL IM BILD

3030LOF **NE** **E2** **B**

Codice
Code

Finitura
Finishing
Lackierung

Diffusore
Diffuser
Diffusor

Tonalità
Hue
Farbton

TF Taglio di Fase - Phase-Cut Dimmer - Erhältlich Phasenabschnittdimmer

A Alimentatore Incorporato - Incorporated Power Supply - Eingebautes Netzteil

* 10530lm effettivi - effective - effektive con - with - mit **E2**
12390lm effettivi - effective - effektive con - with - mit **E19**  **+17,5%**

configurazione standard: / basic configuration: / Standard Konfiguration:

BV

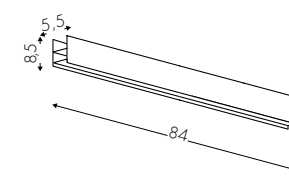

3036AOFBV*
3036ADMBV

Modulo non luminoso - No light element - Deckenleuchte Blindabdeckung
Modulo non luminoso - No light element - Deckenleuchte Blindabdeckung

185,00 €
197,00 €

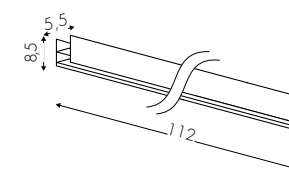

3036BOFBV*
3036BDMBV

Modulo non luminoso - No light element - Deckenleuchte Blindabdeckung
Modulo non luminoso - No light element - Deckenleuchte Blindabdeckung

199,00 €
218,00 €

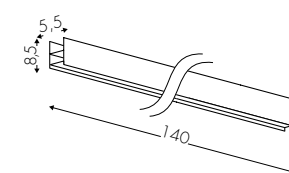

3036COFBV*
3036CDMBV

Modulo non luminoso - No light element - Deckenleuchte Blindabdeckung
Modulo non luminoso - No light element - Deckenleuchte Blindabdeckung

215,00 €
232,00 €

Configura 

Configure / Konfigurieren

www.teamitaliailluminazione.it



NE



 **CODICE COMPLETO DEL PRODOTTO NELLA FOTO**
FULL PRODUCT CODE AS SHOWN IN PICTURE - VOLLSTÄNDIGER CODE VOM ARTIKEL IM BILD

3036COF **NE**

Codice
Code

Finitura
Finishing
Lackierung

configurazione standard: / basic configuration: / Standard Konfiguration:

24° Ottica - Optic - Optik ● B 3000K

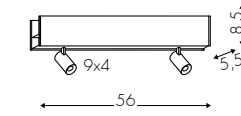

3030S2OFBV24B
3030S2DMBV24B

Spot 2x7W 2x680lm* - 220V
DALI (Push) - Spot 2x7W 2x680lm - 220V

399,00 €
506,00 €

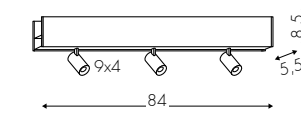

3030S3OFBV24B
3030S3DMBV24B

Spot 3x7W 3x680lm - 220V
DALI (Push) - Spot 3x7W 3x680lm - 220V

515,00 €
633,00 €

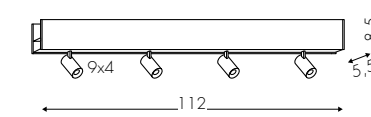

3030S4OFBV24B
3030S4DMBV24B

Spot 4x7W 4x680lm - 220V
DALI (Push) - Spot 4x7W 4x680lm - 220V

608,00 €
726,00 €

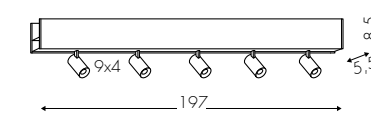

3030S5OFBV24B
3030S5DMBV24B

Spot 5x7W 5x680lm - 220V
DALI (Push) - Spot 5x7W 5x680lm - 220V

900,00 €
1.000,00 €

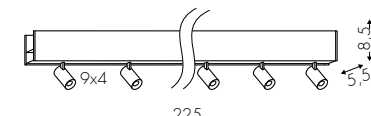

3030S6OFBV24B
3030S6DMBV24B

Spot 5x7W 5x680lm - 220V
DALI (Push) - Spot 5x7W 5x680lm - 220V

1.273,00 €
1.431,00 €

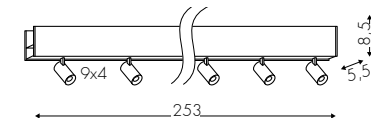

3030S7OFBV24B
3030S7DMBV24B

Spot 5x7W 5x680lm - 220V
DALI (Push) - Spot 5x7W 5x680lm - 220V

1.389,00 €
1.550,00 €

Configura

Configure / Konfigurieren

www.teamitaliailluminazione.it



○ C 4000K



A Alimentatore Incorporato - Incorporated Power Supply - Eingebautes Netzteil

* 2x680lm effettivi - effective - effektive con - with - mit 24°



CODICE COMPLETO DEL PRODOTTO NELLA FOTO
FULL PRODUCT CODE AS SHOWN IN PICTURE - VOLLSTÄNDIGER CODE VOM ARTIKEL IM BILD

3030S2OF **NE** **24** **B**

Codice Code	Finitura Finishing Lackierung	Diffusore Diffuser Diffusor	Tonalità Hue Farbton
----------------	-------------------------------------	-----------------------------------	----------------------------



configurazione standard: / basic configuration: / Standard Konfiguration:

E2 Opale - Opal

● B 3000K

BV

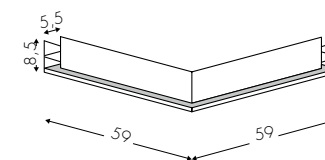

3030KGAOFBVE2B

35W 3010lm* - 220V

454,00 €

3030KADMBVE2B

DALI (Push) - 35W 3010lm - 220V

520,00 €

3030KATFBVE2B

35W 3010lm - 220V

520,00 €

Configura

Configure / Konfigurieren

www.teamitaliailluminazione.it

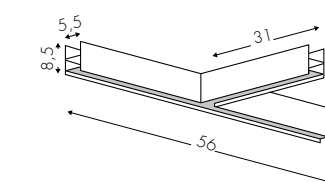

3030KGTDFBVE2B

26W 2250lm - 220V

563,00 €

3030KGTDMBVE2B

DALI (Push) - 26W 2250lm - 220V

634,00 €

3030KGTTFBVE2B

26W 2250lm - 220V

634,00 €

Configura

Configure / Konfigurieren

www.teamitaliailluminazione.it

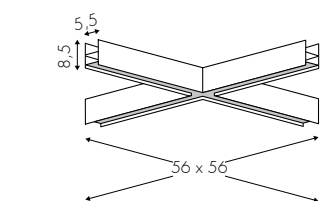

3030KGCDFBVE2B

35W 3010lm - 220V

741,00 €

3030KCDMBVE2B

DALI (Push) - 35W 3010lm - 220V

817,00 €

3030KGCTFBVE2B

35W 3010lm - 220V

817,00 €

Configura

Configure / Konfigurieren

www.teamitaliailluminazione.it



E19 UGR<19 Prism

○ C 4000K

NE



CODICE COMPLETO DEL PRODOTTO NELLA FOTO
FULL PRODUCT CODE AS SHOWN IN PICTURE - VOLLSTÄNDIGER CODE VOM ARTIKEL IM BILD

3030KGAOF **NE** **E2** **B**

Codice
Code

Finitura
Finishing
Lackierung

Diffusore
Diffuser
Diffusor

Tonalità
Hue
Farbton

TF Taglio di Fase - Phase-Cut Dimmer - Erhältlich Phasenabschrittdimmer

A Alimentatore Incorporato - Incorporated Power Supply - Eingebautes Netzteil

* 3010lm effettivi - effective - effektive con - with - mit **E2**
3540lm effettivi - effective - effektive con - with - mit **E19** ↻ +17,5%



configurazione standard: / basic configuration: / Standard Konfiguration:

BV

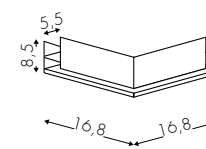

3036KGAOFBV*
3036KGADMBV

Modulo non luminoso - No light element - No licht element
Modulo non luminoso - No light element - No licht element

260,00 €
285,00 €

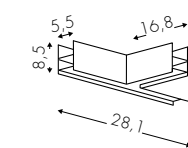

3036KGT OFBV*
3036KGTDMBV

Modulo non luminoso - No light element - No licht element
Modulo non luminoso - No light element - No licht element

282,00 €
306,00 €

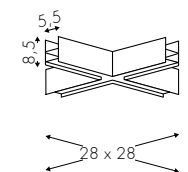

3036KGC OFBV*
3036KGCDBV

Modulo non luminoso - No light element - No licht element
Modulo non luminoso - No light element - No licht element

303,00 €
328,00 €

Configura 

Configure / Konfigurieren

www.teamitaliailluminazione.it



NE



 **CODICE COMPLETO DEL PRODOTTO NELLA FOTO**
FULL PRODUCT CODE AS SHOWN IN PICTURE - VOLLSTÄNDIGER CODE VOM ARTIKEL IM BILD

3036KGT OF **NE**

Codice
Code

Finitura
Finishing
Lackierung



configurazione standard: / basic configuration: / Standard Konfiguration:

24° Ottica - Optic - Optik ● B 3000K

BV

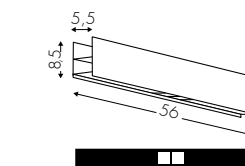

3046ZOFBV24B
3046ZDMBV24B

9W 900lm* - 220V
DALI (Push) - 9W 900lm - 220V

415,00 €
521,00 €

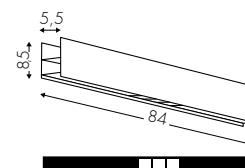

3046AOFBV24B
3046ADMBV24B

13W 1500lm - 220V
DALI (Push) - 13W 1500lm - 220V

528,00 €
644,00 €

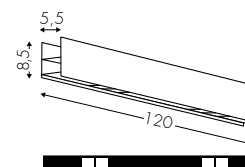

3046BOFBV24B
3046BDMBV24B

2x9W 2x900lm - 220V
DALI (Push) - 2x9W 2x900lm - 220V

631,00 €
749,00 €

Configura  Configure / Konfigurieren

www.teamitaliailluminazione.it 



NE

A Alimentatore Incorporato - Incorporated Power Supply - Eingebautes Netzteil

* 900lm effettivi - effective - effektive con - with - mit 24°

 **CODICE COMPLETO DEL PRODOTTO NELLA FOTO**
FULL PRODUCT CODE AS SHOWN IN PICTURE - VOLLSTÄNDIGER CODE VOM ARTIKEL IM BILD

3046BOF **NE** **24** **B**

Codice
Code

Finitura
Finishing
Lackierung

Diffusore
Diffuser
Diffusor

Tonalità
Hue
Farbton

MIRÓ APPLIQUE

UPLIGHT - DOWNLIGHT

PARETE
WALL LIGHT
WANDLEUCHTE



configurazione standard: / basic configuration: / Standard Konfiguration:

E2 Opale - Opal

B 3000K

BV

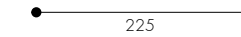
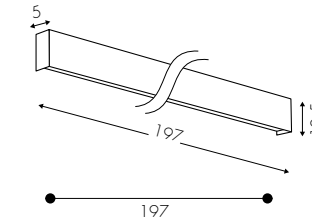

2030EOFBVE2B
2030EDMBVE2B

44W 4570lm* + 44W 4570lm - 220V
DALI(Push) 44W 4570lm + 44W 4570lm - 220V

680,00 €
780,00 €

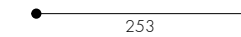

2030FOFBVE2B
2030FDMBVE2B

50W 5200lm + 50W 5200lm - 220V
DALI(Push) 50W 5200lm + 50W 5200lm - 220V

752,00 €
854,00 €

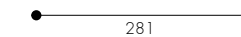

2030GOFBVE2B
2030GDMBVE2B

56W 5820lm + 56W 5820lm - 220V
DALI(Push) 56W 5820lm + 56W 5820lm - 220V

788,00 €
891,00 €

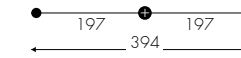

2030HOFBVE2B
2030HDMBVE2B

63W 6500lm + 63W 6500lm - 220V
DALI(Push) 63W 6500lm + 63W 6500lm - 220V

814,00 €
918,00 €

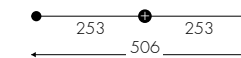

2030LOFBVE2B
2030LDMBVE2B

88W 9140lm + 88W 9140lm - 220V
DALI(Push) 88W 9140lm + 88W 9140lm - 220V

1.432,00 €
1.634,00 €

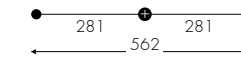

2030MOFBVE2B
2030MDMBVE2B

112W 11640lm + 112W 11640lm - 220V
DALI(Push) 112W 11640lm + 112W 11640lm - 220V

1.566,00 €
1.772,00 €

2030NOFBVE2B
2030NDMBVE2B

126W 13000lm + 126W 13000lm - 220V
DALI(Push) 126W 13000lm + 126W 13000lm - 220V

1.741,00 €
1.952,00 €

Configura

Configure / Konfigurieren

www.teamitaliailluminazione.it



A 2700K C 4000K

NE

A Alimentatore Incorporato - Incorporated Power Supply - Eingebautes Netzteil

* 4570lm effettivi - effective - effektive con - with - mit E2

CODICE COMPLETO DEL PRODOTTO NELLA FOTO
FULL PRODUCT CODE AS SHOWN IN PICTURE - VOLLSTÄNDIGER CODE VOM ARTIKEL IM BILD

2030FOF **NE** **E2** **B**

Codice
Code

Finitura
Finishing
Lackierung

Diffusore
Diffuser
Diffusor

Tonalità
Hue
Farbton

MIRÓ APPLIQUE

UPLIGHT - DOWNLIGHT

PARETE
WALL LIGHT
WANDLEUCHE



configurazione standard: / basic configuration: / Standard Konfiguration:

E2 Opale - Opal

B 3000K

BV

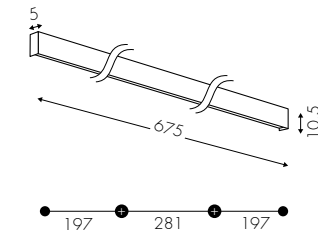

2030OOFBVE2B
2030ODMBVE2B

151W 15640lm* + 151W 15640lm - 220V
DALI(Push) 151W 15640lm + 151W 15640lm - 220V

2.210,00 €
2.527,00 €

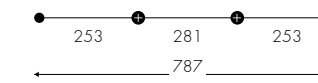

2030POFBVE2B
2030PDMBVE2B

175W 18140lm + 175W 18140lm - 220V
DALI(Push) 175W 18140lm + 175W 18140lm - 220V

2.488,00 €
2.813,00 €

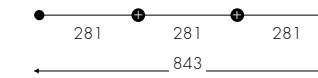

2030QOFBVE2B
2030QDMBVE2B

189W 19500lm + 189W 19500lm - 220V
DALI(Push) 189W 19500lm + 189W 19500lm - 220V

2.671,00 €
3.002,00 €

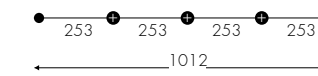

2030ROFBVE2B
2030RDMBVE2B

224W 23280lm + 224W 23280lm - 220V
DALI(Push) 224W 23280lm + 224W 23280lm - 220V

3.461,00 €
3.899,00 €

Configura

Configure / Konfigurieren

www.teamitaliailluminazione.it



A 2700K C 4000K

NE



CODICE COMPLETO DEL PRODOTTO NELLA FOTO
FULL PRODUCT CODE AS SHOWN IN PICTURE - VOLLSTÄNDIGER CODE VOM ARTIKEL IM BILD

2030ROF **NE** **E2** **B**

Codice
Code

Finitura
Finishing
Lackierung

Diffusore
Diffuser
Diffusor

Tonalità
Hue
Farbton

Alimentatore Incorporato
Incorporated Power Supply - Eingebautes Netzteil

* 15640lm effettivi - effective - effektive con - with - mit **E2**

INDEX

SECTION

FAMILY



EMME 24 INCASSO

INCASSO
RECESSED LIGHT
EINBAULEUCHTE



configurazione standard: / basic configuration: / Standard Konfiguration:

E2 Opale

B 3000K

BV

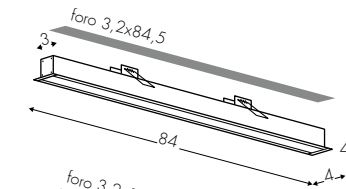

4037ABVE2B

19W 1435lm* - 24VDC

163,00 €

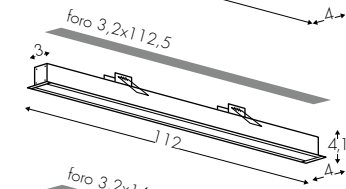

4037BBVE2B

25W 1910lm - 24VDC

233,00 €

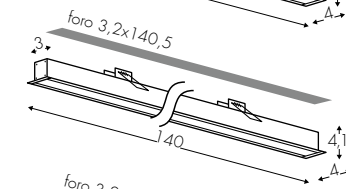

4037CBVE2B

31W 2385lm - 24VDC

271,00 €

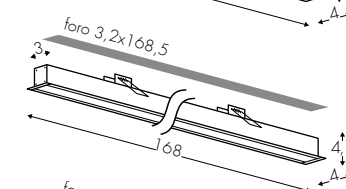

4037DBVE2B

37W 2860lm - 24VDC

324,00 €

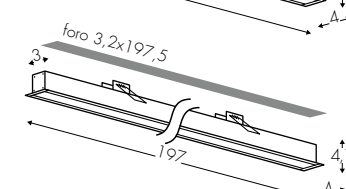

4037EBVE2B

44W 3350lm - 24VDC

352,00 €

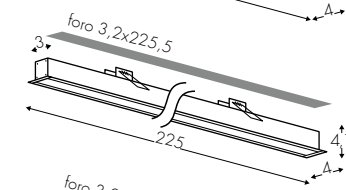

4037FBVE2B

50W 3830lm - 24VDC

373,00 €

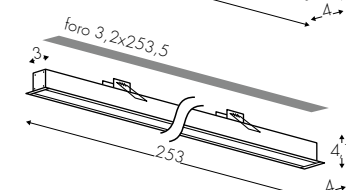

4037GBVE2B

56W 4305lm - 24VDC

395,00 €

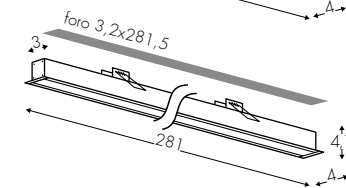

4037HBVE2B

62W 4780lm - 24VDC

417,00 €

Configura



Configure / Konfigurieren

www.teamitaliailluminazione.it



Opal E19 UGR<19 Prism

C 4000K

NE



CODICE COMPLETO DEL PRODOTTO NELLA FOTO
FULL PRODUCT CODE AS SHOWN IN PICTURE - VOLLSTÄNDIGER CODE VOM ARTIKEL IM BILD

4037H

Codice
Code

BV

Finitura
Finishing
Lackierung

E2

Diffusore
Diffuser
Diffusor

B

Tonalità
Hue
Farbton

* Alimentatore non incluso - Power Supply not included - Netzteil nicht inbegriffen

Alimentatori a pag. 564-565 - Drivers p. 564-565 - Netzteil p. 564-565

* 1435lm effettivi - effective - effektive con - with - mit E2

1680lm effettivi - effective - effektive con - with - mit E19 +17,5%

configurazione standard: / basic configuration: / Standard Konfiguration:

E2 Opale

 B 3000K

BV 

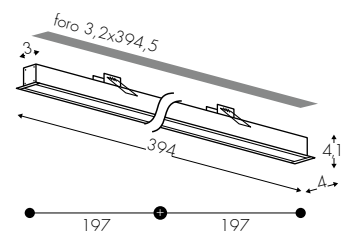

4037LBVE2B

87W 6705lm - 24VDC

775,00 €

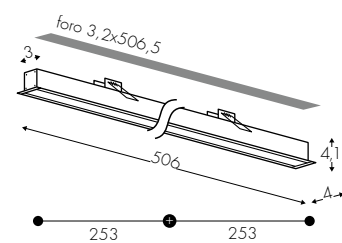

4037MBVE2B

111W 8605lm - 24VDC

969,00 €

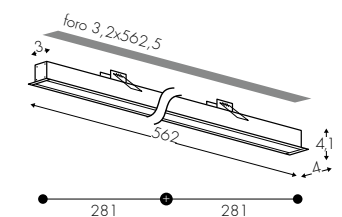

4037NBVE2B

124W 9560lm - 24VDC

1.072,00 €

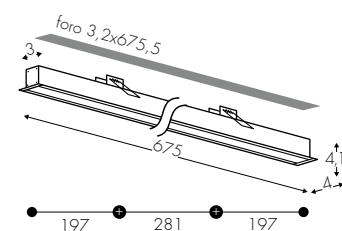

4037OBVE2B

148,5W 11485lm - 24VDC

1.297,00 €

Configura  Configure / Konfigurieren

www.teamitaliailluminazione.it 



Opal E19 UGR<19 Prism  C 4000K

NE 

configurazione standard: / basic configuration: / Standard Konfiguration:

E2 Opale

 B 3000K

BV 

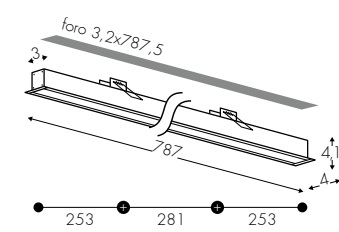

4037PBVE2B

173W 13380lm* - 24VDC

1.526,00 €

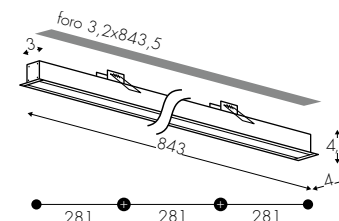

4037QBE2B

185W 14340lm - 24VDC

1.709,00 €

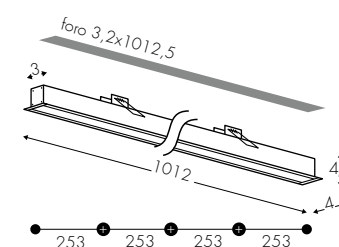

4037RBE2B

223W 17210lm - 24VDC

2.050,00 €

Configura  Configure / Konfigurieren

www.teamitaliailluminazione.it 



Opal E19 UGR<19 Prism  C 4000K

NE 

CODICE COMPLETO • COMPLETE CODE • VOLLSTÄNDIGE CODE

4037L

Codice
Code

BV

Finitura
Finishing
Lackierung

E2

Diffusore
Diffuser
Diffusor

B

Tonalità
Hue
Farbton

 Alimentatore non incluso - Power Supply not included - Netzteil nicht inbegriffen

Alimentatori a pag. 564-565 - Drivers p. 564-565 - Netzteil p. 564-565

* 13380lm effettivi - effective - effektive con - with - mit E2

15740lm effettivi - effective - effektive con - with - mit E19  +17,5%

EMME 24 INCASSO

INCASSO
RECESSED LIGHT
EINBAULEUCHTE



configurazione standard: / basic configuration: / Standard Konfiguration:

E2 Opale

B 3000K

BV

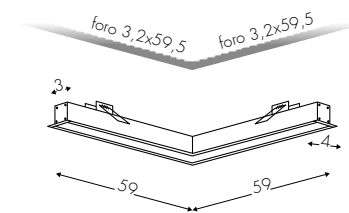

4037KGABVE2B

25W 1905lm* - 24VDC

376,00 €

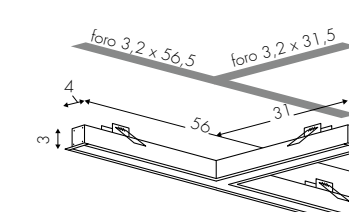

4037KGTBVE2B

19W 1430lm - 24VDC

444,00 €

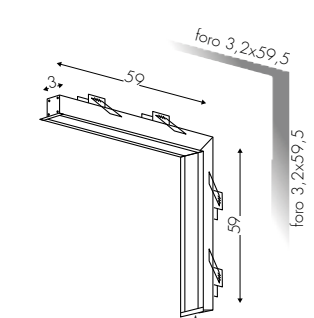

4037KGVBE2B

25W 1905lm - 24VDC

376,00 €

Configura

Configure / Konfigurieren

www.teamitaliailluminazione.it



Opal E19 UGR<19 Prism

C 4000K

NE



CODICE COMPLETO DEL PRODOTTO NELLA FOTO
FULL PRODUCT CODE AS SHOWN IN PICTURE - VOLLSTÄNDIGER CODE VOM ARTIKEL IM BILD

4037KGA **BV** **E2** **B**

Codice
Code

Finitura
Finishing
Lackierung

Diffusore
Diffuser
Diffusor

Tonalità
Hue
Farbton

Alimentatore non incluso - Power Supply not included - Netzteil nicht inbegriffen
Alimentatori a pag. 564-565 - Drivers p. 564-565 - Netzteil p. 564-565

* 1905lm effettivi - effective - effektive con - with - mit E2
2240lm effettivi - effective - effektive con - with - mit E19 +17,5%

MIRÓ INCASSO

INCASSO
RECESSED LIGHT
EINBAULEUCHTE



configurazione standard: / basic configuration: / Standard Konfiguration:

E2 Opale

● B 3000K

BV

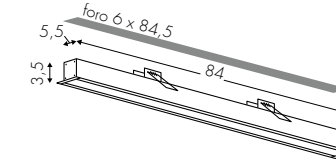

4030AOFBVE2B
4030ADMBVE2B

26W 2260lm* - 220V
DALI(Push) 26W 2260lm - 220V

329,00 €
374,00 €

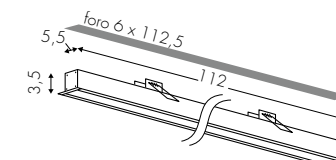

4030BOFBVE2B
4030BDMBVE2B

35W 3010lm - 220V
DALI(Push) 35W 3010lm - 220V

336,00 €
391,00 €

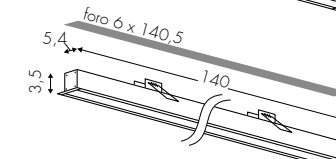

4030COFBVE2B
4030CDMBVE2B

44W 3765lm - 220V
DALI(Push) 44W 3765lm - 220V

379,00 €
435,00 €

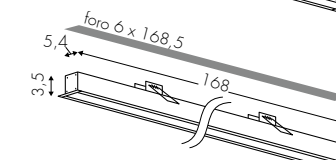

4030DOFBVE2B
4030DDMBVE2B

53W 4515lm - 220V
DALI(Push) 53W 4515lm - 220V

395,00 €
464,00 €

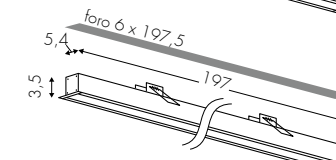

4030EOFBVE2B
4030EDMBVE2B

62W 5265lm - 220V
DALI(Push) 62W 5265lm - 220V

411,00 €
469,00 €

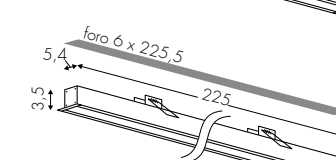

4030FOFBVE2B
4030FDMBVE2B

70W 6020lm - 220V
DALI(Push) 70W 6020lm - 220V

508,00 €
567,00 €

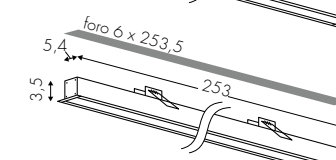

4030GOFBVE2B
4030GDMBVE2B

79W 6775lm - 220V
DALI(Push) 79W 6775lm - 220V

566,00 €
641,00 €

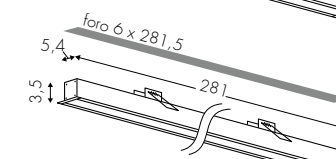

4030HOFBVE2B
4030HDMBVE2B

88W 7525lm - 220V
DALI(Push) 88W 7525lm - 220V

613,00 €
660,00 €

Configura

Configure / Konfigurieren

www.teamitaliailluminazione.it



Opal E19 UGR<19 Prism

C 4000K

NE



CODICE COMPLETO DEL PRODOTTO NELLA FOTO
FULL PRODUCT CODE AS SHOWN IN PICTURE - VOLLSTÄNDIGER CODE VOM ARTIKEL IM BILD

4030DOF **BV** **E2** **B**

Codice
Code

Finitura
Finishing
Lackierung

Diffusore
Diffuser
Diffusor

Tonalità
Hue
Farbton

Alimentatore Incluso in remoto - Remote Power Supply - Fernspeisung enthalten

* 2260lm effettivi - effective - effektive con - with - mit E2
2655lm effettivi - effective - effektive con - with - mit E19 +17,5%



configurazione standard: / basic configuration: / Standard Konfiguration:

E2 Opale

● B 3000K

BV

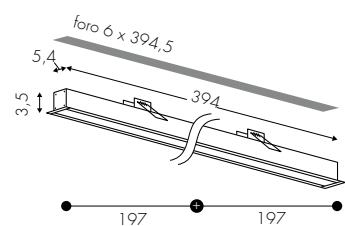

4030LOFBVE2B
4030LDMBVE2B

123W 10530lm - 220V
DALI(Push) 123W 10530lm - 220V

822,00 €
937,00 €

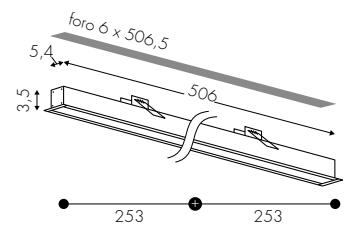

4030MOFBVE2B
4030MDMBVE2B

158W 13550lm - 220V
DALI(Push) 158W 13550lm - 220V

1.132,00 €
1.281,00 €

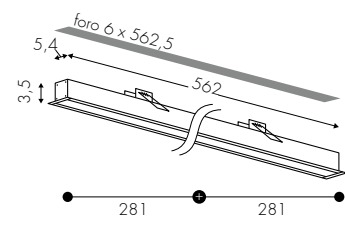

4030NOFBVE2B
4030NDMBVE2B

176W 15050lm - 220V
DALI(Push) 176W 15050lm - 220V

1.225,00 €
1.320,00 €

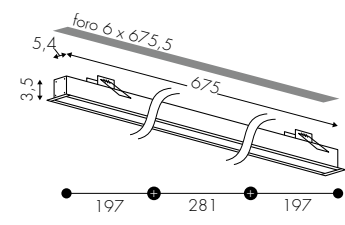

4030OOFBVE2B
4030ODMBVE2B

212W 18060lm - 220V
DALI(Push) 212W 18060lm - 220V

1.435,00 €
1.597,00 €

Configura

Configure / Konfigurieren

www.teamitaliailluminazione.it



Opal E19 UGR<19 Prism ○ C 4000K

NE



A↑ Alimentatore Incluso in remoto - Remote Power Supply - Fernspeisung enthalten

CODICE COMPLETO • COMPLETE CODE • VOLLSTÄNDIGE CODE

4030LOF

BV

E2

B

Codice
Code

Finitura
Finishing
Lackierung

Diffusore
Diffuser
Diffusor

Tonalità
Hue
Farbton

configurazione standard: / basic configuration: / Standard Konfiguration:

E2 Opale

● B 3000K

BV

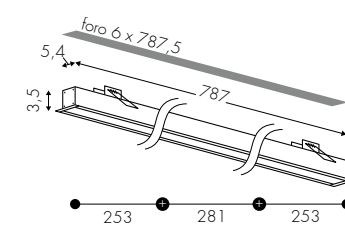

4030POFBVE2B
4030PDMBVE2B

246W 21070lm* - 220V
DALI(Push) 246W 21070lm - 220V

1.744,00 €
1.941,00 €

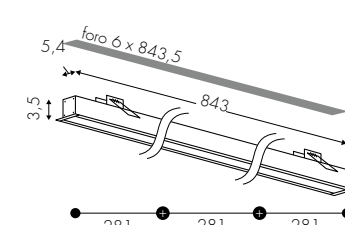

4030QOFBVE2B
4030QDMBVE2B

264W 22575lm - 220V
DALI(Push) 264W 22575lm - 220V

1.838,00 €
1.979,00 €

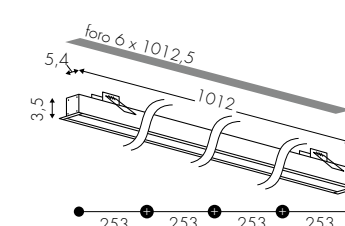

4030ROFBVE2B
4030RDMBVE2B

317W 27090lm - 220V
DALI(Push) 317W 27090lm - 220V

2.195,00 €
2.561,00 €

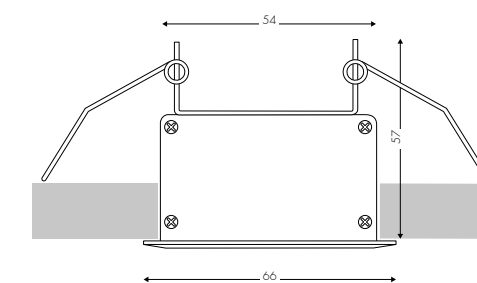

Configura

Configure / Konfigurieren

www.teamitaliailluminazione.it



Opal E19 UGR<19 Prism ○ C 4000K

NE



A↑ Alimentatore Incluso in remoto - Remote Power Supply - Fernspeisung enthalten

* 21070lm effettivi - effective - effektive con - with - mit **E2**
24780lm effettivi - effective - effektive con - with - mit **E19** ↻ **+17,5%**



MIRÓ INCASSO

INCASSO
RECESSED LIGHT
EINBAULEUCHTE



configurazione standard: / basic configuration: / Standard Konfiguration:

E2 Opale

● B 3000K

BV

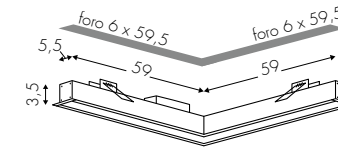

4030KGAOFBVE2B 35W 3010lm* - 220V **430,00 €**
4030KADMBVE2B DALI(Push) 35W 3010lm - 220V **495,00 €**

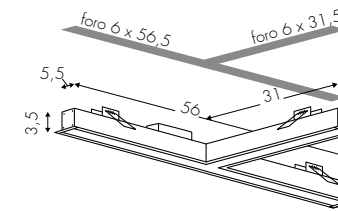

4030KGTDFBVE2B 26W 2250lm - 220V **535,00 €**
4030KGTDMBVE2B DALI(Push) 26W 2250lm - 220V **602,00 €**

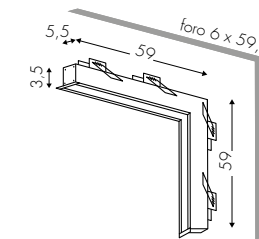

4030KGVDFBVE2B 35W 3010lm - 220V **430,00 €**
4030KGVDMBVE2B DALI(Push) 35W 3010lm - 220V **495,00 €**

Configura

Configure / Konfigurieren

www.teamitaliailluminazione.it



Opal **E19** UGR<19 Prism C 4000K

NE

CODICE COMPLETO DEL PRODOTTO NELLA FOTO
FULL PRODUCT CODE AS SHOWN IN PICTURE - VOLLSTÄNDIGER CODE VOM ARTIKEL IM BILD

4030KGAOF **BV** **E2** **B**

Codice
Code

Finitura
Finishing
Lackierung

Diffusore
Diffuser
Diffusor

Tonalità
Hue
Farbton

Alimentatore Incluso in remoto - Remote Power Supply - Fernspeisung enthalten

* 3010lm effettivi - effective - effektive con - with - mit **E2**
 3540lm effettivi - effective - effektive con - with - mit **E19** ↻ +17,5%



configurazione standard: / basic configuration: / Standard Konfiguration:

E2 Opale - Opal ● B 3000K

BV

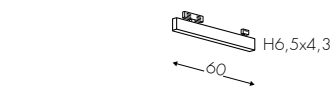

T058UOFBVE2B

9W 1010lm* - 220V

313,00 €

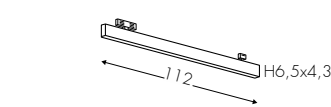

T058BOFBVE2B

18W 2025lm - 220V

423,00 €

T058BDMBVE2B

DALI (Push) - 18W 2025lm - 220V

483,00 €

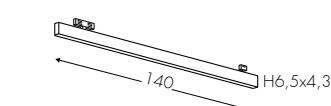

T058COFBVE2B

22W 2530lm - 220V

469,00 €

T058CDMBVE2B

DALI (Push) - 22W 2530lm - 220V

531,00 €

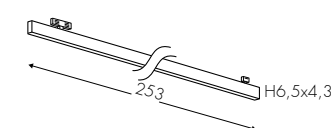

T058GOFBVE2B

39W 4510lm - 220V

641,00 €

T058GDMBVE2B

DALI (Push) - 39W 4510lm - 220V

714,00 €

Configura 

Configure / Konfigurieren

www.teamitaliailluminazione.it 

E19 UGR<19 Prism

● A 2700K ○ C 4000K

NE RU 

A Alimentatore Incorporato - Incorporated Power Supply - Eingebautes Netzteil

* 1010lm effettivi - effective - effektive con - with - mit **E2**
1190lm effettivi - effective - effektive con - with - mit **E19** ↻ +17,5%

 **CODICE COMPLETO DEL PRODOTTO NELLA FOTO**
FULL PRODUCT CODE AS SHOWN IN PICTURE - VOLLSTÄNDIGER CODE VOM ARTIKEL IM BILD

T058UOF **BV** **E2** **B**

Codice
Code

Finitura
Finishing
Lackierung

Diffusore
Diffuser
Diffusor

Tonalità
Hue
Farbton



configurazione standard: / basic configuration: / Standard Konfiguration:

E2 Opale - Opal ● B 3000K

BV

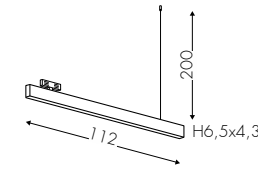

T058BSOFBVE2B 18W 2025lm* - 220V 423,00 €
T058BSDMBVE2B DALI (Push) - 18W 2025lm - 220V 483,00 €

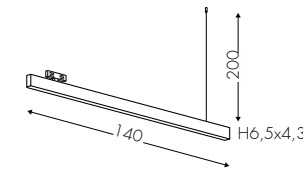

T058CSOFBVE2B 22W 2530lm - 220V 469,00 €
T058CSDMBVE2B DALI (Push) - 22W 2530lm - 220V 531,00 €

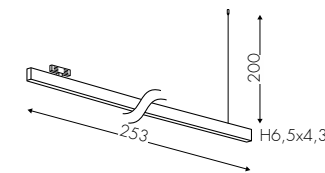

T058HSOFBVE2B 39W 4510lm - 220V 641,00 €
T058HSDMBVE2B DALI (Push) - 39W 4510lm - 220V 714,00 €

Configura  Configure / Konfigurieren

www.teamitaliailluminazione.it 



E19 UGR<19 Prism ● A 2700K ○ C 4000K

NE RU 

A Alimentatore Incorporato - Incorporated Power Supply - Eingebautes Netzteil

* 2025lm effettivi - effective - effektive con - with - mit E2 ↻ +17,5%
 2380lm effettivi - effective - effektive con - with - mit E19

 CODICE COMPLETO DEL PRODOTTO NELLA FOTO
 FULL PRODUCT CODE AS SHOWN IN PICTURE - VOLLSTÄNDIGER CODE VOM ARTIKEL IM BILD

T058BSOF **BV** **E2** **B**

Codice Code Finitura Finishing Diffusore Diffuser Tonalità Hue
 Code Lackierung Diffusor Farbton

Sistema binario 48V
Track system 48V
Gleis 48V

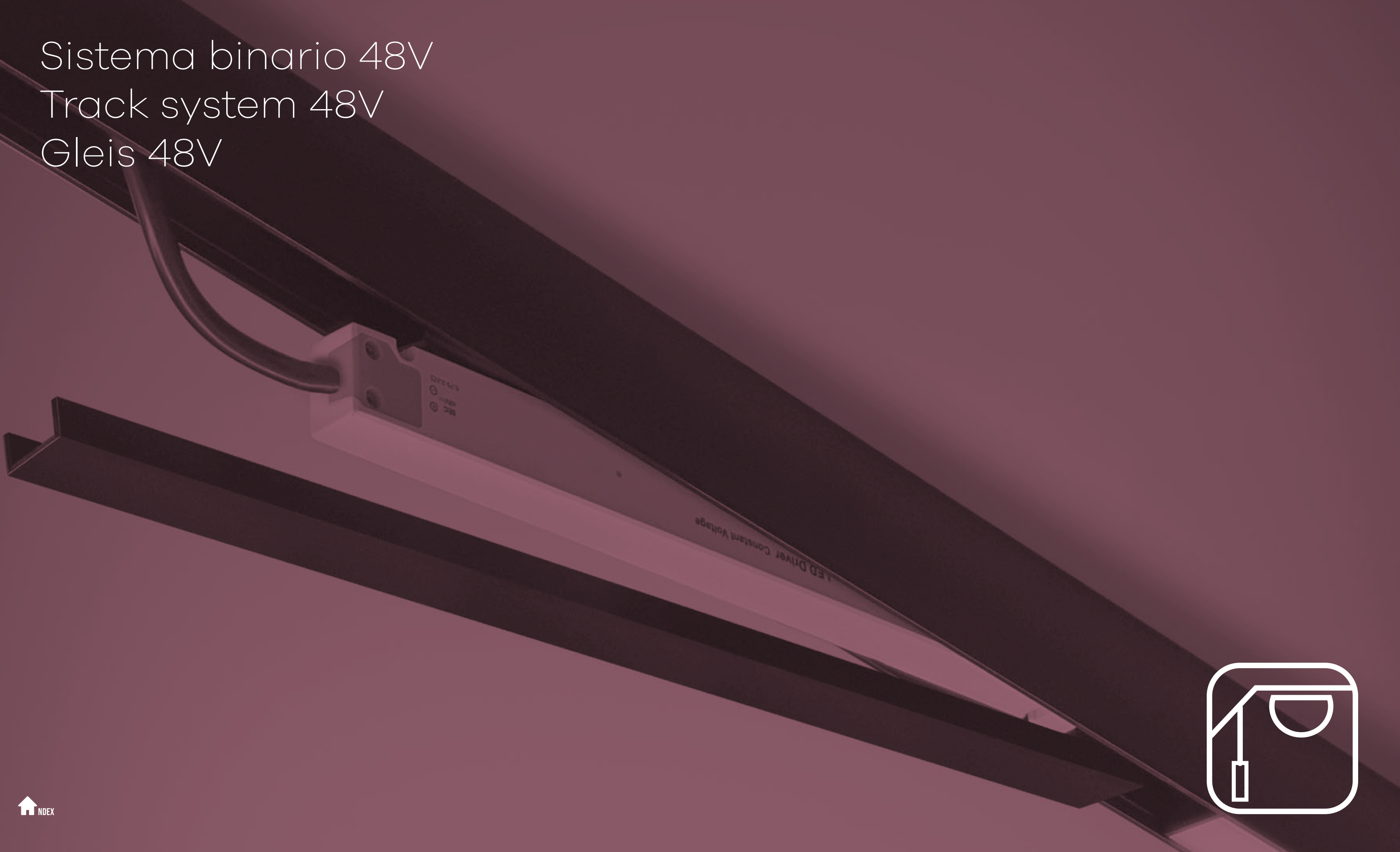



B48 PLAFONE



504



B48 SOSPENSIONE



505



B48 SOSPENSIONE UPLIGHT

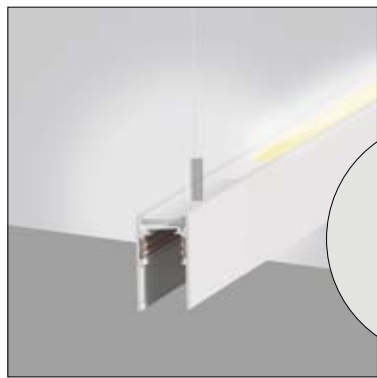

505

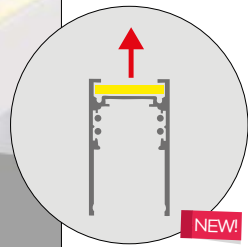

B48 INCASSO



506

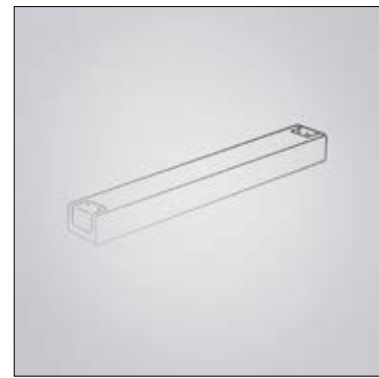

B48 KIT DRIVER

508



B48 CURVE

Sospensione downlight L130/165/270

511



B48 EDGE

Sospensione downlight 31x115/143x59

513



B48 EDGE

Sospensione Uplight 87x87

513



B48 LAMBDA

Sospensione Ø20/Ø30

515



B48 LAMBDA

Binario Ø20/Ø30

515



B48 LICIS

Sospensione Ø20

517



B48 LICIS

Binario Ø20

517



B48 LIEVE

Sospensione L125

519

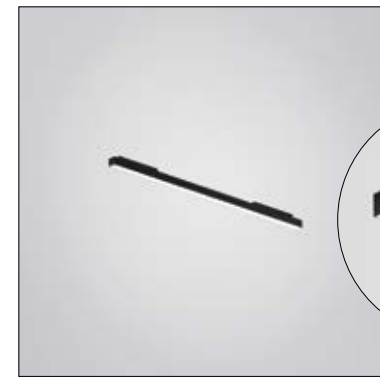

B48 LIEVE

Binario L60

519



B48 LINEA DARK 521
Sospensione L150

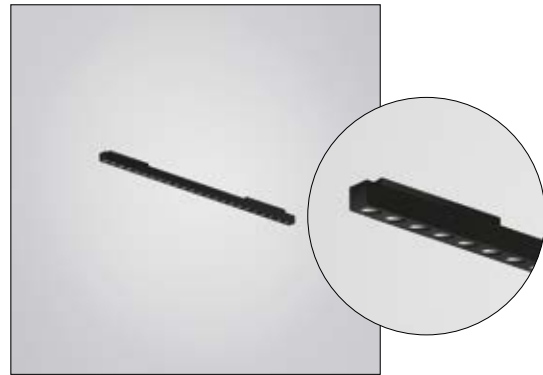

B48 LINEA DARK 521
Binario L22 / 44cm



B48 MICRO 525
L30/50



B48 OKI 529
8x8



B48 OVERLAP DECO' 531
Sospensione up+downlight 75x133



B48 OVERLAP DECO' 531
Sospensione up+downlight 94,5x94,5/87x184



B48 OVERLAP 533
Sospensione L120



B48 OVERLAP 533
Binario L60



B48 SHADOW 535
Sospensione Orizzontale Ø70/Ø95



B48 SHADOW 535
Sospensione Verticale Ø58/Ø70



B48 SPOTLIGHT 537
Binario 4/7/12/18W



B48 MELLOW 523
Sospensione Ø15 x H16



B48 MELLOW 523
Binario Ø15 x H16



B48 TUBICO 539
Sospensione L30/60/90



B48 OGIS 527
Sospensione Ø13,5 x H15



B48 OGIS 527
Binario Ø13,5 x H15



B48 VENIS 541
Sospensione Ø20



B48 VENIS 541
Binario Ø20

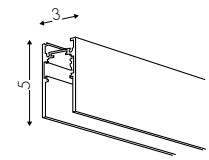

9074A48

Track plafone sospensione 48V DC 2mt
Ceiling suspension Track 48V DC 2mt

BV NE
143,00 €

*SERVIZIO SU MISURA (S.M.)



001001A

Taglio - Cut service

10,00 €

Configura

Configure / Konfigurieren

www.teamitaliailluminazione.it

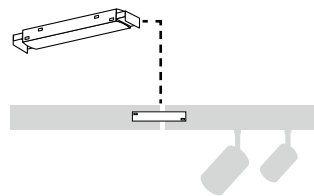

9074P48

Giunto elettrico lineare - Linear electrical joint
Elektrischen Steckverbinder

49,00 €

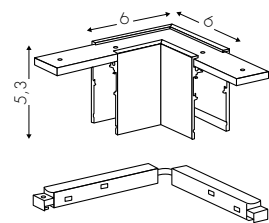

9074C48

Angolare - Corner - Ecke

128,00 €

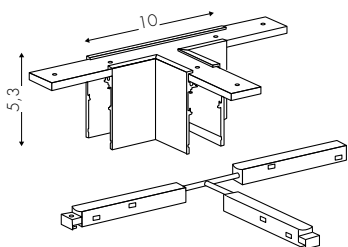

9074D48

Giunto a T - T Connection

187,00 €

Configura

Configure / Konfigurieren

www.teamitaliailluminazione.it

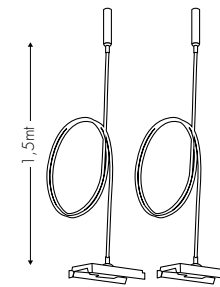

9074F48

Coppia accessori sospensione - Couple of accessories suspension
Paar Zubehör Aufhängung

NE
40,00 €

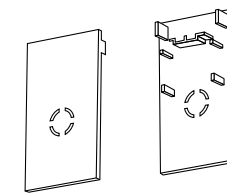

9074B48

Coppia di testate - Couple Endcaps - Paar Endkappen

BV NE
10,00 €

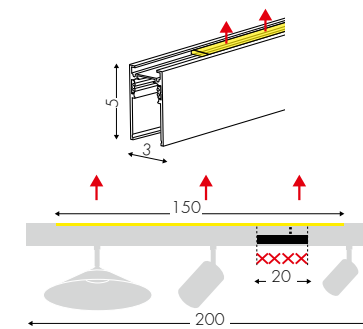

9074U48

Uplight track sospensione 48V DC (2mt) - 33W 4000lm
Uplight suspension track 48V DC (2mt) - 33W 4000lm

248,00 €

Configure / Konfigurieren

Configura

www.teamitaliailluminazione.it



CODICE COMPLETO • COMPLETE CODE • VOLLSTÄNDIGE CODE

9074A48 **NE**

Codice
Code

Finitura
Finishing
Lackierung

CODICE COMPLETO • COMPLETE CODE • VOLLSTÄNDIGE CODE

9074U48 **NE**

Codice
Code

Finitura
Finishing
Lackierung

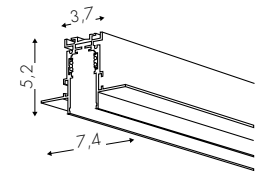

9074I48

Track incasso 48V DC 2mt
Recessed Track 48v DC 2mt



185,00 €

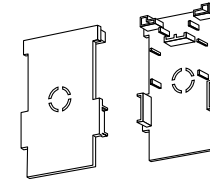

9074L48

Coppia di testate - Couple Endcaps - Paar Endkappen



10,00 €

*SERVIZIO SU MISURA (S.M.)



001001A

Taglio - Cut service

10,00 €

Configura

Configure / Konfigurieren

www.teamitaliailluminazione.it

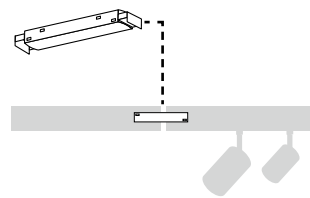

9074P48

Giunto elettrico lineare
Linear electrical joint - Elektrischen Steckverbinder

49,00 €

Configura

Configure / Konfigurieren

www.teamitaliailluminazione.it

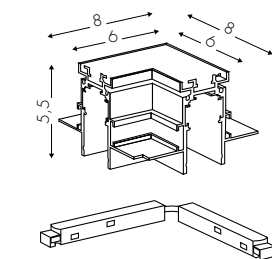

9074M48

Angolare - Corner - Ecke

144,00 €

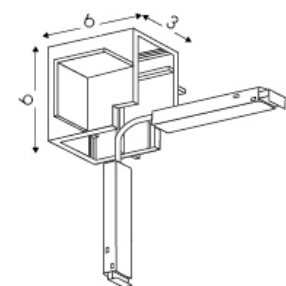

9074O48

Angolare verticale - Vertical Corner - Vertikal Ecke

144,00 €

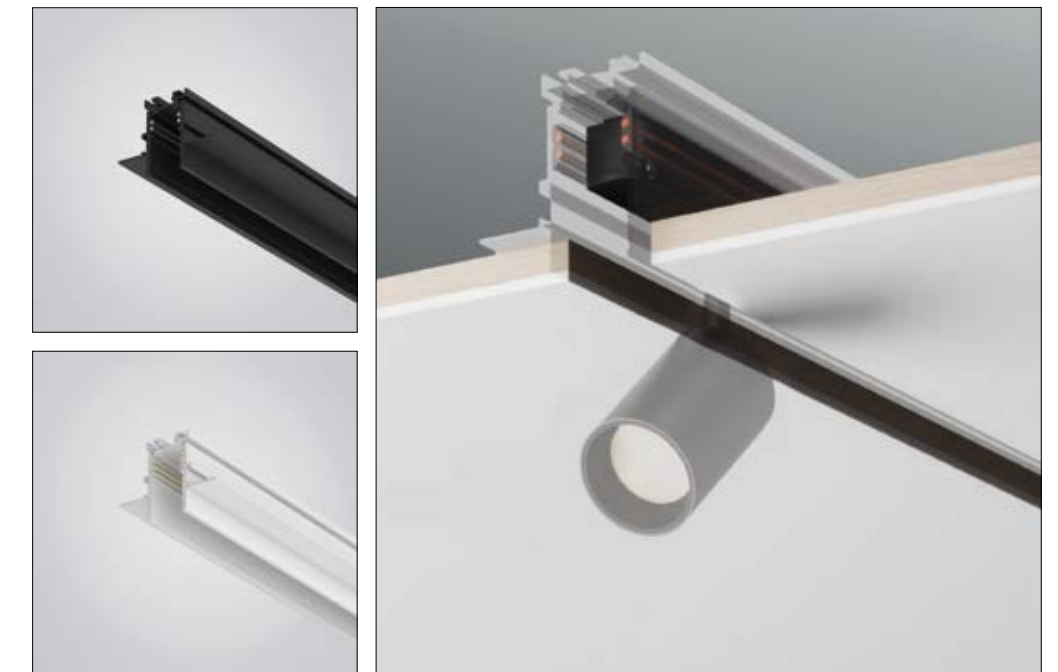

CODICE COMPLETO • COMPLETE CODE • VOLLSTÄNDIGE CODE

9074I48 **NE**

Codice
Code

Finitura
Finishing
Lackierung

CODICE COMPLETO • COMPLETE CODE • VOLLSTÄNDIGE CODE

9074L48 **NE**

Codice
Code

Finitura
Finishing
Lackierung



BV NE



DRIVER INSIDE (nel binario - inside track - in Gleis)

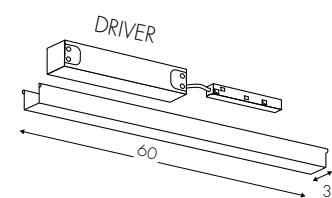

9074H48

Kit driver inside 100W 48VDC
+ cover + connettore connector ON/OFF

150,00 €

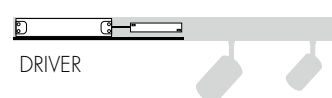

DRIVER OUTSIDE (remoto - remote - entfernt gelegen)

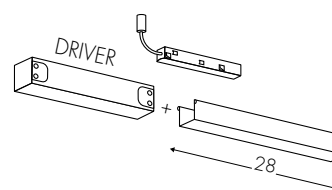

9074HB48TF

Kit driver outside 100W 48V DC Triac

260,00 €

9074GB48

Kit driver outside 150W - 48V DC ON/OFF

188,00 €

9074GB48TF

Kit driver outside 150W 48V DC Triac

330,00 €

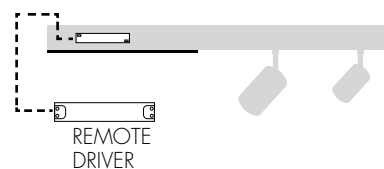

ACCESSORIES

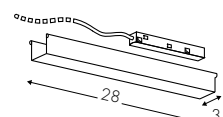

9074Z48

Kit connettore - connection kit + cover - NO DRIVER

65,00 €



NO DRIVER

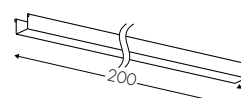

9074Q48

B48 - Cover L200cm

29,00 €

Configura Configure / Konfigurieren

www.teamitaliailluminazione.it

ESEMPIO 1 PLAFONE

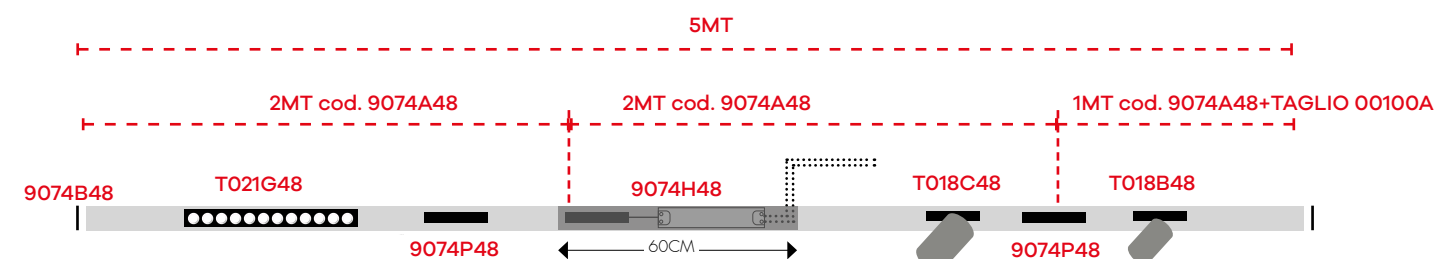

ESEMPIO 2 INCASSO



CODICE COMPLETO • COMPLETE CODE • VOLLSTÄNDIGE CODE

9074H48 **NE**

Codice
Code

Finitura
Finishing
Lackierung



SISTEMA B48

configurazione standard: / basic configuration: / Standard Konfiguration:

E2 Opale - Opal

B 3000K

BV

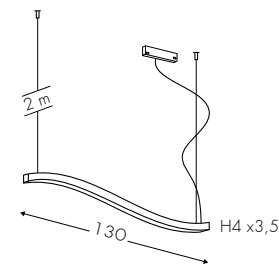

T022N48NEE2B

35W 3570lm* - 48V DC

567,00 €

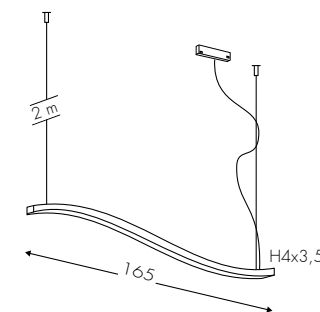

T022M48NEE2B

45W 3350lm - 48V DC

609,00 €

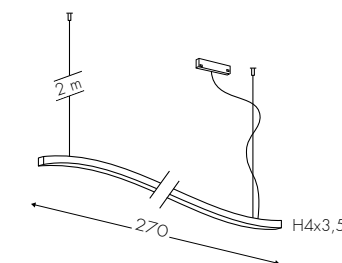

T022H48NEE2B

70W 5880lm - 48V DC

803,00 €



0074A2

Servizio doppia accensione
Dual switch service - Service Doppelzündung

50,00 €

Configura

Configure / Konfigurieren

www.teamitaliailluminazione.it



E19 Prismatico - Prism

NE RU

CODICE COMPLETO DEL PRODOTTO NELLA FOTO
FULL PRODUCT CODE AS SHOWN IN PICTURE - VOLLSTÄNDIGER CODE VOM ARTIKEL IM BILD

T022M48

NE

E2

B

Codice
Code

Finitura
Finishing
Lackierung

Diffusore
Diffuser
Diffusor

Tonalità
Hue
Farbton



Alimentatore non incluso - Power Supply not included - Netzteil nicht enthalten

* 3570lm effettivi - effective - effektive con - with - mit **E2**
4200lm effettivi - effective - effektive con - with - mit **E19** +17,5%

SISTEMA B48

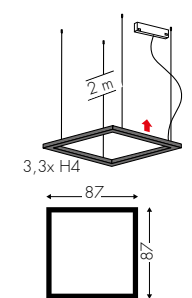
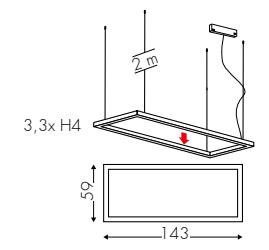
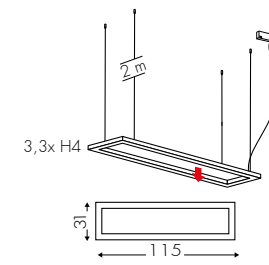

configurazione standard: / basic configuration: / Standard Konfiguration:

E2 Opale - Opal ● B 3000K BV

T028N48BVE2B 62W 4560lm* - 48V DC **613,00 €**

T028M48BVE2B 75W 5470lm - 48V DC **940,00 €**

0074A2 Servizio doppia accensione
Dual switch service - Service Doppelzündung **50,00 €**

[Configura](#)  Configure / Konfigurieren

www.teamitaliailluminazione.it 

E19 Prismatico - Prism NE

configurazione standard: / basic configuration: / Standard Konfiguration:

E28 Satinato
Frosted - Satiniert ● B 3000K BV





T028C48BVE28B 75W 6435lm - 48V DC **819,00 €**

0074A2 Servizio doppia accensione
Dual switch service - Service Doppelzündung **50,00 €**

[Configura](#)  Configure / Konfigurieren

www.teamitaliailluminazione.it 

 Alimentatore non incluso - Power Supply not included - Netzteil nicht enthalten

BV	NE
<input type="checkbox"/>	<input type="checkbox"/>
	
	

* 4560lm effettivi - effective - effektive con - with - mit E2
4200lm effettivi - effective - effektive con - with - mit E19 ↻ +17,5%

 CODICE COMPLETO DEL PRODOTTO NELLA FOTO
FULL PRODUCT CODE AS SHOWN IN PICTURE - VOLLSTÄNDIGER CODE VOM ARTIKEL IM BILD

T028M48 **NE** **E2** **B**

Codice Code	Finitura Finishing Lackierung	Diffusore Diffuser Diffusor	Tonalità Hue Farbton
----------------	-------------------------------------	-----------------------------------	----------------------------

SISTEMA B48



configurazione standard: / basic configuration: / Standard Konfiguration:

E19 Prismatico - Prism

 B 3000K

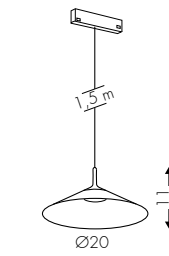

T071A48ONE19B

6.5W 800lm* - 48V DC

292,00 €

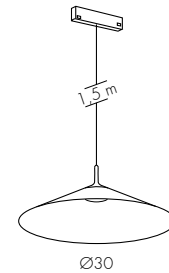

T071B48ONE19B

6.5W 800lm - 48V DC

372,00 €

Configura 

Configure / Konfigurieren

www.teamitaliailluminazione.it 



T071F48ONE19B

6.5W 800lm - 48V DC

292,00 €



T071G48ONE19B

6.5W 800lm - 48V DC

372,00 €



0074A2

Servizio doppia accensione
Dual switch service - Service Doppelzündung

50,00 €

Configura 

Configure / Konfigurieren

www.teamitaliailluminazione.it 



 CODICE COMPLETO DEL PRODOTTO NELLA FOTO
FULL PRODUCT CODE AS SHOWN IN PICTURE - VOLLSTÄNDIGER CODE VOM ARTIKEL IM BILD

T071A48

Codice
Code

ZN

Finitura
Finishing
Lackierung

E19

Diffusore
Diffuser
Diffusor

B

Tonalità
Hue
Farbton

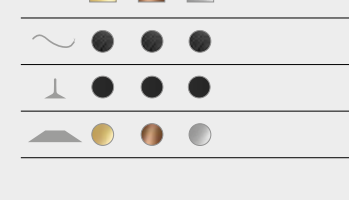

 Alimentatore non incluso - Power Supply not included - Netzteil nicht enthalten

* 800lm effettivi - effective - effektive con - with - mit **E19**

SISTEMA B48



configurazione standard: / basic configuration: / Standard Konfiguration:

E2 Opale - Opal ● B 3000K NT 

T073A48NTE2B 6.5W 800lm* - 48V DC **350,00 €**

[Configura](#)  Configure / Konfigurieren

www.teamitaliailluminazione.it 

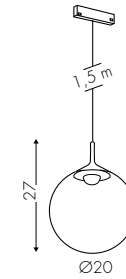

T073F48NTE2B 6.5W 800lm - 48V DC **350,00 €**

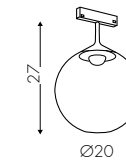

0074A2 Servizio doppia accensione **50,00 €**
Dual switch service - Service Doppelzündung

[Configura](#)  Configure / Konfigurieren

www.teamitaliailluminazione.it 



E2 Opale - Opal ● B 3000K NF 

 **CODICE COMPLETO DEL PRODOTTO NELLA FOTO**
FULL PRODUCT CODE AS SHOWN IN PICTURE - VOLLSTÄNDIGER CODE VOM ARTIKEL IM BILD

T073A48 **NF** **E2** **B**

Codice
Code

Finitura
Finishing
Lackierung

Diffusore
Diffuser
Diffusor

Tonalità
Hue
Farbton

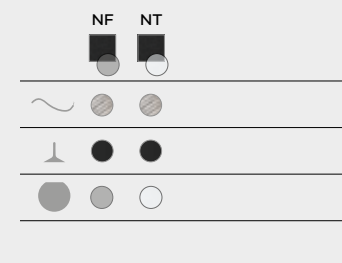

 Alimentatore non incluso - Power Supply not included - Netzteil nicht enthalten

* 800lm effettivi - effective - effektive con - with - mit **E2**

SISTEMA B48



configurazione standard: / basic configuration: / Standard Konfiguration:

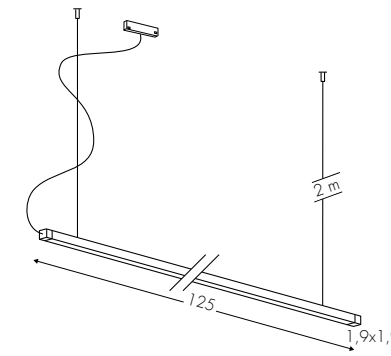

E2 Opale - Opal ● B 3000K

BV

T016B48BVE2B 28W 1890lm* - 48V DC

310,00 €



[Configura](#)  Configure / Konfigurieren

www.teamitaliailluminazione.it 

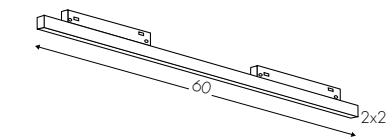

T016F48BVE2B 12W - 716lm - 48V DC

160,00 €



0074A2 Servizio doppia accensione
Dual switch service - Service Doppelzündung

50,00 €



[Configura](#)  Configure / Konfigurieren

www.teamitaliailluminazione.it 

NE

↑ CODICE COMPLETO DEL PRODOTTO NELLA FOTO
FULL PRODUCT CODE AS SHOWN IN PICTURE
VOLLSTÄNDIGER CODE VOM ARTIKEL IM BILD

T016B48 **NE** **E2** **B**

Codice Code	Finitura Finishing Lackierung	Diffusore Diffuser Diffusor	Tonalità Hue Farbton
----------------	-------------------------------------	-----------------------------------	----------------------------

BV NE

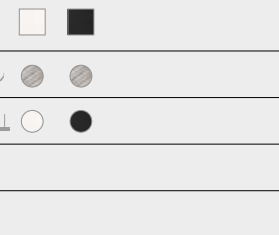

X Alimentatore non incluso - Power Supply not included - Netzteil nicht enthalten

*1890lm effettivi - effective - effektive con - with - mit E2



SISTEMA B48

LINEA DARK 

configurazione standard: / basic configuration: / Standard Konfiguration:

E19 Prismatizzato - Prism ● B 3000K BV

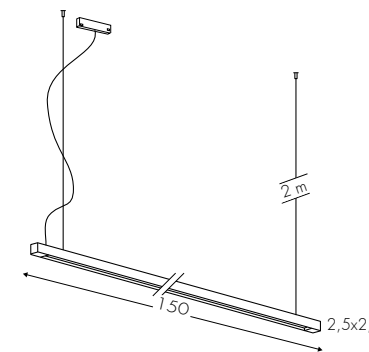

T021A48BVE19B 27W 2320lm* - 48V DC **362,00 €**

[Configura](#)  Configure / Konfigurieren

www.teamitaliailluminazione.it 

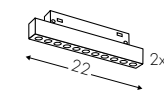

T021F48BVE19B 10W - 900lm - 48VDC **190,00 €**

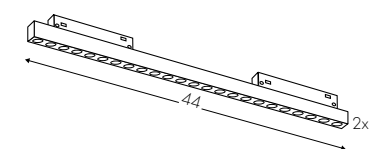

T021G48BVE19B 20W - 1800lm - 48V DC **278,00 €**



0074A2 Servizio doppia accensione / Dual switch service - Service Doppelzündung **50,00 €**

[Configura](#)  Configure / Konfigurieren

www.teamitaliailluminazione.it 



NE

 Alimentatore non incluso - Power Supply not included - Netzteil nicht enthalten

* 2320lm effettivi - effective - effektive con - with - mit E19

 **CODICE COMPLETO DEL PRODOTTO NELLA FOTO**
FULL PRODUCT CODE AS SHOWN IN PICTURE
VOLLSTÄNDIGER CODE VOM ARTIKEL IM BILD

T021A48 **NE** **E19** **B**

Codice Code	Finitura Finishing Lackierung	Diffusore Diffuser Diffusor	Tonalità Hue Farbton
----------------	-------------------------------------	-----------------------------------	----------------------------



 INDEX

 SECTION

 FAMILY 521



configurazione standard: / basic configuration: / Standard Konfiguration:

E2 Opale - Opal - Opal ● B 3000K



T1083A48BVE2B 6,5W 1000lm* - 48VDC

370,00 €

[Configura](#)  Configure / Konfigurieren

www.teamitaliailluminazione.it 

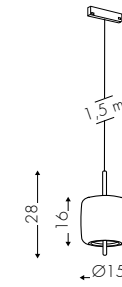

T3083A48BVE2B 6,5W 1000lm - 48VDC

370,00 €

0074A2 Servizio doppia accensione
Dual switch service - Service Doppelzündung

50,00 €

C005T2NE Custom black cable

8,00 € /MT

[Configura](#)  Configure / Konfigurieren

www.teamitaliailluminazione.it 



A

● A 2700K



CODICE COMPLETO DEL PRODOTTO NELLA FOTO
FULL PRODUCT CODE AS SHOWN IN PICTURE - VOLLSTÄNDIGER CODE VOM ARTIKEL IM BILD

T3083A48 **BV** **E2** **B**

Codice
Code

Finitura
Finishing
Lackierung

Diffusore
Diffuser
Diffusor

Tonalità
Hue
Farbton

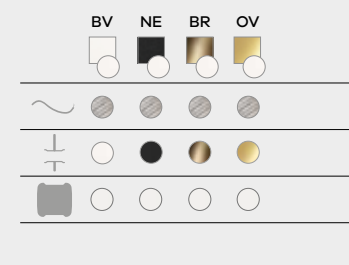

TF Taglio di Fase - Phase-Cut Dimmer - Phasenabschnittdimmer

A Alimentatore nel rosone - Power Supply inside the ceiling rose - Netzteil in der Deckendose

* 1000lm effettivi - effective - effektive con - with - mit **E2**

SISTEMA B48

MICRO 

configurazione standard: / basic configuration: / Standard Konfiguration:

24° Ottica - Optic - Optik  B 3000K 

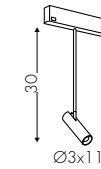

T039A48BV24B

3W 360lm* - 350mA - 48V DC

249,00 €

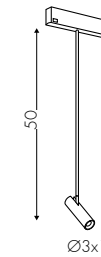

T039B48BV24B

3W 360lm - 350mA - 48V DC

249,00 €



0074A2

Servizio doppia accensione
Dual switch service - Service Doppelzündung

50,00 €

[Configura](#)  [Configure / Konfigurieren](#)

www.teamitaliailluminazione.it 



 Alimentatore non incluso - Power Supply not included - Netzteil nicht enthalten

* 360lm effettivi - effective - effektive con - with - mit 24°



 **CODICE COMPLETO DEL PRODOTTO NELLA FOTO**
FULL PRODUCT CODE AS SHOWN IN PICTURE - VOLLSTÄNDIGER CODE VOM ARTIKEL IM BILD

T039B48 **NE** **24** **B**

Codice
Code

Finitura
Finishing
Lackierung

Diffusore
Diffuser
Diffusor

Tonalità
Hue
Farbton

 [INDEX](#)

 [SECTION](#)

 [FAMILY](#) 525

SISTEMA B48



configurazione standard: / basic configuration: / Standard Konfiguration:

E2 Opale - Opal - Opal  B 3000K 

T1082A48BVE2B 6,5W 680lm* - 48VDC

310,00 €

[Configura](#)  Configure / Konfigurieren

www.teamitaliailluminazione.it 



T3082A48BVE2B 6,5W 680lm - 48VDC

310,00 €

0074A2 Servizio doppia accensione
Dual switch service - Service Doppelzündung

50,00 €

C005T2NE Custom black cable

8,00 € /MT

[Configura](#)  Configure / Konfigurieren

www.teamitaliailluminazione.it 



 A 2700K 

CODICE COMPLETO DEL PRODOTTO NELLA FOTO
FULL PRODUCT CODE AS SHOWN IN PICTURE - VOLLSTÄNDIGER CODE VOM ARTIKEL IM BILD

T3082A48 **NE** **E2** **B**

Codice
Code

Finitura
Finishing
Lackierung

Diffusore
Diffuser
Diffusor

Tonalità
Hue
Farbton

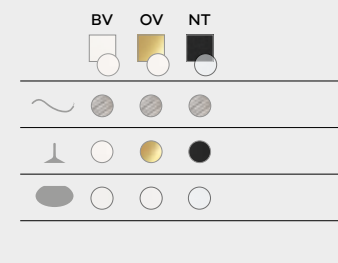

TF Taglio di Fase - Phase-Cut Dimmer - Phasenabschnittdimmer

A Alimentatore nel rosone - Power Supply inside the ceiling rose - Netzteil in der Deckendose

* 680lm effettivi - effective - effektive con - with - mit **E2**



RV custom finish

configurazione standard: / basic configuration: / Standard Konfiguration:

E28 Satinato
Frosted - Satiniert

B 3000K

BV

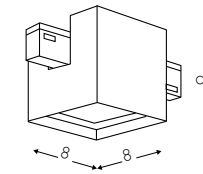

T009A48NEE28B

13W 1000lm* - 48V DC

199,00 €



0074A2

Servizio doppia accensione
Dual switch service - Service Doppelzündung

50,00 €

Configura 

Configure / Konfigurieren

www.teamitaliailluminazione.it 

NE RU 



 Alimentatore non incluso - Power Supply not included - Netzteil nicht enthalten

* 1000lm effettivi - effective - effektive con - with - mit **E28**

 **CODICE COMPLETO DEL PRODOTTO NELLA FOTO**
FULL PRODUCT CODE AS SHOWN IN PICTURE - VOLLSTÄNDIGER CODE VOM ARTIKEL IM BILD

T009A48 | **RV** | **E28** | **B**

Codice
Code

Finitura
Finishing
Lackierung

Diffusore
Diffuser
Diffusor

Tonalità
Hue
Farbton



SISTEMA B48

OVERLAP DECÒ

configurazione standard: / basic configuration: / Standard Konfiguration:

E2 Opale - Opal

B 3000K

BV

T015I48BVE2B

75W 5500lm* - 48V DC

780,00 €

Configura

Configure / Konfigurieren

www.teamitaliailluminazione.it

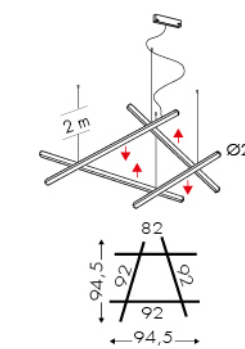
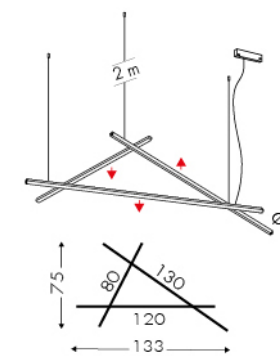

T015L48BVE2B

75W 5500lm - 48VDC

780,00 €

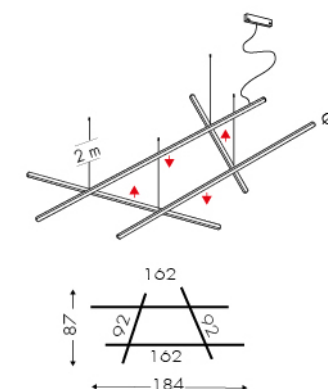

T015M48BVE2B

110W 8500lm - 48V DC

890,00 €



0074A2

Servizio doppia accensione
Dual switch service - Service Doppelzündung

50,00 €

Configura

Configure / Konfigurieren

www.teamitaliailluminazione.it



CODICE COMPLETO DEL PRODOTTO NELLA FOTO
FULL PRODUCT CODE AS SHOWN IN PICTURE - VOLLSTÄNDIGER CODE VOM ARTIKEL IM BILD

T015L48

RV

E2

B

Codice
Code

Finitura
Finishing
Lackierung

Diffusore
Diffuser
Diffusor

Tonalità
Hue
Farbton



Alimentatore non incluso - Power Supply not included - Netzteil nicht enthalten

* 5500lm effettivi - effective - effektive con - with - mit E2

SISTEMA B48



configurazione standard: / basic configuration: / Standard Konfiguration:

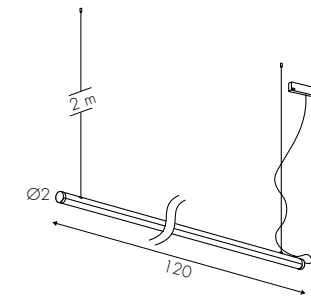

E2 Opale - Opal ● B 3000K BV

T015C48BVE2B 28W - 1890lm* - 48V DC

335,00 €

Configura  Configura / Konfigurieren

www.teamitaliailluminazione.it 

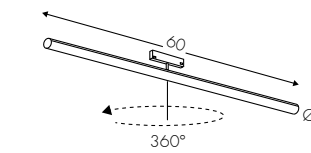

T015B48BVE2B 12W - 850lm - 48V DC

240,00 €



0074A2

Servizio doppia accensione
Dual switch service - Service Doppelzündung

50,00 €

Configura  Configura / Konfigurieren

www.teamitaliailluminazione.it 



 **CODICE COMPLETO DEL PRODOTTO NELLA FOTO**
FULL PRODUCT CODE AS SHOWN IN PICTURE - VOLLSTÄNDIGER CODE VOM ARTIKEL IM BILD

T015C48 **RV** **E2** **B**

Codice
Code

Finitura
Finishing
Lackierung

Diffusore
Diffuser
Diffusor

Tonalità
Hue
Farbton

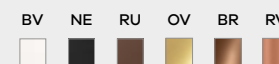

 Alimentatore non incluso - Power Supply not included - Netzteil nicht enthalten

* 1890lm effettivi - effective - effektive con - with - mit **E2**



configurazione standard: / basic configuration: / Standard Konfiguration:

E2 Opale - Opal B 3000K BV

T068B48BVE2B 49W 3440lm* - 48V DC **595,00 €**

T068C48BVE2B 66W 5630lm - 48V DC **695,00 €**

[Configura](#)  Configure / Konfigurieren

www.teamitaliailluminazione.it 

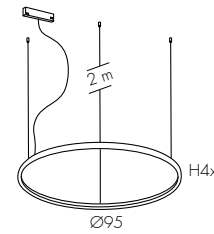
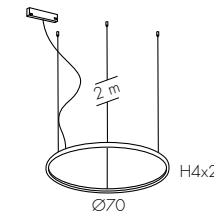

configurazione standard: / basic configuration: / Standard Konfiguration:

E2 Opale - Opal B 3000K BV

T068O48BVE2B 39W 2680lm - 48V DC **520,00 €**

T068E48BVE2B 49W 3440lm - 48V DC **695,00 €**

0074A2 Servizio doppia accensione / Dual switch service - Service Doppelzündung **50,00 €**

[Configura](#)  Configure / Konfigurieren

www.teamitaliailluminazione.it 

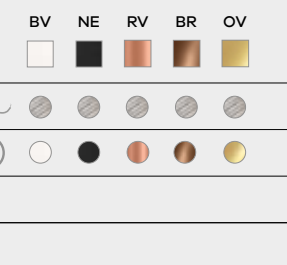
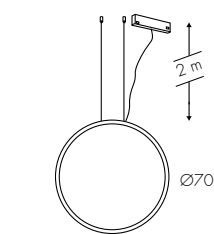
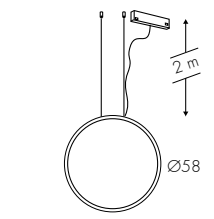

 Alimentatore non incluso - Power Supply not included - Netzteil nicht enthalten

* 3440lm effettivi - effective - effektive con - with - mit **E2**

 CODICE COMPLETO DEL PRODOTTO NELLA FOTO
FULL PRODUCT CODE AS SHOWN IN PICTURE - VOLLSTÄNDIGER CODE VOM ARTIKEL IM BILD

T068E48 **OV** **E2** **B**

Codice Code Finitura Finishing Diffusore Diffuser Tonalità Hue
Code Lackierung Diffusor Farbton

SISTEMA B48

SPOTLIGHT 



configurazione standard: / basic configuration: / Standard Konfiguration:

24° Ottica - Optic - Optik  B 3000K

BV

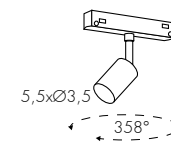

T018B48BV24B 4W 380lm* 48V DC

128,00 €

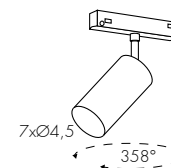

T018C48BV24B 7W 550lm 48V DC

131,00 €

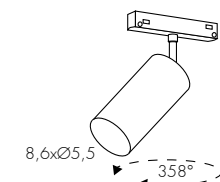

T018D48BV24B 12W 850lm 48V DC

145,00 €

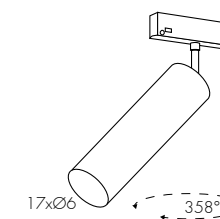

T018E48BV24B 18W 1280lm 48V DC

193,00 €



0074A2 Servizio doppia accensione
Dual switch service - Service Doppelzündung

50,00 €

Configura  Configure / Konfigurieren

www.teamitaliailluminazione.it 



NE

 **CODICE COMPLETO DEL PRODOTTO NELLA FOTO**
FULL PRODUCT CODE AS SHOWN IN PICTURE - VOLLSTÄNDIGER CODE VOM ARTIKEL IM BILD

T018C48 **NE** **24** **B**

Codice
Code

Finitura
Finishing
Lackierung

Diffusore
Diffuser
Diffusor

Tonalità
Hue
Farbton

 Alimentatore non incluso - Power Supply not included - Netzteil nicht enthalten

* 380lm effettivi - effective - effektiven con - with - mit 24°

 INDEX

 SECTION

 FAMILY 537

SISTEMA B48

TUBÍCO 



configurazione standard: / basic configuration: / Standard Konfiguration:

E8 Trasparente - Transparent  B 3000K 

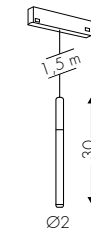

T069A48ONE8B

3W 350lm* - 48V DC

235,00 €

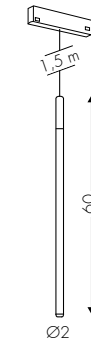

T069B48ONE8B

3W 350lm - 48V DC

252,00 €

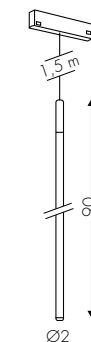

T069C48ONE8B

3W 350lm - 48V DC

265,00 €



0074A2

Servizio doppia accensione
Dual switch service - Service Doppelzündung

50,00 €

Configura  Configure / Konfigurieren

www.teamitaliailluminazione.it 





E19 

CODICE COMPLETO DEL PRODOTTO NELLA FOTO
FULL PRODUCT CODE AS SHOWN IN PICTURE
VOLLSTÄNDIGER CODE VOM ARTIKEL IM BILD

T069B48 ZN E19 B

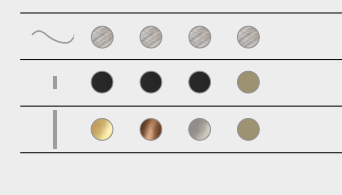
<p>Codice Code</p>	<p>Finitura Finishing Lackierung</p>	<p>Diffusore Diffuser Diffusor</p>	<p>Tonalità Hue Farbton</p>
------------------------	--	--	-------------------------------------



 Alimentatore non incluso - Power Supply not included - Netzteil nicht enthalten

* 350lm effettivi - effective - effektiven con - with - mit **E8**



 INDEX

 SECTION

 FAMILY 539

SISTEMA B48



configurazione standard: / basic configuration: / Standard Konfiguration:

E2 Opale
Opal - Opal

 B 3000K

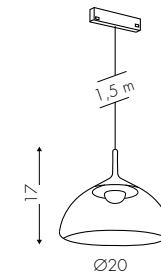

T064A48NTE2B

6.5W 800lm* - 48V DC

350,00 €

Configura 

Configure / Konfigurieren

www.teamitaliailluminazione.it 

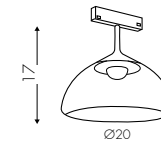

T064F48NTE2B

6.5W 800lm - 48V DC

350,00 €



0074A2

Servizio doppia accensione
Dual switch service - Service Doppelzündung

50,00 €

Configura 

Configure / Konfigurieren

www.teamitaliailluminazione.it 



 **CODICE COMPLETO DEL PRODOTTO NELLA FOTO**
FULL PRODUCT CODE AS SHOWN IN PICTURE - VOLLSTÄNDIGER CODE VOM ARTIKEL IM BILD

T064A48 **NF** **E2** **B**

Codice
Code

Finitura
Finishing
Lackierung

Diffusore
Diffuser
Diffusor

Tonalità
Hue
Farbton

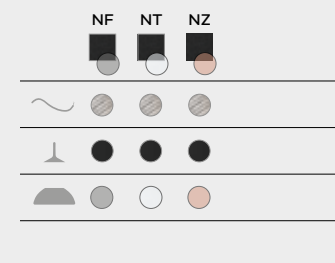

 Alimentatore non incluso - Power Supply not included - Netzteil nicht enthalten

* 800lm effettivi - effective - effektiven con - with - mit **E2**

Sistemi di Gestione della luce
Light Management Systems
Lichtsteuersysteme



 Dimmer BT

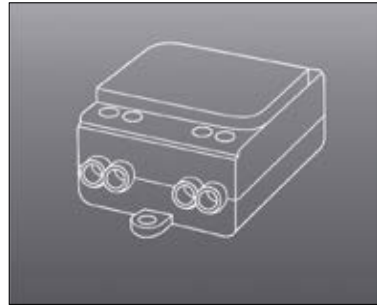

BLC 546
Bluetooth Light Control

 Dimmer Dali

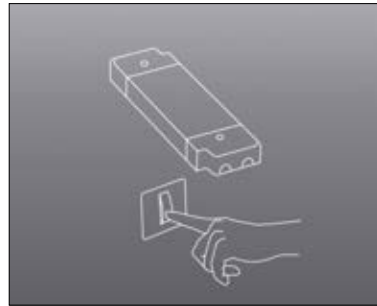

PLC 547
Push Light Control

 RLC



RLC Remote Light Control 548
Gestione della luce monocromatica



RLC Remote Light Control 548
Gestione della luce caldo/freddo



RLC Remote Light Control 548
Gestione della luce RGB

 WLC



WLC Wall Light Control 551
Sistema di gestione per scatola 503

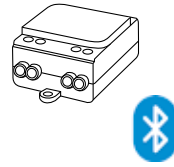

9010BTMD

Dispositivo Bluetooth per rendere dimmerabili Wireless da remoto i nostri prodotti in versione "DM" (DALI).
Our products DM dimmable (DALI) products are compatible with Tridonic module for remote bluetooth dimming.
Bluetooth-Gerät, um unsere "DM" (DALI) Produkte Wireless dimmbar zu machen.

163,00 €

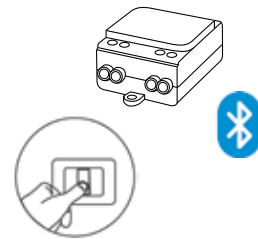

9010BTPD

Dispositivo per rendere Bluetooth un pulsante normalmente aperto.
Device to make Bluetooth a button normally open.
Gerät, um Bluetooth zu einer normalweise geöffneten Taste zu machen.

163,00 €

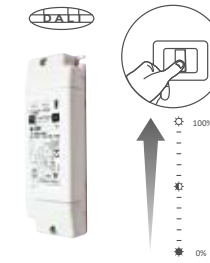
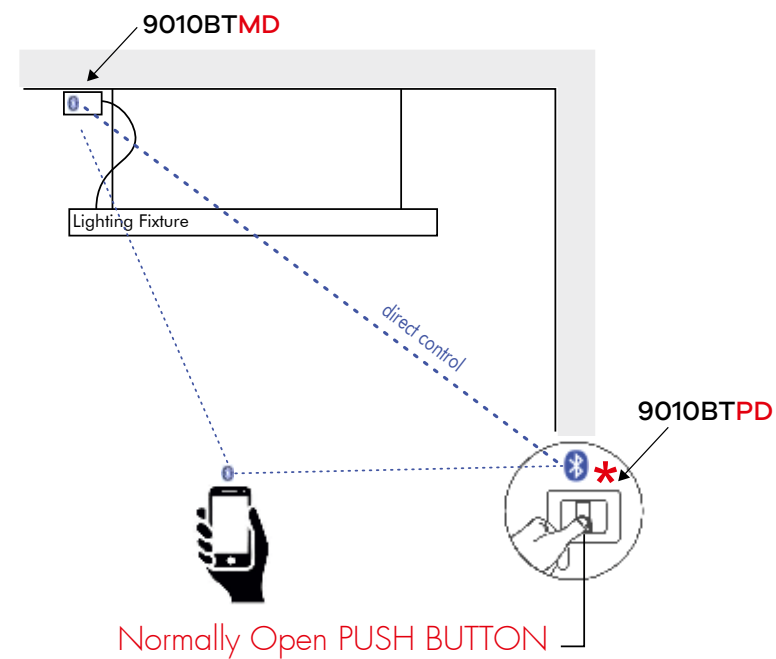

Max 10A 12/24VDC

90106002

Dispositivo per la gestione di sorgenti led a luce monocromatica con Pulsante o con sistema Domotico DALI.
Monochromatic led light manager with button or DALI domotic system.
Gerät für die Verwaltung von monochromatischem Led-Lichtquellen mit Druckknopfschaltung oder DALI Domotik.

79,00 €

Dispositivi necessari - Necessary devices - Notwendige Geräte



CODICE COMPLETO • COMPLETE CODE • VOLLSTÄNDIGE CODE

9010BTMD

Codice
Code

CODICE COMPLETO • COMPLETE CODE • VOLLSTÄNDIGE CODE

90106002

Codice
Code

Dispositivi necessari/Necessary Devices/
Notwendige Geräte

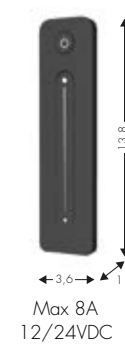
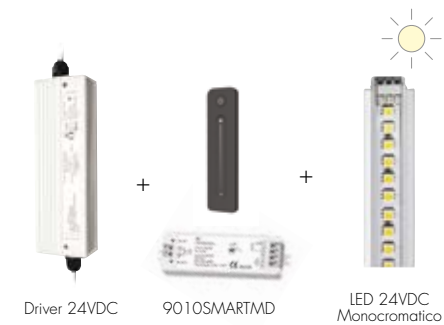

9010SMARTMD

Dispositivo per la gestione di sorgenti led a luce monocromatica con Radiocomando.

Monochromatic Led light remote control.
Gerät für die Verwaltung von monochromatischem Led-Lichtquellen mit Fernsteuerung.

74,00 €

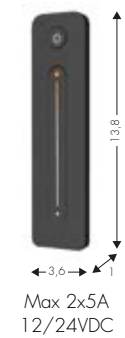

9010SMARTCW

Dispositivo per la gestione di sorgenti led a luce calda/fredda con Radiocomando.

Twin-white Led light remote control.
Gerät für die Verwaltung von Led Quellen zum warm bis kalt Licht mit Fernsteuerung.

86,00 €

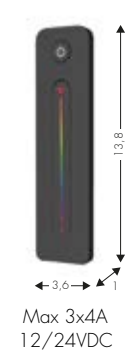

9010SMARTRGB

Dispositivo per la gestione di sorgenti led a luce RGB con Radiocomando.

RGB led light remote control.
Gerät für die Verwaltung von RGB Led-Lichtquellen mit Fernsteuerung.

86,00 €

CODICE COMPLETO • COMPLETE CODE • VOLLSTÄNDIGE CODE

9010SMARTMD

Codice
Code



9010MD2CH

494,00 €



Dimmerazione di 2 canali
Two channel dimming
Zwei Kanäle Dimmer

Dispositivi necessari - Necessary devices - Notwendige Geräte

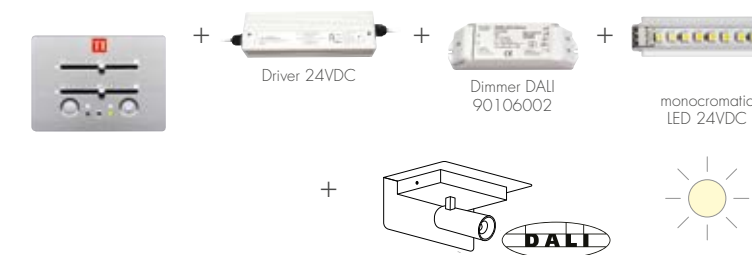

CODICE COMPLETO • COMPLETE CODE • VOLLSTÄNDIGE CODE

9010MD2CH

Codice
Code



9010CW

Dispositivo per la gestione di sorgenti LED a luce calda/fredda.
Twin-white LED light control device.
Gerät für die Verwaltung von LED Lichtquellen zum warm bis kalt.

494,00 €

Dispositivi necessari - Necessary devices - Notwendige Geräte



9010RGB

Dispositivo per la gestione di sorgenti LED a luce RGB.
RGB LED light control device.
RGB Lichtsteuergerät.

494,00 €

Dispositivi necessari - Necessary devices - Notwendige Geräte



CODICE COMPLETO • COMPLETE CODE • VOLLSTÄNDIGE CODE

9010CW

Codice
Code



9010SM

494,00 €



Dispositivo di coordinamento dei sistemi WallLight Control per la creazione di scenari luminosi. Per scatola 503.

WallLight control devices coordinator and scene manager. For 503 electric box.

Gerät, das die Wand-Managementsysteme koordiniert und Lichtszenen erstellt. Für 503 Gehäuse.

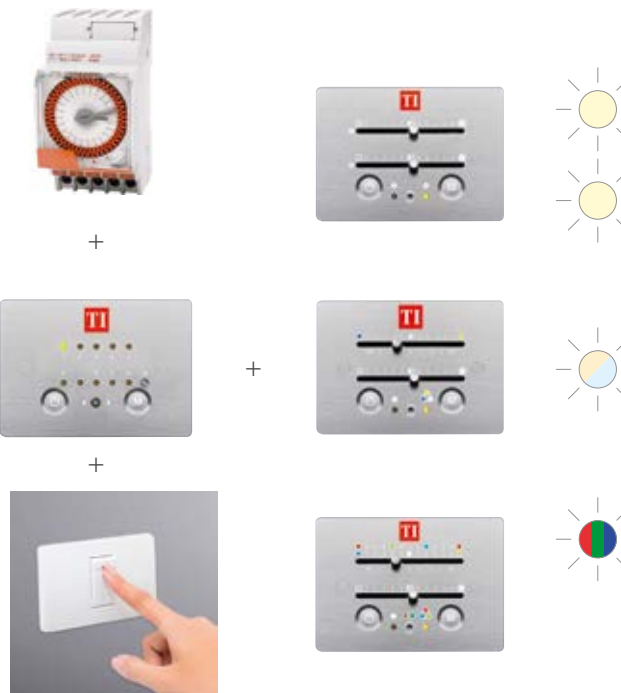

CODICE COMPLETO • COMPLETE CODE • VOLLSTÄNDIGE CODE

9010SM

Codice
Code

Accessori
Accessoires
Zubehör

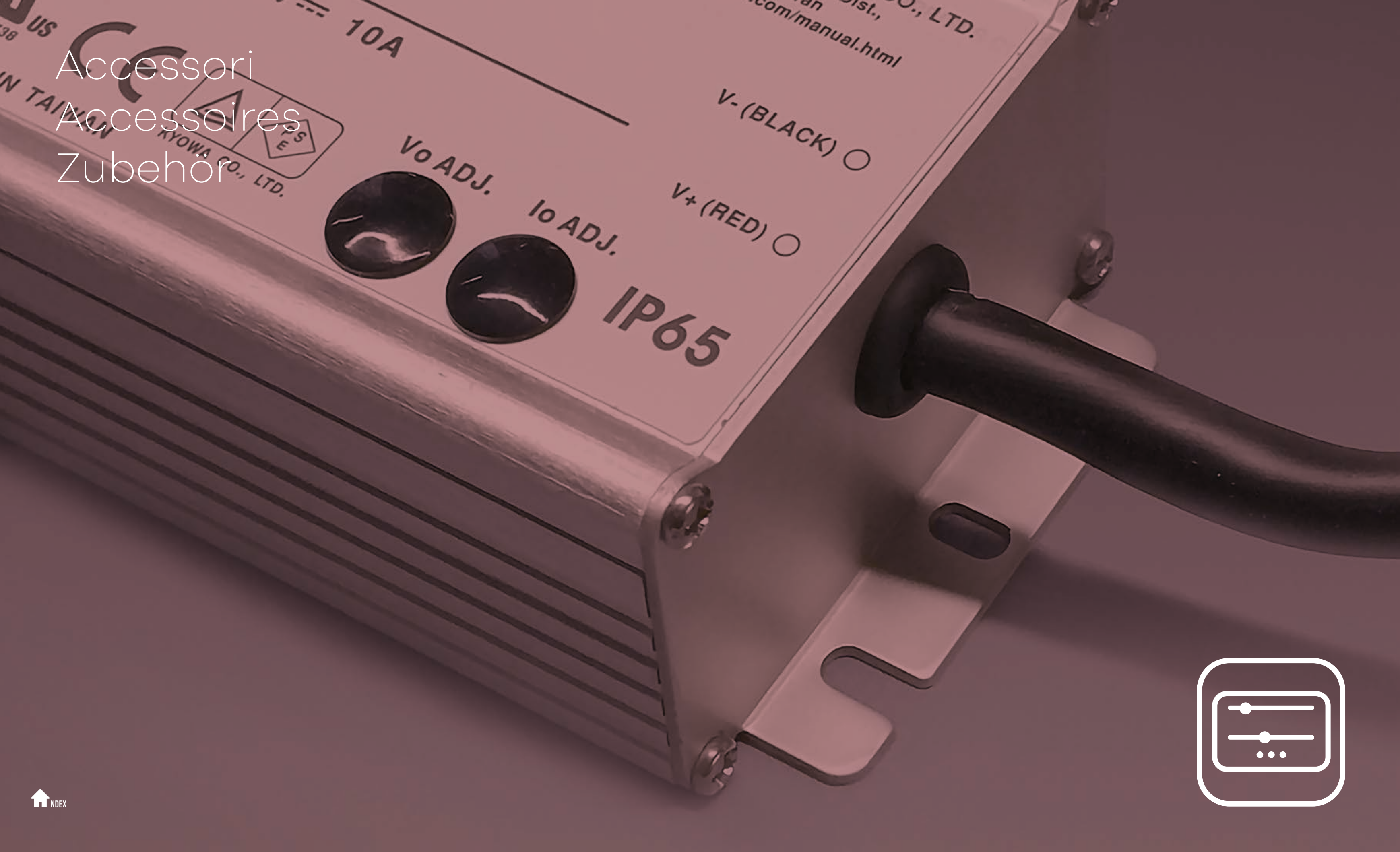

Striped

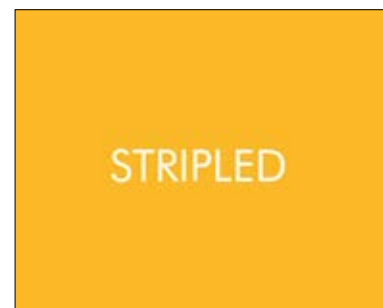

Stripled
stripled IP20 562



Stripled
stripled IP65 562

Drivers CC

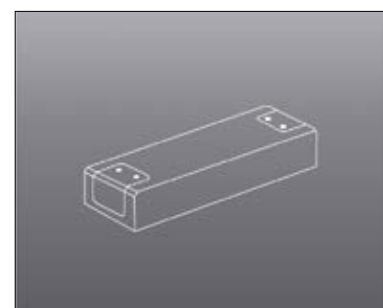

Alimentatori CC On/Off 564

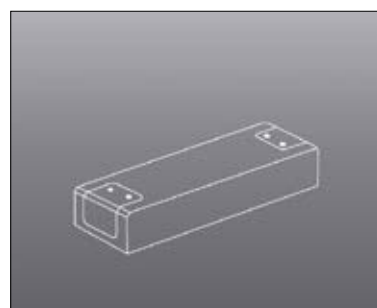

Alimentatori CC Triac 564

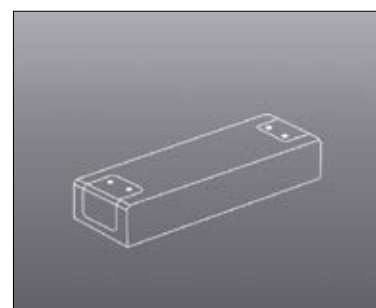

Alimentatori DALI (Push) 564

Drivers CV 24V

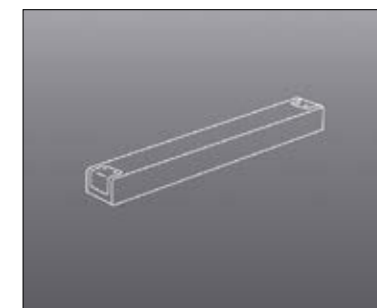

Alimentatori CV 24V On/Off 565

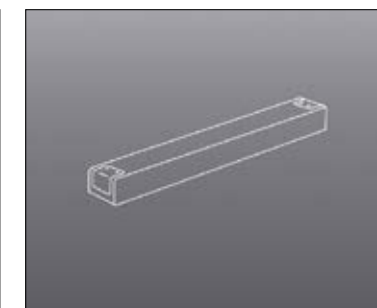

Alimentatori CV 24V Triac 565

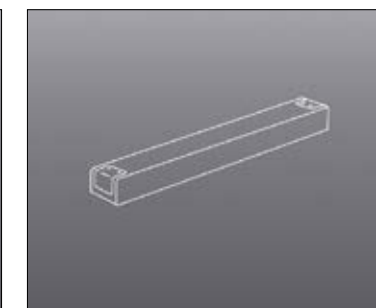

Alimentatori CV 24V DALI 565

Drivers CV 48V

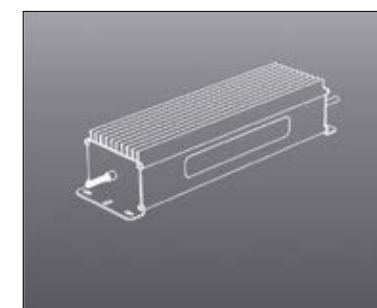

Alimentatori CV 48V Triac 565



Guidecavo

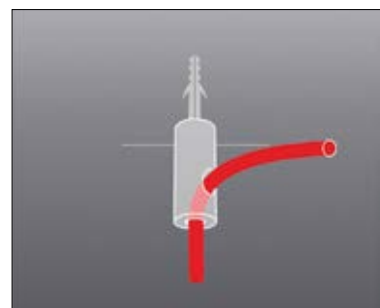

Guidecavo
Guide cavo verticale

567

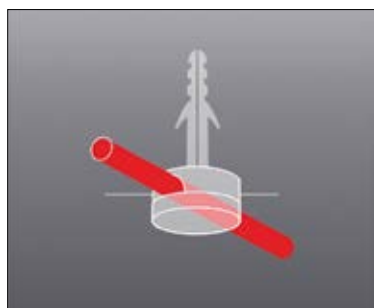

Guidecavo
Guide cavo orizzontale

567



Cavi alimentazione/Power cord



White
Cavi alimentazione in tessuto

567



Black
Cavi alimentazione in tessuto

567



Red
Cavi alimentazione in tessuto

567



Transparent
Cavi alimentazione in teflon

567



Rosoni / Canopy

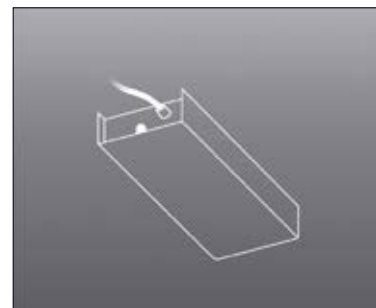

Rosoni

568

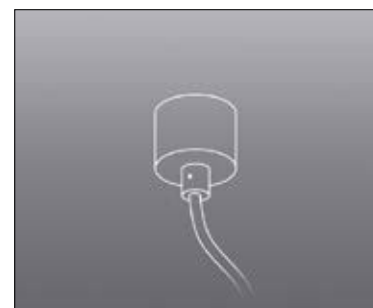

Rosoni

569

STRIPLED IP20

14.4W/mt



	90101427K20MT	14,4W 1900lm/mt - 24VDC 2700K IP20 (1mt)	13,00 € /mt + S.M.
	90101430K20MT	14,4W 1900lm/mt - 24VDC 3000K IP20 (1mt)	13,00 € /mt + S.M.
	90101440K20MT	14,4W 1900lm/mt - 24VDC 4000K IP20 (1mt)	13,00 € /mt + S.M.
	901014RGB20MT	14,4W 600lm/mt - 24VDC RGB IP20 (1mt)	14,00 € /mt + S.M.

Configura Configura / Konfigurieren www.teamitaliailluminazione.it

22W/mt



	90102227K20MT	22W 2880lm/mt - 24VDC 2700K IP20 (1mt)	32,00 € /mt + S.M.
	90102230K20MT	22W 2880lm/mt - 24VDC 3000K IP20 (1mt)	32,00 € /mt + S.M.
	90102240K20MT	22W 2880lm/mt - 24VDC 4000K IP20 (1mt)	32,00 € /mt + S.M.



Configura Configura / Konfigurieren www.teamitaliailluminazione.it

STRIPLED IP65

14.4W/mt



	90101427K65MT	14,4W 1900lm/mt - 24VDC 2700K IP65 (1mt)	15,00 € /mt + S.M.
	90101430K65MT	14,4W 1900lm/mt - 24VDC 3000K IP65 (1mt)	15,00 € /mt + S.M.
	90101440K65MT	14,4W 1900lm/mt - 24VDC 4000K IP65 (1mt)	15,00 € /mt + S.M.
	901014RGB65MT	14,4W 600lm/mt - 24VDC RGB IP65 (1mt)	16,00 € /mt + S.M.

Configura Configura / Konfigurieren www.teamitaliailluminazione.it

22W/mt



	90102227K65MT	22W 2880lm/mt - 24VDC 2700K IP65 (1mt)	37,00 € /mt + S.M.
	90102230K65MT	22W 2880lm/mt - 24VDC 3000K IP65 (1mt)	37,00 € /mt + S.M.
	90102240K65MT	22W 2880lm/mt - 24VDC 4000K IP65 (1mt)	37,00 € /mt + S.M.



Configura Configura / Konfigurieren www.teamitaliailluminazione.it

*SERVIZIO SU MISURA (S.M.)



001001A Taglio strip e saldatura - Cut service and soldering **12,00 €**

ROLLA 5MT IP20

14.4W/mt



	90101442700	14,4W 1900lm/mt - 24VDC 2700K IP20 (5mt)	60,00 €
	90101443000	14,4W 1900lm/mt - 24VDC 3000K IP20 (5mt)	60,00 €
	90101444000	14,4W 1900lm/mt - 24VDC 4000K IP20 (5mt)	60,00 €
	9010144RGB	14,4W 600lm/mt - 24VDC RGB IP20 (5mt)	66,00 €

Configura Configura / Konfigurieren www.teamitaliailluminazione.it

22W/mt



	9010222700	22W 2880lm/mt - 24VDC 2700K IP20 (5mt)	152,00 €
	9010223000	22W 2880lm/mt - 24VDC 3000K IP20 (5mt)	152,00 €
	9010224000	22W 2880lm/mt - 24VDC 4000K IP20 (5mt)	152,00 €



Configura Configura / Konfigurieren www.teamitaliailluminazione.it

ROLLA 5MT IP65

14.4W/mt



	90101442700IP65	14,4W 1900lm/mt - 24VDC 2700K IP65 (5mt)	72,00 €
	90101443000IP65	14,4W 1900lm/mt - 24VDC 3000K IP65 (5mt)	72,00 €
	90101444000IP65	14,4W 1900lm/mt - 24VDC 4000K IP65 (5mt)	72,00 €
	9010144RGBIP65	14,4W 600lm/mt - 24VDC RGB IP65 (5mt)	79,00 €

Configura Configura / Konfigurieren www.teamitaliailluminazione.it

22W/mt



	9010222700IP65	22W 2880lm/mt - 24VDC 2700K IP65 (5mt)	180,00 €
	9010223000IP65	22W 2880lm/mt - 24VDC 3000K IP65 (5mt)	180,00 €
	9010224000IP65	22W 2880lm/mt - 24VDC 4000K IP65 (5mt)	180,00 €



Configura Configura / Konfigurieren www.teamitaliailluminazione.it

CODICE COMPLETO • COMPLETE CODE • VOLLSTÄNDIGE CODE

4 X **90101427K20MT** + 1 X **001001A**
STRIPLED SERVICE

CODICE COMPLETO • COMPLETE CODE • VOLLSTÄNDIGE CODE

4 X **90101427K65MT** + 1 X **001001A**
ROLLA SERVICE

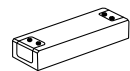

ON/OFF

AE006A	Driver 10W - On/Off 350mA / 35V / IP20	16,00 €
AE006B	Driver 16W - On/Off 350mA / 12-44V / IP20	28,00 €
AE006C	Driver 35W - On/Off 500mA / 50-100V IP20	26,00 €
AE006D	Driver 9W - On/Off 250mA / 5-36V IP20	22,00 €
AE006E	Driver 6W - On/Off 150mA / 5-40V IP20	22,00 €
AE006F	Driver 20W - On/Off 500mA / 12-44V IP20	27,00 €
AE006G	Driver 24W - On/Off 200-700mA / 3-42V IP20	35,00 €
AE006H	Driver 30W - On/Off 700mA / 20-42V IP20	31,00 €
AE006I	Driver 4W - On/Off 350mA / 3-12V / IP65	13,00 €
AE006L	Driver 10W - On/Off 350mA / 2-28,5V IP65	100,00 €
AE006M	Driver 18W - On/Off 350mA / 2-49V IP65	59,00 €
AE006N	Driver 34W - On/Off 300-700mA / IP20	30,00 €
AE006O	Driver 15W - On/Off 350-725mA / IP20	32,00 €

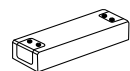

TRIAC

AE007F	Driver 25W - Triac 250-700mA / 15-49V IP20	56,00 €
AE008A	Driver 10W - Triac 350mA / 12-28V IP20	26,00 €
AE008B	Driver 18W - Triac 350mA / 25-51V IP20	26,00 €
AE008C	Driver 40W - Triac 350mA / 53-108V IP20	24,00 €
AE008D	Driver 10W - Triac 350mA / 3-42V IP20	18,00 €
AE008E	Driver 21W - Triac 300-500mA / 28-42V IP20	24,00 €
AE008F	Driver 20W - Triac 150-700mA / 7-44V IP20	44,00 €
AE008G	Driver 20W - Triac 180-350mA / 28-42V IP20	25,00 €
AE008H	Driver 20W - Triac 250-900mA / 15-48V IP20	46,00 €

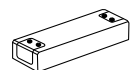

DALI (Push)

AE007A	Driver 30W - DALI(Push) 250-700mA / 2-54V IP20	65,00 €
AE007B	Driver 25W - DALI(Push) 350-1050mA / 20-50V IP20	62,00 €
AE007C	Driver 10W - DALI(Push) 150-400mA / 15-40V IP20	55,00 €
AE007E	Driver 38W - DALI(Push) 300-1050mA / 10-54V IP20	58,00 €

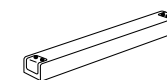

24V ON/OFF

AE003A	Driver 30W - On/Off 24V / IP20	29,00 €
AE003B	Driver 75W - On/Off 24V / IP20	45,00 €
AE003C	Driver 100W - On/Off 24V / IP65	74,00 €
AE003D	Driver 150W - On/Off 24V / IP65	98,00 €
AE003E	Driver 240W - On/Off 24V / IP65	127,00 €
AE003F	Driver 36W - On/Off 24V / IP20	34,00 €
AE003G	Driver 75W - On/Off 24V / IP65	52,00 €
AE003H	Driver 60W - On/Off 24V / IP20	38,00 €
AE003I	Driver 30W - On/Off 24V / IP65	47,00 €

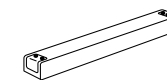

24V DALI

AE004A	Driver 150W - DALI (No-Push) 24V / IP65	113,00 €
---------------	---	-----------------



24V TRIAC

AE005A	Driver 100W - Triac 24V / IP20	124,00 €
AE005B	Driver 200W - Triac 24V / IP65	198,00 €

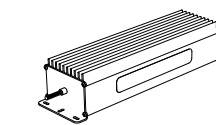

48V TRIAC

AE016A	Driver 100W - Triac 48V / IP65	230,00 €
AE016B	Driver 150W - Triac 48V / IP65	300,00 €



CODICE COMPLETO • COMPLETE CODE • VOLLSTÄNDIGE CODE

AE006I

Codice
Code

CODICE COMPLETO • COMPLETE CODE • VOLLSTÄNDIGE CODE

AE003A

Codice
Code



TR
□

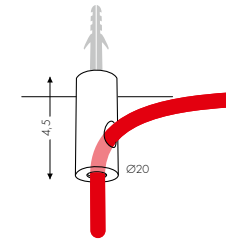

90106014

Guidacavi verticale
Vertical cable guide
Vertikal Kabelführung

13,00 €

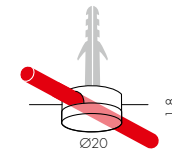

90106015

Guidacavi orizzontale
Horizontal cable guide
Horizontale Kabelführung

11,00 €

- C005T2NE Black cable **8,00 € /MT**
- C005T2BV White cable **8,00 € /MT**
- C005T2RO Red cable **8,00 € /MT**
- C005A2TR Transparent cable **7,00 € /MT**

CODICE COMPLETO • COMPLETE CODE • VOLLSTÄNDIGE CODE

90106014

Codice
Code



BV NE
□ ■

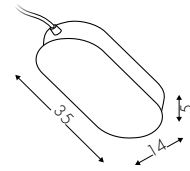

AM004A

Può contenere alimentatore: 75W
It can contains power supply: 100W
Es kann Netzteil enthalten: 150W
240W

68,00 €

75W + 90106002
100W + 90106002
150W + 90106002
240W + 90106002

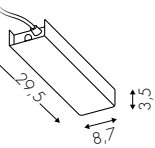

9010XS

Può contenere alimentatore: 30W/75W-24VDC
It can contains power supply: 30W/75W-24VDC
Es kann Netzteil enthalten: 30W/75W-24VDC

72,00 €

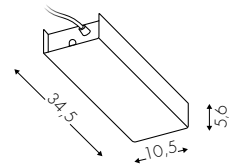

9010M

Può contenere alimentatore: 75W
It can contains power supply: 100W
Es kann Netzteil enthalten: 150W
240W

86,00 €

75W + 90106002
100W + 90106002
150W + 90106002
240W + 90106002

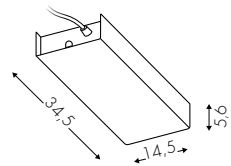

9010L

Può contenere alimentatore: 2x150W - 2x240W
It can contains power supply: 2x150W - 2x240W
Es kann Netzteil enthalten: 2x150W - 2x240W

97,00 €

BV NE
□ ■



AM003A

Solo collegamento elettrico rotondo
Only electrical connection round
Nur elektrische Verbindung runden

27,00 €

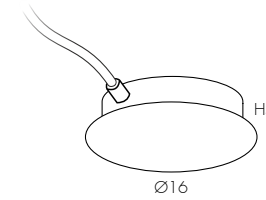

AM003B

Solo collegamento elettrico - può contenere bluetooth
Only electrical connection - can contain bluetooth
Nur elektrische Verbindung - kann Bluetooth enthalten

58,00 €

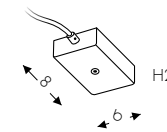

AM002A

Solo collegamento elettrico rettangolo
Only electrical connection rectangle
Nur elektrische Verbindung Rechteck

28,00 €

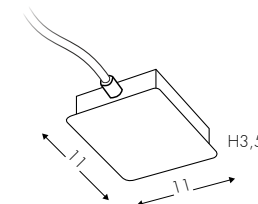

AM002B

Solo collegamento elettrico - può contenere bluetooth
Only electrical connection - can contain bluetooth
Nur elektrische Verbindung - kann Bluetooth enthalten

























28,00 €





CODICE COMPLETO • COMPLETE CODE • VOLLSTÄNDIGE CODE

9010XS **BV**

Codice
Code

Finitura
Finishing
Lackierung

	Superiore diffusa Diffused uplight Obere verbreitung		Inferiore dominante + Superiore diffusa Diffused main emission downlight + Uplight Geringere hauptunterdiffusion + Obere verbreitung
	Superiore asimmetrica diffusa Diffused asymmetrical uplight Obere asymmetrisch verbreitung		Superiore diffusa + Inferiore concentrata Diffused uplight + Diffused downlight Obere verbreitung + Geringere concentrates
	Superiore concentrata Accent uplight Obere concentrates		Inferiore diffusa + Superiore asimmetrica concentrata Diffused Downlight + Accent asymmetrical uplight Geringere verbreitung + Obere asymmetrisch concentrates
	Superiore asimmetrica concentrata Accent asymmetrical uplight Obere asymmetrisch concentrates		Superiore concentrata + Inferiore concentrata Accent uplight + Accent downlight Obere concentrates + Geringere concentrates
	Inferiore diffusa Diffused downlight Geringere verbreitung		Superiore + Inferiore + Frontale diffusa Diffuse up + down + frontal light Obere + Geringere + front verbreitung
	Inferiore asimmetrica diffusa Accent asymmetrical downlight Geringere asymmetrisch verbreitung		Inferiore + Laterale diffusa Diffused side + Downlight Obere asymmetrisch concentrates
	Inferiore concentrata Accent downlight Geringere concentrates		360° diffusa Diffused all side light Auf vier seiten diffuses
	Inferiore asimmetrica concentrata Accent asymmetrical downlight Geringere asymmetrisch concentrates		Orientabile diffusa Diffused adjustable Verstellbar verbreitung
	Frontale diffusa Diffuse frontlight Diffuse front		Orientabile concentrata Accent adjustable Verstellbar concentrates
	Superiore diffusa + Inferiore diffusa Diffuse up-downlight Oben-unten diffusion		Orientabile concentrata + Superiore diffusa Accent adjustable + Diffuse up Verstellbar concentrates + Obere
	Indiretta posteriore Indirect back Indirektes Heck		Laterale asimmetrico Lateral Asymmetric Seitliche asymmetrische
	Indiretta posteriore + frontale Indirect back + front Indirektes Heck + Front		Laterale simmetrica Lateral symmetric Seitlich symmetrisch

	Indica che un prodotto può circolare liberamente all'interno dell'Unione Europea: Certifica che il prodotto risponde ai requisiti essenziali di sicurezza. Indicates that the product can circulate freely within the European Union: Certifies that the product meets the essential safety requirements. Gibt an, dass ein Produkt innerhalb der Europäischen Union frei im Umlauf sein kann: Bescheinigt, dass das Produkt den wesentlichen Sicherheitsanforderungen entspricht.
	Contatto a terra. Apparecchio in classe prima dotato solo dell'isolamento. Ground contact. Fixture in first class equipped only with insulation. Erdung Gerät in Klasse 1 nur mit Isolierung ausgerüstet.
	Classe II doppio isolamento e/o isolamento rinforzato senza dispositivo di messa a terra. Double insulation and/or reinforced insulation in every part and without ground devices. Doppelte Isolierung, bzw verstärkte Isolierung der Teile, ohne Vorrichtung für Erdung.
	Classe di protezione III - Apparecchi con bassa tensione protettiva. Apparecchi con protezione dallo shock elettrico attraverso la bassa tensione protettiva e che non funzionano con tensioni superiori. Protection class III - Devices with extra-low voltage. Devices with protection from electric shock through the low-voltage protection. They don't work with higher voltages. Schutzklasse III - Leuchten mit Kleinspannung. Geräte mit Schutz vor Stromschlag durch die Niederspannung. Sie arbeiten nicht mit höheren Spannungen.
	Apparecchio adatto al montaggio su superfici normalmente infiammabili. Suitable for mounting on normally inflammable surface. Das Gerät ist zur Installation auf entflammable Oberflächen geeignet.
	Protezione contro corpi estranei di medie dimensioni, nessuna protezione contro la penetrazione di acqua. Protection against medium-sized foreign bodies, no protection against water penetration. Schutz gegen mittelgroße Fremdkörper, ohne Schutz gegen Eindringen von Wasser.
	Protetto contro la polvere. Protetto da spruzzi di ogni tipo. Protected from dust ingress. Protected from water spray from any direction. Staubgeschützt. Schutz gegen Spritzwasser.
	Totalmente protetto contro la polvere. Protetto contro i getti d'acqua con lanci da tutte le direzioni. Protected from total dust ingress. Protected from high pressure water jets from any direction. Staubdicht. Schutz gegen starkes Strahlwasser.
	Totalmente protetto contro la polvere. Protetto contro le ondate. Protected from total dust ingress. Protected from high pressure water jets from any direction. Staubdicht. Schutz gegen starkes Strahlwasser.
	Totalmente protetto contro la polvere. Protetto contro gli effetti di immersione. Protected from total dust ingress. Protected from waves. Staubdicht. Schutz gegen eintauchen.
	Protetto contro energia d'urto 2J. Protected against impact energy 2J. Geschützt gegen Aufprallenergie 2J.
	Protetto contro energia d'urto 5J. Protected against impact energy 5J. Geschützt gegen Aufprallenergie 5J.



A 2700K



B 3000K

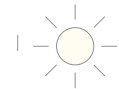

C 4000K

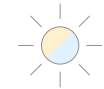

D 2700K-6500K



E RGB



Alimentatore Incorporato
Incorporated Power Supply
Eingebautes Netzteil



Alimentatore nel rosone
Power Supply inside the ceiling rose
Netzteil in der Deckendose



Alimentatore Incluso in remoto
Included Power Supply in remote
Einbezogen Netzteil



Alimentatore non incluso
Power Supply not included
Netzteil nicht inbegriffen



Sorgente GU10 non inclusa
GU10 light source not included
GU10 lichtquelle nicht einbezogen



Sorgente E27 non inclusa
E27 light source not included
E27 Lichtquelle nicht Enthalten

CAVO ALIMENTAZIONE
ELECTRIC CABLE - STROMKABEL

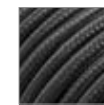

Nero - Black - Schwarz

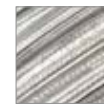

Trasparente - Transparent - Transparent



Rosso - Red - Rot



Bianco - White - Weiß

BV



Bianco
White
Weiß

NE



Nero
Black
Schwarz

RU



Ruggine
Rust
Rost

BF



Bronzo francese
French bronze
Französische Bronze

OS



Oro spazzolato
Brushed Gold
Gebürstetes Gold

OV



Oro verniciato
Painted gold
Gold lackiert

RV



Rame verniciato
Painted copper
Kupfer lackiert

BR

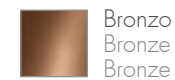

Bronzo
Bronze
Bronze

NT



Nero + Vetro trasparente
Black + Clear glass
Schwarz + Transparentem Glas

SV



Salvia
Sage
Salbei

ZN



Nero + Bronzo
Black + Bronze
Schwarz + Bronze

OB



Oro verniciato + Bianco
Brushed Gold + White
Gebürstetes Gold + Weiß

ON



Oro verniciato + Nero
Brushed Gold + Black
Gebürstetes Gold + Schwarz

RN



Rame verniciato + Nero
Painted copper + Black
Kupfer lackiert + Schwarz

BN



Nero + Bianco
Black + White
Schwarz + Weiß

AB



Argento + Bianco
Silver + White
Silber + Weiß

AB



Argento + Nero
Silver + Black
Silber + Schwarz

PN



Platino + Nero
Platin + Black
Platin + Schwarz

NF



Nero + Vetro fumè
Black + Smoky glass
Schwarz + Rauchglas

BY



Blu Navy
Navy Blue
Blu Navy

SN



Salvia + Nero
Sage + Black
Salbei + Schwarz

CB



Cromo + Bianco
Chrome + White
Chrom + Weiß

BO



Bianco + Ocre
White + Ochre
Weiß + Ocker

BS



Bianco + Salvia
White + Sage
Weiß + Salbei

BB



Bianco + Blu Navy
White + Navy Blue
Weiß + Blu Navy

AL



Alluminio
Aluminium
Aluminium

PL



Platino
Platinum
Platin

GV



Grigio verniciato
Painted Grey
Grau lackiert

NZ



Nero + Vetro bronzo
Black + Bronze glass
Schwarz + Glas bronze

OC



Ocre
Ochre
Ocker

PREZZI:

Unitari al pubblico **senza IVA (euro)**. I prezzi si intendono lampadine escluse, eccetto là dove specificatamente indicate incluse a listino.

ECOCONTRIBUTO RAEE:

In conformità alla direttiva che disciplina lo smaltimento di apparecchi elettrici ed elettronici (D.lgs 151/2005) si applica l'ecocontributo previsto dalla disposizione. Versati ove dovuti.

ORDINI:

Minimo l'ordine 200,00 (al netto di IVA e di sconti). L'accettazione è sempre soggetta all'approvazione della direzione con facoltà di effettuare spedizioni anche parziali, salvo esplicita indicazione da parte del committente.

TERMINI DI CONSEGNA:

I termini di consegna convenuti non sono impegnativi. Un eventuale ritardo non può dar luogo da parte del committente alla risoluzione dell'ordine, nè a qualsiasi pretesa di risarcimento danni. Team Italia ha la facoltà di sospendere la fornitura quando le condizioni economiche del cliente risultassero tali da porre in evidente pericolo il conseguimento del pagamento o per altri motivi di carattere commerciale e di gestione di Team Italia.

PORTO:

Porto franco per consegne di valore, al netto di IVA e di sconti, superiore a 600,00. (previo accordi)

GARANZIA

I prodotti Team Italia sono garantiti a norma di legge per due anni.

RECLAMI

I reclami per merce difettosa potranno essere accettati solo dietro la presentazione della copia del documento fiscale attestante l'acquisto e la corretta compilazione del modulo di reclamo da inviare entro 8 giorni dalla consegna del materiale. Team Italia si riserva il diritto di riparare e/o sostituire il prodotto difettoso con un altro prodotto simile o equivalente; sono esclusi costi di manodopera per la sostituzione degli apparecchi e comunque ogni danno, sia pure indirettamente, connesso con la difettosità dell'apparecchio.

RESI:

Eventuali resi dovranno essere da noi preventivamente autorizzati attendendosi alle istruzioni fornite.

MODIFICHE:

Fermo restando le caratteristiche basilari degli articoli, l'azienda si riserva di apportare eventuali modifiche per conformare alla normativa vigente e/o migliorare la qualità. Per ogni controversia è responsabile il Foro di Verona.

IL PRESENTE CATALOGO ANNULLA E SOSTITUISCE OGNI PRECEDENTE.

PRICES:

Unit prices for public **without VAT (euro)**. Prices do not include light bulbs, except where specifically indicated in the price list.

ORDERS:

Minimum order 200,00 net of VAT and discounts. Acceptance is always subject to approval by the management, who reserve the right to make split deliveries, except in the case of specific requirements set by the purchaser.

DELIVERY TERMS:

Agreed delivery deadlines are not binding. Eventual delays cannot be considered by the purchaser as a motive for withdrawing the order or for compensation for damages. Team Italia reserves the right to suspend shipments when the customer's financial conditions are such that payment of the invoice is at risk, or for other reasons based on Team Italia's commercial or management policies.

SHIPPING FEES:

Shipping costs, to be agreed, vary depending on the country of destination

WARRANTY:

Team Italia products are guaranteed for a period of 2 years.

CLAIMS:

Eventual claims or breakages must be reported within 8 days from the delivery of the goods. Claims for defective goods can only be considered, and the goods can be returned and repalced, only by presenting a copy of the fiscal document proving the relevant purchase, and filling the claim form supplied by Team Italia. Team Italia reserves the right to repair and/or replace the defective product with another similar or equivalent; Replacement labor costs of the devices are excluded and also any damage connected with the defectiveness of the device.

RETURNS:

Eventual returns must be authorised by us in advanced, in conformity with the instructions given.

MODIFICATIONS:

While the basic characteristics of the article remain unchanged, the company reserves the right to modify the products in order to conform with the regulations in force and/or to improve the quality. Any litigation will be dealt with by the Courts in Verona.

THE PRESENT CATALOG REPLACES ALL PREVIOUS ONES.

PREISE:

Einheitspreise **ohne MWVS (euro)**. Die preise verstehen sich ohne Glühbirnen, mit Ausnahme dort, wo sie im Verzeichnis ausdrücklich als inklusiv angegeben werden.

AUFTRÄGE:

Mindestauftrag Euro 200,00. Die Annahme ist immer vor der Zustimmung der Direktion abhängig mit der Befugnis, auch Teillieferungen vornehmen zu können, es sei denn, das ausdrückliche Hinweise seitens des Auftragsgebers bestehen.

LIEFERTERMINE:

Die vereinbarten Lieferungstermine sind unverbindlich. Eine eventuelle Verspätung gibt seitens des auftragsgebers weder anlass zur auftragsauflösung noch anspruch auf jeglichen Schadenersatz. Team Italia behält sich das Recht vor die Lieferung zu unterbrechen, sollte der finanzielle Zustand des Kunden die Zahlung offensichtlich gefährden oder aus anderen kommerzielle oder Leitungs-Gründen von Team Italia.

VERSANDKOSTEN:

Die zu vereinbarenden Versandkosten variieren je nach Bestimmungsland

GARANTIE:

Team Italia Produkte sind nach gesetzlichen Vorgaben 2 Jahre garantiert.

BESCHWERDEN:

Eventuelle Reklamationen oder Beschädigungen müssen nach Ablauf von 8 Tagen nach Warenerhalt schriftlich bekannt gegeben werden. Die Beschwerden für defekte Produkte können nur hinter Einreichung des Steuerbelegs, der den Kauf beschenigt, akzeptiert werden und nach der korrekten A5füllung des Beschwerdeformulars der innerhalb 8 Tagen nach der Lieferung der Produkten einzusenden ist. Team Italia behält sich das Recht vor die defekte Produkte zu reparieren und/oder sie mit anderen ähnliche oder gleichwertige Produkten zu ersetzen. Die Arbeitskosten für den Ersatz der Geräte sind nicht mit inbegriffen, sowal auch nicht jegliche Schaden die auch indirekt mit dem Defekt des Produktes verbunden sind.

RÜCKGABE DER WARE:

Eventuelle Warenrückgaben müssen von uns autorisiert werden, wobei man sich an die beigelegten Anweisungen halten sollte.

ÄNDERUNGEN:

Die grundlegenden Charakteristiken der Artikel bleiben erhalten, der Betrieb behält sich jedoch vor, eventuelle Änderungen vorzunehmen, um das Produkt den gültigen Normen anzupassen und/oder die Qualität zu verbessern. Für alle Rechtsfragen ist der Gerichtsstand Verona zuständig.

DIE VORLIEGENDE KATALOG ANNULLIERT UND ERSETZT ALLE VORHERGEHENDEN.

COPYRIGHTS

Le immagini inserite sono a scopo illustrativo. Le caratteristiche ed i colori possono differire da quanto rappresentato" (es. sul retro copertina).

The pictures are only for illustrative purposes. The features and colors may be different from what shown "(e.g. on the back cover).

Die Bilder werden zu Erläuterungszwecken enthalten. Die Eigenschaften und Farben können von diesen Darstellungen unterscheiden "(z. B. auf der Rückseite).

Tutti i diritti riservati. Nessuna parte del presente catalogo può essere riprodotta o diffusa con fotocopie, microfilm, o con qualsiasi altro mezzo senza il permesso del titolare del copyright.

All rights reserved. None of this catalogue may be reproduced or diffused in the form of photocopies, microfilm or by any other means without the permission of the copyright owner.

Alle Rechte sind vorbehalten. Es ist nicht gestattet, den vorliegenden Katalog durch Kopierung, Mikrofilme oder jeglicher anderer Mittel ohne die Erlaubnis des Copyrightberechtigten zu drucken oder aber in Umlauf zu bringen.

L'azienda si riserva il diritto in qualunque momento di apportare senza preavviso modifiche a prodotti ed accessori.

The company reserves the right at any time without prior notice to make changes to products and accessories.

Die Firma behält sich das Recht vor, jederzeit ohne vorherige Ankündigung Änderungen an Produkten und Zubehör zu machen.

coordinatori Maurizio Pisani/Alessandro Sbrozzeri
fotografia Massimo Branca
fotolitografia Eurotipo srl
illustrazioni Enrico Oliosì
progetto grafico Enrico Oliosì
stampa Eurotipo srl