

◇◇
UMAGE

FEELS LIKE HOME



*“ADD PERSONALITY AND
CHARACTER TO YOUR PROJECT
WITH DESIGNS FROM UIMAGE,
MAKING IT A PLACE THAT FEELS
LIKE HOME”*



MAKING AN EFFORT

Isn't it fascinating how powerful even the smallest of details can affect your impressions of great designs?

That's UIMAGE! A Danish word describing that extra effort you find in the details of our durable, functional and sustainable designs. And it works: UIMAGE is already present with our quality designs in more than 50 countries across the world.

Discover more at umage.com





HOSPITALITY 7

OFFICE 55

RESIDENTIAL 67

FAIRS 109

CONTRACT INFO 111

SUSTAINABILITY 112

DESIGNERS 118

PRODUCT INFO 121



HOSPITALITY

RESTAURANT 8

HOTEL 21

HOTEL ROOMS 22

LOUNGE AREAS 38

Asteria lamp, medium, anthracite grey



HOSPITALITY | RESTAURANT



Asteria floor lamp, anthracite grey
Asteria table lamp, pearl white

Bella Sky Copenhagen

Acorn lampshade, black, polished copper





Clava lampshade, brushed brass

Bash19 Copenhagen

Aluvia lampshade, mini, white
Champagne floor light stand, white



Höst

Aluvia lampshade, medium, anthracite grey



Höst

Time Flies chair, black, rusty brown
Clava Dine Wood lampshade, oak





Asteria lamp, medium, pearl white

Aarhus Theatre

Eos lampshade, large, light grey





Eos lampshade, medium, light brown
Tripod table light stand, white



Bella Sky Copenhagen



Asteria lamp, medium, black NEW
Time Flies chair, tweed, hazelnut

Bella Sky Copenhagen



HOSPITALITY

RESTAURANT 8

HOTEL 21

HOTEL ROOMS 22

LOUNGE AREAS 38

Eos lampshade, medium, white
Tripod floor light stand, black



Eos lampshade, mini, white
Champagne table light stand, brushed brass



Time Flies chair, brass, sand NEW





Eos lampshade, mini, light brown
Champagne table light stand, black
Audacious cabinet, oak, slate grey

Audacious tv bench, silver grey, oak
Seat Cushion
Asteria table lamp, pearl white



Bella Sky Copenhagen



Clava Up Wood lampshade, large, black oak **NEW**
A Conversation Piece tall lounge chair, black oak, teddy white **NEW**
Asteria Move lamp, black **NEW**

A **Conversation Piece** low lounge chair, oak, silver grey
Audacious side table, oak, silver grey
Asteria table lamp, pearl white



Bella Sky Copenhagen

Asteria table lamp w. USB-port

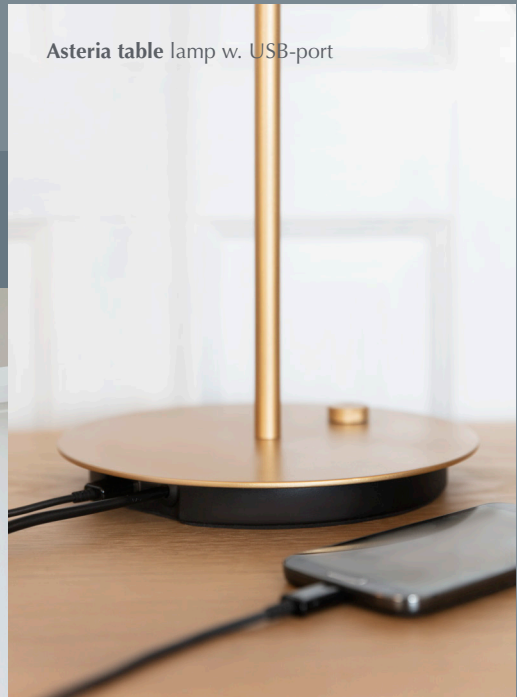

Eos lampshade, mini, light brown
Willow wall light stand, mini, white

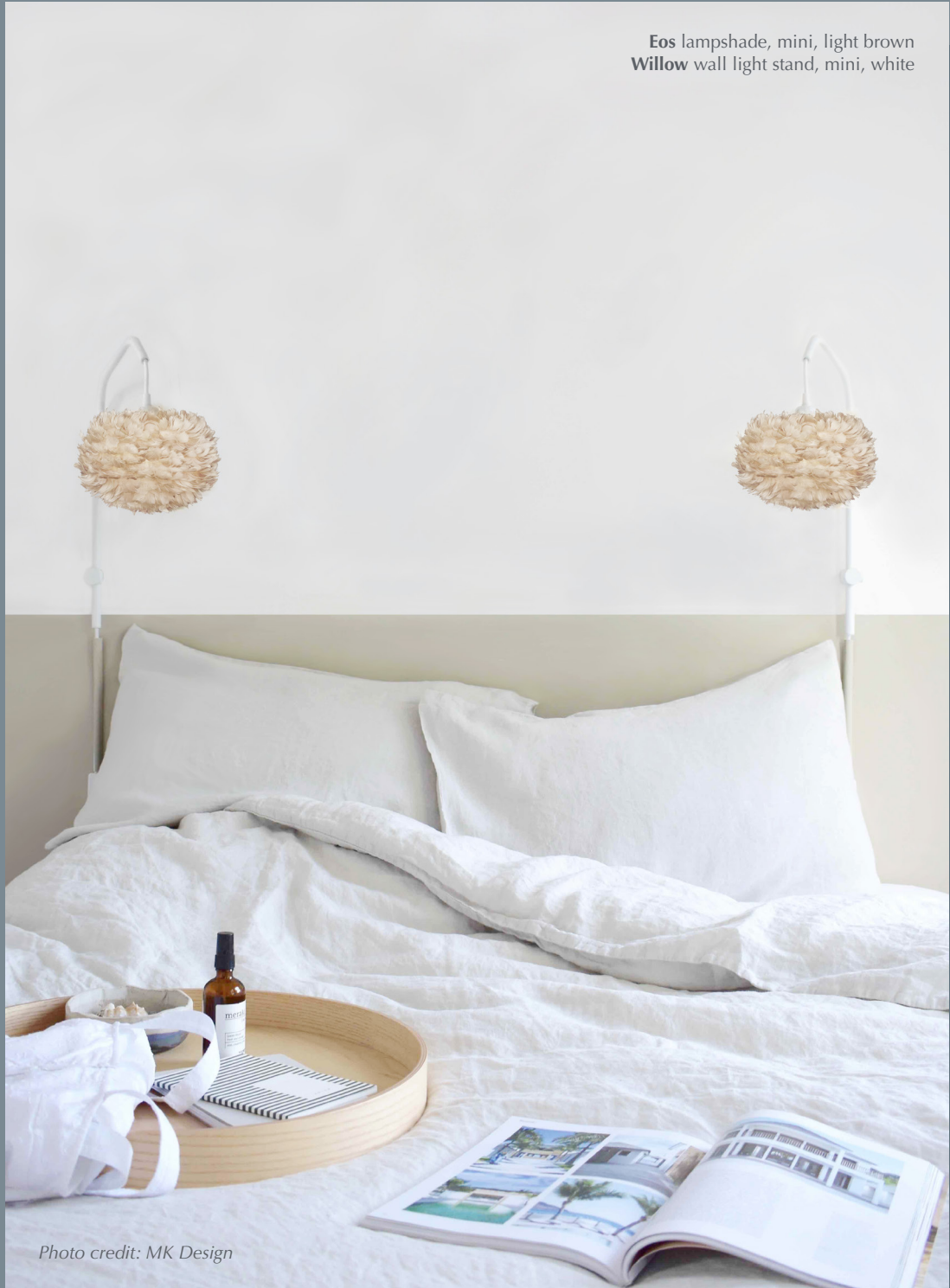

Photo credit: MK Design

One More Look mirror, pearl white, black oak **NEW**
Clava lampshade, white



HOSPITALITY | HOTEL | HOTEL ROOMS



Time Flies chair, black,
tweed, hazelnut
Asteria table lamp, pearl white
Ambitions desk, oak

Bella Sky Copenhagen

Audacious side table, silver grey, oak
Asteria table lamp, pearl white





Asteria lamp, medium, nuance orange **NEW**
My Spot side table, oak, brass



Audacious side table, oak, hazelnut **NEW**





HOSPITALITY

RESTAURANT 8

HOTEL 21

HOTEL ROOMS 22

LOUNGE AREAS 38

Asteria Move lamp, forest green NEW
Comfort Circle table, oak NEW



HOSPITALITY | HOTEL | LOUNGE AREAS

Aluvia lampshade, mini, pearl white
Stories shelving, oak. Brass plate & 3 trays in venetian cane incl.
Bowl for Stories
Round Corner Table for Stories, oak
Lounge Around sofa, oak
Round Table for Lounge Around, oak



The Reader wing chair, oak, Dunes leather, rust
The Reader ottoman, oak, Dunes leather, rust



Bella Sky Copenhagen

Audacious cabinet,
black oak, silver grey **NEW**
Asteria Move lamp,
pearl white **NEW**





Treasures 2-door cabinet, black oak, venetian cane NEW



The Reader wing chair, oak, spring green
Hang Out coffee table, oak, brass
Acorn lampshade, black, polished brass

KFI studios

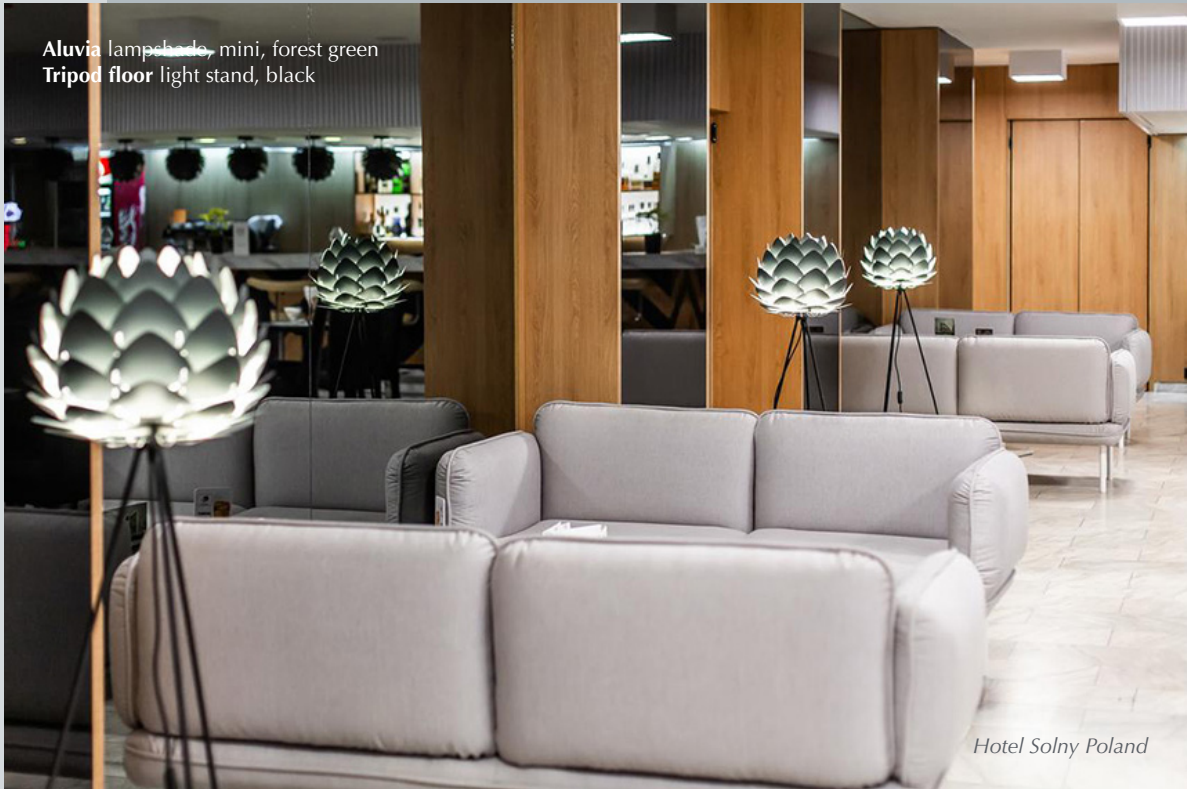

Aluvia lampshade, mini, forest green
Tripod floor light stand, black

Hotel Solny Poland



A Conversation Piece low lounge chair, oak, silver grey
The Reader wing chair, oak, silver grey
Hang Out coffee table, oak, steel
My Spot side table, oak, steel
Eos lampshade, medium, light grey
Champagne table light stand, brushed steel

Bella Sky Copenhagen

Eos Esther lampshade, large
Lounge Around sofa, oak
Round Table oak
Light Around light stand, white
Aluvia lampshade, mini, white





Bella Sky Copenhagen

The Reader wing chair, oak, silver grey
Hang Out coffee table, oak, brass

Eos lampshade, large, red **NEW**
Eos lampshade, medium, red **NEW**
A Conversation Piece low lounge chair, oak, silver grey

Den Frie Centre of Contemporary Art



HOSPITALITY | HOTEL | LOUNGE AREAS



Eos Evia lampshade, medium, white
Eos lampshade, large, light brown
Eos lampshade, medium, light brown
Eos lampshade, xx-large, white

Den Frie Centre of Contemporary Art



Asteria floor lamp, black NEW
Asteria lamp, medium, black NEW

HOSPITALITY | HOTEL | LOUNGE AREAS



Asteria table lamp, black NEW
My Spot side table, oak, brass
Asteria lamp, mini, black NEW

Cassini lamp, medium NEW





A **Conversation Piece** low lounge chair, dark oak, cream **NEW**
Asteria Move lamp, black **NEW**

Villa Copenhagen



OFFICE

Asteria Up lamp, anthracite grey
Asteria table lamp, forest green
The Reader wing chair, oak, Dunes leather, rust
Asteria floor lamp, pearl white
Chimes cluster 3 lamp, oak
Lean On Me clothes rack, black
Time Flies chair, brass, forest green, pale rose





One More Look mirror, pearl white, oak
The Reader wing chair, oak, dusty rose



My Spot side table, oak, brass
Lounge Around sofa 1.5-seater, oak
Asteria floor lamp, anthracite grey
A Conversation Piece low lounge chair, oak, silver grey



Clava Dine lampshade, black





Asteria Up lamp, anthracite grey
The Reader wing chair, oak, silver grey
Lean On Me clothes rack, black

Trays, 3 pieces, slate grey, felt **NEW**





Eos lampshade, xx-large, white



KPMG Copenhagen

OFFICE



Eos lampshade, x-large, white

Bella Sky Copenhagen



RESIDENTIAL

DINING 68

BEDROOM 80

LIVING ROOM 88

HALLWAY 98

Clava Dine Wood lampshade, black oak NEW



RESIDENTIAL | DINING



Chimes lamp, black oak

Asteria lamp, medium, petrol blue. Metal cover, medium, steel incl. **NEW**





Acorn lampshade, amber brass

Aluvia lampshade, mini & medium, brushed bronze NEW





Hazel lampshade, mini NEW

Asteria lamp, medium, nuance orange NEW
Time Flies chair, brass, sand NEW
Comfort Circle table, oak NEW











Eos lampshade, medium, light brown & large, white
Eos lampshade, mini, white
Tripod base light stand, black





Chimes tall lamp, oak NEW
My Spot side table, oak, brass



Flow shelf, black

Photo credit: Sariety.com



Eos Evia lampshade, medium & large, white



Eos Up lampshade, large
My Spot side table, oak, brass
Eos lampshade, mini, light brown
Tripod table light stand, white

Audacious cabinet, dusty rose, oak
Eos lampshade, medium, light rose



Asteria table lamp, ruby red





Audacious tv bench, hazelnut, oak **NEW**
Stories shelving, oak. Brass plate & 3 trays in venetian cane incl.
Extra Shelf for Stories, with hole, oak
Round Corner Table for Stories, oak
Bowl for Stories





A Conversation Piece tall lounge chair, oak, silver grey NEW
Audacious side table, oak, silver grey



Asteria Move lamp, pearl white NEW



Treasures 2-door cabinet, oak, venetian cane

Lounge Around sofa, oak
Round Table oak
My Spot side table, oak, brass
Clava Dine lampshade, red earth





Acorn lampshade, amber brass
Hang Out coffee table, black oak, brass **NEW**
A Conversation Piece low lounge chair, black oak, silver grey **NEW**

Eos lampshade, medium, light blue **NEW**
A Conversation Piece tall lounge chair, oak, teddy white **NEW**
Stories shelving, oak. Brass plate & 3 trays in venetian cane incl.
Trays for Stories, 3 pieces, venetian cane





The Reader wing chair, silver grey, oak
Jazz lampshade, oak
Champagne floor light stand, white



RESIDENTIAL

DINING 68

BEDROOM 80

LIVING ROOM 88

HALLWAY 98

Asteria Up lamp, pearl white
Teaser shelf, forest green
Teaser space rods
The Reader wing chair, slate grey, oak



Eos Up lampshade, mini, white **NEW**
Treasures cabinet, oak, venetian cane



Eos Esther lampshade, medium & large





Lean On Me clothes rack, white

Teaser shelf, saffron yellow

Butterflies hook, mini & medium, pearl white & saffron yellow



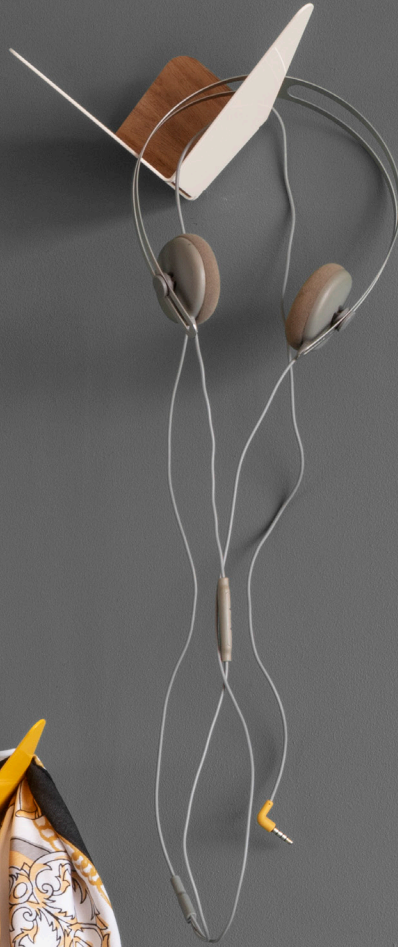
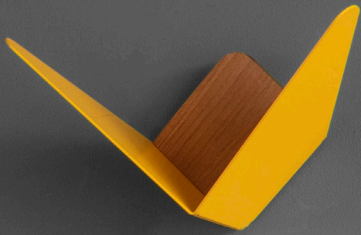

Audacious tv bench, petrol blue, oak
Champagne table light stand, brushed brass
Eos lampshade, medium, light grey



Butterflies hook, mini, ruby red & forest green



One More Look mirror, anthracite grey, oak
Lean On Me clothes rack, black









MAKING AN EFFORT FOR YOUR PROJECT

We offer:

Tested and certified designs

An extensive ready-to-ship collection

Made-to-order options from Kvadrat and Sorensen Leather

A responsible concept with a genuine care for the environment

Assembly service on request

Maintenance service for contract orders

Free access to CAD files through media kit at umagepress.com

Order our mobile showroom to pay you a visit, free of charge,
to study the designs up close

For more information contact info@umage.com



SUSTAINABLE SUSTAINABILITY EFFORTS

We are dedicated to being sensible frontrunners on the environmental responsibility. If we provide timeless, lasting and functional quality designs, we know nature will prevail, as will UIMAGE.



GIVING BACK TO NATURE

We acknowledge that selling furniture and lighting can never be 100% sustainable, but we want to make an extra effort for the environment. We have made a collaboration with the NGOs One Tree Planted, so every time one of our designs made from wood is sold, we are planting a tree. Furthermore, every time you buy one of our polypropylene lampshades from our website, we are donating 5% of the product value to the NGO Plastic Change, supporting the World ocean clean-up and minimising plastic pollution.

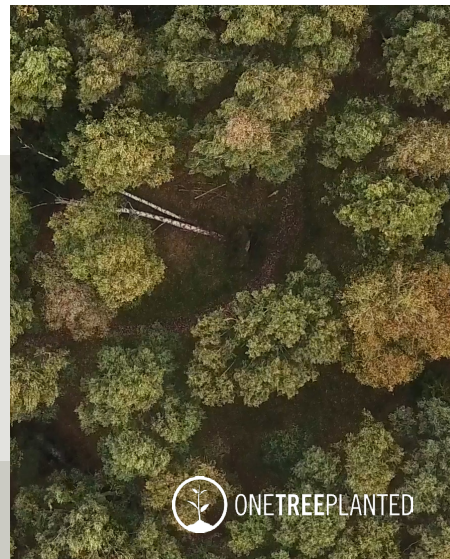

DURABLE QUALITY MATERIALS

We always choose quality materials to ensure prolonged lifecycles of our designs, so you can lead a sustainable lifestyle with care for the environment.

INTERCHANGEABLE ELEMENTS

As the times change, the designs can change accordingly. Two years have passed, and suddenly you want leather on your dining chairs instead of velour, then simply interchange the velour with leather in a few minutes. Same thing with our lounge chairs, cabinets, and other responsible designs. This means that you can add new life to the design and your interior without having to buy an entirely new furniture piece, saving the world resources.

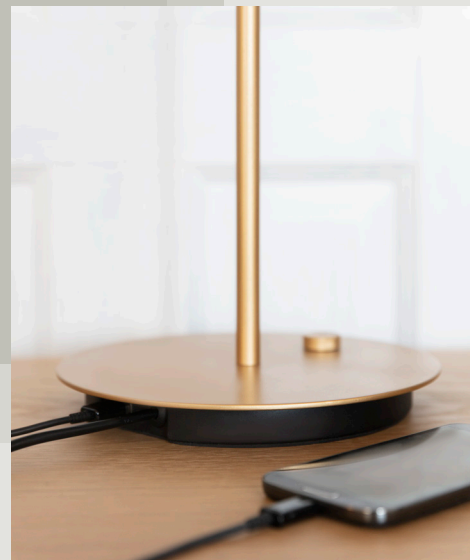

MULTIFUNCTIONAL AND FLEXIBLE

Why have a table lamp or a side table and not include a USB or wireless charger as well? Why not make room for storage where the space is vacant anyway? UIMAGE not only answers these questions but make it happen. One of the key aspects of the furniture and lighting designs at UIMAGE is multiple functions and flexibility. Designing with more than one function in mind is a sustainable mindset as it reduces the number of products you need to buy to get a complete setting for your space.



COMPACT AND REUSABLE PACKAGING

To minimise the packaging waste, we have devised a new packaging concept repurposing the packaging to be used as beautiful storage boxes afterwards, without any branding. We are replacing all foam and plastic in our packaging with eco-friendly materials to minimise the plastic waste when purchasing an UIMAGE design. This is being implemented continuously from January 2020.



RECYCLING

All designs can be separated into key elements for recycling, and worn parts can be replaced, to extend the life of the designs.

Get detailed information about our sustainability concept at umage.com/sustainability

MEET THE DESIGNERS

At UIMAGE we have a unique and dedicated inhouse design team, making an extra effort to create designs that will make a difference to us all. They will never design a new chair for the sake of the design; they want to make sure that the design will add extra value, whether it's a new dimension of flexibility, functionality or sustainability.





Søren Ravn
Christensen
Chief Creative Developer



Anders
Klem



Jonas
Søndergaard

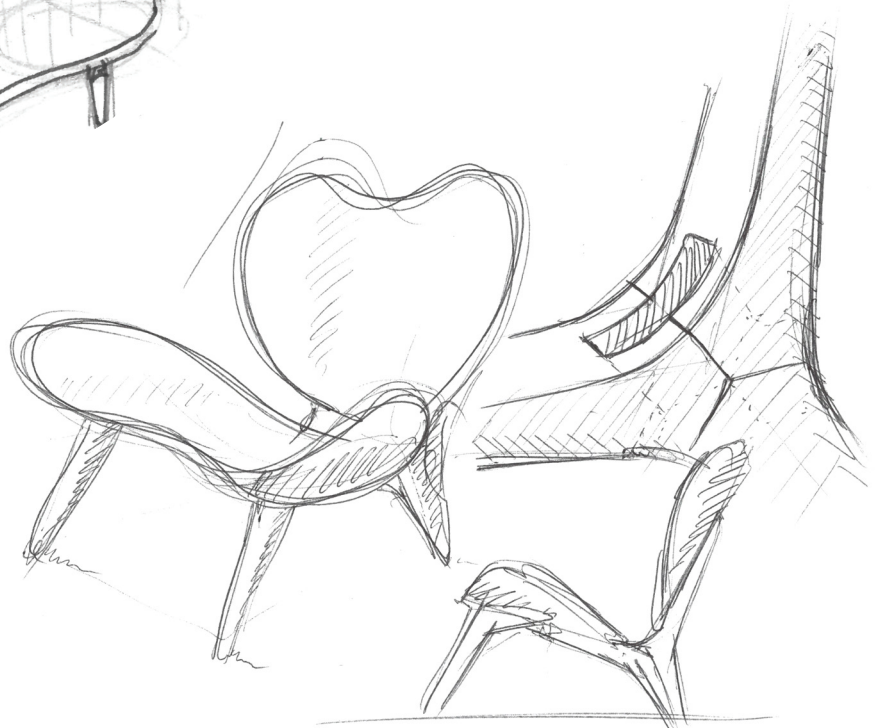
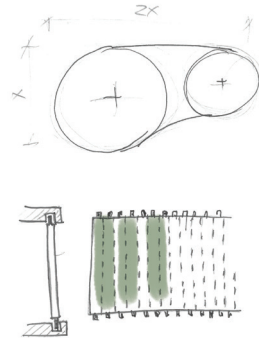
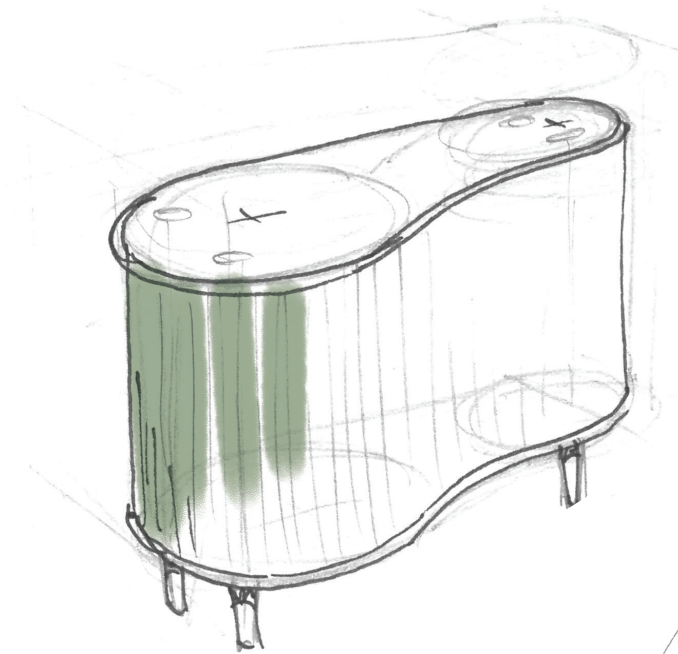

We collaborate with a great selection of external international designers, that share our passion for the Nordic design traditions. All our external designs are managed by the inhouse design team ensuring a coherent design selection.

Read more about the designers at umage.com/designers





Tor
Hadsund



Lasse
Sortkjær



Jacob Johan
Würtzen



Makers With
Agendas



Miklos
Leits



Jacob
Rudbeck



Lorenzo
Radaelli



Asger Risborg
Jacobsen



Magnus
Nero



Ingemar
Jönsson





PRODUCT INFO

LIGHTING 122

FURNITURE 194

FABRIC 256

ITEM INFO 264

COLLECTION INDEX 282

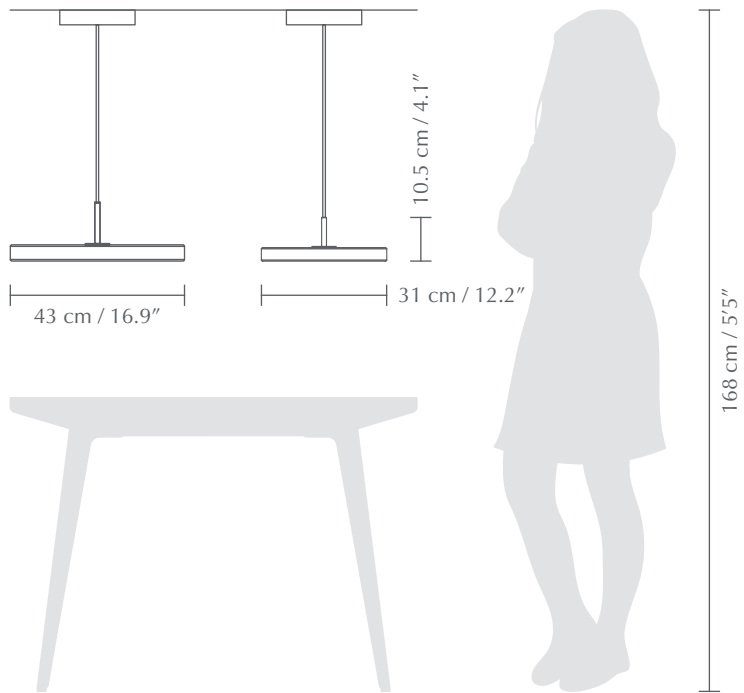
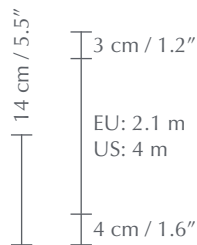
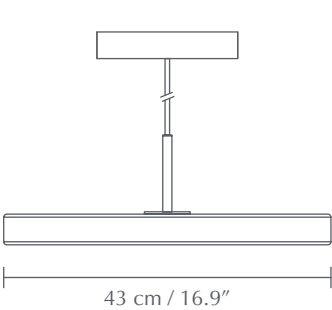
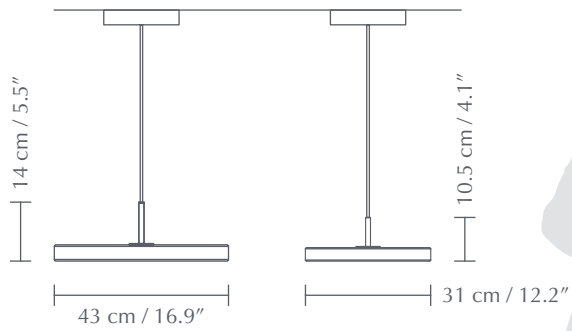
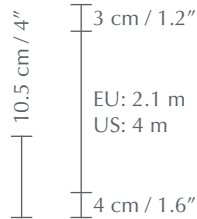
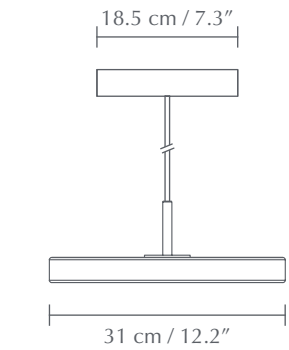

ASTERIA

Designed by Søren Ravn Christensen

AIM FOR THE STARS WITH ASTERIA

Born at the crossroads of design, technology and craftsmanship, this lamp incorporates built-in LED lights into a sleek, minimalist shape, echoing a design from the future and for the future. Asteria is ideal above the kitchen counter or the dining table and goes well in pairs of two.

Find more inspiration at page 8, 15, 19, 35, 50, 51, 70, 74, 76, 77

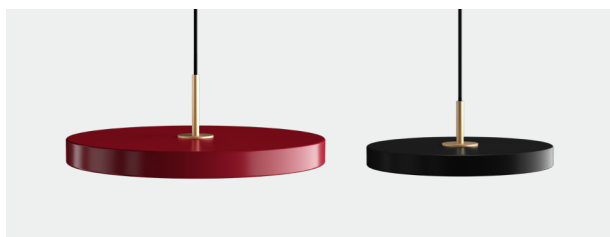

ORDERING INFORMATION

Medium pearl white	EU/UK/APAC #2170 / US #2176
Medium anthracite grey	EU/UK/APAC #2171 / US #2177
Medium forest green	EU/UK/APAC #2172 / US #2178
Medium petrol blue	EU/UK/APAC #2173 / US #2179
Medium ruby red	EU/UK/APAC #2174 / US #2180
Medium saffron yellow	EU/UK/APAC #2175 / US #2181
Medium black	EU/UK/APAC #2182 / US #2183
Medium nuance mist	EU/UK/APAC #2420 / US N/A
Medium nuance olive	EU/UK/APAC #2421 / US N/A
Medium nuance rose	EU/UK/APAC #2422 / US N/A
Medium nuance orange	EU/UK/APAC #2423 / US N/A
Mini pearl white	EU/UK/APAC #2206 / US #2176
Mini anthracite grey	EU/UK/APAC #2207 / US #2177
Mini forest green	EU/UK/APAC #2208 / US #2178
Mini petrol blue	EU/UK/APAC #2209 / US #2179
Mini ruby red	EU/UK/APAC #2210 / US #2180
Mini saffron yellow	EU/UK/APAC #2211 / US #2181
Mini black	EU/UK/APAC #2222 / US #2273
Mini nuance mist	EU/UK/APAC #2430 / US N/A
Mini nuance olive	EU/UK/APAC #2431 / US N/A
Mini nuance rose	EU/UK/APAC #2432 / US N/A
Mini nuance orange	EU/UK/APAC #2433 / US N/A



Pendant lamp



TESTS & CERTIFICATIONS

CE (for indoor use), IP2X, UL / cUL certified



DIMENSIONS (Ø x H)

Asteria medium: 43 cm / 16.9" x 4 cm (14 cm) / 1.6" (5.5")
Asteria mini: 31 cm / 12.2" x 4 cm (10.5 cm) / 1.6" (4.1")



MATERIAL

Steel, Aluminium and Acrylic
EU: Incl. 2.7 m black textile cord and metal canopy
US: Incl. 4 m black textile cord and metal canopy



WARRANTY

10 years warranty against manufacturer defects



WEIGHT INCL. PACKAGING

Asteria medium: 4.7 kg / 10.4 lb
Asteria mini: 2.6 kg / 5.7 lb



LIGHT SOURCE

Asteria medium:

EU: 16W LED panel built-in. 3000 K - 1300 lm. RA: ≥80
25000 H

US: 17W LED panel built-in. 3000 K - 1500 lm. RA: ≥80
25000 H

Asteria mini:

EU: 14W LED panel built-in. 900 K - 1200 lm. RA: ≥80
25000 H

US: 13W LED panel built-in. 3000 K - 1000 lm. RA: ≥80
25000 H

Dimmable with external dimmer*



PACKAGING (L x W x H)

Asteria medium: 46.9 x 53.8 x 9.6 cm / 18.5 x 21.2 x 3.8"
Asteria mini: 34.9 x 45.1 x 8.9 cm / 13.7 x 17.8 x 3.5"



ASSEMBLY TIME

10 min - video guide at umage.com



MEDIA KIT

Photos and press material
Download at umagepress.com

Colour variations

* For recommended external dimmers, go to umagepress.com



pearl
white

(RAL: 9001)



anthracite
grey

(RAL: 7016)



forest
green

(RAL: 6004)



petrol
blue

(RAL: 3025)



ruby
red

(RAL: 3032)



saffron
yellow

(RAL: 1004)



black

(RAL: 9005)



nuance
mist

(RAL: 7047)



nuance
olive

(RAL: 7042)



nuance
rose

(RAL: 3014)



nuance
orange

(RAL: 2010)

NEW



ASTERIA - METAL COVER

Designed by Søren Ravn Christensen

*Exchange the brass parts on the Asteria pendants for steel or black in minutes to create a new look and style for the design and find the perfect match for your home. This product is available from batch no. 20-26184-2172 of the Asteria mini and medium lamps.

Find more inspiration at page 70



DIMENSIONS

Mini: Ø: 6.3 cm / 2.4" H: 7.2 cm / 2.8"
Medium: Ø: 6.3 cm / 2.4" H: 10 cm / 3.9"



MATERIAL

Steel & Aluminium



WARRANTY

10-years warranty against manufacturer defects



WEIGHT INCL. PACKAGING

Mini: 2.6 kg / 5.7 lb
Medium: 3.8 kg / 8.4 lb



PACKAGING DIMENSIONS (L x W x H)

Mini: 12.1 x 13.8 x 1.9 cm / 4.7 x 5.4 x 0.7 "
Medium: 138 x 138 x 19 cm / 5.4 x 5.4 x 0.7"



MEDIA KIT

Photos and press material
Download at umagepress.com



ORDERING INFORMATION

Asteria mini steel metal cover	EU/UK/APAC #4174
Asteria medium steel metal cover	EU/UK/APAC #4172
Asteria mini black metal cover	EU/UK/APAC #4175
Asteria medium black metal cover	EU/UK/APAC #4173

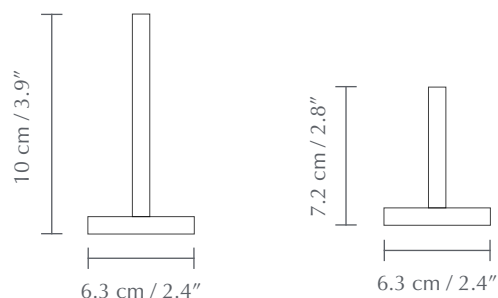

COLOUR VARIATIONS



steel



black



ASTERIA FLOOR

Designed by Søren Ravn Christensen

A TIGHT AND SLEEK EXPRESSION

The Asteria floor is born at the crossroads of design, technology and craftsmanship. It incorporates a built-in LED technology with a shape so minimal that it will never go out of style.

The LED panel is dimmable and has a white diffuser ensuring a soft illumination in the surrounding space. The brass stem going through the floor lamp as a vertical axis, reinforces a tight expression and by turning the top part of the stem you easily turn the light on and off.

Find more inspiration at page 9, 50, 57, 59



Floor lamp

TESTS & CERTIFICATIONS
CE (for indoor use), IP2X, cETLus certified

DIMENSIONS
Ø: 43 cm / 16.9" x H: 150.7 cm / 4'9"

MATERIAL
Steel, Aluminium and Acrylic
Incl. 2 m / 6'6" black cord

WARRANTY
10-years warranty against manufacturer defects

WEIGHT INCL. PACKAGING
9.3 kg / 20.5 lb

LIGHT SOURCE
24W LED panel built-in. 3000 K - 1100 lm. RA: >80
Dimmable. 25000 H

PACKAGING DIMENSIONS (L x W x H):
45 x 45 x 13 cm / 17.7 x 17.7 x 5"

ASSEMBLY TIME
15 min - video guide at umage.com

MEDIA KIT
Photos and press material
Download at umagepress.com

ORDERING INFORMATION

Asteria floor pearl white	EU/UK/APAC #2337 / US #3018
Asteria floor antracite grey	EU/UK/APAC #2338 / US #3019
Asteria floor forest green	EU/UK/APAC #2339 / US #3020
Asteria floor ruby red	EU/UK/APAC #2341 / US #3022
Asteria floor black	EU/UK/APAC #2340 / US #3028

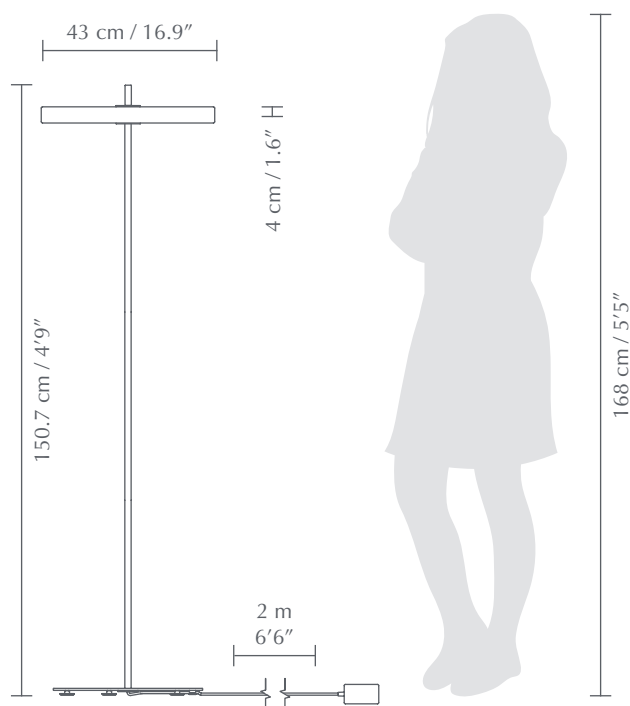

COLOUR VARIATIONS



pearl white
(RAL: 9001)



anthracite grey
(RAL: 7016)



forest green
(RAL: 6004)



ruby red
(RAL: 3032)

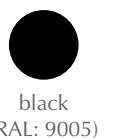

black
(RAL: 9005)

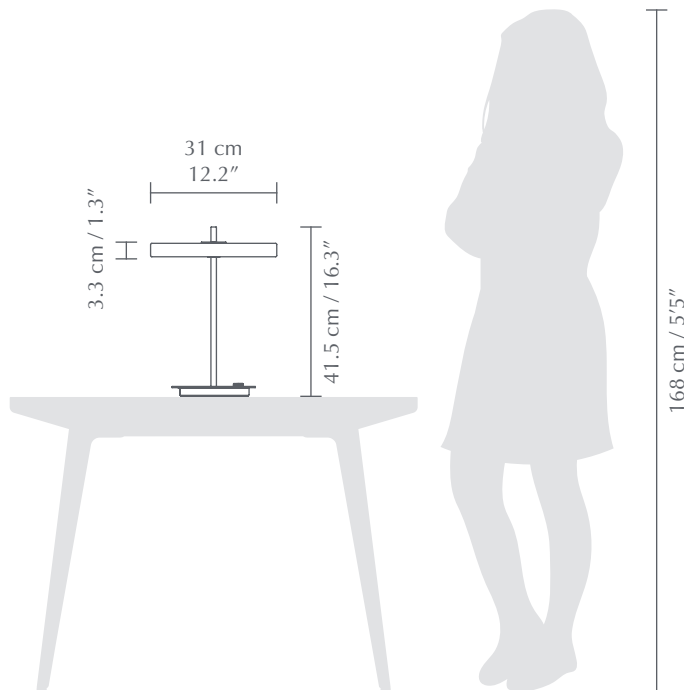
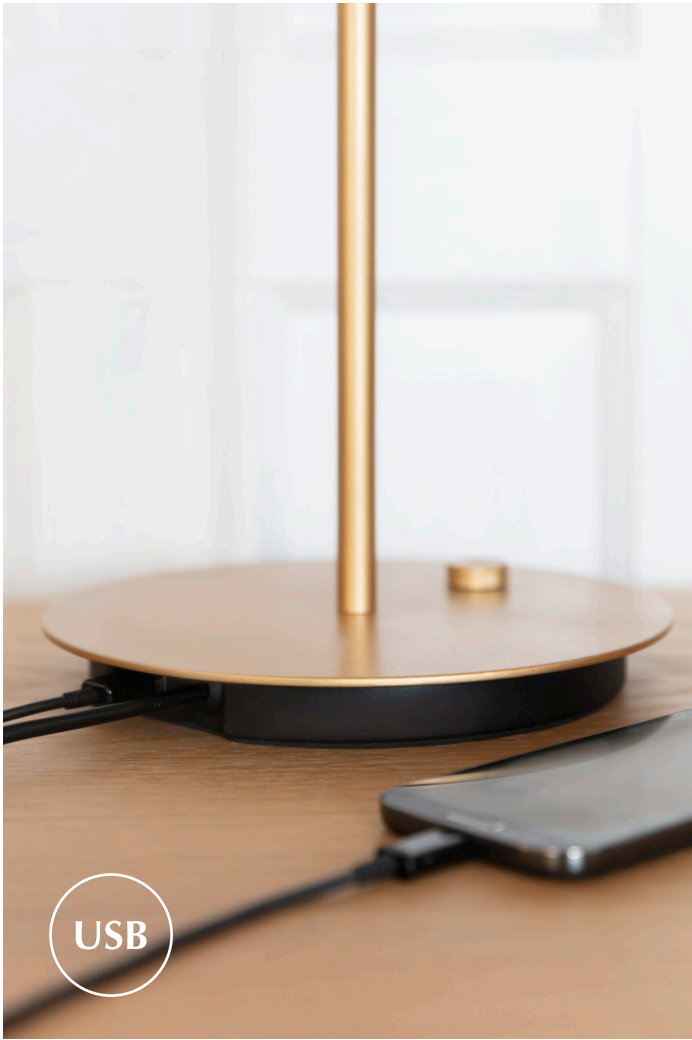

ASTERIA TABLE

Designed by Søren Ravn Christensen

ADD MINIMALISM TO THE TABLE

Asteria table has a built-in LED panel with a diffuser ensuring a soft illumination in the room. The brass stem going through the table lamp as a vertical axis, reinforces a tight and sleek expression. Asteria table has a hidden USB-port, so you can charge your phone – even when the light is turned off. The lamp is ideal on the desk or as a bedside table lamp but will add elegance to every corner of the home.

Find more inspiration at page 9, 26, 28, 31, 32, 33, 51, 56, 85



Table lamp



CERTIFICATION

CE (for indoor use), IP2X, cETLus certified



USB-port incl.



DIMENSIONS

Ø: 31 cm / 12.2" x H: 41.5 cm / 16.3"



MATERIAL

Polypropylene, Steel, Aluminium and Acrylic
Incl. 2 m / 6'6" black cord



WARRANTY

10-year warranty against manufacturer defects



WEIGHT INCL. PACKAGING

3.1 kg / 6.8 lb



LIGHT SOURCE

13W LED panel built-in. 3000 K - 600 lm. RA: >80
Dimmable. 25000 H



PACKAGING DIMENSIONS (L x W x H)

33.6 x 54.6 x 5.6 cm / 13.2 x 21.5 x 2.2"



ASSEMBLY TIME

5 min - video guide at umage.com



MEDIA KIT

Photos and press material
Download at umagepress.com



ORDERING INFORMATION

Asteria table pearl white EU/UK/APAC #2305 / US #2311
Asteria table anthracite grey EU/UK/APAC #2306 / US #2312
Asteria table forest green EU/UK/APAC #2307 / US #2313
Asteria table ruby red EU/UK/APAC #2309 / US #2314
Asteria table black EU/UK/APAC #2308 / US #2310

COLOUR VARIATIONS



pearl white
(RAL: 9001)



anthracite grey
(RAL: 7016)



forest green
(RAL: 6004)



ruby red
(RAL: 3032)



black
(RAL: 9005)

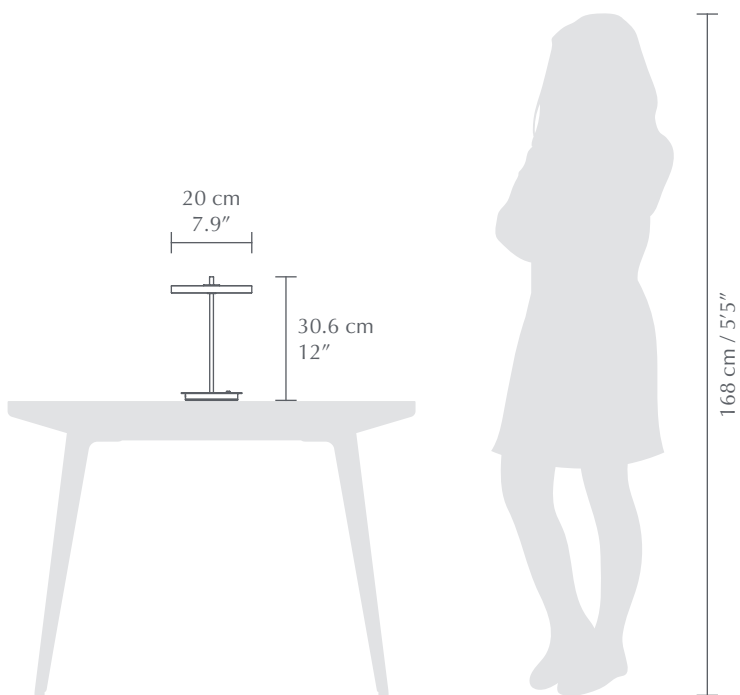
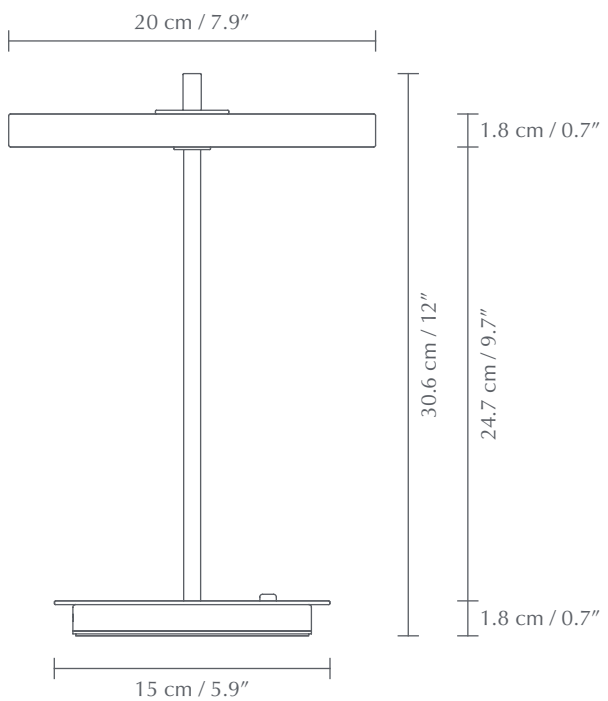

ASTERIA MOVE

Designed by Søren Ravn Christensen

PORTABLE LAMP FOR MOMENTS ON THE MOVE

Introducing Asteria Move: An UIMAGE classic with a twist. Asteria Move gives you the minimal and elegant Asteria design you already know and love, but in a smaller and cordless version, making it easy to move around, hence the name. The lamp has a Custom LED lighting built-in with a soft white diffuser that ensures a glare-free glow. Asteria Move has three levels of lighting and can be adjusted as desired. It is so simple and sleek that it's a wonder it hasn't been designed before.

Find more inspiration at page 27, 38, 41, 53, 90



Portable table lamp with built-in lithium-Ion battery



TESTS & CERTIFICATIONS

CE (for indoor use)



USB-C cable and power adaptor incl.



DIMENSIONS

Ø: 20 cm / 7.9"
H: 30.6 cm / 12"



MATERIAL

Steel, Aluminium and PMMA



WARRANTY

10 years warranty against manufacturer defects



WEIGHT INCL. PACKAGING

1.7 kg / 3.7 lb



LIGHT SOURCE

LED panel built-in
Light step 1: 3000K - 5 lm.RA: >80. 35 H
Light step 2: 3000K - 22 lm.RA: >80. 15 H
Light step 3: 3000K - 60 lm.RA: >80. 6 H



PACKAGING

Gift box dimensions (L x W x H):
24.1 x 24.1 x 9.6 cm / 9.5 x 9.5 x 3.8"



ASSEMBLY TIME

5 min - video guide at umage.com



MEDIA KIT

Photos and press material
Download at umagepress.com



ORDERING INFORMATION

Asteria Move pearl white	EU/APAC #2385 / US N/A
Asteria Move anthracite grey	EU/APAC #2386 / US N/A
Asteria Move forest green	EU/APAC #2387 / US N/A
Asteria Move ruby red	EU/APAC #2388 / US N/A
Asteria Move black	EU/APAC #2391 / US N/A

Colour variations



pearl white
(RAL: 9001)



anthracite grey
(RAL: 7016)



forest green
(RAL: 6004)



ruby red
(RAL: 3032)



black
(RAL: 9005)

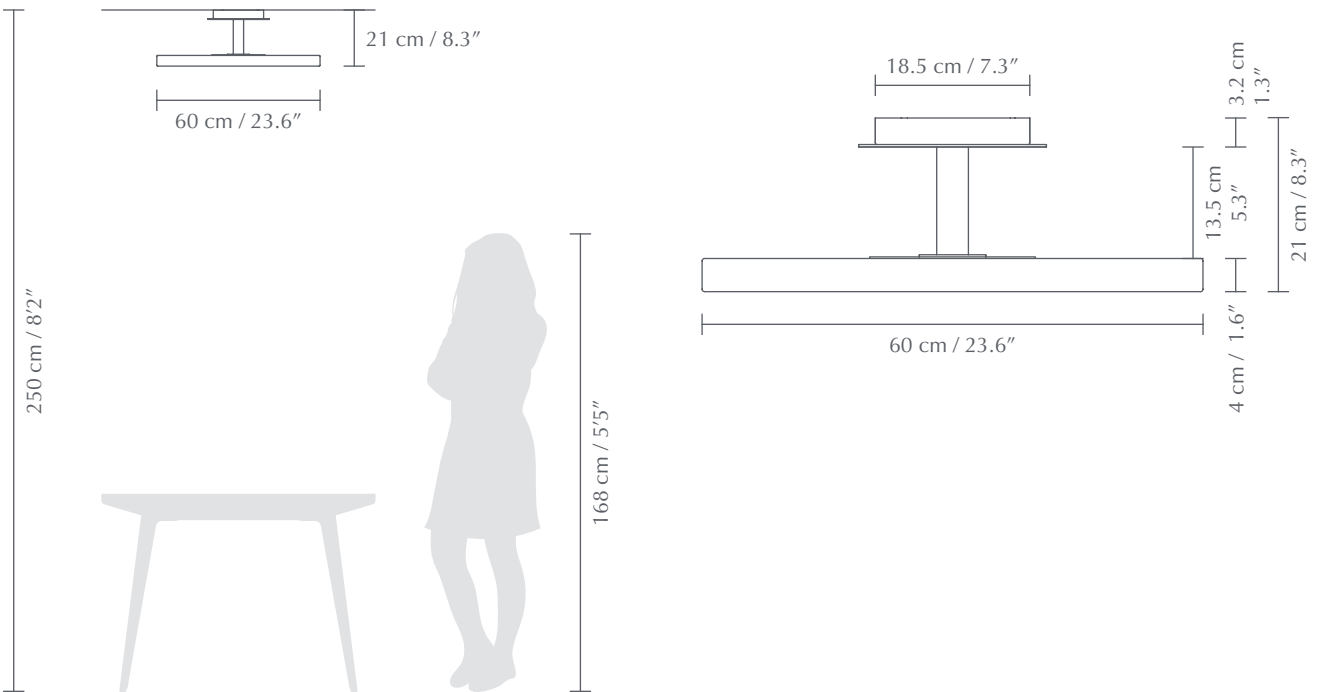

ASTERIA UP

Designed by Søren Ravn Christensen

SUBTLE YET POWERFUL

Finding the right light for the kitchen and hallways can be a challenge. The Asteria Up ceiling lamp from UIMAGE is not only offering the perfect light but is also a very discrete and stylish solution. The lampshade is placed on a brass base, adding a refined expression to the lamp design.

A top panel provides an ambient light upwards as well, enhancing the details of the design and secures a soft atmosphere in the surrounding space.

Find more inspiration at page 56, 61, 98



Surface mounted lamp



TESTS & CERTIFICATIONS

CE (for indoor use), IP2X, cETLus certified



DIMENSIONS

Ø: 60 cm / 23.6" x H: 21 cm / 8.3"



MATERIAL

Steel and PS. Metal canopy



WARRANTY

10-year warranty against manufacturer defects



WEIGHT INCL. PACKAGING

8.3 kg / 18.3 lb



LIGHT SOURCE

37W LED panel incl. ambient top light. 3000 K - 2300 lm
RA: >80. Dimmable with external dimmer*. 25000 H



PACKAGING DIMENSIONS (L x W x H)

81.8 x 62.2 x 7.7 cm



ASSEMBLY TIME

10 min - video guide at umage.com



MEDIA KIT

Photos and press material
Download at umagepress.com



ORDERING INFORMATION

Asteria Up pearl white EU/UK/APAC #2329 / US #2335
Asteria Up anthracite grey EU/UK/APAC #2330 / US #2336

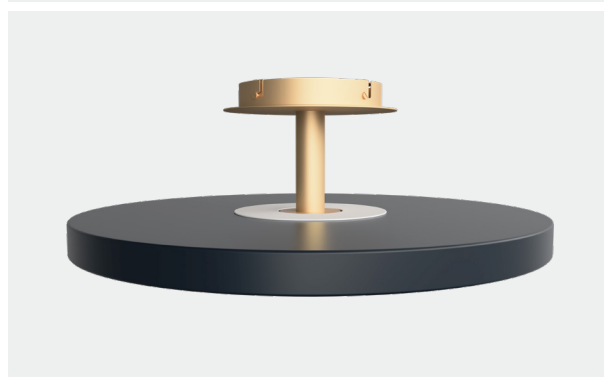
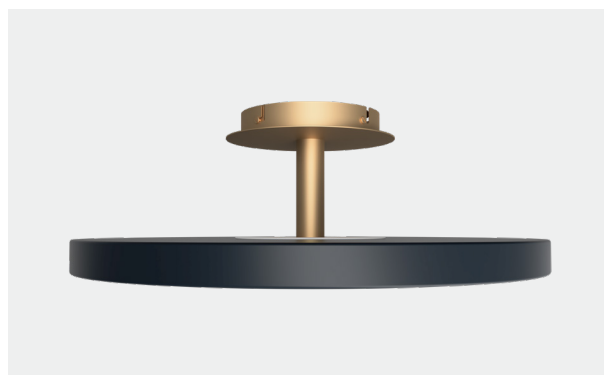

COLOUR VARIATIONS



pearl white
(RAL: 9001)



anthracite grey
(RAL: 7016)

NEW



CASSINI

Designed by Jacob Rudbeck

SCULPTURAL DETAILS

UMAGE is presenting a new lamp, Cassini™, inspired by the rings of Saturn, hence the name. The lamp has a built-in LED panel with diffusers ensuring a soft illumination in the room and securing a sustainable life of the design. A top panel provides an ambient light upwards as well as downwards, enhancing the details of the design and secures a soft atmosphere in the surrounding space.

Find more inspiration at page 52

 Pendant lamp

 **DIMENSIONS**
Mini: Ø: 20 cm / 7.8" H: 11 cm / 4.3"
Medium: Ø: 40 cm / 15.7" x H: 11 cm / 4.3"

 **MATERIAL**
Steel, Aluminium and PS. Metal canopy

 **WEIGHT INCL. PACKAGING**
3.867kg

 **LIGHT SOURCE**
LED panel built-in. 3000 K / lighting hours 25000
Dimmable with external dimmer
Mini: 14W / 320 lm, >80 ra.
Medium: 19W / 970 lm, >80 ra

 **PACKAGING DIMENSIONS (L x W x H)**
Mini: 24.8 x 21.7 x 17.3 cm / 9.7 x 8.5 x 6.8"
Medium: 42.2 x 42.2 x 13.9 cm / 16.6 x 16.6 x 5.4"

 **ASSEMBLY TIME**
10 min - video guide at umage.com

 **MEDIA KIT**
Photos and press material
Download at umagepress.com

 **ORDERING INFORMATION**
Cassini mini EU/APAC #2361 / US N/A
Cassini medium EU/APAC #2360 / US N/A

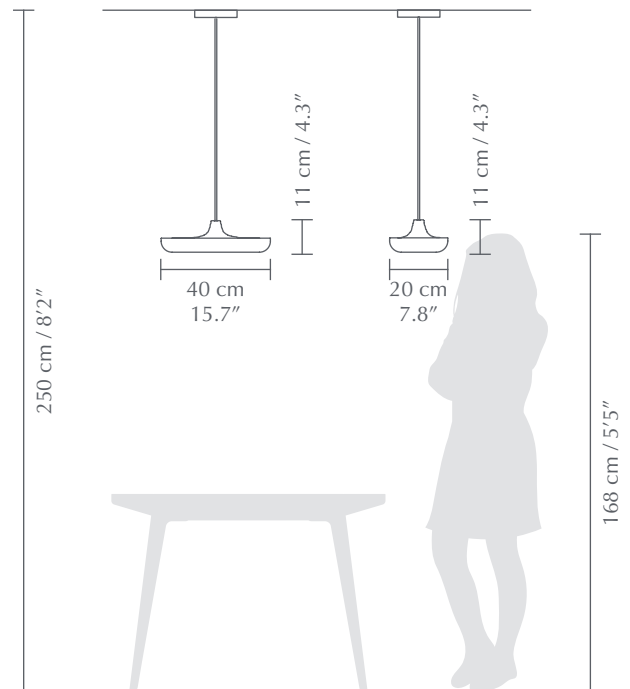

COLOUR VARIATIONS



black

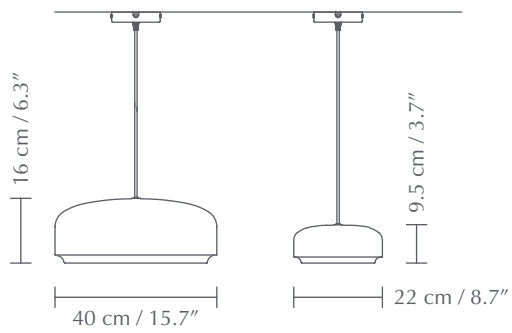

HAZEL

Designed by Jacob Rudbeck

THE FUSION OF NATURE AND TECHNOLOGY

Introducing a new lamp; Hazel™, with a shape inspired by the humble hazelnut, designed from solid materials and LED technology, it becomes a crossbreed between nature and technology. The organic shapes, the brass details, and the soft light will create a warm yet minimalistic feeling in your home.

Find more inspiration at page 73



Pendant lamp



TESTS & CERTIFICATIONS

CE (for indoor use)



DIMENSIONS

Ø: 40 cm / 15.7" Ø: 22 cm / 8.7"
H: 16 cm / 6.3" H: 9.5 cm / 3.7"



MATERIAL

Steel, Aluminium and PMMA
Incl. 2.7 m / 8'9" black textile cord and metal canopy



WARRANTY

10 years warranty against manufacturer defects



WEIGHT INCL. PACKAGING

Hazel medium: 4.9 kg / 10.8 lb
Hazel mini: 2.1 kg / 4.6 lb



LIGHT SOURCE

Hazel medium: 21W LED panel built-in
3000 K - 1100 lm. RA: >80. 25000 H
Hazel mini: 12W LED panel built-in. 3000 K - 600 lm
RA: >80. 25000 H
Dimmable with external dimmer*



PACKAGING (L x W x H)

Hazel medium: 44.7 x 44.7 x 24.4 cm / 17.6 x 17.6 x 9.6"
Hazel mini: 24.4 x 24.4 x 17.4 cm / 9.6 x 9.6 x 6.9"



ASSEMBLY TIME

10 min - video guide at umage.com



MEDIA KIT

Photos and press material
Download at umagepress.com



ORDERING INFORMATION

Hazel medium EU/APAC #2440 / US N/A
Hazel mini EU/APAC #2441 / US N/A

Colour variations

* For recommended external dimmers, go to umagepress.com



black
(RAL: 9005)

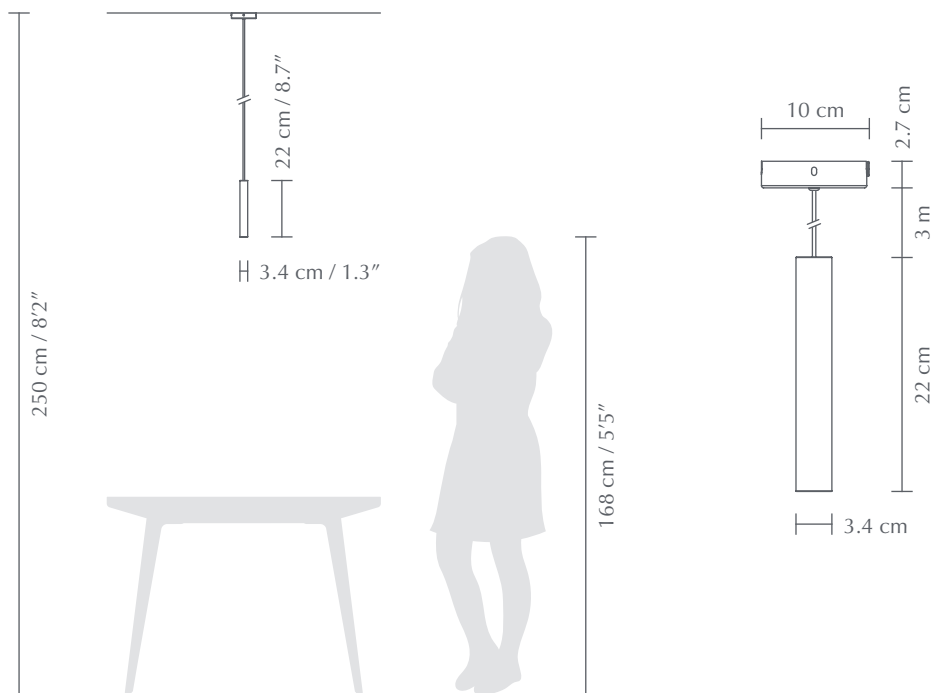

CHIMES

Designed by Asger Risborg Jacobsen

PUT NATURE IN SPOTLIGHT

A simple piece of solid oak infused with a warm LED spotlight brings the Nordic tones of nature into the interior. Chimes™ is inspired by the graceful lines that occur in a dense forest of trees growing closely together. Designed with the thinnest possible shape in mind, the lamp has a spotlight effect that shines light exactly where you need it.

Create new areas and cosy spaces with focused light by using one, two or even clusters and lines of Chimes™. An effortlessly charming and understated lamp, Chimes™ is bringing a focused lighting on kitchen counters and worktables. The lamp's spot also makes a good reading light beside a chair or over a dining table and has a cosy candlelight quality for relaxed evenings in the company of friends. Create special areas in bars, restaurants and hotel lobbies with Chimes™' beautiful wooden surface.

Find more inspiration at page 69



Pendant lamp



TESTS & CERTIFICATIONS

CE (for indoor use), IP2X



DIMENSIONS

Ø: 3.4 cm / 1.3"
H: 22 cm / 8.7"



MATERIAL

Solid oak and Polypropylene
Incl. 3 m / 118" black cord and metal canopy



WARRANTY

10 years warranty against manufacturer defects



WEIGHT INCL. PACKAGING

600 g / 1.3 lb



LIGHT SOURCE

2W LED spot built-in. 3000 K - 220 lm. RA: ≥80
Non-Dimmable. 50000 H



PACKAGING DIMENSIONS (L x W x H)

17.4 x 25.7 x 4.3 cm / 6.9 x 10.1 x 1.7"



ASSEMBLY TIME

2 min - video guide at umage.com



MEDIA KIT

Photos and press material
Download at umagepress.com



ORDERING INFORMATION

Chimes oak	EU/UK/APAC #2165 / US N/A
Chimes dark oak	EU/UK/APAC #2167 / US N/A
Chimes black oak	EU/UK/APAC #2265 / US N/A

COLOUR VARIATIONS



oak



dark oak



black

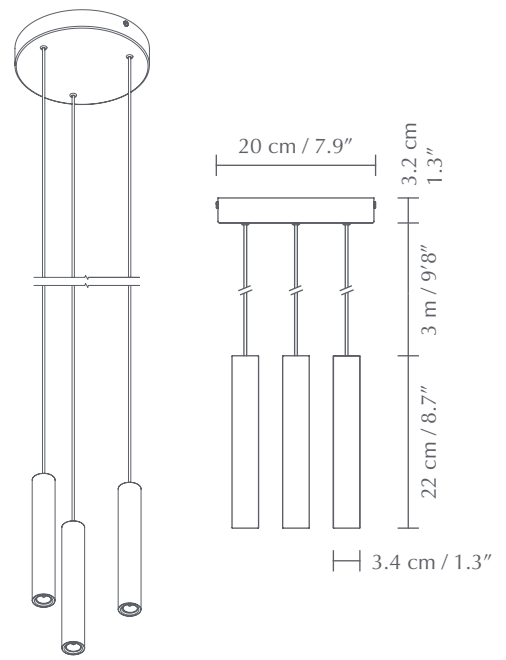
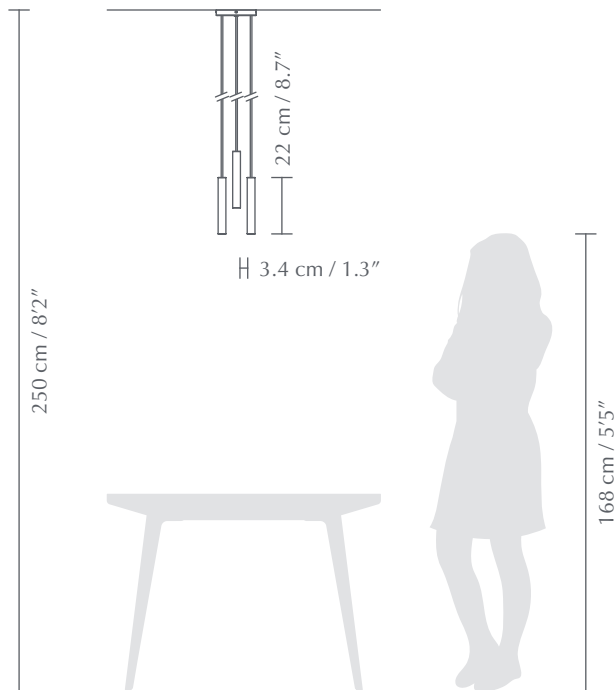

CHIMES CLUSTER 3

Designed by Asger Risborg Jacobsen

PUT NATURE IN SPOTLIGHT WITH THE CHIMES™ CLUSTER 3

A simple piece of solid oak infused with a warm LED spotlight brings the Nordic tones of nature into the interior. Chimes™ cluster 3 is inspired by the graceful lines that occur in a dense forest of trees growing closely together. Designed with the thinnest possible shape in mind, the lamp has a spotlight effect that shines light exactly where you need it.

Create new areas and cosy spaces with focused light by using Chimes™ cluster 3. An effortlessly charming and understated lamp, Chimes™ cluster 3 is bringing a focused lighting on dining table. The lamp's spot also makes a good reading light beside a chair and has a cosy candlelight quality for relaxed evenings in the company of friends.

Create special areas in bars, restaurants and hotel lobbies with Chimes™ cluster 3's beautiful wooden surface.

Find more inspiration at page 57



Pendant lamp



TESTS & CERTIFICATIONS

CE (for indoor use), IP2X



DIMENSIONS

Ø: 3.4 cm / 1.3" x H: 22 cm / 8.7"



MATERIAL

Solid Oak
Incl. 3 m / 118" black textile cord and metal canopy



WARRANTY

10 years warranty against manufacturer defects



LIGHT SOURCE

3x 2W LED spot built-in. 3000 K - 220 lm. RA: ≥80
Non-Dimmable. 50000 H



PACKAGING DIMENSIONS (L x W x H)

23.8 x 40.5 x 4.5 cm / 9.4 x 16 x 1.8"



ASSEMBLY TIME

2 min - video guide at umage.com



MEDIA KIT

Photos and press material
Download at umagepress.com



ORDERING INFORMATION

Chimes cluster 3 oak EU/UK/APAC #2230 / US N/A
Chimes cluster 3 dark oak EU/UK/APAC #2231 / US N/A
Chimes cluster 3 black oak EU/UK/APAC #2232 / US N/A

COLOUR VARIATIONS



oak



dark oak



black oak

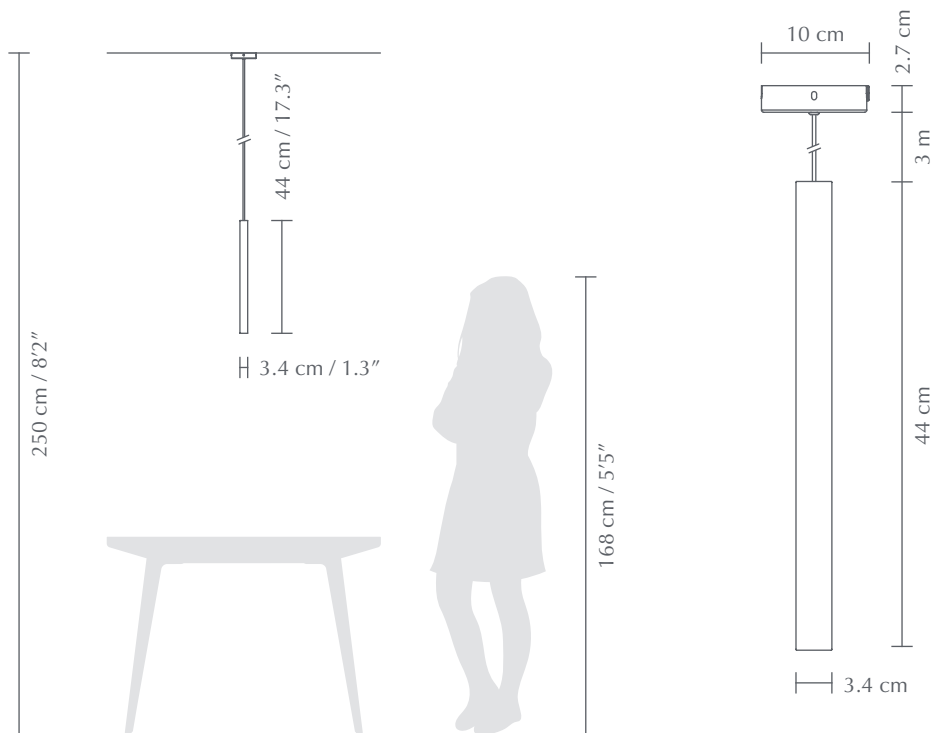

CHIMES TALL

Designed by Asger Risborg Jacobsen

VERTICAL WOODEN LINES THAT INSTANTLY CONNECTS THE CEILING TO THE REST OF THE ROOM

The simple piece of solid oak infused with warm LED spotlight brings the Nordic tones of nature into the interior and secures a focused light. The Chimes™ tall is inspired by the graceful lines that occur in a dense forest of trees growing closely together.

The lamps spotlight offers a great light above kitchen counters, in the dining table, but would also fit perfectly into hotel lobbies, restaurants and bars. Chimes™ is designed by the acknowledged designer and architect, Asger Risborg Jacobsen, known for his 'Stedsans in the woods' project in the Swedish forest.

Find more inspiration at page 81



Pendant lamp



TESTS & CERTIFICATIONS

CE (for indoor use), IP2X



DIMENSIONS

Ø: 3.4 cm / 1.3" x H: 44 cm / 17.3"



MATERIAL

Solid Oak
Incl. 3 m / 118" black textile cord and metal canopy



WARRANTY

10 years warranty against manufacturer defects



LIGHT SOURCE

2W LED spot built-in. 3000 K - 220 lm. RA: ≥80
Non-Dimmable. 50000 H



PACKAGING DIMENSIONS (L x W x H)

11.8 x 55.8 x 4.2 cm / 4.6 x 22 x 1.7"



ASSEMBLY TIME

2 min - video guide at umage.com



MEDIA KIT

Photos and press material
Download at umagepress.com



ORDERING INFORMATION

Chimes tall oak EU/UK/APAC #2233 / US N/A
Chimes tall dark oak EU/UK/APAC #2234 / US N/A
Chimes tall black oak EU/UK/APAC #2235 / US N/A

COLOUR VARIATIONS



oak



dark oak



black oak



EOS EVIA

Designed by Søren Ravn Christensen

SHAPES FROM THE NATURE

Resembling the shape of nature's beehive, Eos Evia is a magnetic design piece with an irresistible tactility. The Eos Evia lampshade will be the centre of attention hanging as a chandelier in the living room or hallway. The name Eos originates from Greek mythology, the goddess of the dawn, referencing how the lampshade looks like clouds in the sky and the two new shapes are no different. named after the two daughters of the designer. The shapes Evia and Esther are opening new expressions and possibilities together with the existing Eos collection.

Find more inspiration at page 49, 82



Pendant, floor and table lampshade
Compatible with E26 / E27



Flip 180°



Easily cleaned with hairdryer



DIMENSIONS

Medium: Ø 40 cm / 16" H 39 cm / 15.3"
Large: Ø 55 cm / 21.6" H 54 cm / 21.2"



MATERIAL

Goose feathers, fabric and white powder coated steel



FEATHERS

Medium: 2340 feathers
Large: 4500 feathers



FIRE RETARDANT

For fire retardant version, order US item numbers



LIGHT SOURCE

E26 / E27 - max 15W LED (not included)



GIFT BOX PACKAGING (L x W x H):

Medium: 39.4 x 39.4 x 10.5 cm / 15.5 x 15.5 x 4"
Large: 54.4 x 54.4 x 12.5 cm / 21.4 x 21.4 x 5"



ASSEMBLY TIME

5 min - video guide at umage.com



MEDIA KIT

Photos and press material
Download at umagepress.com



ORDERING INFORMATION

Eos Evia medium EU/UK #2349 / US/APAC #3026
Eos Evia large EU/UK #2350 / US/APAC #3027

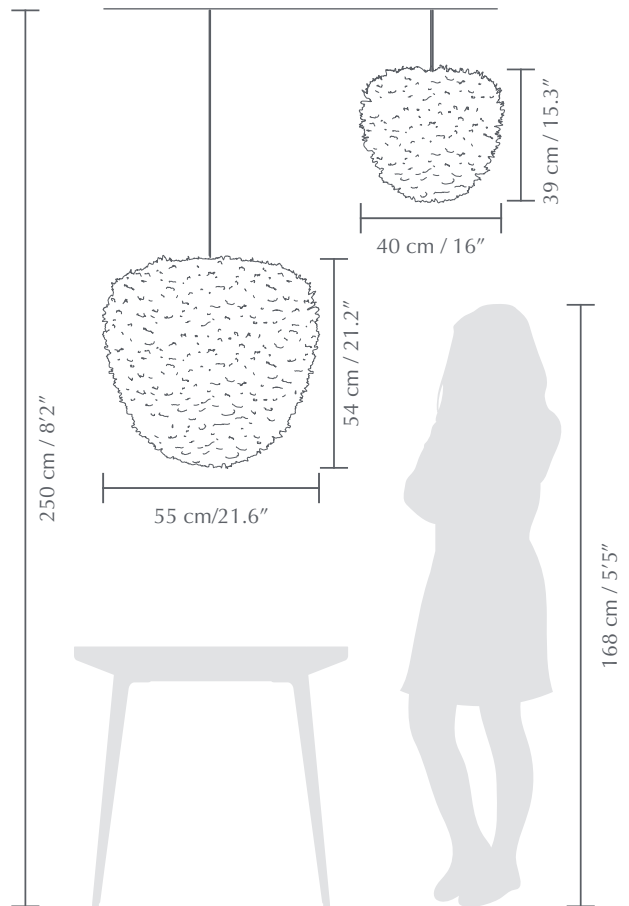

COLOUR VARIATIONS



white

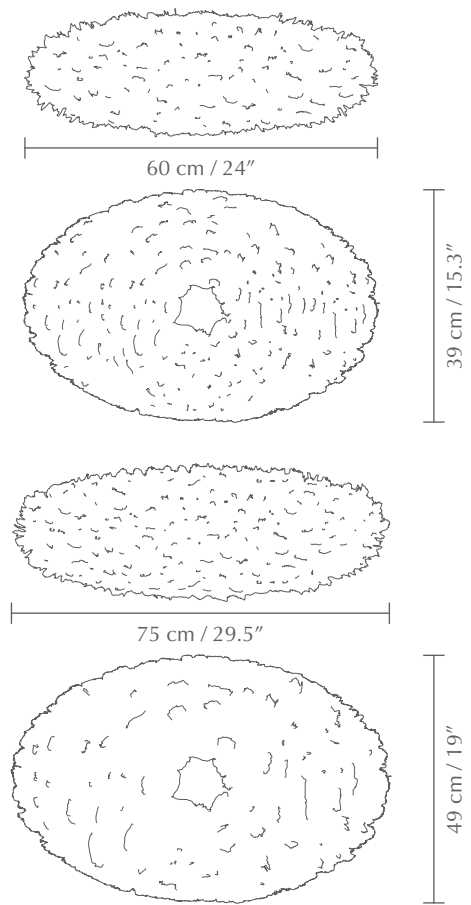
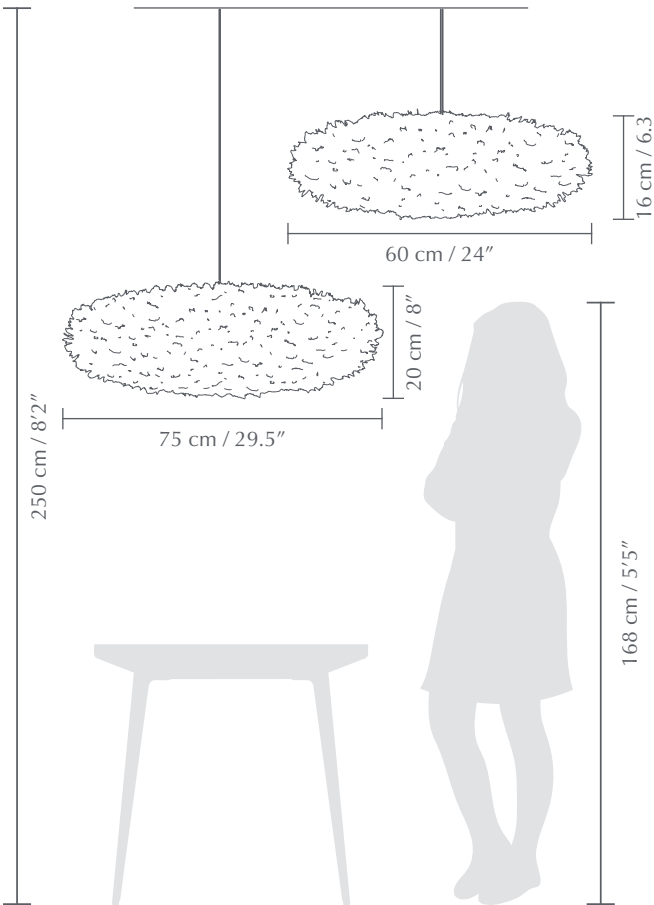

EOS ESTHER

Designed by Søren Ravn Christensen

SHAPES FROM THE NATURE

Eos Esther is an elegant and slim cloud hanging from the ceiling, that can be rotated and hung from four different angles, extending the flexibility and visual effect of the lampshade. The oval shape of Eos Esther makes it an elegant solution for the dining table.

The name Eos originates from Greek mythology, the goddess of the dawn, referencing how the lampshade looks like clouds in the sky and the two new shapes are no different. Named after the two daughters of the designer. The shapes Evia and Esther are opening new expressions and possibilities together with the existing Eos collection.

Find more inspiration at page 47, 100



Pendant and floor lampshade
Compatible with E26 / E27



Tilt-adjustable wire construction: 4 angles



Easily cleaned with hairdryer



DIMENSIONS (H x W x D)

Medium: 16 cm / 6.3", 60 cm / 24", 39 cm / 15.3"
Large: 20 cm / 8", 75 cm / 29.5", 49 cm / 19"



MATERIAL

Goose feathers, fabric and white powder coated steel



FEATHERS

Medium: 2790 feathers
Large: 4860 feathers



FIRE RETARDANT

For fire retardant version, order US item numbers



LIGHT SOURCE

E26 / E27 - max 15W LED (not included)



GIFTBOX PACKAGING (L x W x H):

Medium: 62.6 x 46.8 x 7.3 cm / 25 x 18.4 x 3"
Large: 77.6 x 56.6 x 8.3 cm / 30.5 x 22.3 x 3.3"



ASSEMBLY TIME

5-7 min - video guide at umage.com



MEDIA KIT

Photos and press material
Download at umagepress.com



ORDERING INFORMATION

Eos Esther medium white EU/UK #2347 / US/APAC #3024
Eos Esther large white EU/UK #2348 / US/APAC #3025



COLOUR VARIATIONS



white



EOS UP

Designed by Søren Ravn Christensen

ADD A STATEMENT TO THE SPACE

The Eos Up is the perfect companion for small spaces in need of big designs. Eos Up gives a soft, warm light that adds a sophisticated and elegant touch to any interior decor. Its clever construction makes it easy to mount directly onto the ceiling or wall.

Find more inspiration at page 83, 99

 Surface mounted lamp
Comes with 2 x E26 / E27

 **TESTS & CERTIFICATIONS**
CE (for indoor use)
Medium/large: IP2X, cULus certified

 Easily cleaned with hairdryer

 **DIMENSIONS**
Mini: Ø: 30 cm / 11.8" H: 14 cm / 5.5"
Medium: Ø: 40 cm / 15.7" H: 15 cm / 5.9"
Large: Ø: 70 cm / 27.6" H: 27 cm / 10.6"

 **MATERIAL**
Goose feathers, Fabric and Steel

 **FEATHERS**
Mini: 750 feathers
Medium: 1175 feathers
Large: 2475 feathers

 **FIRE RETARDANT**
For fire retardant version, order US item numbers

 **WEIGHT INCL. PACKAGING**
Mini: 0.69 kg / 1.5 lb
Medium: 1.3 kg / 2.8 lb
Large: 2.6 kg / 5.7 lb

 **LIGHT SOURCE**
Mini: 2 x E14 - max 15W LED (not included)
2 x E26 / E27 - max 15W LED (not included)

 **PACKAGING DIMENSIONS (L x W x H)**
Mini: 28,8 x 28,8 x 11,3 cm / 11,3 x 11,3 x 4,4"
Medium: 38.6 x 38.6 x 14.5 cm / 15.2 x 15.2 x 5.7"
Large: 68.5 x 68.5 x 15 cm / 10.6 x 10.6 x 5.9"

 **ASSEMBLY TIME**
15 min - video guide at umage.com

 **MEDIA KIT**
Photos and press material
Download at umagepress.com

 **ORDERING INFORMATION**
Eos Up medium EU/UK #2140 / US/APAC #2150
Eos Up large EU/UK #2141 / US/APAC #3016
Eos Up mini EU/UK #2142 / US/APAC #2143

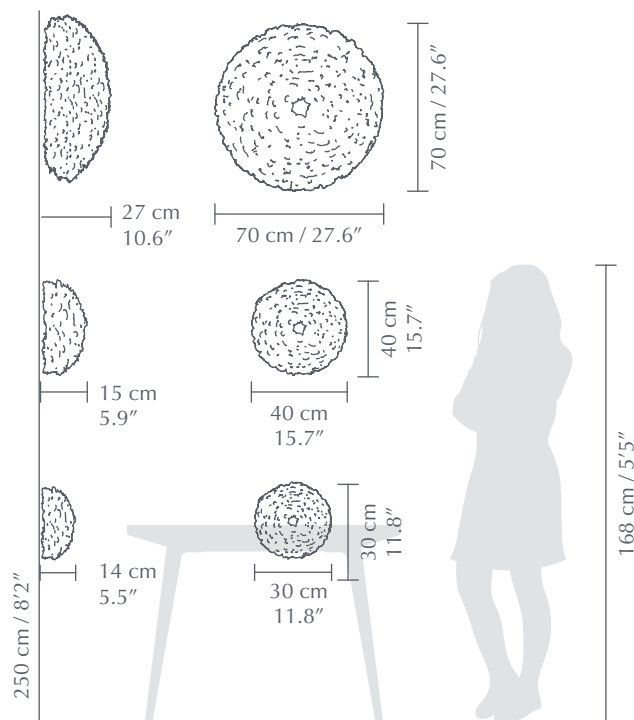
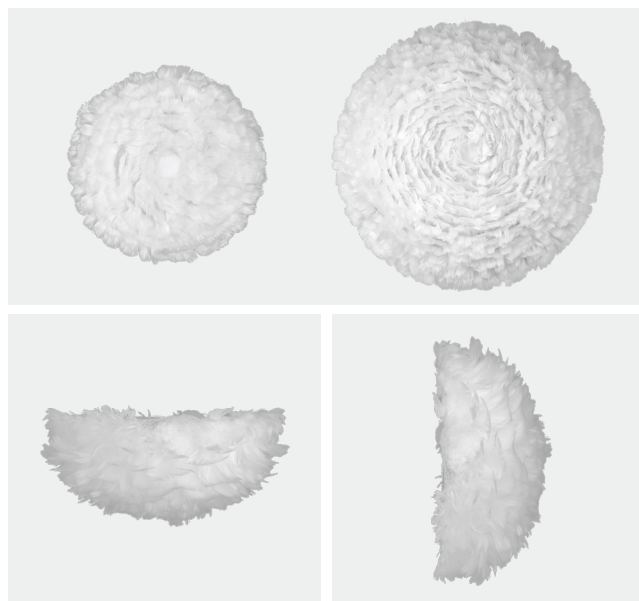

COLOUR VARIATIONS



white

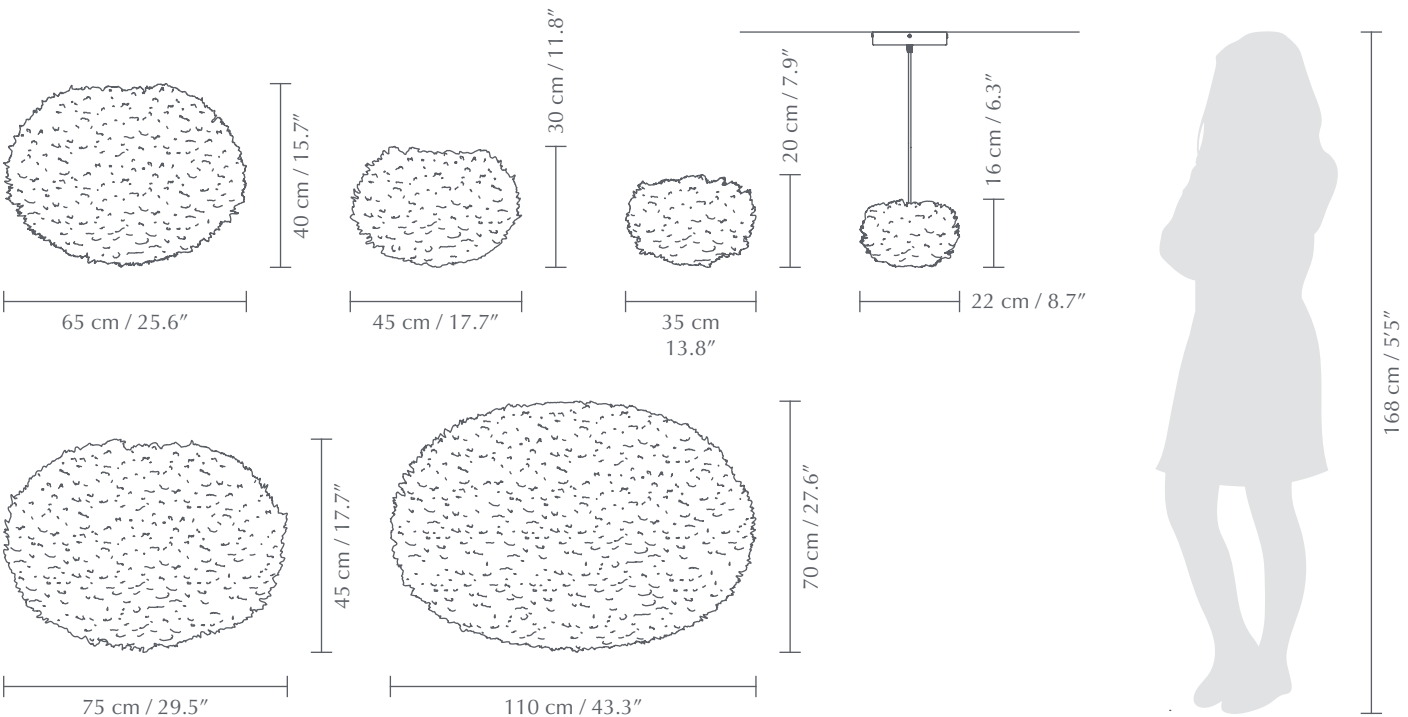

EOS

Designed by Søren Ravn Christensen

SOFT ELEGANCE FROM NATURE

The Eos lampshade draws its force and beauty from the earth tones of the Nordic landscape. A natural colour palette that creates a warm and welcoming atmosphere – this is the quintessence of the Eos family! With a neutral and harmonious colour, the Eos lampshade will perfectly suit any minimalist interior design, adding a sophisticated and elegant touch. Either in a modern living room or in a classic bedroom, this lampshade will bring a trendy yet timeless look and a soothing vibe to your space.

“The Eos blends with the room and brings out the best in it. It fits perfectly in a light environment without many impressions, with, for example, only earth colours or dark wooden tones”, explains Søren Ravn Christensen, Founder and Chief Creative Developer.

Find more inspiration at page 16, 17, 18, 22, 23, 25, 29, 45, 48, 49, 64, 65, 80, 83, 85, 94, 104



ORDERING INFORMATION

Eos micro white	EU/UK #2091 / US/APAC #3000
Eos micro light grey	EU/UK #2123 / US/APAC #3012
Eos micro light brown	EU/UK #2125 / US/APAC #3014
Eos mini white	EU/UK #2011 / US/APAC #3001
Eos mini light grey	EU/UK #2124 / US/APAC #3013
Eos mini light brown	EU/UK #2126 / US/APAC #3015
Eos mini red	EU/UK #2022 / US/APAC #3029
Eos mini light blue	EU/UK #2046 / US/APAC #3032
Eos mini light rose	EU/UK #2298 / US/APAC N/A
Eos medium white	EU/UK #2010 / US/APAC #3002
Eos medium light brown	EU/UK #2066 / US/APAC #3006
Eos medium light grey	EU/UK #2085 / US/APAC #3009
Eos medium red	EU/UK #2021 / US/APAC #3030
Eos medium light blue	EU/UK #2024 / US/APAC #3033
Eos medium light rose	EU/UK #2300 / US/APAC N/A
Eos large white	EU/UK #2042 / US/APAC #3003
Eos large light brown	EU/UK #2089 / US/APAC #3007
Eos large light grey	EU/UK #2090 / US/APAC #3010
Eos large red	EU/UK #2023 / US/APAC #3031
Eos large light blue	EU/UK #2047 / US/APAC #3034
Eos large light rose	EU/UK #2299 / US/APAC N/A
Eos x-large white	EU/UK #2012 / US/APAC #3004
Eos x-large light brown	EU/UK #2067 / US/APAC #3008
Eos x-large light grey	EU/UK #2086 / US/APAC #3011
Eos xx-large white	EU/UK #2041 / US/APAC #3005

Colour variations



white



light brown



light grey



red



light blue



light rose



Pendant, floor and table lampshade
Compatible with E26 / E27



Flip 180°



Easily cleaned with hairdryer



Fading can be caused by sun exposure



Fire resistant (for US products)



DIMENSIONS

Eos micro (Ø × H): 22 x 16 cm / 8.7 x 6.3"
Eos mini (Ø × H): 35 x 20 cm / 12.6 x 7.9"
Eos medium (Ø × H): 45 x 30 cm / 17.7 x 11.8"
Eos large (Ø × H): 65 x 40 cm / 25.6 x 15.7"
Eos x-large (Ø × H): 75 x 45 cm / 29.5 x 17.7"
Eos xx-large (Ø × H): 110 x 70 cm / 43.3 x 27.6"



MATERIAL

Eos micro: App. 500 goose feathers, paper and steel
Eos mini: App. 900 goose feathers, paper and steel
Eos medium: App. 1800 goose feathers, paper and steel
Eos large: App. 4050 goose feathers, paper and steel
Eos x-large: App. 5400 goose feathers, paper and steel
Eos xx-large: App. 12150 goose feathers, paper and steel



WEIGHT INCL. PACKAGING

Eos micro: 330 g / 0.7 lb
Eos mini: 500 g / 1.1 lb
Eos medium: 1 kg / 2.2 lb
Eos large: 1.6 kg / 3.5 lb
Eos x-large: 2.9 kg / 6.4 lb
Eos xx-large: 6.4 kg / 14.1 lb



LIGHT SOURCE

E26 / E27 - max 15W LED (not included)



PACKAGING (L x W x H)

Eos micro: 21.7 x 21.7 x 7 cm / 8.5 x 8.5 x 2.8"
Eos mini: 29.5 x 29.5 x 7 cm / 11.6 x 11.6 x 2.8"
Eos medium: 39.4 x 39.4 x 7 cm / 15.5 x 15.5 x 2.8"
Eos large: 60.5 x 60.5 x 8 cm / 23.8 x 23.8 x 3.1"
Eos x-large: 78 x 78 x 8 cm / 30.7 x 30.7 x 3.1"
Eos xx-large: 116 x 116 x 7 cm / 45.7 x 45.7 x 2.8"



ASSEMBLY TIME

5 min - video guide at umage.com



MEDIA KIT

Photos and press material
Download at umagepress.com



JAZZ

Designed by Magnus Nero & Ingemar Jönsson

ORGANIC SHADE OF THE NORDIC NATURE

Nothing makes you feel closer to the nature than the scent of wood, reminding us to slow down our lives and breathe, even if it's just for a moment. Made from oak the lampshade will bring the Nordic tones of nature into the interior. Crafted from an exclusive 3D veneer technology with an organic shape that will add warmth and vitality to the home.

The lampshade is inspired by the flowing lines found in a flourishing frangipani flower and a classical gramophone horn, hence the name. Jazz is designed by the design duo Magnus Nero and Ingemar Jönsson, with an international design profile working for Tom Dixon and Artek in the past. Use it as a pendant above the dining table, on Champagne floor, on the Willow family or simply placed directly on the floor creating a strong statement in the interior.

Find more inspiration at page 95

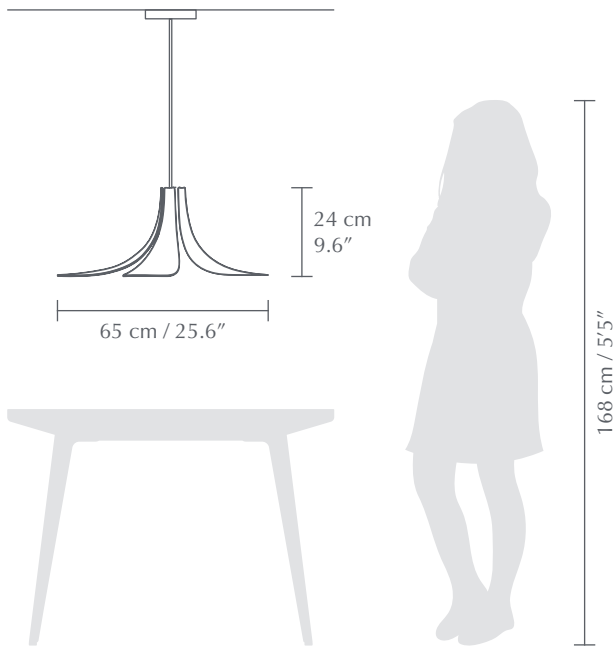

Colour variations



oak



dark oak



black oak



Pendant, floor and table lampshade
Compatible with E26 / E27



Flip 180°



DIMENSIONS
Ø: 65 cm / 25.6"
H: 24 cm / 9.4"



MATERIAL
Oak 3D veneer



WEIGHT INCL. PACKAGING
1.7 kg / 3.7 lb



LIGHT SOURCE
E26 / E27 - max 15W LED (not included)



PACKAGING
Gift box dimensions (L x W x H):
19.6 x 49.3 x 17.6 cm / 7.7 x 19.4 x 6.9"



ASSEMBLY TIME
15 min - video guide at umage.com



MEDIA KIT
Photos and press material
Download at umagepress.com



ORDERING INFORMATION
Jazz oak EU/UK/US/APAC #2216
Jazz dark oak EU/UK/US/APAC #2218
Jazz black oak EU/UK/US/APAC #2223



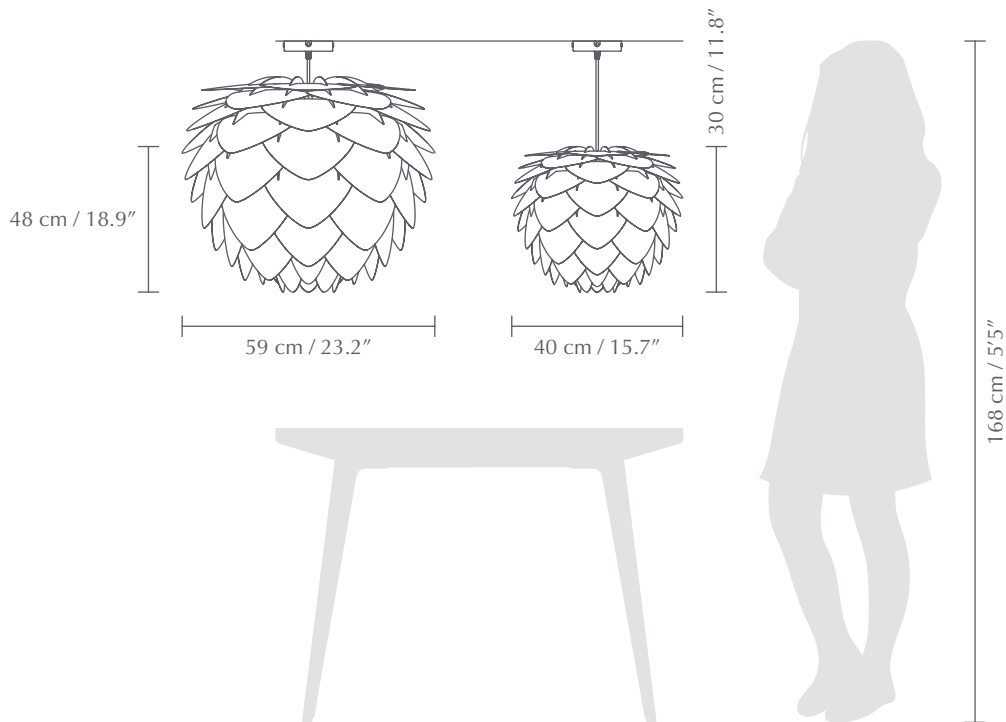

ALUVIA

Designed by UIMAGE Design Team

EXPLORE LIFE AND NATURE WITH ALUVIA

With characteristic geometrical blades made from aluminium, the Aluvia lamp has a distinctive edge, while being lightweight and durable at the same time. Aluvia amplifies the beauty of your interior design, making your home cosy, classic and refined, while also bringing a touch of nature inside through its organic shape.

Søren Ravn Christensen, Founder and Chief Creative Developer says: *"Imagine if flowers could light up. They would create the most playful dancing shadows, spinning around and making everything come to life! Aluvia embodies just that – nature's magic in your home."*

Start your journey from the depths of the oceans, to the bustling city, passing through the enchanting forests, all in one eclectic product

Find more inspiration at page 12, 13, 39, 44, 46, 72

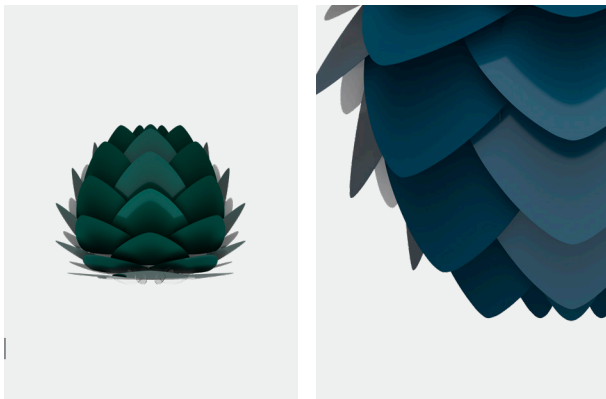

 Pendant, floor and table lampshade
Compatible with E26 / E27

 Flip 180°

 Durable

DIMENSIONS
 Ø: 59 cm / 23.2" Ø: 40 cm / 15.7"
 H: 48 cm / 18.9" H: 30 cm / 11.8"

MATERIAL
 Aluminium, Polypropylene and Polycarbonate

WEIGHT INCL. PACKAGING
 Aluvia medium: 2 kg / 4.4 lb
 Aluvia mini: 850 g / 1.9 lb

LIGHT SOURCE
 E26 / E27 - max 15W LED (not included)

PACKAGING (L x W x H)
 Aluvia medium: 29.7 x 41 x 4.3 cm / 11.7 x 16.1 x 1.7"
 Aluvia mini: 19.7 x 26.7 x 4.3 cm / 7.8 x 10.5 x 1.7"

ASSEMBLY TIME
 20 min - video guide at umage.com

MEDIA KIT
 Photos and press material
 Download at umagepress.com

ORDERING INFORMATION

Aluvia medium brushed brass	EU/UK/US/APAC #2121
Aluvia medium pearl white	EU/UK/US/APAC #2127
Aluvia medium anthracite grey	EU/UK/US/APAC #2129
Aluvia medium forest green	EU/UK/US/APAC #2131
Aluvia medium petrol blue	EU/UK/US/APAC #2133
Aluvia medium ruby red	EU/UK/US/APAC #2135
Aluvia medium saffron yellow	EU/UK/US/APAC #2137
Aluvia medium brushed bronze	EU/UK/US/APAC #2146
Aluvia mini brushed brass	EU/UK/US/APAC #2122
Aluvia mini pearl white	EU/UK/US/APAC #2128
Aluvia mini anthracite grey	EU/UK/US/APAC #2130
Aluvia mini forest green	EU/UK/US/APAC #2132
Aluvia mini petrol blue	EU/UK/US/APAC #2134
Aluvia mini ruby red	EU/UK/US/APAC #2136
Aluvia mini saffron yellow	EU/UK/US/APAC #2138
Aluvia mini brushed bronze	EU/UK/US/APAC #2147

Colour variations



brushed
brass



pearl white
(RAL: 9001)



anthracite grey
(RAL: 7016)



forest green
(RAL: 6004)



petrol blue
(RAL: 3025)



ruby red
(RAL: 3032)



saffron yellow
(RAL: 1004)



brushed
bronze



ACORN

Designed by Jacob Rudbeck

TAKE A WALK THROUGH THE PEACEFUL FORESTS

How many times have you walked through a peaceful forest, breathed in the fresh crisp air and listened to the sound of the wind playing with the leaves, thinking that this is a memory you want to keep? UIMAGE aims to make sure that its customers can keep this picturesque image close to their hearts and into their homes with the Acorn family of lampshades.

Inspired by the humble acorn, the pendant light offers a warm glow, perfect for living rooms or kitchens, bathrooms and bedrooms. The Acorn's visible decorative bulb emits a calming light through the glass lampshades. Whether you prefer an industrial look or something more classic, the Acorn looks delightful in cluster above a breakfast bar or dining table, or solitarily lighting a cosy corner.

Find more inspiration at page 10, 43, 71, 93

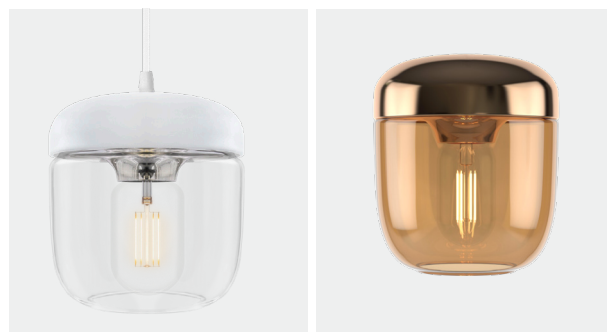

 Pendant lampshade
Compatible with E26 / E27

 **DIMENSIONS**
Ø: 14 cm / 5.5" x H: 16 cm / 6.3"

 **MATERIAL**
Glass, Silicone and Aluminium

 **WEIGHT INCL. PACKAGING**
690 g / 1.5 lb

 **LIGHT SOURCE**
E26 / E27 - max 15W LED (not included)

 **PACKAGING DIMENSIONS (L x W x H)**
17.5 x 17.5 x 17.5 cm / 6.9 x 6.9 x 6.9"

 **ASSEMBLY TIME**
5 min - video guide at umage.com

 **MEDIA KIT**
Photos and press material
Download at umagepress.com

 **ORDERING INFORMATION**

Acorn black polished steel	EU/UK/US/APAC #2081
Acorn black polished brass	EU/UK/US/APAC #2082
Acorn black polished copper	EU/UK/US/APAC #2083
Acorn white polished steel	EU/UK/US/APAC #2104
Acorn white polished brass	EU/UK/US/APAC #2105
Acorn white polished copper	EU/UK/US/APAC #2106
Acorn smoked steel	EU/UK/US/APAC #2214
Acorn amber brass	EU/UK/US/APAC #2215

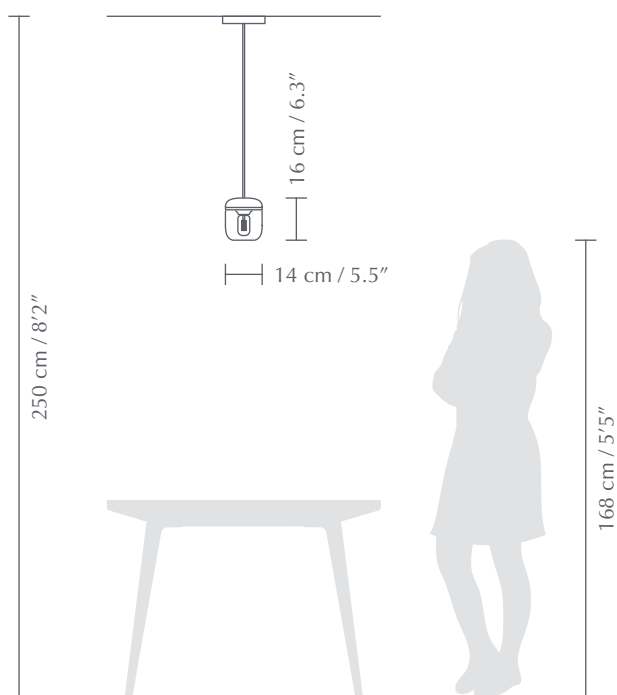

COLOUR VARIATIONS



black
polished steel



black
polished brass



black
polished copper



white
polished steel



white
polished brass



white
polished copper



smoked steel



amber brass

NEW



CLAVA UP WOOD

Designed by Søren Ravn Christensen

SPRUCE UP THE WALLS WITH RAYS OF LIGHT

UMAGE is extending the sculptural Clava™ collection with a new variant for the wall, called Clava Up™ wood. The recognizable shape made from laser-cut wood lamellae is designed to illuminate home with a playful flash of light on the walls in the surrounding space.

Clava Up™ wood is available in oak, dark oak and black oak in two different sizes.

The wall lamp will become the perfect add-on to a beautiful gallery wall or hanging side by side in a long hallway.

Find more inspiration at page 27

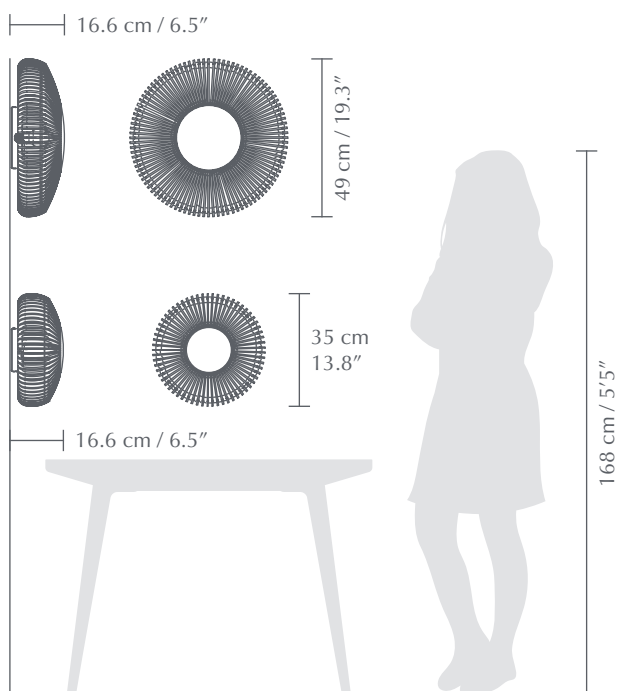

Colour variations



oak



dark oak



black oak



Wall and ceiling lamp
Compatible with E26 / E27



TESTS & CERTIFICATIONS

CE (for indoor use)



DIMENSIONS

Ø: 49 cm / 19.3" Ø: 35 cm / 13.8"
H: 16.6 cm / 6.5" H: 16.6 cm / 6.5"



MATERIAL

Oak, Ash and Laminated veneer



WEIGHT INCL. PACKAGING

Clava Up Wood large: 4.1 kg / 9 lb
Clava Up Wood medium: 2.4 kg / 5.3 lb



LIGHT SOURCE

E26 / E27 - max 15W LED G40 (not included)



PACKAGING (L x W x H)

Large: 53.4 x 53.4 x 19 cm / 21 x 21 x 7.5"
Medium: 40.4 x 40.4 x 18.8 cm / 15.9 x 15.9 x 7.4"



ASSEMBLY TIME

5 min - video guide at umage.com



MEDIA KIT

Photos and press material
Download at umagepress.com



ORDERING INFORMATION

Large oak ash	EU/UK/APAC #2358 / US N/A
Large dark oak ash	EU/UK/APAC #2359 / US N/A
Large black oak ash	EU/UK/APAC #2369 / US N/A
Medium oak ash	EU/UK/APAC #2381 / US N/A
Medium dark oak ash	EU/UK/APAC #2382 / US N/A
Medium black oak ash	EU/UK/APAC #2383 / US N/A





CLAVA DINE WOOD

Designed by Søren Ravn Christensen

UNIQUE PRECISION AND ACCURACY

The Clava Dine™ Wood lampshade is designed from a craftsmanship technique that requires a unique precision and accuracy due to the small distance between each lamella. The wooden lamellae are made from laser cut ash and oak veneer with a solid oak top.

The lampshade stands out as a sculptural design piece that creates a playful flash of light on the walls in the surrounding space.

The fidelity of the lamellae creates a beautiful pattern that can be admired from all angles, on the inside as well as on the outside the lampshade

Find more inspiration at page 14, 68



Pendant lampshade
Compatible with E26 / E27



DIMENSIONS
Ø: 43 cm / 17" x H: 24 cm / 9.4"



MATERIAL
Oak, ash, laminated veneer



WEIGHT INCL. PACKAGING
3.4 kg



LIGHT SOURCE
E26 / E27 - max 15W LED (not included)



PACKAGING DIMENSIONS (L x W x H)
45.8 x 45.8 x 16 cm / 18 x 18 x 6.3"



ASSEMBLY TIME
5 min - video guide at umage.com



MEDIA KIT
Photos and press material
Download at umagepress.com



ORDERING INFORMATION
Clava Dine Wood oak ash EU/UK/US/APAC #2343
Clava Dine Wood dark oak ash EU/UK/US/APAC #2344
Clava Dine Wood black oak ash EU/UK/US/APAC #2362

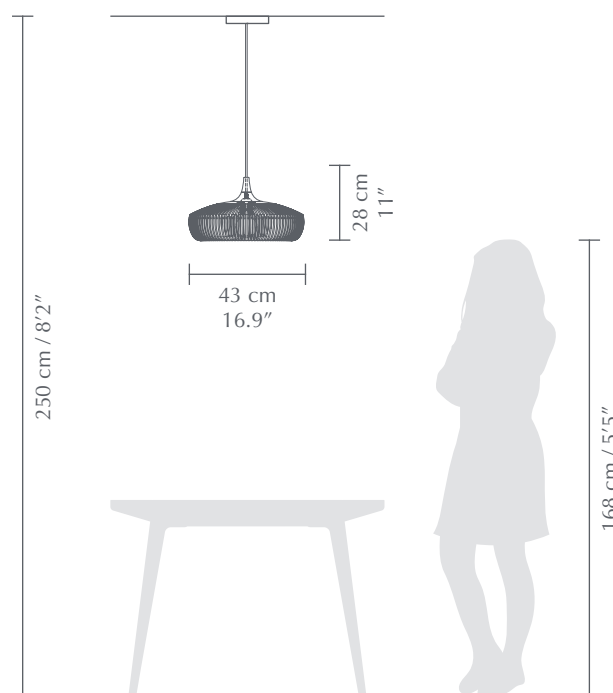

COLOUR VARIATIONS



oak ash



dark oak/ash



black oak/ash



CLAVA DINE

Designed by Søren Ravn Christensen

SIMPLE AND CHARACTERISTIC

Clava Dine™ is a simple, characteristic pendant lampshade with a graceful curved silhouette. The lampshade adds a nostalgic reference to the 70s with its perforated holes and soft ambient light.

With its exclusive and elegant look, Clava Dine™ creates a directional downward light making it fit perfectly over the dining table, above the kitchen counter, coffee table or in a restaurant, bringing a cosy and chic feeling.

The lampshade comes in black, white, brushed brass, brushed copper, polished steel, red earth, ochre, umber and slate. so it can lighten up any home.

Find more inspiration at page 60, 92



 Pendant lampshade
Compatible with E26 / E27

 **DIMENSIONS**
Ø: 43 cm / 17" x H: 28 cm / 11"

 **MATERIAL**
Aluminium

 **WEIGHT INCL. PACKAGING**
2.3 kg

 **LIGHT SOURCE**
E26 / E27 - max 15W LED (not included)

 **PACKAGING DIMENSIONS (L x W x H)**
45.7 x 45.7 x 14.7 cm / 18 x 18 x 5.8"

 **ASSEMBLY TIME**
5 min - video guide at umage.com

 **MEDIA KIT**
Photos and press material
Download at umagepress.com

ORDERING INFORMATION

Clava Dine matt white	EU/UK/US/APAC #2076
Clava Dine polished steel	EU/UK/US/APAC #2097
Clava Dine polished copper	EU/UK/US/APAC #2098
Clava Dine brushed brass	EU/UK/US/APAC #2099
Clava Dine red earth	EU/UK/US/APAC #2301
Clava Dine ochre	EU/UK/US/APAC #2302
Clava Dine umber	EU/UK/US/APAC #2303
Clava Dine slate	EU/UK/US/APAC #2304
Clava Dine black	EU/UK/US/APAC #2217

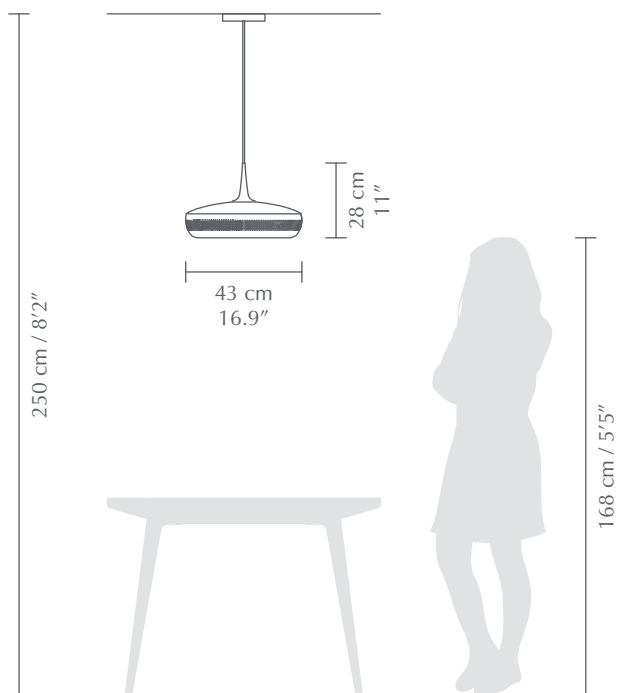

COLOUR VARIATIONS



matt white



polished steel



polished copper



polished brass



slate
(RAL: 7000)



ochre
(RAL: 070 70 40)



umber
(RAL: 7006)



red earth
(RAL: 030 50 40)



black



CLAVA

Designed by Søren Ravn Christensen

A STYLISH LAMPshade

Clava™ is a small and stylish lampshade with retro hints. A series of small symmetric holes supplies a stunning look to the surroundings. Clava™ comes in white, brushed brass, brushed copper or polished steel, all colours making it perfect for beautiful clusters.

Find more inspiration at page 11, 30



Pendant lampshade
Compatible with E26 / E27



DIMENSIONS
Ø: 21.5 cm / 8.5" x H: 33 cm / 13"



MATERIAL
Aluminium



WEIGHT INCL. PACKAGING
1.3 kg / 2.9 lb



LIGHT SOURCE
E26 / E27 - max 15W LED (not included)



PACKAGING DIMENSIONS (L x W x H)
24.6 x 32.6 x 14.3 cm / 9.7 x 12.8 x 5.6"



ASSEMBLY TIME
5 min - video guide at umage.com



MEDIA KIT
Photos and press material
Download at umagepress.com



ORDERING INFORMATION

Clava matt white	EU/UK/US/APAC #2051
Clava polished steel	EU/UK/US/APAC #2110
Clava polished copper	EU/UK/US/APAC #2111
Clava brushed brass	EU/UK/US/APAC #2112

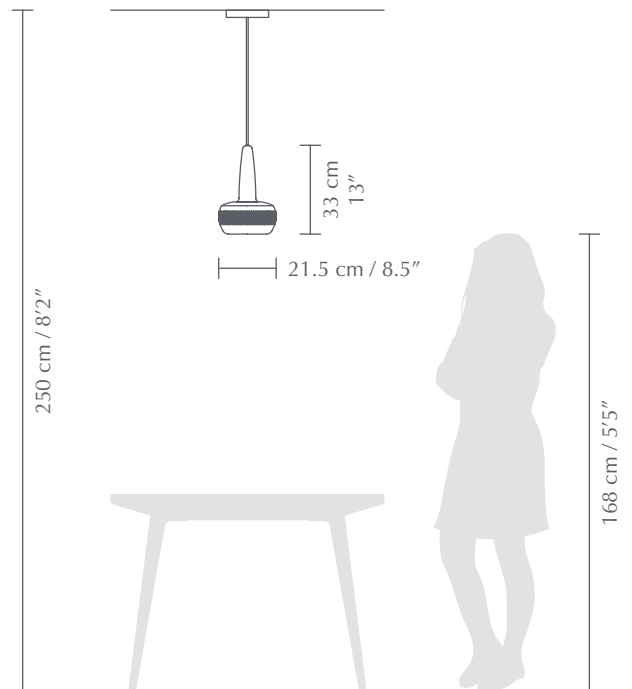
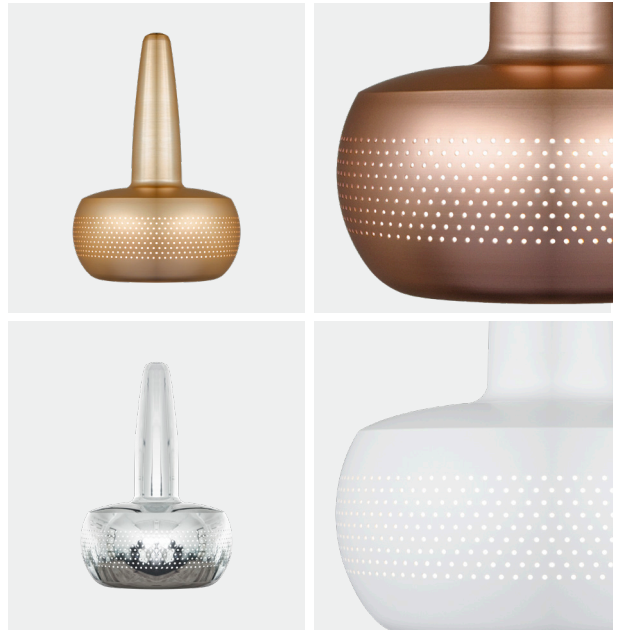

COLOUR VARIATIONS



matt white



polished steel



polished copper



polished brass

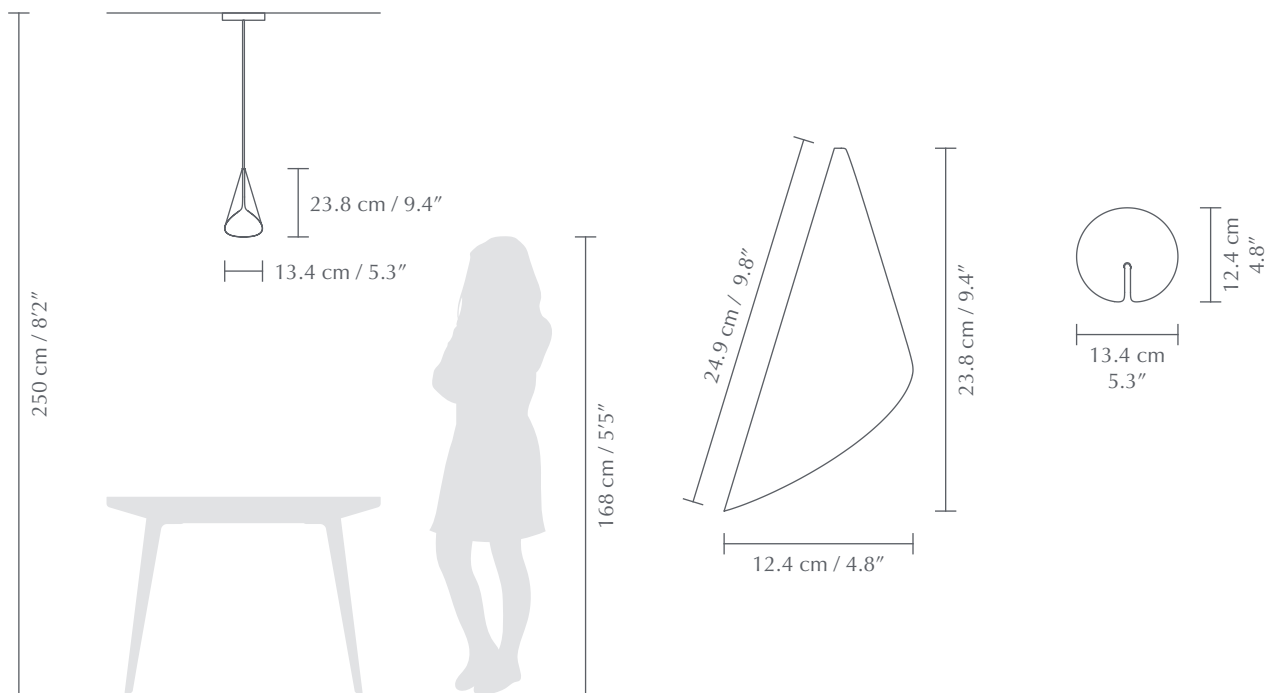

CORNET

Designed by Jacob Johan Würtzen

FLEXIBILITY IN A CONE

Cornet is a flexible lampshade consisting of two metal cones that can be rotated and swapped around to give the light and look you seek.

The downward light of the Cornet can be controlled and adjusted sideways by rotating the two screens, to illuminate specific points of the interior, making it perfect above the kitchen counter or beside your favourite reading chair.

Find more inspiration at page 75



Pendant lampshade
Compatible with E26 / E27



DIMENSIONS (H x W x D)
23.8 x 13.4 x 12.4 cm / 9.4 x 5.3 x 4.8"



MATERIAL
Aluminium



WEIGHT INCL. PACKAGING
830 g / 1.8 lb



LIGHT SOURCE
E26 / E27 - max 15W LED (not included)



PACKAGING DIMENSIONS (L x W x H)
15 x 27.1 x 10.7 cm / 5.9 x 10.7 x 4.2"



ASSEMBLY TIME
2 min



MEDIA KIT
Photos and press material
Download at umagepress.com



ORDERING INFORMATION
Cornet white brass EU/UK/US/APAC #2194
Cornet black brass EU/UK/US/APAC #2195

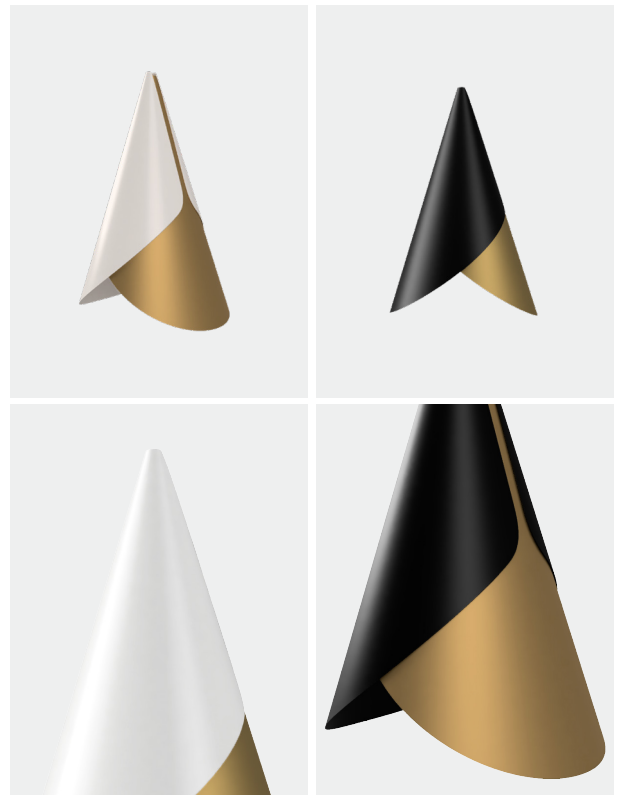

COLOUR VARIATIONS



black brass



white brass



CUNA

Designed by UIMAGE Design Team

SCULPTURAL DETAILS

Cuna combines sculptural details with soft diffuse lighting. Made from powder-coated steel with all parts hanging on to each other without assembly - only gravity is in use. Cuna is a timeless Scandinavian piece of design that places functional lighting first.



Pendant lampshade
Compatible with E26 / E27



DIMENSIONS
Ø: 38 cm / 15" x H: 16 cm / 6.3"



MATERIAL
Steel and Acrylic



WEIGHT INCL. PACKAGING
2 kg / 1,3 lb



LIGHT SOURCE
E26 / E27 - max 15W LED (not included)



PACKAGING DIMENSIONS (L x W x H)
38.8 x 38.8 x 8.8 cm / 15.3 x 15.3 x 3.5"



ASSEMBLY TIME
5 min - video guide at umage.com



MEDIA KIT
Photos and press material
Download at umagepress.com



ORDERING INFORMATION
Cuna matt white EU/UK/US/APAC #2034
Cuna matt black EU/UK/US/APAC #2035
Cuna mint green EU/UK/US/APAC #2036

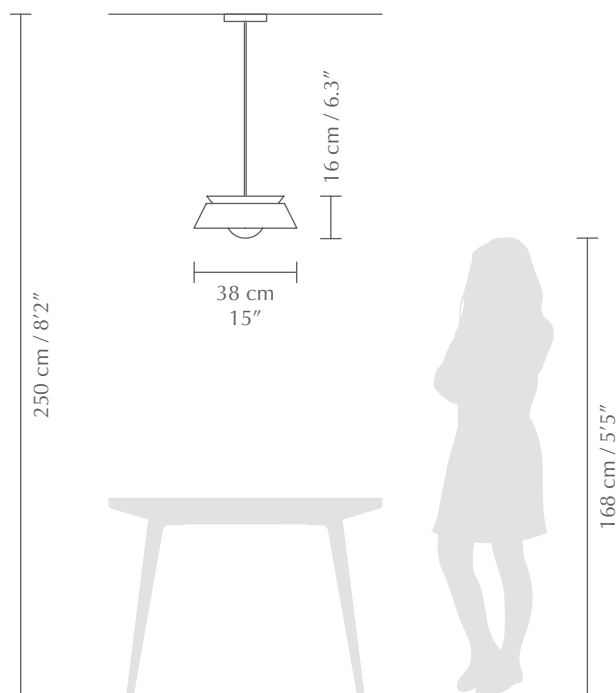

COLOUR VARIATIONS



matt white



matt black



mint green

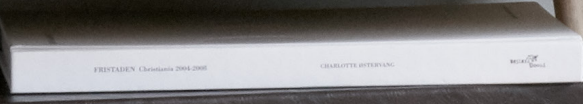
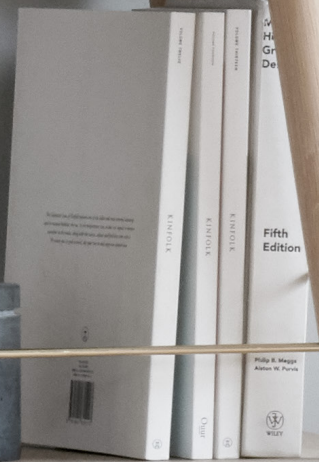

SHADE

Designed by Søren Ravn Christensen

A CELEBRATION OF LIGHT

Sometimes, to get the perfect light, you need the perfect shade. The Shade is meant to do just that! This design piece combines aesthetics with functionality and ensures a simple, useful accessory for the lightbulb. Used on a pendant bulb or tripod, the Shade will help you adjust the direction and amount of light, while shielding any unwanted glare. All you have to do is fine-tune the position of the Shade on the lightbulb. What bulb would be the best companion? The Idea 3W 125 mm.



Pendant, floor and table lampshade
Compatible with E26 / E27



Flip 180°



Durable



DIMENSIONS

Ø: 33 cm / 13" x H: 3.3 cm / 1.3"



MATERIAL

PET felt



WEIGHT INCL. PACKAGING

480 g / 1 lb



LIGHT SOURCE

E26 / E27 - max 15W LED (not included)



PACKAGING DIMENSIONS (L x W x H)

33.6 x 33.6 x 4 cm / 13.2 x 13.2 x 1.6"



ASSEMBLY TIME

15 min - video guide at umage.com



MEDIA KIT

Photos and press material
Download at umagepress.com



ORDERING INFORMATION

Shade felt

EU/UK/US/APAC #2107

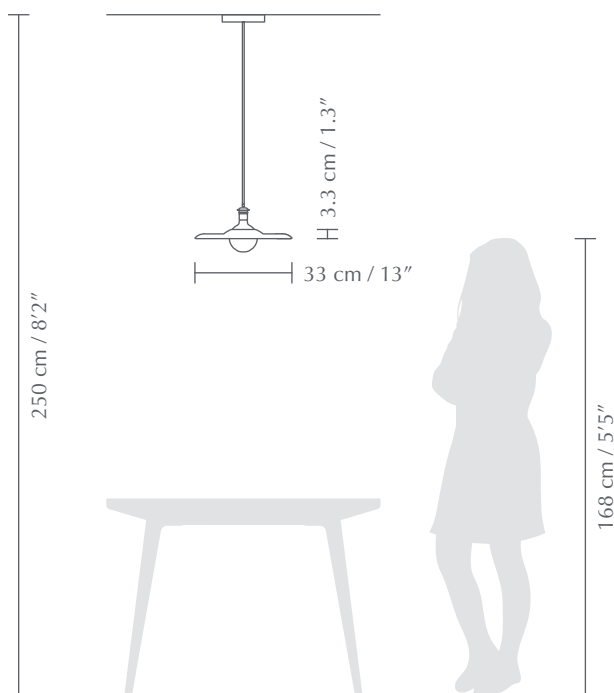

COLOUR VARIATIONS



grey



SINE

Designed by Miklós Leits

A PERPETUAL DANCE OF SYMMETRY AND ASYMMETRY

See, touch, feel, embrace. It's easy to let your mind wander and your eyes undulate to the rhythm of the Sine, a lampshade designed to lure and engage your senses. Its harmonious organic pattern contrasts symmetry and asymmetry, dark and light, grey and white, ups and downs, creating a remarkably different look depending on the angle from which it's viewed, and imprinting an apparent motion and a dynamic vibe to the lamp.

The tactile sense is as much delighted as the sight sense. The smooth layer of felt conveys a distinctive character and creates a cosy feel, evocative of the Nordic style and philosophy. Exquisite, intrinsically simple, yet with an attitude twist, Sine comes as a flat-packed lampshade that can be assembled without glue or any tools. Hidden zippers along the edges transform the 2D flat geometric shapes into a stunning 3D silhouette.

With an exclusive, yet playful design, and a completely glare-free glow, this lampshade can be placed in any spot, in any environment. All you have to do is to see, touch, feel, love.

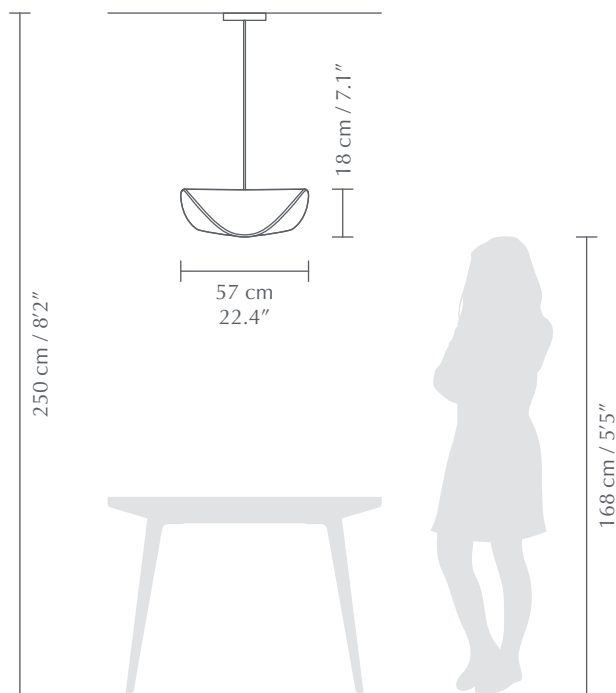

Pendant lampshade
Compatible with E26 / E27



Durable



DIMENSIONS
Ø: 57 cm / 22.4" x H: 18 cm / 7"



MATERIAL
Felt and Polypropylene



WEIGHT INCL. PACKAGING
1.9 kg / 4.2 lb



LIGHT SOURCE
E26 / E27 - max 15W LED (not included)



PACKAGING DIMENSIONS (L x W x H)
16.5 x 16.5 x 73.5 cm / 6.5 / 6.5 x 29"



ASSEMBLY TIME
20 min - video guide at umage.com



MEDIA KIT
Photos and press material
Download at umagepress.com



ORDERING INFORMATION
Sine EU/UK/US/APAC #2084

COLOUR VARIATIONS



grey

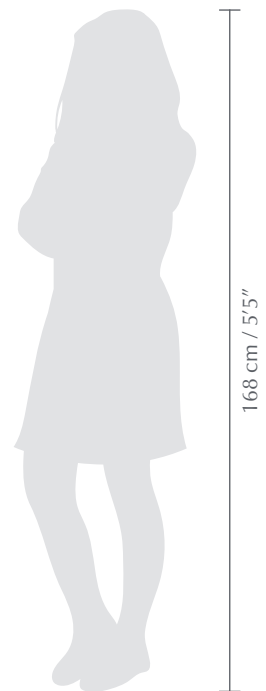
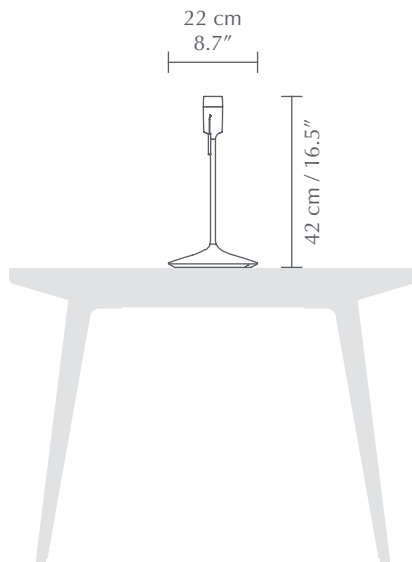

CHAMPAGNE | LIGHT STAND

Designed by Anders Klem

INSPIRED BY THE DELICATE STEM OF A CHAMPAGNE FLUTE

Inspired by the delicate stem of a Champagne flute, this simple light stand has been designed as an elegant accent for any corner of the home.

The lightweight yet sturdy stand has a classic pull-switch, adding a traditional detail to its clean, contemporary shape. The Champagne table has a hidden, integral USB-port so you can charge your phone or tablet, even when the light is turned off.

The Champagne can be paired with a large variety of our UIMAGE lampshades.

Find more inspiration at page 12, 23, 25, 45, 95, 104



Light stand
Comes with E26 / E27



TESTS & CERTIFICATIONS
CE (for indoor use), IP2X, UL / cUL certified



Champagne table: USB power supply incl.



DIMENSIONS
Ø: 38 cm / 15" Ø: 22 cm / 8.7"
H: 140 cm / 55.1" H: 42 cm / 16.5"



MATERIAL
Aluminium, Steel, MDF and ABS



WEIGHT INCL. PACKAGING
Champagne floor: 3.7 kg / 8.2 lb
Champagne table: 1.7 kg / 3.7 lb



LIGHT SOURCE
E26 / E27 - max 15W LED (not included)



PACKAGING (L x W x H)
Champagne floor: 41.8 x 41.8 x 10 cm / 16.5 x 16.5 x 3.9"
Champagne table: 26 x 41.5 x 8.8 cm / 10.2 x 16.3 x 3.5"



ASSEMBLY TIME
10-15 min - video guide at umage.com



MEDIA KIT
Photos and press material
Download at umagepress.com



ORDERING INFORMATION
Champagne floor:
White EU/APAC #4035 / UK #4043 / US #4037
Black EU/APAC #4036 / UK #4044 / US #4038
Brushed steel EU/UK/APAC #4047 / US #4161
Brushed brass EU/UK/APAC #4048 / US #4160

Champagne table:
White EU/UK/APAC #4045 / US #4104
Black EU/UK/APAC #4046 / US #4105
Brushed steel EU/UK/APAC #4050 / US #4106
Brushed brass EU/UK/APAC #4052 / US #4107

Colour variations



white
(RAL: 9003)



black
(RAL: 9005)



brushed steel



brushed brass

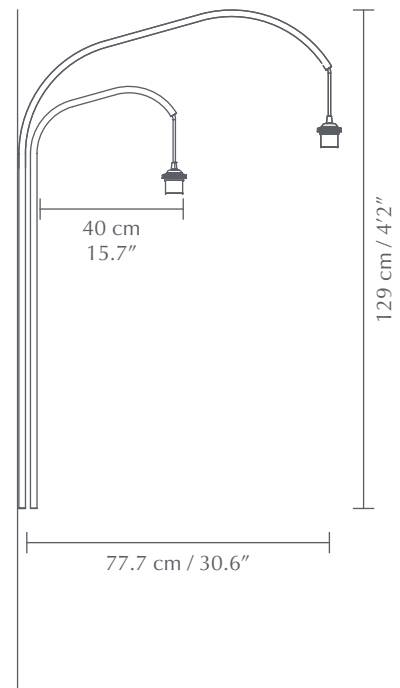
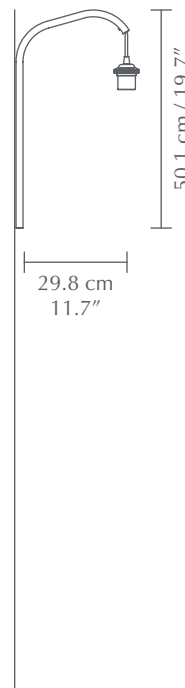
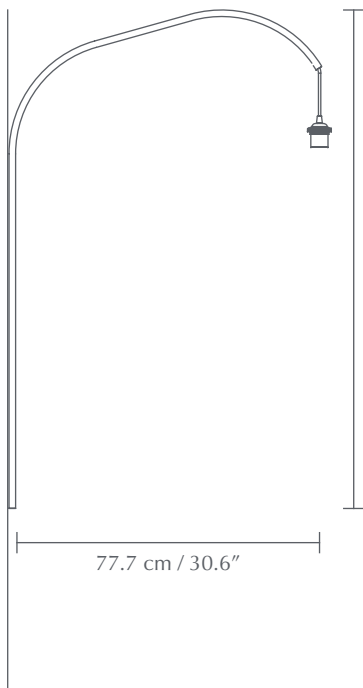

WILLOW | LIGHT STAND

Designed by Søren Ravn Christensen

FLEXIBILITY ON THE WALL

With its subtle and minimal design, Willow lets you mount a lampshade without having to install extra electric cables inside your wall or ceiling.

This sturdy accessory will make it possible to have one of your favourite UIMAGE pendant lamps hanging in various positions.

Place it near the bed, or behind the couch, or in a corner... anywhere! Available in either black or white, Willow fits a big range of interior décors. Practical cosiness, at its best.

Find more inspiration at page 29

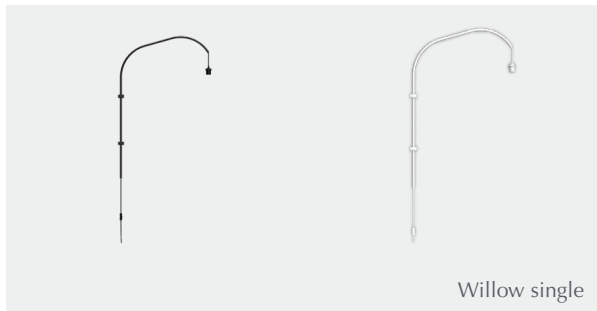
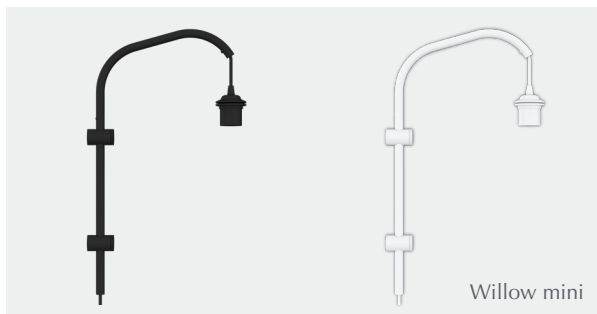

Wall mounted light stand



TESTS & CERTIFICATIONS

CE (for indoor use), IP2X, cULus certified



DIMENSIONS

Mini: D: 29.8 cm / 11.7" H: 50.1 cm / 19.7"

Single: D: 77.7 cm / 30.6" H: 123 cm / 48.5"

Double: D: 40 / 77.7 cm / 15.7 / 30.6" H: 123 cm / 48.5"



MATERIAL

Steel and Aluminium

Incl. 1.3 m / 4'3" black textile cord



WEIGHT INCL. PACKAGING

Mini: 1.2 kg / 2.6 lb

Single: 3 kg / 6.6 lb

Double: 3.6 kg / 7.9 lb



LIGHT SOURCE

E26 / E27 - max 15W LED (not included)



PACKAGING DIMENSIONS (W x H x D):

Mini: 42.7 x 7 x 23 cm / 16.8 x 2.8 x 9.1"

Single/Double: 88.5 x 8.5 x 34 cm / 34.8 x 3.3 x 13.4"



ASSEMBLY TIME

10-15 min - video guide at umage.com



MEDIA KIT

Photos and press material

Download at umagepress.com



ORDERING INFORMATION

Mini white EU/APAC #4150 / UK #4154 / US N/A

Mini black EU/APAC #4151 / UK #4155 / US N/A

Single white EU/APAC #4110 / UK #4146 / US #4132

Single black EU/APAC #4111 / UK #4147 / US #4133

Double white EU/APAC #4130 / UK #4148 / US #4134

Double black EU/APAC #4131 / UK #4149 / US #4135

COLOUR VARIATIONS



white



black

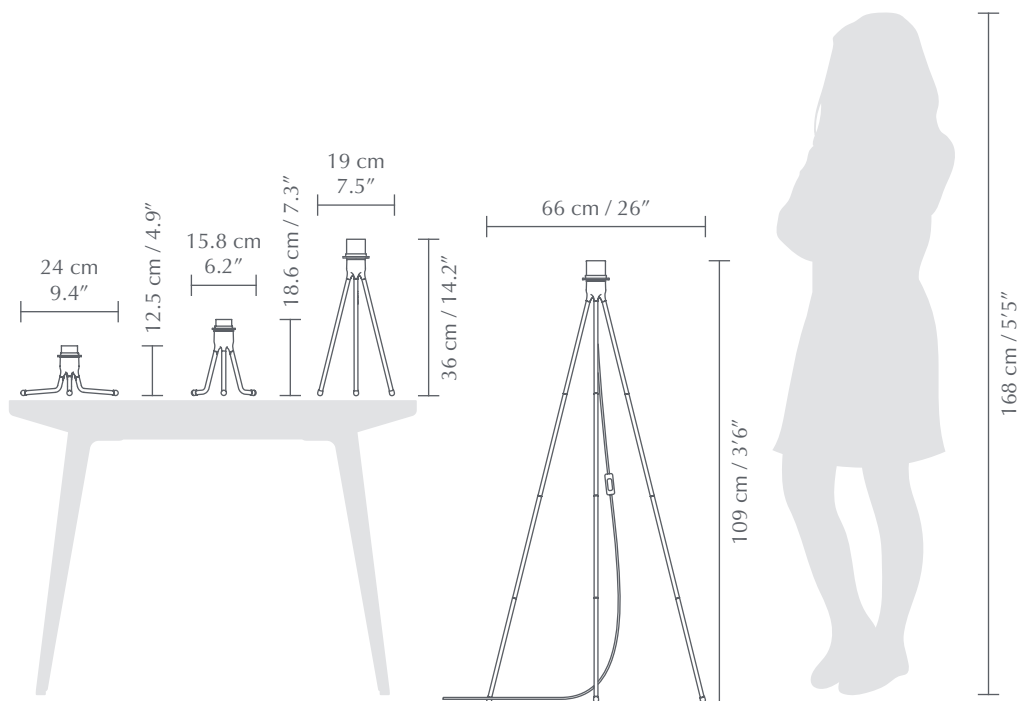

TRIPOD | LIGHT STAND

Designed by Søren Ravn Christensen

A BEAUTIFUL LIGHT STAND

The Tripod collection lets you turn your UIMAGE lampshade into a table or floor lamp in just seconds. The ingenious construction of the Tripod ships in compact packaging and snaps together automatically in a few seconds upon unpacking. Available in black or white.

Find more inspiration at page 18, 22, 44, 80, 83

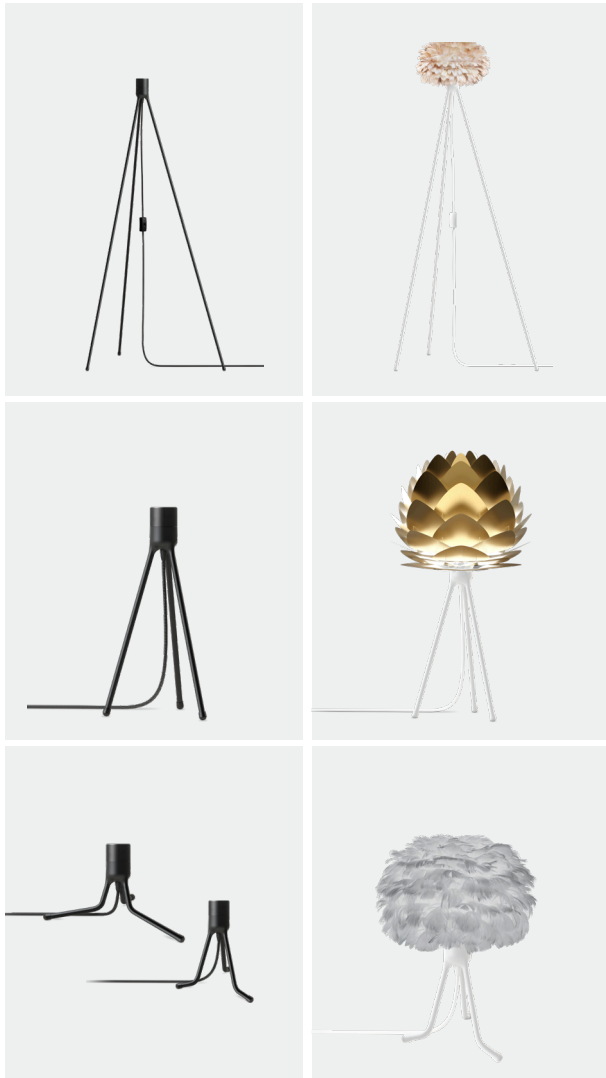

Light stand
Comes with E26 / E27



Base: Flip legs 180°



TESTS & CERTIFICATIONS

CE (for indoor use), IP2X, cETLus certified



DIMENSIONS

Base: Ø 24 / 15.8 cm / 9.4 / 6.2"
H: 12.5 / 18.6 cm / 4.9 / 7.3"
Table: Ø: 19 cm / 7.4" H: 36 cm / 14.1"
Floor: Ø: 66 cm / 26" H: 109 cm / 42.9"



MATERIAL

Aluminium



WEIGHT INCL. PACKAGING

Base: 630 g / 1.4 lb
Table: 630 g / 1.4 lb
Floor: 800 g / 1.8 lb



LIGHT SOURCE

E26 / E27 - max 15W LED (not included)



PACKAGING DIMENSIONS (L x W x H)

Base: 16.6 x 16.6 x 9.3 cm / 6.5 x 6.5 x 3.7"
Table: 6.8 x 6.8 x 40 cm / 2.7 x 2.7 x 15.7"
Floor: 7.8 x 7.8 x 42.5 cm / 3.1 x 3.1 x 16.7"



ASSEMBLY TIME

5 min - video guide at umage.com



MEDIA KIT

Photos and press material
Download at umagepress.com



ORDERING INFORMATION

Base white EU/UK/APAC #4053 / US #4055
Base black EU/UK/APAC #4054 / US #4056
Table white EU/APAC #4021 / UK #4021+4027 / US #4023
Table black EU/APAC #4022 / UK #4022+4028 / US #4024
Floor white EU/UK/APAC #4015 / US #4011
Floor black EU/UK/APAC #4016 / US #4012

COLOUR VARIATIONS



white



black

NEW



UNIFIER | Qi WIRELESS CHARGER

Designed by UIMAGE Design Team

PRACTICAL, SIMPLE AND ELEGANT

The Unifier™ charging unit offers wireless Qi charging of everything from the Asteria Move™ lamp to your smartphone and all other Qi supported technology. You simply charge your devices, without any cords, by placing it directly on the pad. The LED light on the Unifier™ lets you monitor the charging process.

The Unifier™ is available in white/rose gold or black/chrome and it delivers a stable output, up to 10W.



TESTS & CERTIFICATIONS

CE (for indoor use)



DIMENSIONS

Ø: 9.9 cm / 3.9"
H: 0.7 cm / 0.3"



MATERIAL

Aluminium and PC



WEIGHT INCL. PACKAGING

164 g / 5.8 oz



PACKAGING

Gift box dimensions (L x W x H):
12.8 x 12.8 x 2.9 cm / 5 x 5 x 1.1"



ASSEMBLY TIME

1 min - video guide at umage.com



MEDIA KIT

Photos and press material
Download at umagepress.com



ORDERING INFORMATION

Unifier black chrome EU/UK/APAC #4185 / US N/A
Unifier white rose gold EU/UK/APAC #4186 / US N/A

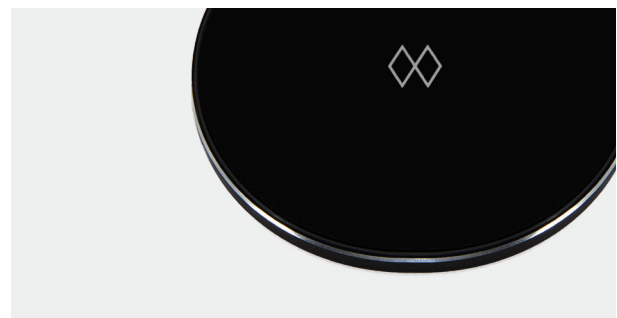
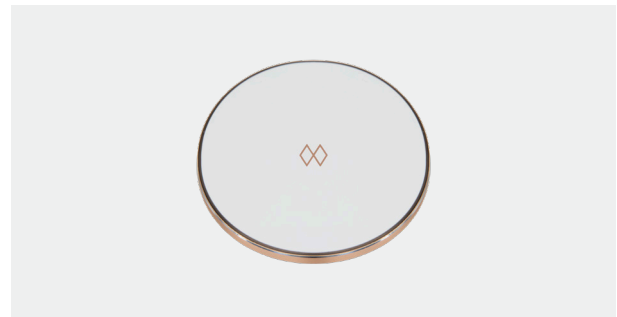
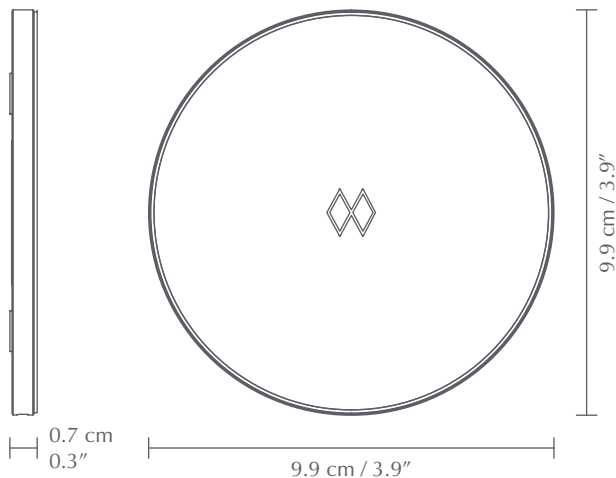

Colour variations



black
chrome



white
rose gold



CANNONBALL | CANOPY

Designed by Søren Ravn Christensen

A UNIQUE CANOPY

Inspired by the perfectly round shape of a sphere, Cannonball is a discreet and organic canopy created for pendant lights. With its timeless design and smooth, alluring feel, this silicone canopy serves a double purpose: a loop-in lighting wiring system and a unique way to decorate the pendant cord.



TESTS & CERTIFICATIONS

CE (for indoor use), IP2X



DIMENSIONS

Ø: 12 cm



MATERIAL

Silicone
2.5 m / 8'2" textile cord, fitting and E27 socket



WEIGHT INCL. PACKAGING

Cannonball: 660 g
Cluster 2: 840 g
Cluster 3: 1 kg



LIGHT SOURCE

E27 - max 15W LED (not included)



PACKAGING DIMENSIONS (L x W x H):

Cannonball: 13.5 x 13.5 x 12.5 cm
Cluster 2: 13.5 x 25 x 13.5 cm
Cluster 3: 13.5 x 25 x 13.5 cm



ASSEMBLY TIME

10 min - video guide at umage.com



MEDIA KIT

Photos and press material
Download at umagepress.com



ORDERING INFORMATION

Cannonball white	EU/UK/APAC #4031 / US N/A
Cannonball black	EU/UK/APAC #4032 / US N/A
Cannonball cluster 2 white	EU/UK/APAC #4089 / US N/A
Cannonball cluster 2 black	EU/UK/APAC #4091 / US N/A
Cannonball cluster 3 white	EU/UK/APAC #4090 / US N/A
Cannonball cluster 3 black	EU/UK/APAC #4092 / US N/A

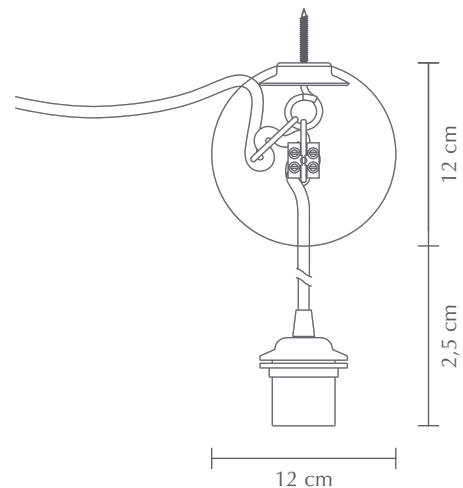
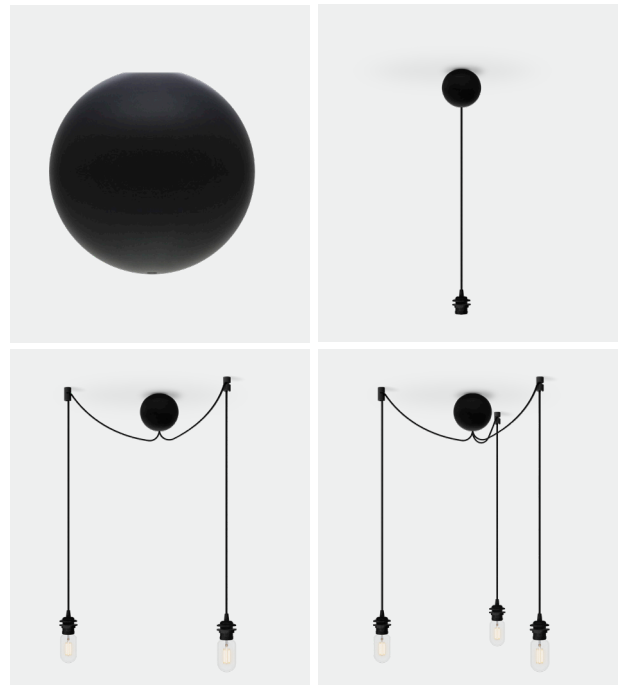

COLOUR VARIATIONS



white



black



ROSETTE / CANOPY

Designed by UIMAGE Design Team

MINIMAL AND FUNCTIONAL

Rosette is a metal canopy that brings the best of your lampshade without taking the spotlight away from it. Made from steel and available in both black and white, this canopy can be installed directly on an electric outlet or next to one. Just pair it with your favourite lampshade and put your home in the best light!



TESTS & CERTIFICATIONS

CE (for indoor use), IP2X, UL/cUL certified



DIMENSIONS

Ø: 14 cm / 5.5" x H: 2.5 cm / 1"



MATERIAL

2.1 m / 6'9" textile cord, a canopy and E27/E26 socket



WEIGHT INCL. PACKAGING

540 g / 1.2 lb



LIGHT SOURCE

EU item numbers: compatible with E27, max 15W LED
US item numbers: compatible with E26, max 15W LED



PACKAGING DIMENSIONS (L x W x H)

16.6 x 9.3 x 16.6 cm / 6.5 x 3.7 x 6.5"



MEDIA KIT

Photos and press material
Download at umagepress.com



ORDERING INFORMATION

Rosette / Canopy white EU/UK/APAC #4144 / US #4007
Rosette / Canopy black EU/UK/APAC #4145 / US #4008
Canopy nickel EU/UK/APAC N/A / US #4029
Canopy oil rubbed bronze EU/UK/APAC N/A / US #4030

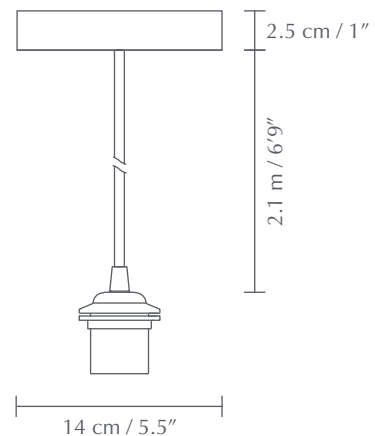

COLOUR VARIATIONS



white



black



nickel



oil rubbed
bronze

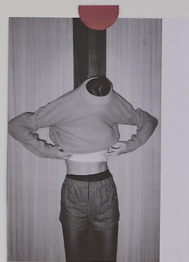

CORD SET | CANOPY

Designed by UIMAGE Design Team

CREATE YOUR OWN LIGHTING SOLUTION

This modern and minimal cord set consists of 2.1 meters of textile cord, a canopy and an E27 socket. Available in a black or white finish, add our Idea LED bulb and UIMAGE lampshade to create your own unique lighting solution that compliments your home.



Cord set for pendants
Compatible with E27



TESTS & CERTIFICATIONS
CE (for indoor use), IP2X



DIMENSIONS
Ø: 12 cm / 4.7" H: 7 cm / 3" L: 2.1 m / 83"



MATERIAL
Textile cord, ceiling rose and E27 socket



WEIGHT INCL. PACKAGING
2.5 kg



LIGHT SOURCE
E27 - max 15W LED (not included)



PACKAGING DIMENSIONS (L x W x H)
25 x 20 x 10 cm / 9 x 8 x 4"



ASSEMBLY TIME
10 min



MEDIA KIT
Photos and press material
Download at umagepress.com



ORDERING INFORMATION
Cord set white EU/UK/APAC #4005 / US N/A
Cord set black EU/UK/APAC #4006 / US N/A

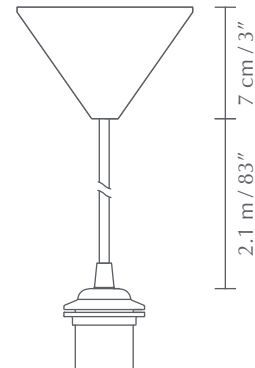

COLOUR VARIATIONS



white



black



SWAG KIT

Designed by UIMAGE Design Team

SWAG KIT WITH SWITCH AND PLUG

This modern and minimal cord set consists of 20' textile cord, plug and an E26 socket. Available in a black or white finish, add our Idea LED bulb and UIMAGE lampshade to create your own unique lighting solution that compliments your home.



Swag Kit with switch and plug
Compatible with E26



TESTS & CERTIFICATIONS
IP2X, cULus certified



DIMENSIONS
Ø: 12 cm / 4.7" H: 7 cm / 3" L: 2.1 m / 83"



MATERIAL
Textile cord



WEIGHT INCL. PACKAGING
2.5 kg



LIGHT SOURCE
E26 - max 15W LED (not included)



PACKAGING DIMENSIONS (L x W x H)
25 x 20 x 10 cm / 9 x 8 x 4"



ASSEMBLY TIME
1 min - video guide at umage.com



MEDIA KIT
Photos and press material
Download at umagepress.com



ORDERING INFORMATION
Swag Kit white EU/UK/APAC N/A / US #4009
Swag Kit black EU/UK/APAC N/A / US #4010

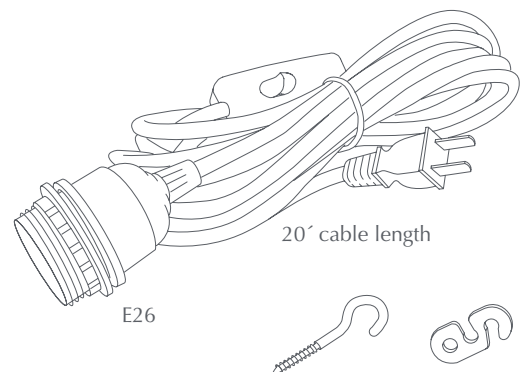

COLOUR VARIATIONS



white



black

IDEA 6W 60MM

Designed by UIMAGE Design Team



TESTS & CERTIFICATIONS

CE (for indoor use)



DIMENSIONS

Ø: 6 cm / 2.3"
H: 10.5 cm / 4.1"



LIGHT SOURCE

EU: E27 - 6W = 61W. 220-240V - 50 Hz - 2700K -
830 lm - 138 lm/W - RA: >82 - 15000 H



NUMBER OF SWITCHING CYCLES BEFORE PREMATURE LAMP FAILURE

7500



TIME TO FULL BRIGHTNESS

< 2 sec



Non-dimmable



POWER FACTOR

0.51



LUMEN MAINTENANCE FACTOR AT END OF NOMINAL LIFE TIME

0.7



PACKAGING DIMENSIONS (Ø x H)

6.8 x 12.4 cm / 2.7 x 5"



MEDIA KIT

Photos and press material
Download at umagepress.com



ORDERING INFORMATION

EU/UK/APAC: Idea 6W 60 mm LED bulb #4026

IDEA 6.5W 80MM

Designed by UIMAGE Design Team



TESTS & CERTIFICATIONS

CE (for indoor use), cULus certified



DIMENSIONS

Ø: 8 cm / 3.1"
H: 11.8 cm / 4.6"



LIGHT SOURCE

EU: E27 - 6.5W = 53W. 220-240V - 50 Hz - 2700 K
700 lm - 114 lm/W - RA: >82 - 15000 H



US: E26 - 7W = 55W. 110-130V- 60 Hz - 2700 K
550 lm - 80 lm/W - RA: >80 - 30000 H



NUMBER OF SWITCHING CYCLES BEFORE PREMATURE LAMP FAILURE

7500



TIME TO FULL BRIGHTNESS

< 2 sec



Non-dimmable



POWER FACTOR

0.52



LUMEN MAINTENANCE FACTOR AT END OF NOMINAL LIFE TIME

0.7



PACKAGING DIMENSIONS (Ø x H)

8.6 x 13.8 cm / 3.4 x 5.4"



MEDIA KIT

Photos and press material
Download at umagepress.com



ORDERING INFORMATION

EU/UK/APAC: Idea 6.5W 80 mm LED bulb #4033
US: Idea 7W 3.1" LED bulb #4042

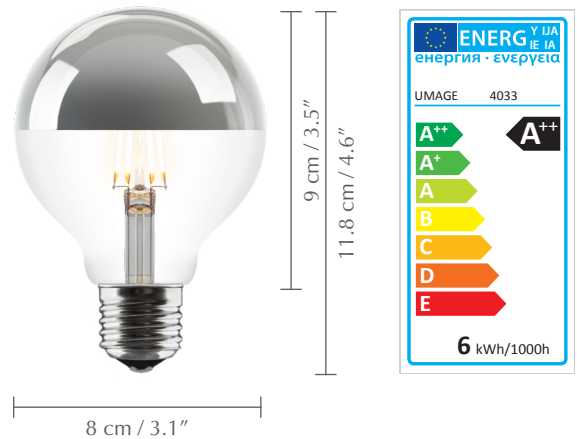
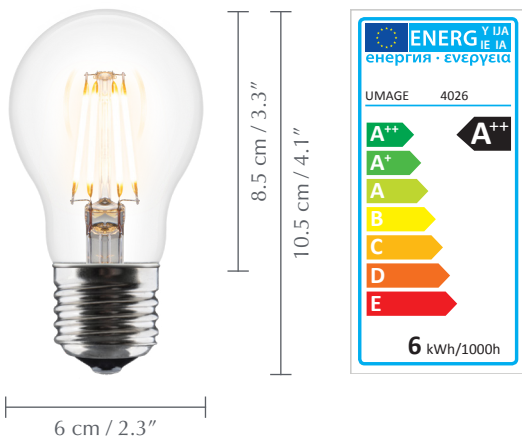

IDEA 3W 125MM

Designed by UIMAGE Design Team



TESTS & CERTIFICATIONS

CE (for indoor use), cULus certified



DIMENSIONS

Ø: 12.5 cm / 4.9"
H: 18 cm / 7.1"



LIGHT SOURCE

EU: E27 - 3W LED = 30W. 220-240V - 50 Hz - 2200 K
325 lm - 108 lm/W. RA: >83. 15000 H

US: E26 - 1.5W LED = 20W. 120V - 2200 K
140 lm - 93 lm/W. RA: 80. 30000 H



NUMBER OF SWITCHING CYCLES BEFORE PREMATURE LAMP FAILURE

7500



TIME TO FULL BRIGHTNESS

< 2 sec



Non-dimmable



POWER FACTOR

0.51



LUMEN MAINTENANCE FACTOR AT END OF NOMINAL LIFE TIME

0.7



PACKAGING DIMENSIONS (Ø x H)

13.9 x 19.9 cm / 5.5 x 7.8"



MEDIA KIT

Photos and press material
Download at umagepress.com



ORDERING INFORMATION

EU/UK/APAC: Idea 3 W 125 mm LED bulb #4034
US: Idea 1.5 W 4.9" LED bulb #4103

IDEA 2W 45MM

Designed by UIMAGE Design Team



TESTS & CERTIFICATIONS

CE (for indoor use), UL/cUL certified



DIMENSIONS

Ø: 4.5 cm / 1.7"
H: 10.8 cm / 4.3"



LIGHT SOURCE

EU: E27 - 2W LED = 15W. 220-240V - 50 Hz - 2200 K
140 lm - 65 lm/W. RA: >93. 25000 H

US: E26 - 1.5W LED = 20W. 110-130V - 60 Hz - 2200 K
140 lm - 93 lm/W. RA: >80. 30000 H



NUMBER OF SWITCHING CYCLES BEFORE PREMATURE LAMP FAILURE

15000



TIME TO FULL BRIGHTNESS

< 2 sec



Non-dimmable



POWER FACTOR

0.85



LUMEN MAINTENANCE FACTOR AT END OF NOMINAL LIFE TIME

0.7



PACKAGING DIMENSIONS (Ø x H)

5.8 x 12.5 cm / 2.3 x 5"



MEDIA KIT

Photos and press material
Download at umagepress.com



ORDERING INFORMATION

EU/UK/APAC: Idea 2W 45 mm LED bulb #4039
US: Idea 1.5W 1.7" LED bulb #4040

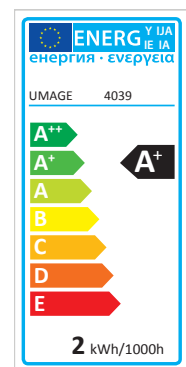
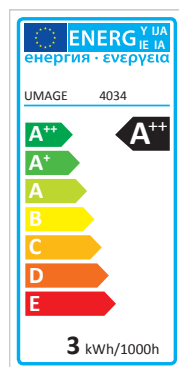

IDEA 4W 45MM

Designed by UIMAGE Design Team

IDEA 13W 70MM

Designed by UIMAGE Design Team



TESTS & CERTIFICATIONS

CE (for indoor use)



TESTS & CERTIFICATIONS

CE (for indoor use)



DIMENSIONS

Ø: 4.5 cm / 1.7"

H: 6 cm / 2.4"



DIMENSIONS

Ø: 7 cm / 2.8"

H: 13.4 cm / 5.3"



LIGHT SOURCE

EU: E14 - 4W LED = 41W. 220-240V - 50 Hz - 2700 K
480 lm - 120 lm/W. RA: >80. 15000 H



LIGHT SOURCE

EU: E27 - 13W LED = 103W. 220-240V - 50 Hz - 4000 K
1580 lm - 122 lm/W. RA: >80. 25000 H



NUMBER OF SWITCHING CYCLES BEFORE PREMATURE LAMP FAILURE

15000



NUMBER OF SWITCHING CYCLES BEFORE PREMATURE LAMP FAILURE

12500



TIME TO FULL BRIGHTNESS

< 2 sec



TIME TO FULL BRIGHTNESS

< 1 sec



Non-dimmable



Non-dimmable



POWER FACTOR

0.53



POWER FACTOR

0.55



LUMEN MAINTENANCE FACTOR AT END OF NOMINAL LIFE TIME

0.7



LUMEN MAINTENANCE FACTOR AT END OF NOMINAL LIFE TIME

0.7



PACKAGING DIMENSIONS (Ø x H)

5.8 x 9.4 cm / 2.3 x 3.7"



PACKAGING DIMENSIONS (Ø x H)

8.8 x 15 cm / 3.5 x 5.9"



MEDIA KIT

Photos and press material
Download at umagepress.com



MEDIA KIT

Photos and press material
Download at umagepress.com



ORDERING INFORMATION

Idea 4W 45 mm LED bulb EU/UK/APAC #4079 / US N/A



ORDERING INFORMATION

Idea 13W 70 mm LED bulb EU/UK/APAC #4136 / US N/A



4.5 cm / 1.7"



6 cm / 2.4"

7.8 cm / 3.1"

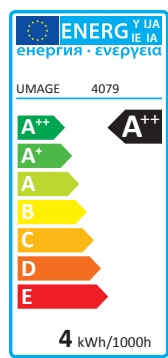

7 cm / 2.8"



10.5 cm / 4.1"

13.4 cm / 5.3"

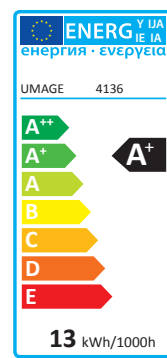

IDEA 2W 80MM

Designed by UIMAGE Design Team



TESTS & CERTIFICATIONS

CE (for indoor use)



DIMENSIONS

Ø: 8 cm / 3.1"
H: 12.1 cm / 4.8"



LIGHT SOURCE

E26 / E27 - 2W LED = 15W. 220-240V - 50 Hz - 2200 K
145 lm - 68 lm/W. RA: >90. 25000 H



NUMBER OF SWITCHING CYCLES BEFORE PREMATURE LAMP FAILURE

15000



TIME TO FULL BRIGHTNESS

< 1 sec



Non-dimmable



POWER FACTOR

0.96



LUMEN MAINTENANCE FACTOR AT END OF NOMINAL LIFE TIME

0.7



PACKAGING DIMENSIONS (Ø x H)

8.7 x 13.8 cm / 3.4 x 5.4"



MEDIA KIT

Photos and press material
Download at umagepress.com



ORDERING INFORMATION

Idea 2W 80 mm LED bulb EU/UK #4170 / US N/A



8 cm / 3.1"

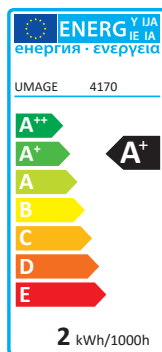

4 cm / 1.6"

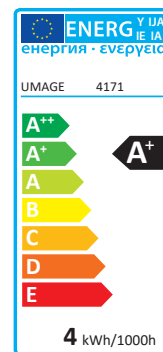

TESTS & CERTIFICATIONS

CE (for indoor use)



DIMENSIONS

Ø: 4 cm / 1.6"
H: 6.2 cm / 2.4"



LIGHT SOURCE

E27 - 4W LED = 40W. 220-240V - 50 Hz - 2700 K
260 lm - 65 lm/W. RA: >80. 25000 H



NUMBER OF SWITCHING CYCLES BEFORE PREMATURE LAMP FAILURE

15000



TIME TO FULL BRIGHTNESS

< 1 sec



Non-dimmable



POWER FACTOR

0.86



LUMEN MAINTENANCE FACTOR AT END OF NOMINAL LIFE TIME

0.7



PACKAGING DIMENSIONS (Ø x H)

5.5 x 8.9 cm / 2.2 x 3.5"



MEDIA KIT

Photos and press material
Download at umagepress.com



ORDERING INFORMATION

Idea 4W 40 mm LED bulb EU/UK #4171 / US N/A

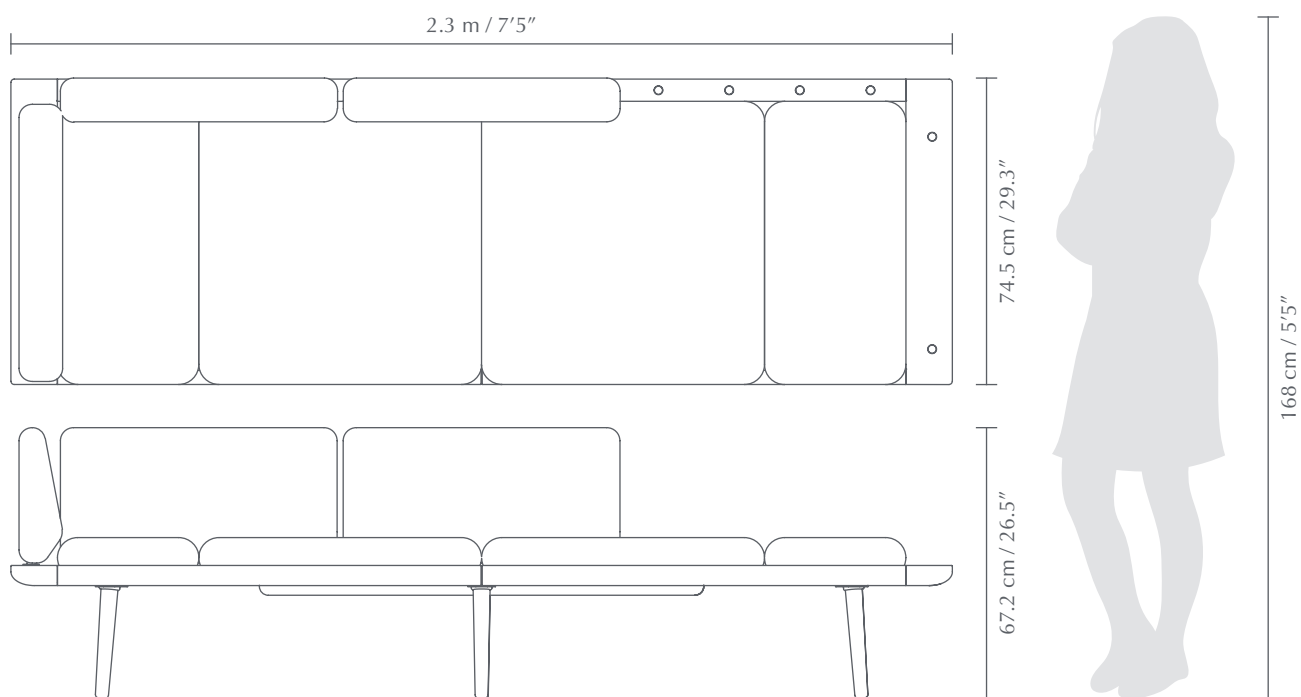

LOUNGE AROUND | 3-SEATER

Designed by Søren Ravn Christensen

THE LOUNGE AROUND 3-SEATER SOFA IS ALL YOU NEED FOR TRUE URBAN LIVING

Lounge Around is a multifunctional, flexible sofa designed to be the centrepiece of your living room. After a busy day it's the perfect place to lie back, relax and recharge.

Lounge Around's slim size and multifunctionality makes it perfect in all sorts of living rooms, bedrooms and guest rooms whether large or small. It is also ideal for use in a summer house, as a hotel daybed or as a couch in a reception area or waiting room.

With the Lounge Around accessories you can add extra functionality to the Lounge Around sofa. Add the Round Table, so you have an extra side table close by, for your laptop or a cup of tea. The Side Pocket offers storage for your weekly newspapers and magazines. Enhance the ambiance by the Lounge Around with the Light Around lamp.

All accessories for the Lounge Around can be modulated and placed exactly where you need it, by using the holes in the back and on the sides of the sofa. When the holes are not used for the Lounge Around accessories, they can be covered by brass brackets included when buying Lounge Around.

Find more inspiration at page 39, 46, 92



COLOUR VARIATIONS



oak



dark oak



TESTS & CERTIFICATIONS

EU: Passed EN 16139 (L1) / EN 1022



DIMENSIONS (H x W x D)

40.3 x 231.6 x 74.5 cm / 15.9 x 91.2 x 29.3"



Flip 180°

Reversible cushion with a thin tray on the reverse side



MATERIAL & UPHOLSTERY

Solid oak, MDF, Steel (plated brass). Polyester in slate grey / dark grey (Marbella). Find more information in the Marbella fabric spec sheet page 256.



CONSTRUCTION

Frame: Solid oak, MDF and steel (plated brass). Tongue and groove, mortise and tenon, dowel joinery. Reinforced with glue and screws. Clear top coat wood finish. **Backrest:** Loose. Steel frame with 38 kg 170 Newton foam. **Seat cushion:** Loose. Core of 38 kg 170 Newton foam, top filling 30% feathers and 70% airblown polyester ball fiber. **Back cushion:** Loose. Airblown polyester ball fiber.



WEIGHT INCL. PACKAGING

Box 1: 38.5 kg / 84.9 lb
Box 2: 12.8 kg / 28.2 lb
Box 3: 21 kg / 46.3 lb



PACKAGING DIMENSIONS (L x W x H)

Box 1: 90 x 137 x 17 cm / 35.4 x 54 x 6.7"
Box 2: 74 x 78 x 41 cm / 29 x 31 x 16"
Box 3: 74 x 78 x 41 cm / 29 x 31 x 16"



ASSEMBLY TIME

30 min - video guide at umage.com



MEDIA KIT

Photos and press material
Download at umagepress.com

ORDERING INFORMATION

Oak EU/APAC #5550+5550-1+5550-2
US #5550+5560-1+5560-2
UK #5550+5551-1+5551-2
Dark oak EU/APAC #5750+5550-1+5550-2
US #5750+5560-1+5560-2
UK #5750+5551-1+5551-2



RECOMMENDED ACCS.

Light Around white EU/UK/APAC #5400 US #5408
Light Around black EU/UK/APAC #5401 US #5409
Side Pocket EU/UK/US/APAC #5402
Round Table oak EU/UK/US/APAC #5403
Round Table dark oak EU/UK/US/APAC #5404
Lean Back EU/APAC #5405 UK #5406 US #5407

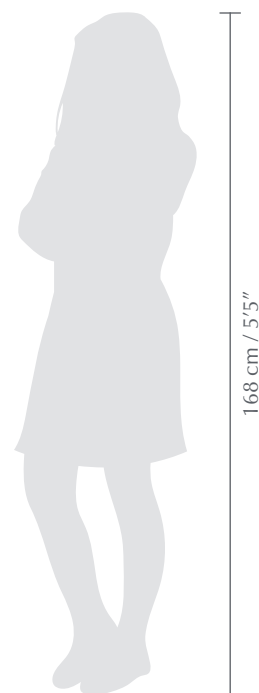
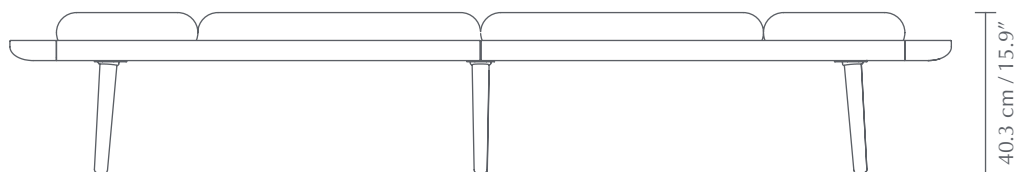
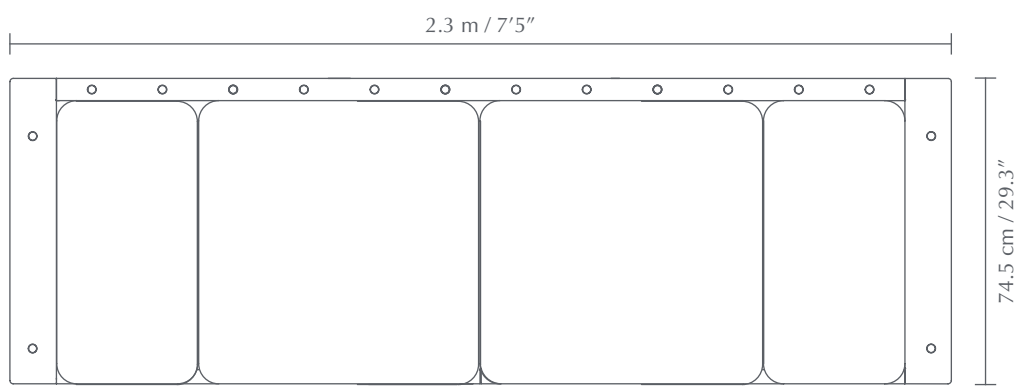

LOUNGE AROUND | DAYBED

Designed by Søren Ravn Christensen

MULTIFUNCTIONAL AND FLEXIBLE

Lounge Around daybed is multifunctional and flexible, designed to be the centrepiece of your living room; the perfect place to lie back, relax and recharge.

Available with additional features including a light stand, magazine rack and a table, its simple form and economical depth make it ideal for compact living.

With the Lounge Around accessories you can add extra functionality. Add the Round Table, so you have an extra side table close by, for your laptop or a cup of tea. The Side Pocket offers storage for your weekly newspapers and magazines. Enhance the ambiance by the Lounge Around with the Light Around lamp.

All accessories for the Lounge Around can be modulated and placed exactly where you need it, by using the holes in the back and on the sides of the daybed. When the holes are not used for the Lounge Around accessories, they can be covered by brass brackets included when buying Lounge Around daybed.



COLOUR VARIATIONS



oak



dark oak



TESTS & CERTIFICATIONS

EU: Passed EN 16139 (L1) / EN 1022



DIMENSIONS (H x W x D)

40.3 x 231.6 x 74.5 cm / 15.9 x 91.2 x 29.3"



Flip 180°

Reversible cushion with a thin tray on the reverse side



MATERIAL & UPHOLSTERY

Solid oak, MDF, Steel (plated brass). Polyester in slate grey / dark grey (Marbella). Find more information in the Marbella fabric spec sheet page 256.



CONSTRUCTION

Frame: Solid oak, MDF and steel (plated brass). Tongue and groove, mortise and tenon, dowel joinery. Reinforced with glue and screws. Clear top coat wood finish. **Seat cushion:** Loose. Core of 38 kg 170 Newton foam, top filling 30% feathers and 70% airblown polyester ball fiber.



WEIGHT INCL. PACKAGING

Box 1: 38.5 kg / 15.2"

Box 2: 12.8 kg / 5"



PACKAGING DIMENSIONS (L x W x H)

Box 1: 90 x 137 x 17 cm / 35.4 x 54 x 7"

Box 2: 74 x 78 x 41 cm / 29.5 x 31 x 16"



ASSEMBLY TIME

30 min - video guide at umage.com



MEDIA KIT

Photos and press material

Download at umagepress.com

ORDERING INFORMATION

Oak EU/APAC #5550+5550-1

US #5550+5560-1

UK #5550+5551-1



Dark oak

EU/APAC #5750+5550-1

US #5750+5560-1

UK #5750+5551-1

RECOMMENDED ACCS.

Light Around white

EU/UK/APAC #5400 US #5408

Light Around black

EU/UK/APAC #5401 US #5409

Side Pocket

EU/UK/US/APAC #5402

Round Table oak

EU/UK/US/APAC #5403

Round Table dark oak

EU/UK/US/APAC #5404

Lean Back

EU/APAC #5405 UK #5406 US #5407

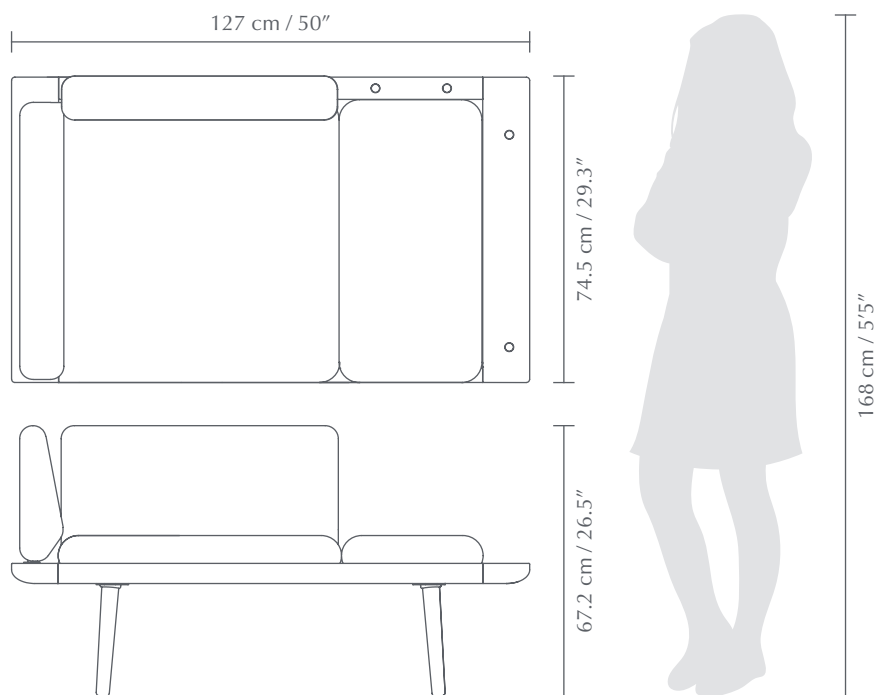

LOUNGE AROUND | 1.5-SEATER

Designed by Søren Ravn Christensen

THE SPACIOUS EGO CHAIR

Lounge Around is a multifunctional, flexible sofa designed to be the centrepiece of your living room. After a busy day it's the perfect place to lie back, relax and recharge.

Clean lines, an unfussy design and high-quality materials give Lounge Around a light Nordic expression. Lounge Around is available with additional features including a light stand, magazine rack and small side table. The narrow seat cushion has a thin tray on the reverse side, allowing you to set aside your coffee or laptop.

Find more inspiration at page 59



TESTS & CERTIFICATIONS

EU: Passed EN 16139 (L1) / EN 1022



DIMENSIONS

H x W x D: 40.3 x 127 x 74.5 cm / 15.9 x 50 x 29.3"



Flip 180°

Reversible cushion with a thin tray on the reverse side



MATERIAL & UPHOLSTERY

Solid oak, MDF, Steel (plated brass). Polyester in slate grey / dark grey (Marbella). Find more information in the Marbella fabric spec sheet page 256.



CONSTRUCTION

Frame: Solid oak, MDF and steel (plated brass). Tongue and groove, mortise and tenon, dowel joinery. Reinforced with glue and screws. Clear top coat wood finish. **Backrest:** Loose. Steel frame with 38 kg 170 Newton foam. **Seat cushion:** Loose. Core of 38 kg 170 Newton foam, top filling 30% feathers and 70% airblown polyester ball fiber. **Back cushion:** Loose. Airblown polyester ball fiber.



WEIGHT INCL. PACKAGING

Box 1: 38.5 kg / 84.9 lb

Box 2: 12.8 kg / 28.2 lb



PACKAGING DIMENSIONS (L x W x H)

Box 1: 82 x 145 x 10 cm / 32.3 x 57.1 x 3.9"

Box 2: 74 x 95 x 41 cm / 29.1 x 37.4 x 16.1"



ASSEMBLY TIME

20 min - video guide at umage.com



MEDIA KIT

Photos and press material

Download at umagepress.com



ORDERING INFORMATION

Oak EU/US/APAC #5562+5562-1
UK #5562+5563-1

Dark oak EU/US/APAC #5762+5562-1
UK #5762+5563-1

RECOMMENDED ACCS.

Light Around white EU/UK/APAC #5400 US #5408

Light Around black EU/UK/APAC #5401 US #5409

Side Pocket EU/UK/US/APAC #5402

Round Table oak EU/UK/US/APAC #5403

Round Table dark oak EU/UK/US/APAC #5404

Lean Back EU/APAC #5405 UK #5406 US #5407

COLOUR VARIATIONS



oak



dark oak

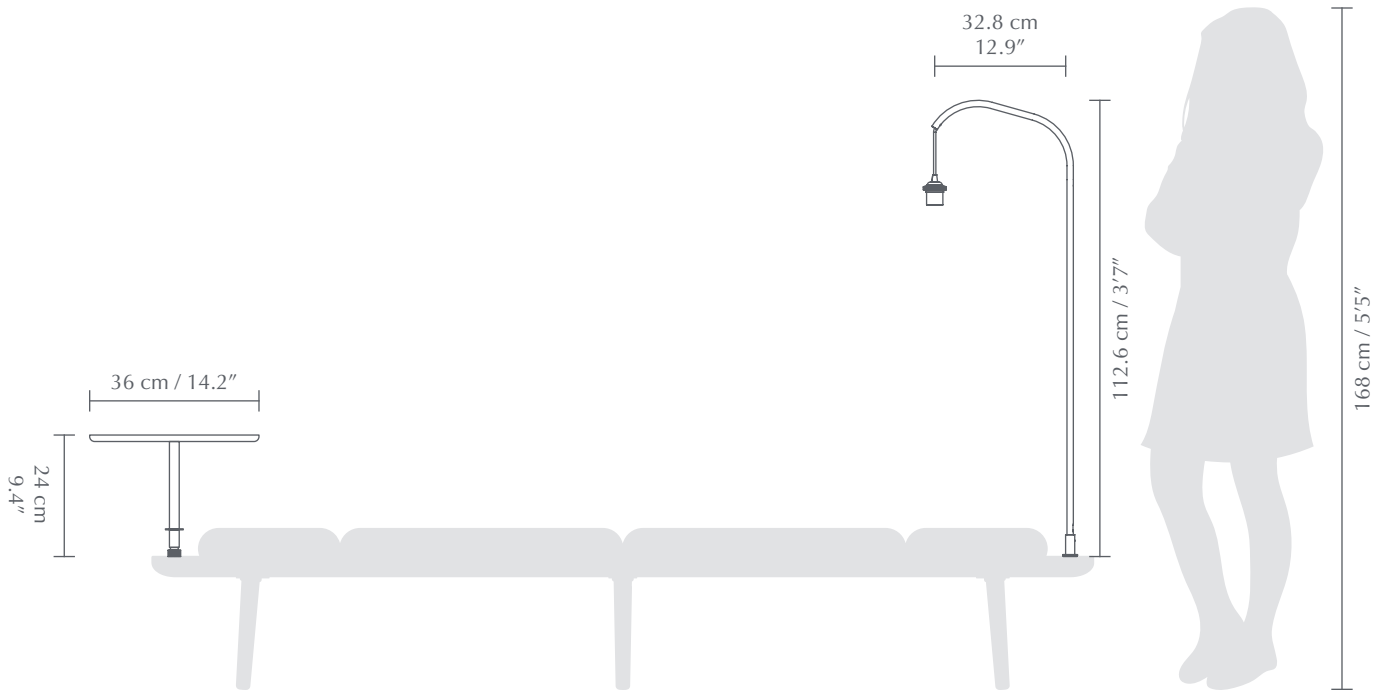

LIGHT AROUND | SOFA ACCESSORY

Designed by Søren Ravn Christensen

ACCESSORIZE YOUR LOUNGE AROUND

With the Lounge Around accessories you can add extra functionality to the Lounge Around sofa and daybed. Add the Round Table, so you have an extra side table close by, for your laptop or a cup of tea. The Side Pocket offers storage for your weekly newspapers and magazines. Enhance the ambiance by the Lounge Around with the Light Around lamp.

All accessories for the Lounge Around can be modulated and placed exactly where you need it, by using the holes in the back and on the sides of the sofa and daybed. When the holes are not used for the Lounge Around accessories, they can be covered by brass brackets included when buying Lounge Around.

Find more inspiration at page 46



TESTS & CERTIFICATIONS

CE (for indoor use), IP2X, cULus certified



DIMENSIONS

D: 32.8 cm / 14"
H: 112.6 cm / 57"



MATERIAL

Aluminium and Steel (plated brass)
Incl. 2 m / 78.7" black textile cord



WEIGHT INCL. PACKAGING

1.2 kg / 2.6 lb



LIGHT SOURCE

E26 / E27 - max 15W LED (not included)



PACKAGING DIMENSIONS (W x H x D)

26 x 105 x 6 cm / 10.2 x 41.3 x 2.4"



ASSEMBLY TIME

3 min - video guide at umage.com



MEDIA KIT

Photos and press material
Download at umagepress.com



ORDERING INFORMATION

Light Around white EU/UK/APAC #5400 / US #5408
Light Around black EU/UK/APAC #5401 / US #5409

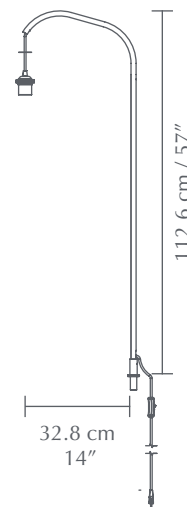
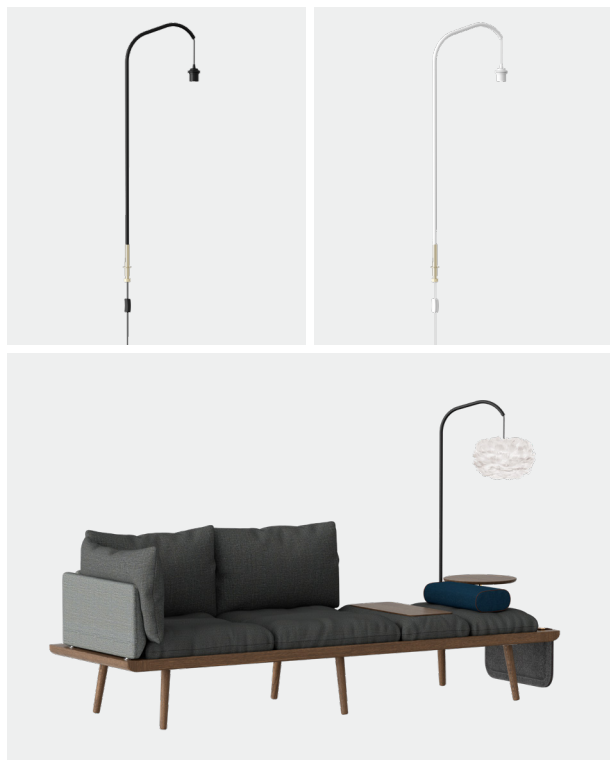

COLOUR VARIATIONS



white



black

SIDE POCKET | SOFA ACCESSORY

Designed by Søren Ravn Christensen

ACCESSORIZE YOUR LOUNGE AROUND

With the Lounge Around accessories you can add extra functionality to the Lounge Around sofa and daybed. Add the Round Table, so you have an extra side table close by, for your laptop or a cup of tea. The Side Pocket offers storage for your weekly newspapers and magazines. Enhance the ambiance by the Lounge Around with the Light Around lamp.

All accessories for the Lounge Around can be modulated and placed exactly where you need it, by using the holes in the back and on the sides of the sofa and daybed. When the holes are not used for the Lounge Around accessories, they can be covered by brass brackets included when buying Lounge Around.



DIMENSIONS

H x W x D: 24 x 57 x 3 cm / 4 x 18 x 8"



MATERIAL

Anthracite grey felt, Leather (faux leather) and Steel



WEIGHT INCL. PACKAGING

600 g / 1.3 lb



PACKAGING DIMENSIONS (L x W x H)

80 x 53 x 26 cm / 31.5 x 20.9 x 10.2"



MEDIA KIT

Photos and press material
Download at umagepress.com



ORDERING INFORMATION

Side Pocket

EU/UK/US #5402

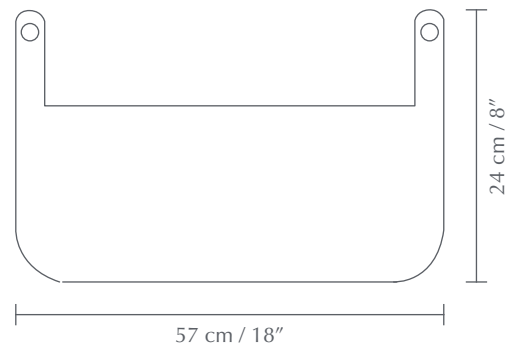

COLOUR VARIATIONS



grey

ROUND TABLE | SOFA ACCESSORY

Designed by Søren Ravn Christensen

ACCESSORIZE YOUR LOUNGE AROUND

With the Lounge Around accessories you can add extra functionality to the Lounge Around sofa and daybed. Add the Round Table, so you have an extra side table close by, for your laptop or a cup of tea. The Side Pocket offers storage for your weekly newspapers and magazines. Enhance the ambiance by the Lounge Around with the Light Around lamp.

All accessories for the Lounge Around can be modulated and placed exactly where you need it, by using the holes in the back and on the sides of the sofa and daybed. When the holes are not used for the Lounge Around accessories, they can be covered by brass brackets included when buying Lounge Around.

Find more inspiration at page 39, 46, 92



DIMENSIONS

Ø: 36 cm / 14"
H: 24 cm / 9.4"



MATERIAL

Laminated veneer and Steel



WEIGHT INCL. PACKAGING

2.5 kg / 5.5 lb



PACKAGING DIMENSIONS (L x W x H)

47 x 11 x 5 cm / 18.5 x 4.3 x 2"



ASSEMBLY TIME

5 min - video guide at umage.com



MEDIA KIT

Photos and press material
Download at umagepress.com



ORDERING INFORMATION

Round Table oak EU/UK/US/APAC #5403
Round Table dark oak EU/UK/US/APAC #5404

COLOUR VARIATIONS



oak



dark oak

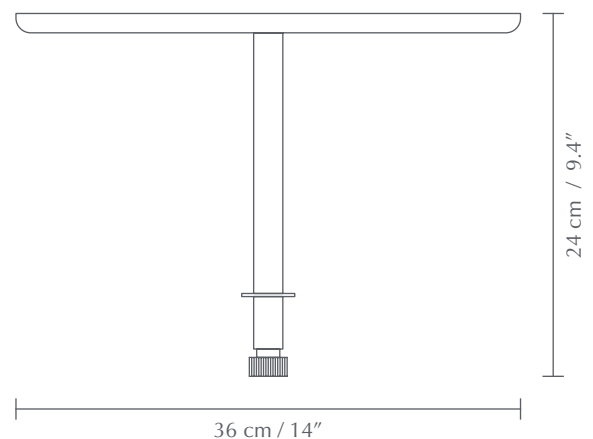



LEAN BACK | SOFA ACCESSORY

Designed by Søren Ravn Christensen

ACCESSORIZE YOUR LOUNGE AROUND

With the Lounge Around accessories you can add extra functionality to the Lounge Around sofa and daybed. Add the Round Table, so you have an extra side table close by, for your laptop or a cup of tea. The Side Pocket offers storage for your weekly newspapers and magazines. Enhance the ambiance by the Lounge Around with the Light Around lamp.

All accessories for the Lounge Around can be modulated and placed exactly where you need it, by using the holes in the back and on the sides of the sofa and daybed. When the holes are not used for the Lounge Around accessories, they can be covered by brass brackets included when buying Lounge Around.



DIMENSIONS

Backrest (H x W x D): 38 x 67 x 11 cm / 13 x 27 x 5"
Back pillow (H x W x D): 53 x 75 x 16 cm / 18 x 28 x 8"



MATERIAL & UPHOLSTERY

Steel and Slate grey / dark grey polyester (Marbella).
Find more information in the Marbella fabric spec sheet page 256.



CONSTRUCTION

Backrest: Steel frame with 38 kg 170 Newton foam.
Black powder coated steel.
Back cushion: Airblown polyester ball fiber.



WEIGHT INCL. PACKAGING

7.5 kg / 16.5 lb



PACKAGING DIMENSIONS (L x W x H):

76.6 x 59.6 x 25.8 cm x 30.2 x 23.5 x 10.2"



MEDIA KIT

Photos and press material
Download at umagepress.com



ORDERING INFORMATION

Lean Back

EU #5405
US #5407
UK #5406

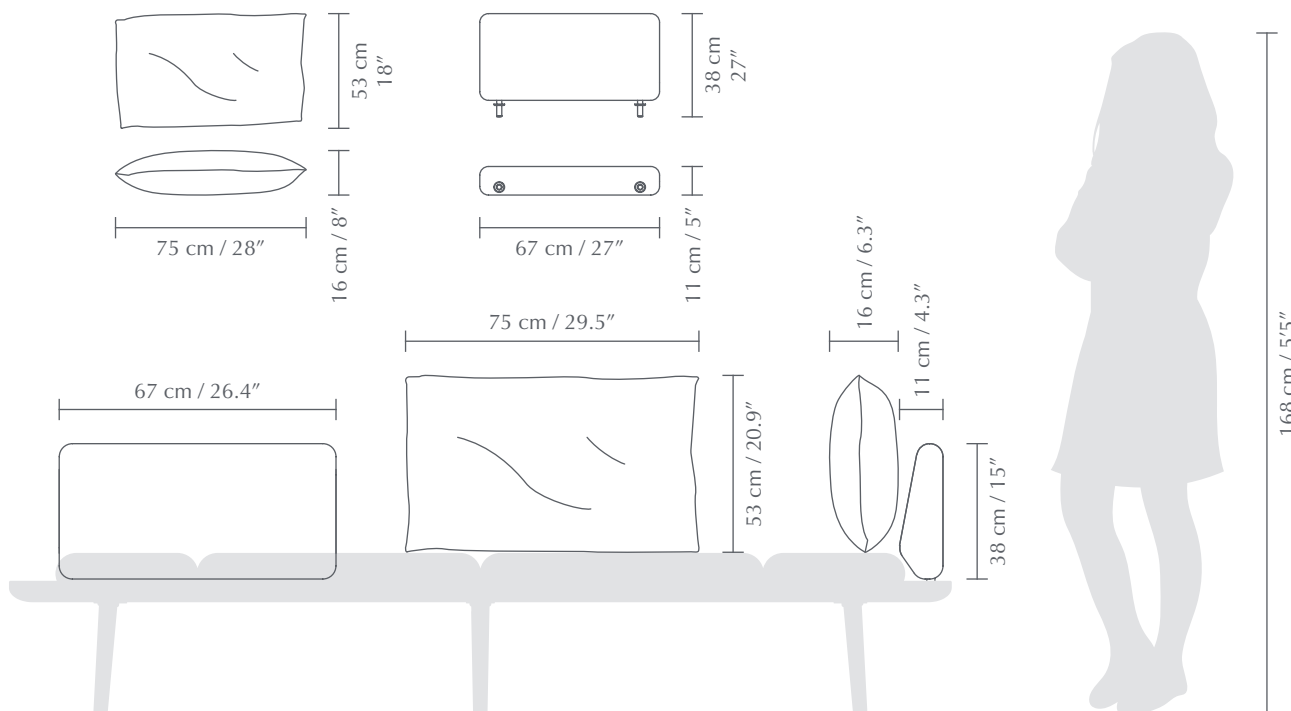

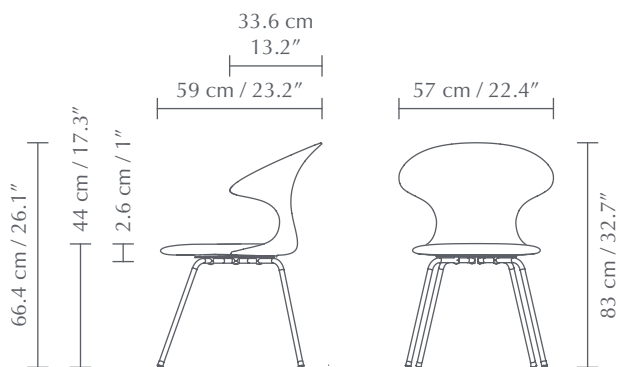

Colour variations

(legs)



(seat)



(back)



TIME FLIES | CHAIR

Designed by Jonas Søndergaard

A CUSTOMISABLE CHAIR WITH A SUSTAINABLE EDGE

The upholstered chair is customisable and provides the flexibility of changing the upholstery yourself, so you can change the visual style without having to buy a new chair, securing a sustainable life of the design.

The chair secures comfort from all sitting positions making the time fly during dinner with friends – hence the name Time Flies™. Your ergonomic sitting position typically changes as the evening evolves: From sitting straight as you eat your dinner, to leaning your back more casually later in the evening, or turning your body as you go into a deep conversation with the person sitting next to you. The chair is designed with a top rail easing into armrests, securing a soft and steady back support from all angles, leaving space for your legs underneath the armrests as you turn your body during the evening.

You can choose from six carefully selected bespoke fabrics including velvet, leather and various woven textiles. Choose to go for one colour or mix and match the colours for the seat and backrest, making the style of the chair flexible and durable over time. The legs will be available in chrome, brass and black extending the flexibility even further.

Find more inspiration at page 14, 19, 24, 31, 57, 63, 74



TESTS & CERTIFICATIONS

EU: Passed EN 16139 (L1) / EN 1022



DIMENSIONS

H x W x D: 83 x 57 x 59 cm / 32.6 x 22.4 x 23"



MATERIAL

Fabric / leather and steel

Find more information in the fabric spec sheet



CONSTRUCTION

Backrest: Inner steel construction surrounded by casted PU foam. **Seat cushion:** Plywood with PU foam.



WEIGHT INCL. PACKAGING

Box 1: 25.5 kg / 52.2 lb

Box 2: 18.7 kg / 41.2 lb

Box 3: 450 g / 15.9 oz

Box 4: 700 g / 24.7 oz



PACKAGING DIMENSIONS

Box 1 (L x W x H): 60 x 47 x 47 cm / 23.6 x 18.5 x 18.5"

Box 2 (L x W x H): 57 x 18 x 51 cm / 22.4 x 7.1 x 20.1"

Box 3 (L x W x H): 53 x 49 x 1.5 cm / 20.9 x 19.3 x 0.6"

Box 4 (L x W x H): 61 x 49 x 3 cm / 24 x 19.3 x 1.2"



ASSEMBLY TIME

30 min - video guide at umage.com



MEDIA KIT

Photos and press material

Download at umagepress.com



ORDERING INFORMATION

Time Flies (legs) brass

Time Flies (legs) chrome

Time Flies (legs) black

Time Flies (seat) rusty brown

Time Flies (seat) forest green

Time Flies (seat) pale rose

Time Flies (seat) canary yellow

Time Flies (seat) tweed

Time Flies (seat) silver grey

Time Flies (seat) slate grey

Time Flies (seat) sand

Time Flies (seat) teddy white

Time Flies (back) rusty brown

Time Flies (back) forest green

Time Flies (back) pale rose

Time Flies (back) canary yellow

Time Flies (back) tweed / hazelnut (faux leather)

Time Flies (back) silver grey / wellington

Time Flies (back) silver grey

Time Flies (back) slate grey

Time Flies (back) sand

Time Flies (back) sand / burnt almond (faux leather)

Time Flies (back) teddy white

EU/APAC #5900-1+5901-1 / UK #5904-1+5901-1 / US #5907-1+5901-1

EU/APAC #5900-1+5901-2 / UK #5904-1+5901-2 / US #5907-1+5901-2

EU/APAC #5900-1+5901-3 / UK #5904-1+5901-3 / US #5907-1+5901-3

EU/APAC #5902-1 / UK/US #5908-1

EU/APAC #5902-2 / UK/US #5908-2

EU/APAC #5902-3 / UK/US #5908-3

EU/APAC #5902-4 / UK/US #5908-4

EU/APAC #5902-8 / UK/US #5908-8

EU/APAC #5902-9 / UK/US #5908-9

EU/APAC #5910-1 / UK/US N/A

EU/APAC #5910-2 / UK/US N/A

EU/APAC #5910-3 / UK/US N/A

EU/APAC #5903-1 / UK/US #5909-1

EU/APAC #5903-2 / UK/US #5909-2

EU/APAC #5903-3 / UK/US #5909-3

EU/APAC #5903-4 / UK/US #5909-4

EU/APAC #5903-6 / UK/US #5909-6

EU/APAC #5903-7 / UK/US #5909-7

EU/APAC #5903-8 / UK/US N/A

EU/APAC #5903-9 / UK/US N/A

EU/APAC #5911-1 / UK/US N/A

EU/APAC #5911-2 / UK/US N/A

EU/APAC #5911-3 / UK/US N/A

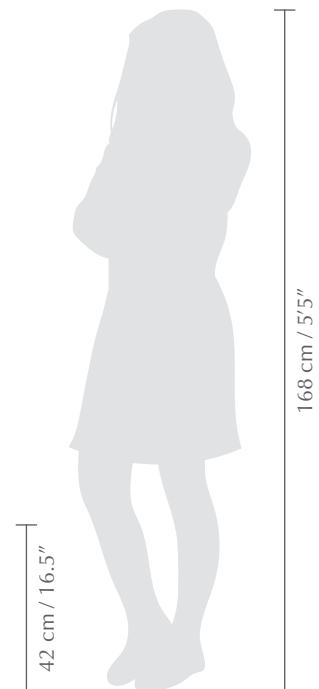
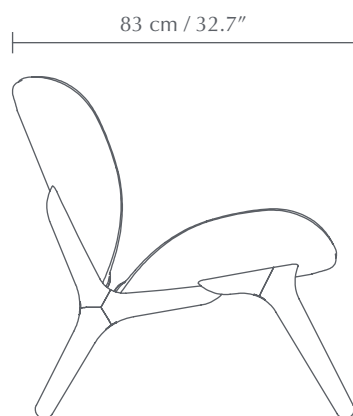
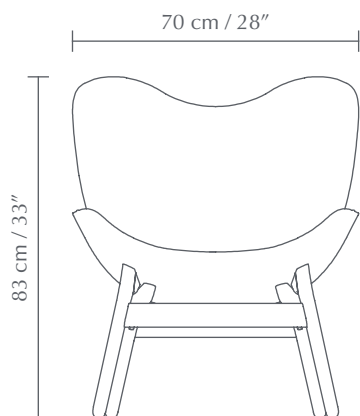

A CONVERSATION PIECE LOW | LOUNGE CHAIR

Designed by Anders Klem

RELAXATION AND OPENNESS

A Conversation Piece™ low is a lounge chair that encourages relaxation and openness, unwinding and having a conversation with friends. It is ideal for use in the living room, as a corner chair or as part of an extra lounge area. Its comfortable shape also makes it suitable for the bedroom or as an extra chair in a nursery.

Find more inspiration at page 28, 45, 48, 53, 59, 93

#

ORDERING INFORMATION

Oak:
 Petrol blue EU/US/APAC #5501+5501-1 / UK #5501+5503-1
 Silver grey EU/US/APAC #5501+5501-2 / UK #5501+5503-2
 Spring green* EU/US/APAC #5507 / UK N/A
 Dusty rose* EU/US/APAC #5508 / UK #5501+5503-4
 Slate grey EU/US/APAC #5501+5501-5 / UK #5501+5503-5
 Teddy white EU/APAC #5501+5501-7 / UK/US N/A

Dark oak:
 Petrol blue EU/US/APAC #5700+5501-1 / UK #5700+5503-1
 Silver grey EU/US/APAC #5700+5501-2 / UK #5700+5503-2
 Spring green* EU/US/APAC #5706 / UK N/A
 Dusty rose* EU/US/APAC #5707 / UK #5700+5503-4
 Slate grey* EU/US/APAC #5708 / UK #5700+5503-5
 Teddy white EU/APAC #5700+5501-7 / UK/US N/A
 Sand EU #5716 / US/UK N/A
 Brown EU #5717 / US/UK N/A
 Cream EU #5718 / US/UK N/A

Black oak:
 Petrol blue EU/US/APAC #5102+5501-1 / UK #5102+5503-1
 Silver grey EU/US/APAC #5102+5501-2 / UK #5102+5503-2
 Spring green EU/US/APAC #5102+5501-3 / UK N/A
 Dusty rose EU/US/APAC #5102+5501-4 / UK #5102+5503-4
 Slate grey EU/US/APAC #5102+5501-5 / UK #5102+5503-5
 Teddy white EU/APAC #5102+5501-7 / UK/US N/A

*Product currently delivered in 1 box will be switched to 2 boxes when existing stock is over. Please check current status with UIMAGE.

Colour variations (Fabrics from Kvadrat & Sorensen Leather available on request, find more info in the Upholstery spec. sheets)



oak dark oak black oak

(wood)

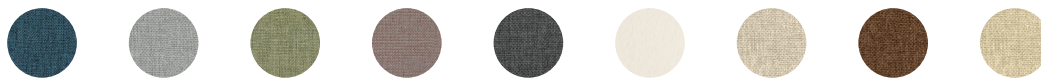

petrol blue silver grey spring green dusty rose slate grey teddy white sand brown cream

(fabric)



DIMENSIONS

H x W x D: 83 x 70 x 83 cm / 33 x 28 x 33"



TESTS & CERTIFICATIONS

EU: Passed EN 16139 (L1) / EN 1022
 US: Passed ANSI/BIFMA X5.4



MATERIAL

Solid oak, Laminated veneer and Polyester (Kingston). Find more information in the Kingston fabric spec sheet. Also available in Kvadrat fabrics or Sorensen Leather.



WEIGHT INCL. PACKAGING

Box 1: 17 kg / 37 lb
 Box 2: 9.5 kg / 20 lb



PACKAGING

Box dimensions (L x W x H):
 Box 1 (L x W x H): 61 x 74 x 68.4 cm / 24 x 29 x 27"
 Box 2 (L x W x H): 74 x 61.4 x 30.5 cm / 29 x 24 x 12"



ASSEMBLY TIME

20 min - video guide at umage.com



MEDIA KIT

Photos and press material
 Download at umagepress.com



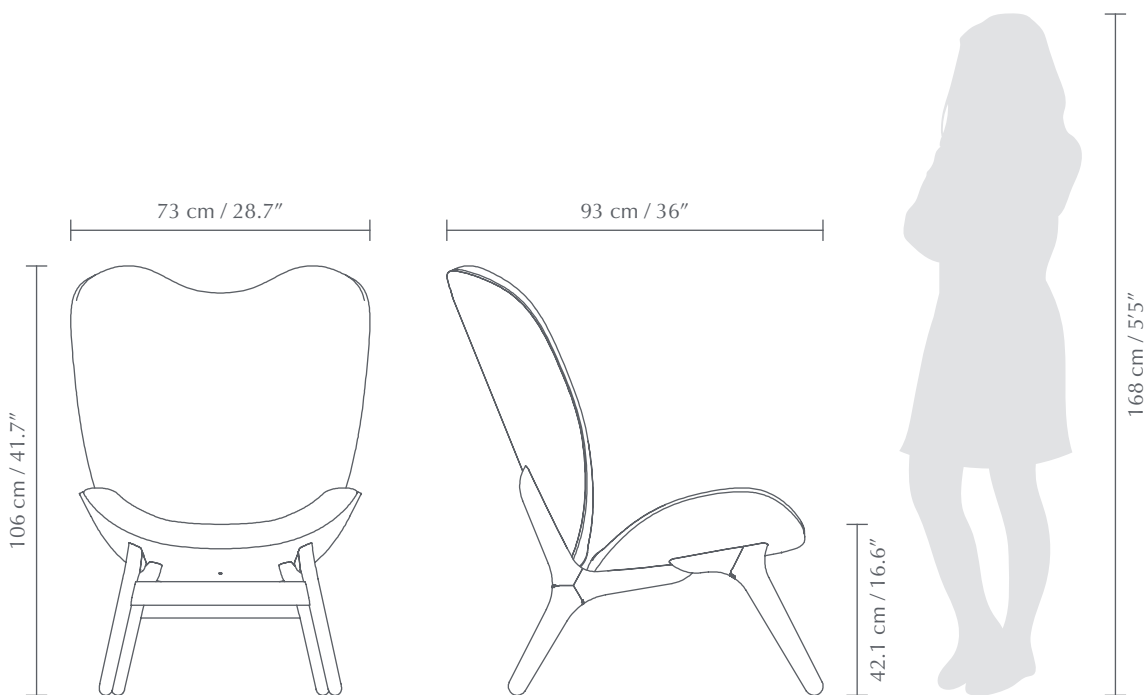

A CONVERSATION PIECE TALL | LOUNGE CHAIR

Designed by Anders Klem

FEEL SHELTERED

A Conversation Piece™ tall is a standout design piece with a spacious seat that has plenty of room for sitting in different positions, whether curled up with your legs or fully stretched out, and the tall back of the chair catches your head at any angle, for you to feel sheltered.

Find more inspiration at page 27, 89, 94



ORDERING INFORMATION

Oak:

Petrol blue	EU/US/APAC #5577+5577-1 / UK N/A
Silver grey	EU/US/APAC #5577+5577-2 / UK N/A
Spring green	EU/US/APAC #5577+5577-3 / UK N/A
Dusty rose	EU/US/APAC #5577+5577-4 / UK N/A
Slate grey	EU/US/APAC #5577+5577-5 / UK N/A
Teddy white	EU/APAC #5577+5577-6 / US/UK N/A

Dark oak:

Petrol blue	EU/US/APAC #5872+5577-1 / UK N/A
Silver grey	EU/US/APAC #5872+5577-2 / UK N/A
Spring green	EU/US/APAC #5872+5577-3 / UK N/A
Dusty rose	EU/US/APAC #5872+5577-4 / UK N/A
Slate grey	EU/US/APAC #5872+5577-5 / UK N/A
Teddy white	EU/APAC #5872+5577-6 / US/UK N/A

Black oak:

Petrol blue	EU/US/APAC #5104+5577-1 / UK N/A
Silver grey	EU/US/APAC #5104+5577-2 / UK N/A
Spring green	EU/US/APAC #5104+5577-3 / UK N/A
Dusty rose	EU/US/APAC #5104+5577-4 / UK N/A
Slate grey	EU/US/APAC #5104+5577-5 / UK N/A
Teddy white	EU/APAC #5104+5577-6 / US/UK N/A



DIMENSIONS

H x W x D: 106 x 73 x 93 cm / 41.7 x 28.7 x 36"



TESTS & CERTIFICATIONS

EU: Passed EN 16139 (L1)
US: Passed ANSI/BIFMA X5.4



MATERIAL

Solid oak, Plywood, Polyester (Kingston), MDF and PUR. Find more information in the Kingston fabric spec sheet. Also available in Kvadrat fabrics or Sorensen Leather.



WEIGHT INCL. PACKAGING

Box 1: 22 kg / 48.5 lb
Box 2: 16 kg / 35.3 lb



PACKAGING

Box dimensions (L x W x H):
Box 1 (L x W x H):
76.6 x 84.6 x 71.9 cm / 30.2 x 33.3 x 28.3"
Box 2 (L x W x H):
77.4 x 85.9 x 31.3 cm / 30.5 x 33.8 x 12.3"



ASSEMBLY TIME

20 min - video guide at umage.com



MEDIA KIT

Photos and press material
Download at umagepress.com

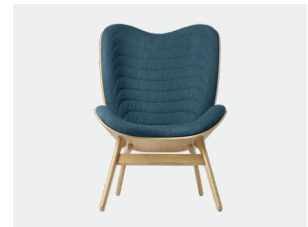

Colour variations (Fabrics from Kvadrat & Sorensen Leather available on request, find more info in the Upholstery spec. sheets)



oak



dark oak



black oak



petrol blue



silver grey



spring green



dusty rose



slate grey



teddy white



50 cm / 19.7"

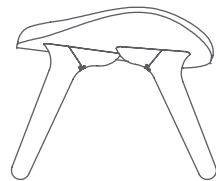

63 cm / 24.8"

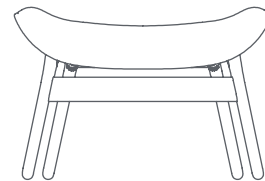

43 cm / 16.9"



168 cm / 5'5"

A CONVERSATION PIECE | OTTOMAN

Designed by Anders Klem

LET YOUR FEET UNWIND

A Conversation Piece™ ottoman is designed for you to have a safe spot to recharge and relax your entire body – including the feet. The ottoman complement the delicate heart-shaped silhouette of the lounge and has the same organic design and detailed construction of no visible fittings that is known and loved from the lounge chairs.



DIMENSIONS

H x W x D: 43 x 63 x 50 cm / 16.9 x 24.8 x 19.7"



TESTS & CERTIFICATIONS

EU: Passed EN 16139 (L1)
US: Passed ANSI/BIFMA X5.4



MATERIAL

Solid oak, Plywood, Polyester (Kingston), MDF and PUR. Find more information in the Kingston fabric spec sheet. Also available in Kvadrat fabrics or Sorensen Leather.



WEIGHT INCL. PACKAGING

Box 1: 13 kg / 28.7 lb
Box 2: 6 kg / 13.2 lb



PACKAGING

Box dimensions (L x W x H):
Box 1 (L x W x H):
51.8 x 67.3 x 30.9 cm / 20.4 x 26.5 x 12.2"
Box 2 (L x W x H):
53.4 x 67.9 x 17.7 cm / 21 x 26.7 x 7"



ASSEMBLY TIME

15 min - video guide at umage.com



MEDIA KIT

Photos and press material
Download at umagepress.com



ORDERING INFORMATION

Oak:

Petrol blue	EU/US/APAC #5573+5573-1 / UK N/A
Silver grey	EU/US/APAC #5573+5573-2 / UK N/A
Spring green	EU/US/APAC #5573+5573-3 / UK N/A
Dusty rose	EU/US/APAC #5573+5573-4 / UK N/A
Slate grey	EU/US/APAC #5573+5573-5 / UK N/A
Teddy white	EU/APAC #5573+5573-6 / UK/US N/A

Dark oak:

Petrol blue	EU/US/APAC #5873+5573-1 / UK N/A
Silver grey	EU/US/APAC #5873+5573-2 / UK N/A
Spring green	EU/US/APAC #5873+5573-3 / UK N/A
Dusty rose	EU/US/APAC #5873+5573-4 / UK N/A
Slate grey	EU/US/APAC #5873+5573-5 / UK N/A
Teddy white	EU/APAC #5872+5573-6 / UK/US N/A

Black oak:

Petrol blue	EU/US/APAC #5105+5573-1 / UK N/A
Silver grey	EU/US/APAC #5105+5573-2 / UK N/A
Spring green	EU/US/APAC #5105+5573-3 / UK N/A
Dusty rose	EU/US/APAC #5105+5573-4 / UK N/A
Slate grey	EU/US/APAC #5105+5573-5 / UK N/A
Teddy white	EU/APAC #5105+5573-6 / UK/US N/A



Colour variations (Fabrics from Kvadrat & Sorensen Leather available on request, find more info in the Upholstery spec. sheets)



oak



dark oak



black oak



petrol blue



silver grey



spring green



dusty rose



slate grey



teddy white

NEW

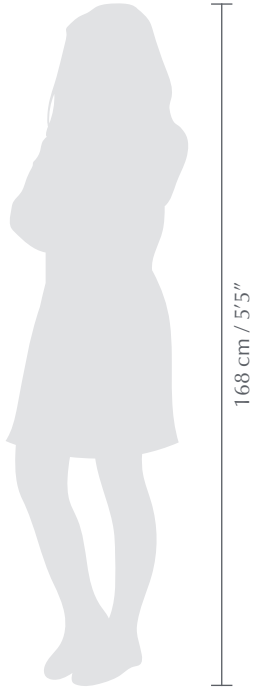
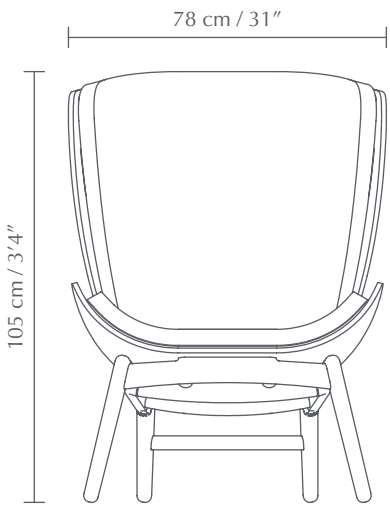

THE READER | WING CHAIR

Designed by Tor Hadsund

SHELL YOURSELF FROM THE OUTSIDE AND DIVE IN

The Reader wing chair has been designed as a place for letting your body sink into and relax. The chair's special curved shell is inspired by traditional Danish crafting techniques and helps to reduce surrounding noise, offering a place of shelter and reflection.

With its light form and bold organic curves, The Reader is a stand-out design piece in any setting and just right for enjoying a good book or engaging conversation.

Find more inspiration at page 40, 43, 45, 47, 56, 57, 58, 61, 95, 98

#

ORDERING INFORMATION

Oak:

Petrol blue	EU/US/APAC #5502+5502-1 / UK #5502+5504-1
Silver grey	EU/US/APAC #5502+5502-2 / UK #5502+5504-2
Spring green	EU/US/APAC #5502+5502-3 / UK N/A
Dusty rose	EU/US #5502+5502-4 / UK #5502+5504-4
Slate grey	EU/US/APAC #5502+5502-5 / UK #5502+5504-5
Teddy white	EU/APAC #5502+5502-7 / UK/US N/A

Dark oak:

Petrol blue	EU/US/APAC #5701+5502-1 / UK #5701+5504-1
Silver grey	EU/US/APAC #5701+5502-2 / UK #5701+5504-2
Spring green*	EU/US/APAC #5711 / UK N/A
Dusty rose	EU/US/APAC #5701+5502-4 / UK #5701+5504-4
Slate grey	EU/US/APAC #5701+5502-5 / UK #5701+5504-5
Teddy white	EU/APAC #5701+5502-7 / UK/US N/A

Black oak:

Petrol blue	EU/US/APAC #5103+5502-1 / UK #5103+5504-1
Silver grey	EU/US/APAC #5103+5502-2 / UK #5103+5504-2
Spring green	EU/US/APAC #5103+5502-3 / UK N/A
Dusty rose	EU/US/APAC #5103+5502-4 / UK #5103+5504-4
Slate grey	EU/US/APAC #5103+5502-5 / UK #5103+5504-5
Teddy white	EU/APAC #5103+5502-7 / UK/US N/A

*Product currently delivered in 1 box will be switched to 2 boxes when existing stock is over. Please check current status with UMAGE.



DIMENSIONS

H x W x D: 105 x 78 x 91 cm / 41 x 31 x 36"



TESTS & CERTIFICATIONS

EU: Passed EN 16139 (L1) / EN 1022
US: Passed ANSI/BIFMA X5.4



MATERIAL

Solid oak, Laminated veneer and Polyester (Kingston). Find more information in the Kingston fabric spec sheet. Also available in Kvadrat fabrics or Sorensen Leather.



WEIGHT INCL. PACKAGING

Box 1: 22.5 kg / 49 lb
Box 2: 11.5 kg / 25 lb



PACKAGING

Box 1 (L x W x H): 85.6 x 82 x 56 cm / 34 x 32.3 x 22"
Box 2 (L x W x H): 82.5 x 78 x 24 cm / 32.5 x 31 x 9.5"



ASSEMBLY TIME

20 min - video guide at umage.com



MEDIA KIT

Photos and press material
Download at umagepress.com



Colour variations (Fabrics from Kvadrat & Sorensen Leather available on request, find more info in the Upholstery spec. sheets)



oak



dark oak



black oak



petrol blue



silver grey



spring green



dusty rose



slate grey



teddy white

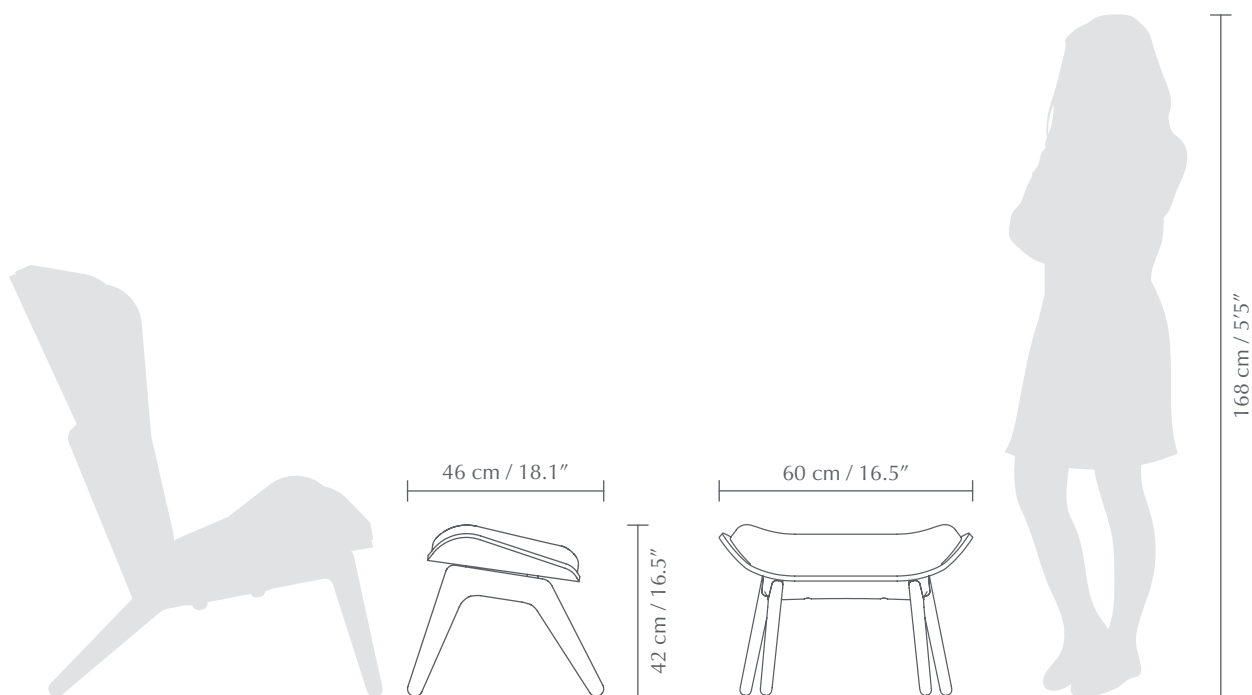

THE READER | OTTOMAN

Designed by Tor Hadsund

INCREASE THE RELAXATION WITH THE OTTOMAN

The solid oak legs on the Ottoman are visually lifted from the base adding a light character to the design.

The shape of the cushions have been designed to slightly expose the Ottoman's shell, giving extra focus on the wooden details.

A palette of Scandinavian colours for the upholstery are carefully selected to endorse the natural wood of the oak. Other fabrics and leathers from Kvadrat and Sorensen leather are available on request.

Find more inspiration at page 40



DIMENSIONS (H x W x D)
42 x 60 x 46 cm / 16.5 x 24 x 18"



MATERIAL & UPHOLSTERY
Solid oak, Laminated veneer and Polyester (Kingston).
Find more information in the Kingston fabric spec sheet page 257.



PACKAGING DIMENSIONS (L x W x H):
52.2 x 46.7 x 9.3 cm / 20.5 x 18.4 x 4"



ASSEMBLY TIME
15 min - video guide at umage.com



MEDIA KIT
Photos and press material
Download at umagepress.com



ORDERING INFORMATION

Oak petrol blue	EU/UK/US/APAC #5583+5583-1
Oak silver grey	EU/UK/US/APAC #5583+5583-2
Oak spring green	EU/UK/US/APAC #5583+5583-3
Oak dusty rose	EU/UK/US/APAC #5583+5583-4
Oak slate grey	EU/UK/US/APAC #5583+5583-5
Dark oak petrol blue	EU/UK/US/APAC #5588+5588-1
Dark oak silver grey	EU/UK/US/APAC #5588+5588-2
Dark oak spring green	EU/UK/US/APAC #5588+5588-3
Dark oak dusty rose	EU/UK/US/APAC #5588+5588-4
Dark oak slate grey	EU/UK/US/APAC #5588+5588-5
Black oak petrol blue	EU/UK/US/APAC #5116+5116-1
Black oak silver grey	EU/UK/US/APAC #5116+5116-2
Black oak spring green	EU/UK/US/APAC #5116+5116-3
Black oak dusty rose	EU/UK/US/APAC #5116+5116-4
Black oak slate grey	EU/UK/US/APAC #5116+5116-5

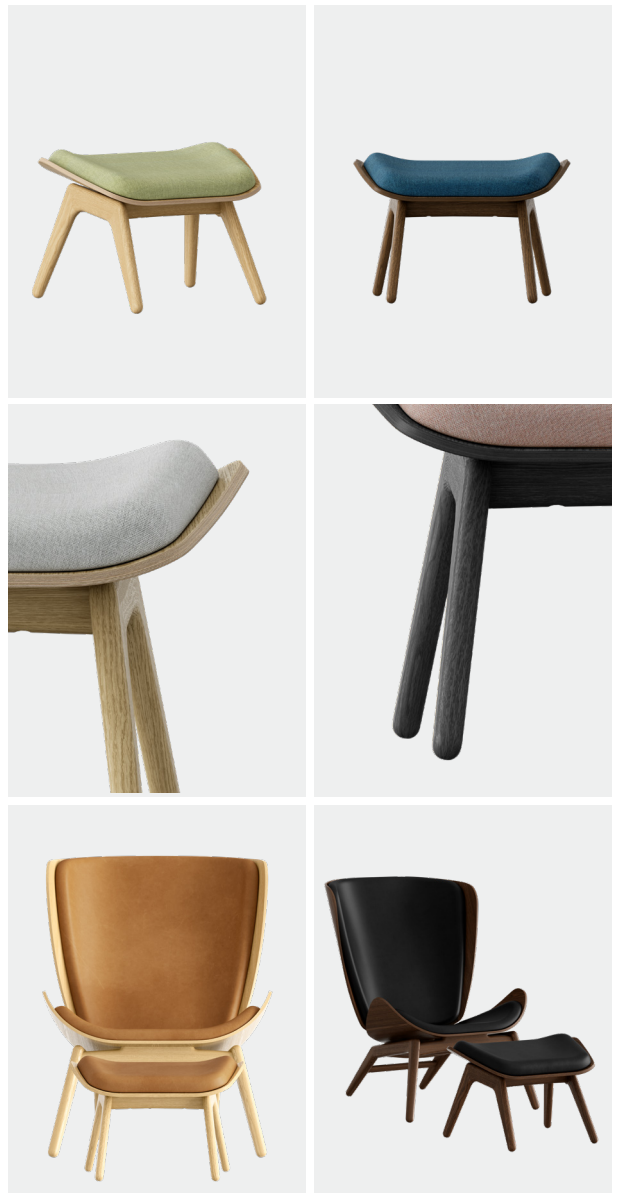

Colour variations (Fabrics from Kvadrat & Sorensen Leather available on request, find more info in the Upholstery spec. sheets)



oak



dark oak



black oak



petrol blue



silver grey



spring green



dusty rose



slate grey

NEW



COMFORT CIRCLE | TABLE

Designed by Søren Ravn Christensen

GATHER AROUND THE TABLE FOR MEMORABLE MOMENTS

Introducing our first-ever dining table; Comfort Circle™, with great attention to detail and strong craftsmanship in the drop-shaped legs with carve grooved details - a tactile detail for the senses.

The Comfort Circle™ dining table has solid oak legs and table top in oak veneer. The round dining table offers a subtle lightness in the room making it perfect for smaller spaces and invites to the intimate conversation with everyone centred towards the middle.

Available in oak, dark oak and black oak with a diameter of 120 cm, just perfect for 4 people. The table is versatile and can highlight private homes as well as public spaces. Equally suitable for intimate meetings and larger café environments.

Find more inspiration at page 38, 74

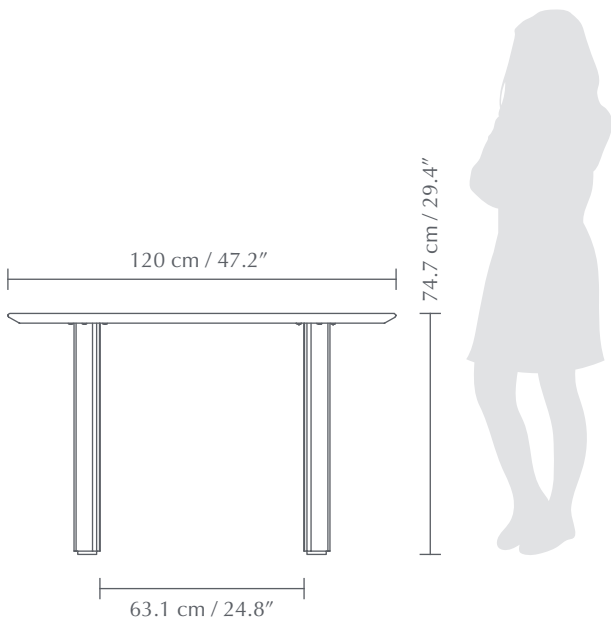

Colour variations



oak



dark oak



black oak



DIMENSIONS

Ø: 120 cm / 47.2"
H: 74.7 cm / 29.4"



MATERIAL

Solid oak, MDF, Leather (faux leather), Polyester, Steel



CONSTRUCTION

Top: Oak and MDF. Clear top coat wood finish.

Legs: Solid oak and steel. Legs attached with bolts.



WEIGHT INCL. PACKAGING

33 kg / 72.8 lb



PACKAGING

Box dimensions (L x W x H):

Box 1 (L x W x H):

128.5 x 128.5 x 9.5 cm / 50.6 x 50.6 x 3.7"

Box 2 (L x W x H):

78.5 x 48.5 x 14 cm / 30.9 x 19.1 x 5.5"



ASSEMBLY TIME

15-20 min - video guide at umage.com



MEDIA KIT

Photos and press material

Download at umagepress.com



ORDERING INFORMATION

Oak

EU/UK/US/APAC #5656+5656-1

Dark oak

EU/UK/US/APAC #5856+5856-1

Black oak

EU/UK/US/APAC #5156+5156-1

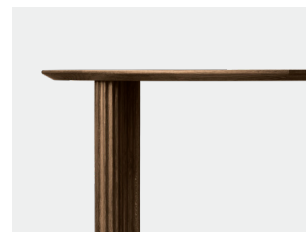



MY SPOT | SIDE TABLE

Designed by Jonas Søndergaard

ALWAYS HAVE YOUR THINGS CLOSE BY WITH MY SPOT

My Spot is a stylish side table ideal for those places in your interior where you need to put things away but still keep them within reach. The side table combines classic clean and minimal Scandinavian design with the modern twist of a builtin multiple USB- charging hub.

My Spot is the perfect height to sit next to your sofa and the table top is the same standard height as a high armchair or high armed sofa.

Find more inspiration at page 34, 45, 51, 59, 81, 83, 92

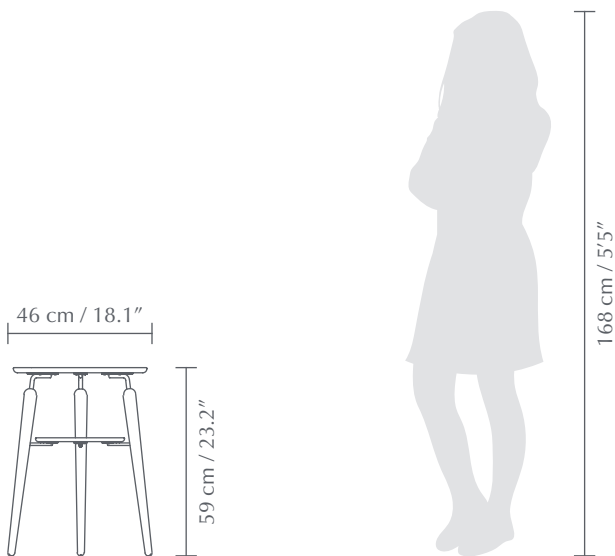

Colour variations



oak
brass



oak
steel



dark oak
brass



black oak
brass



USB-hub incl.



DIMENSIONS

H: 59 x W: 46 x D: 46 cm / H: 23 x W: 18 x D: 18"



MATERIAL

Solid oak, MDF and Steel



CONSTRUCTION

Frame: Solid oak. Clear top coat wood finish.

Legs: Solid oak. Legs attached with bolts and insert

bushings. **Plate:** MDF with American white oak

laminated veneer on sides. **Brackets:** Electroplated steel (brass/steel look).



WEIGHT INCL. PACKAGING

6.5 kg / 14.3 lb



PACKAGING

Box dimensions (L x W x H):

69 x 73 x 7 cm / 27 x 29 x 3"



ASSEMBLY TIME

30 min - video guide at umage.com



MEDIA KIT

Photos and press material

Download at umagepress.com



ORDERING INFORMATION

My Spot oak brass

EU/UK/US/APAC #5571

My Spot oak steel

EU/UK/US/APAC #5580

My Spot dark oak brass

EU/UK/US/APAC #5771

My Spot black oak brass

EU/UK/US/APAC #5115

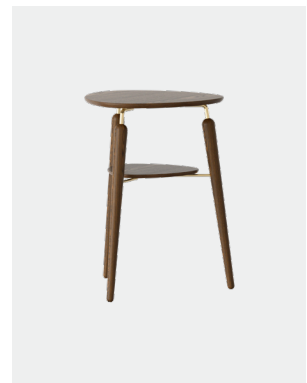

NEW



HANG OUT | COFFEE TABLE

Designed by Jonas Søndergaard

GATHER AROUND, IT'S COFFEE TIME

With its clean and minimal organic shape, as well as the combination of wood and fine metal details, the Hang Out coffee table has a classic Scandinavian expression. Thin graceful legs attached to a slender metal bracket and sculptured rounded table top give Hang Out a light and airy profile.

Underneath the table top, a special bag is suspended across Hang Out's three legs like a hammock. The stylish two-sided leather and textile bag is perfect for storing small items. With both a leather and textile side, Hang Out's bag can be easily swapped around to add a different expression to your interior.

Find more inspiration at page 43, 45, 47, 93

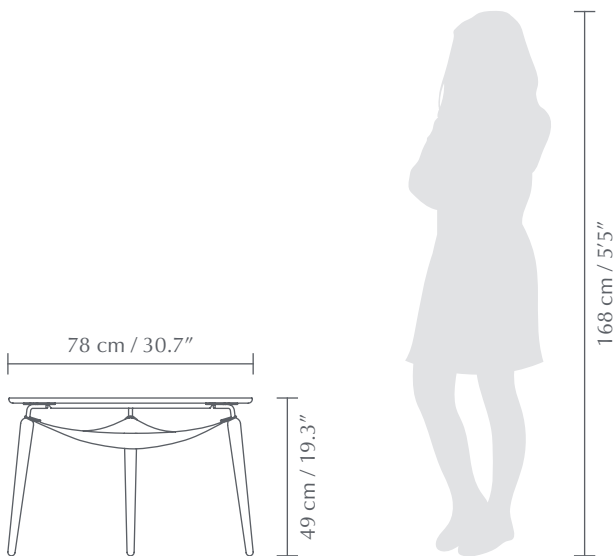

Colour variations



oak
brass



oak
steel



dark oak
brass



black oak
brass



DIMENSIONS

H x W x D: 49 x 78 x 78 cm / 19 x 30 x 29"



MATERIAL

Solid oak, MDF, Leather (faux leather), Polyester and Steel



CONSTRUCTION

Frame: Solid oak. Clear top coat wood finish. **Legs:** Solid oak. Legs attached with bolts and insert bushings.

Plate: MDF with American white oak laminated veneer on sides. **Brackets:** Electroplated steel (brass/steel look).

Hooks for bag: Electroplated steel (brass/steel look).

Fabric: 100% polyester. Moisture barrier added between fabric and filling to prevent moisture penetration. Leather on bag made within the REACH standards.



WEIGHT INCL. PACKAGING

11 kg / 24.3 lb



PACKAGING

Box dimensions (L x W x H):
80 x 98 x 7 cm / 31.5 x 39 x 2.8"



ASSEMBLY TIME

20 min - video guide at umage.com



MEDIA KIT

Photos and press material
Download at umagepress.com



ORDERING INFORMATION

Hang Out oak brass	EU/UK/US/APAC #5570
Hang Out oak steel	EU/UK/US/APAC #5579
Hang Out dark oak brass	EU/UK/US/APAC #5770
Hang Out black oak brass	EU/UK/US/APAC #5114



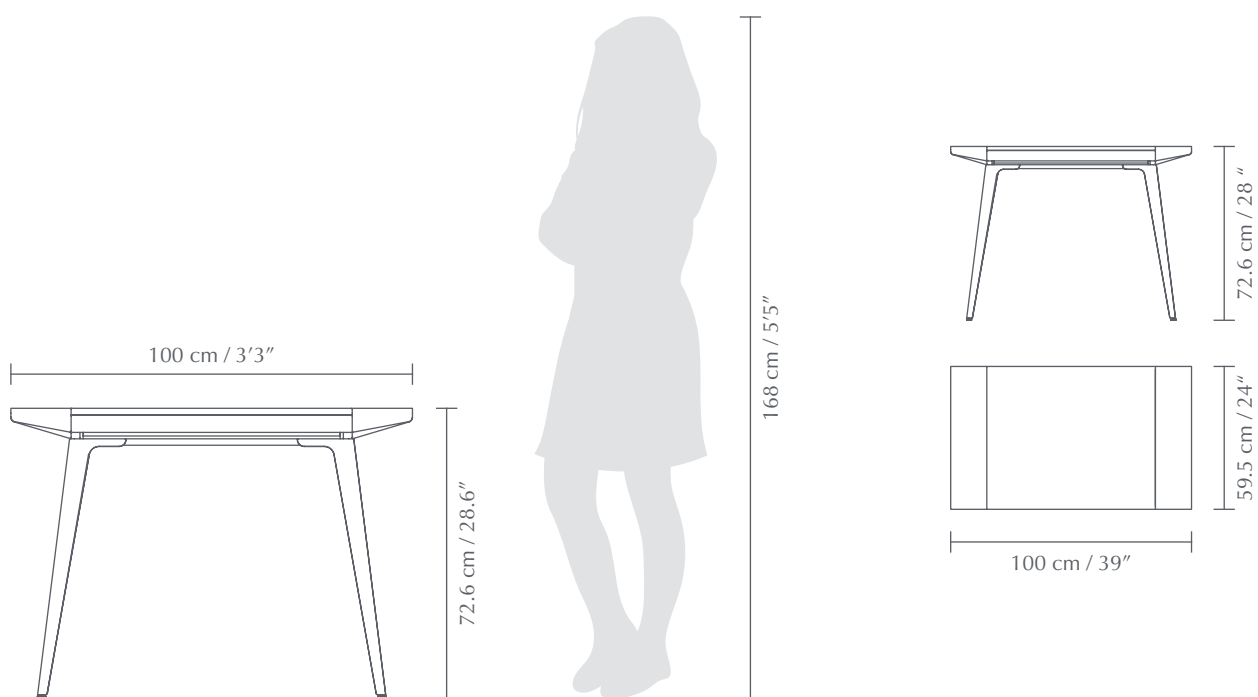

AMBITIONS | DESK

Designed by Jonas Søndergaard

WORK SMARTER NOT HARDER

Ambitions is a compact, yet light and elegant desk designed for making sure your work space stays free from clutter.

Stylish and minimal, Ambitions has been designed with functionality in mind and contains hidden drawers and compartments to keep your wires, papers and other items out of sight.

At just one metre across, the Ambitions desk is able to comfortably fit into smaller living spaces.

Find more inspiration at page 31



TESTS & CERTIFICATIONS

EU: Passed EN 15372



DIMENSIONS

H x W x D: 72.6 x 100 x 59.5 cm / 28 x 39 x 24"



MATERIAL

Solid oak, MDF and Steel



CONSTRUCTION

Top: MDF with oak veneer and solid oak on front and back side. Dowel joinery. Reinforced with glue and screws. Clear top coat wood finish.

Leg covers: White oak laminated veneer.

Steel: Powder coated.



WEIGHT INCL. PACKAGING

Box 1: 24 kg / 53 lb

Box 2: 8 kg / 18 lb



PACKAGING DIMENSIONS (L x W x H)

Box 1: 108.5 x 68 x 15 cm / 43 x 27 x 6"

Box 2: 78.5 x 31.5 x 19 cm / 31 x 12.4 x 7.5"



ASSEMBLY TIME

15 min - video guide at umage.com



MEDIA KIT

Photos and press material

Download at umagepress.com



ORDERING INFORMATION

Ambitions oak EU/UK/US/APAC #5640+5640-1

Ambitions dark oak EU/UK/US/APAC #5840+5840-1

COLOUR VARIATIONS



oak



dark oak

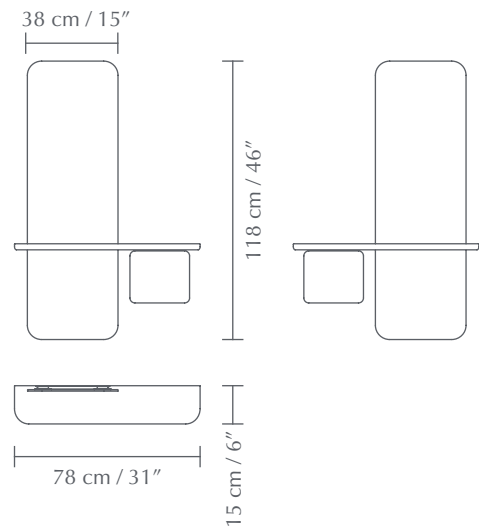
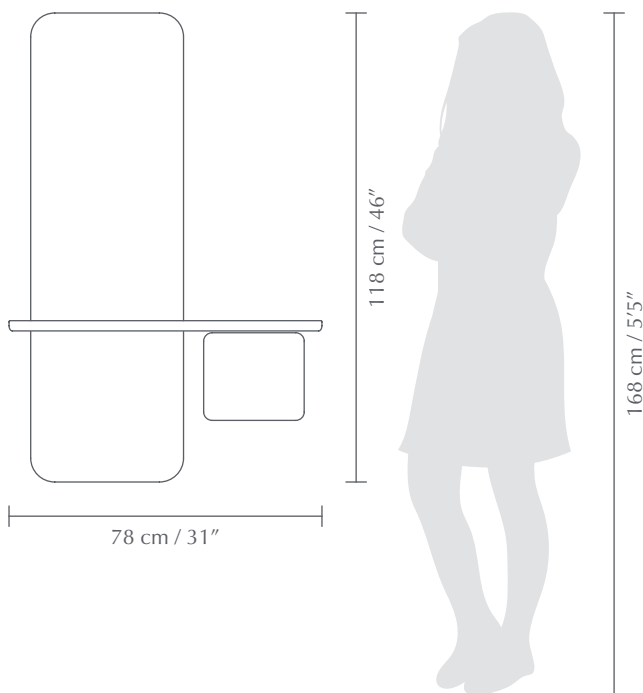

ONE MORE LOOK | MIRROR

Designed by Jonas Søndergaard

CATCH A GLANCE FROM ALL ANGLE

One More Look is a light and airy mirror with a minimalistic Scandinavian feel and a number of added functions to meet the everyday needs of urban living.

Taking up minimal space, One More Look is ideal for hallways of all sizes and could also work well in the bedroom or in hotels and office corridors.

The elegant full-length mirror is just the right height for checking your whole appearance before you leave home and inside the stylish coloured cabinet is an extra removable hand-held mirror.

Smaller items like your keys, makeup, sunglasses, bicycle lights and spare coins can be placed in the leather tray in the cabinet.

Find more inspiration at page 30, 58, 104



DIMENSIONS

H: 118 x W: 78 x D: 15 cm / H: 46 x W: 31 x D: 6"



MATERIAL

Solid oak, MDF, Glass, Steel (plated brass) and Leather (faux leather)



CONSTRUCTION

Wood: Solid oak. Dowel joinery. Reinforced with glue. Clear top coat wood finish. **Cabinet front:** Painted MDF. **Steel:** Main bracket is powder coated. **Chain & Hinges:** Brass plated **Magnets:** Heavy duty ferrite magnet. **Mirror:** Hardened glass. **Tray:** Leather (faux leather)



WEIGHT INCL. PACKAGING

Box 1: 13.5 kg / 30 lb
Box 2: 1 kg / 2.2 lb



PACKAGING DIMENSIONS (L x W x H)

Box 1: 86.5 x 46 x 23 cm / 34 x 18 x 9"
Box 2: 26.5 x 27.5 x 3.5 cm / 10.4 x 11 x 1.4"



ASSEMBLY TIME

45 min - video guide at umage.com



MEDIA KIT

Photos and press material
Download at umagepress.com



ORDERING INFORMATION

Oak pearl white	EU/UK/US/APAC #5620+5620-1
Oak anthracite grey	EU/UK/US/APAC #5620+5620-2
Oak forest green	EU/UK/US/APAC #5620+5620-3
Oak petrol blue	EU/UK/US/APAC #5620+5620-4
Oak ruby rose	EU/UK/US/APAC #5620+5620-5
Oak saffron yellow	EU/UK/US/APAC #5620+5620-6
Dark oak pearl white	EU/UK/US/APAC #5820+5620-1
Dark oak anthracite grey	EU/UK/US/APAC #5820+5620-2
Dark oak forest green	EU/UK/US/APAC #5820+5620-3
Dark oak petrol blue	EU/UK/US/APAC #5820+5620-4
Dark oak ruby rose	EU/UK/US/APAC #5820+5620-5
Dark oak saffron yellow	EU/UK/US/APAC #5820+5620-6
Black oak pearl white	EU/UK/US/APAC #5108+5620-1
Black oak anthracite grey	EU/UK/US/APAC #5108+5620-2
Black oak forest green	EU/UK/US/APAC #5108+5620-3
Black oak petrol blue	EU/UK/US/APAC #5108+5620-4
Black oak ruby red	EU/UK/US/APAC #5108+5620-5
Black oak saffron yellow	EU/UK/US/APAC #5108+5620-6

COLOUR VARIATIONS



oak



dark oak



black oak



pearl white
(RAL: 9001)



anthracite grey
(RAL: 7016)



forest green
(RAL: 6004)



petrol blue
(RAL: 3025)



ruby red
(RAL: 3032)



saffron yellow
(RAL: 1004)

NEW



TRAYS

Designed by Søren Ravn Christensen

GET ORGANISED

Three grab-and-go trays in felt or wood let you organise and hide away your mess on the shelves, inside the cabinet or drawers. The trays come in a pack of three sizes that fits both your loose leaves, magazines, and all other small items, that needs to be sorted. The felt trays has a design that is easy to disassemble, when not in use and comes in two grey colours. The wooden trays are made from solid oak with a front in Venetian cane and a soft velour covering inside. The wooden trays are available in natural oak and dark oak. All the trays fit perfectly into the Treasures™ cabinet and Stories™ shelving from the UIMAGE furniture collection.

Find more inspiration at page 62



DIMENSIONS (H x W x D)

12 cm x 24 cm x 35 cm / 4.7 x 9.4 x 13.8"
9 cm x 25 cm x 35 cm / 3.5 x 9 x 13.8"
6 cm x 30 cm x 35 cm / 2.4 x 12 x 13.8"



MATERIAL

Felt



MEDIA KIT

Photos and press material
Download at umagepress.com



ORDERING INFORMATION

Trays silver grey
Trays slate grey

EU/UK/US/APAC #5419
EU/UK/US/APAC #5420

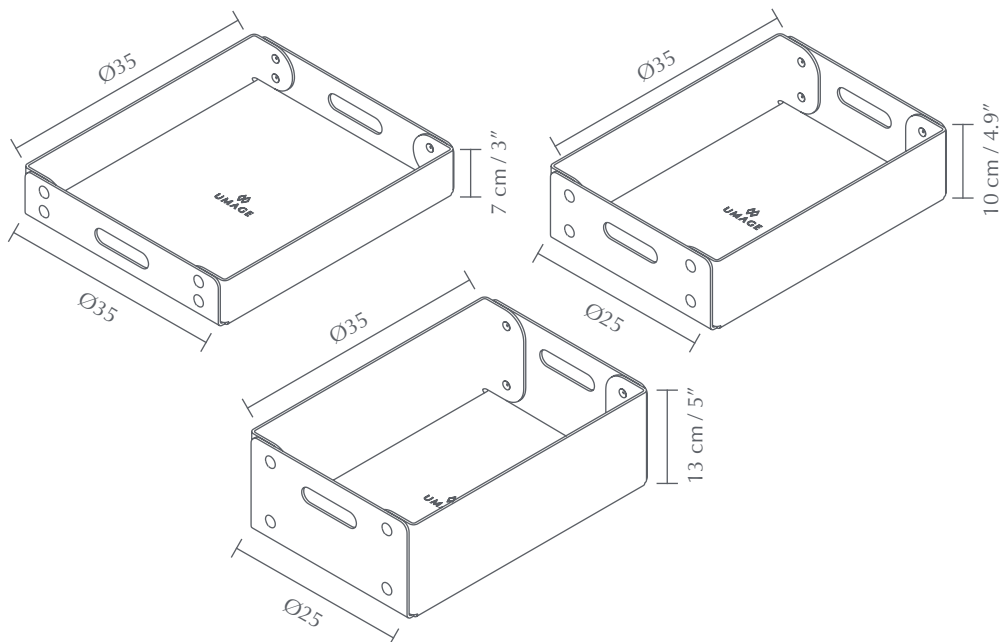

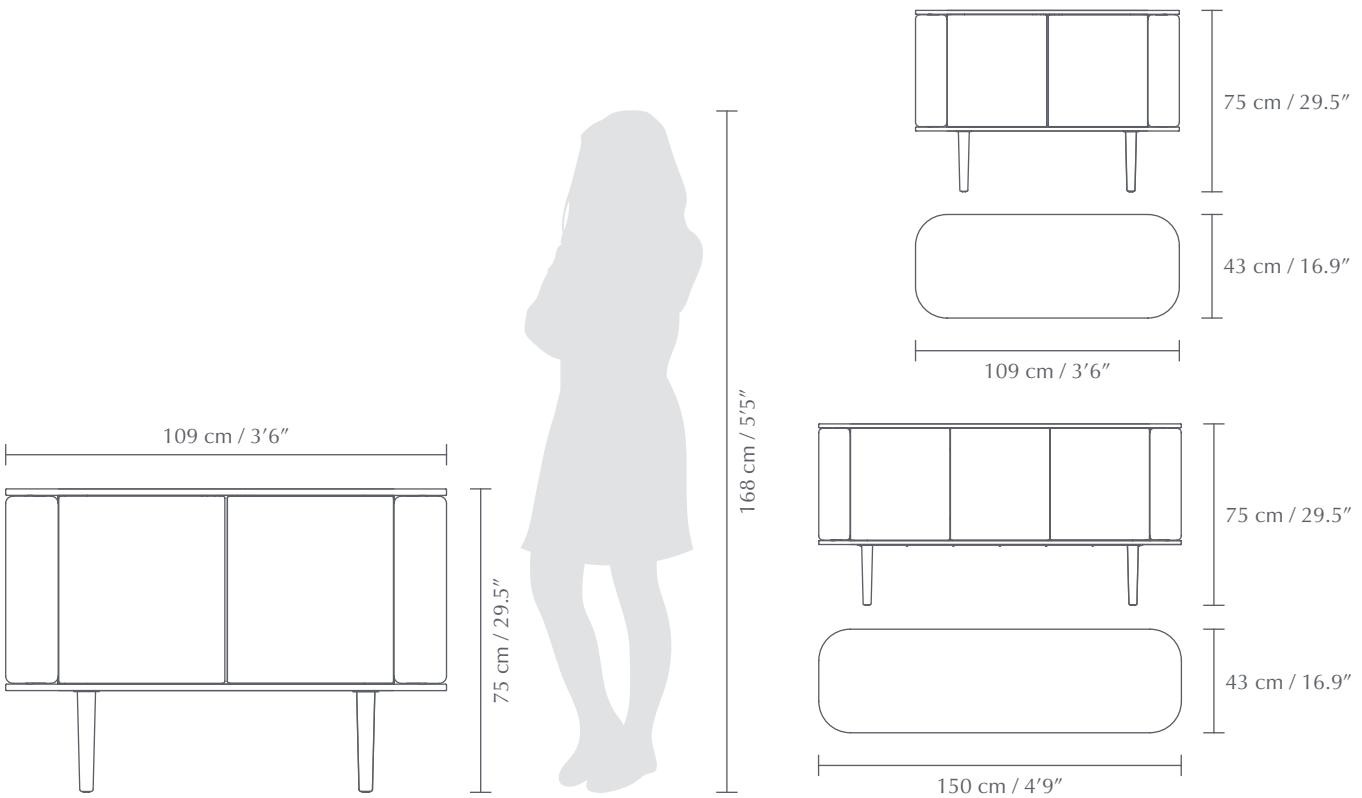

TREASURES | CABINET

Designed by Jonas Søndergaard

STORE YOUR MOST TREASURED ITEMS IN THE TREASURES™ CABINET

Treasures™ is a customisable cabinet made from veneered oak. The curved sides of the cabinet have a customisable covering that gives Treasures a soft tactile touch.

The customisable sides of the cabinet open as wings, that elegantly stores your fine liqueur or books. The storage compartments in the centre of the cabinet, each has one shelf, making it the perfect storage solution for your ceramics and porcelain.

Available in two sizes of 2- and 3-doors, in both natural and dark oak. The sides of the cabinet can be customised with venetian cane, textile or leather, making the stylish appearance flexible to match your personal style.

Find more inspiration at page 42, 91, 99



DIMENSIONS (W x H x D)

2-doors: 109 x 75 x 43 cm / 42.9 x 29.5 x 16.9"
3-doors: 150 x 75 x 43 cm / 59.1 x 29.5 x 16.9"



MATERIAL

Solid oak, Particle board and Steel



CONSTRUCTION

Frame: Veneered surfaces and solid edges with clear coat wood finish **Legs:** Solid oak. Legs attached with bolts.

Plate: Veneered chip board with solid oak lipping. **Fabric:** Polyester (Kingston). Find more information in the Kingston fabric spec sheet page 257.



PACKAGING DIMENSIONS (L x W x H)

2-doors:
Box 1: 16 x 115.5 x 54.5 cm / 6.3 x 45.5 x 21.5"
Box 2: 16.5 x 99 x 49 cm / 6.5 x 39 x 19.3"
3-doors:
Box 1: 16 x 156.5 x 54.5 cm / 6.3 x 61.6 x 21.5"
Box 2: 16.5 x 99 x 49 cm / 6.5 x 39 x 19.3"



ASSEMBLY TIME

40 min - video guide at umage.com



MEDIA KIT

Photos and press material
Download at umagepress.com



ORDERING INFORMATION

2-door oak silver grey	#5622+5622-1
2-door oak slate grey	#5622+5622-2
2-door oak venetian cane	#5622+5622-3
2-door oak hazelnut (faux leather)	#5622+5622-4
2-door dark oak silver grey	#5774+5774-1
2-door dark oak slate grey	#5774+5774-2
2-door dark oak venetian cane	#5774+5774-3
2-door dark oak hazelnut (faux leather)	#5774+5774-4
2-door black venetian cane	#5106+5106-3
3-door oak silver grey	#5623+5622-1
3-door oak slate grey	#5623+5622-2
3-door oak venetian cane	#5623+5622-3
3-door oak hazelnut (faux leather)	#5623+5622-4
3-door dark oak silver grey	#5775+5774-1
3-door dark oak slate grey	#5775+5774-2
3-door dark oak venetian cane	#5775+5774-3
3-door dark oak hazelnut (faux leather)	#5775+5774-4
3-door black oak venetian cane	#5107+5106-3

COLOUR VARIATIONS



oak



dark oak



black oak



silver grey



slate grey



venetian cane



FLOW | SHELF

Designed by Lasse Sortkjær

A FLOWING SHELF FOR THE WALL

Flow™, the new shelf that is flowing like waves on the wall – hence the name. Flow™ is the result of a designer's play with composition and materials, creating a strong visual attraction, while providing a steady functionality. A humble yet unconventional design.

"I wanted to challenge and confine the use of materials in the design to see how little is enough. My inspiration was trees growing in the forest. Trees are strong at the stem, but light and delicate at the twigs, just like Flow™" – Lasse Sortkjær, designer.

Flow™ is an artistic design piece and just by putting a few of your favorite objects on show, you will create a visual attraction to your living space. Flow™ comes in solid black stained ash, where the natural wooden surface shows, adding a warm appearance to the design.

Find more inspiration at page 81

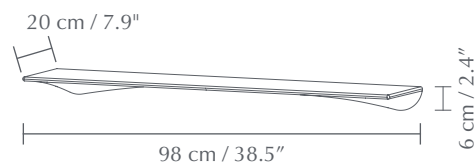

DIMENSIONS

W x H x D: 98 x 6 x 20 cm / 38.5 x 2.4 x 7.9"



MATERIAL

Ash and steel



CONSTRUCTION

CNC milled from solid ash wood



PACKAGING DIMENSIONS (W x H x D)

101 x 10 x 24 cm / 39.8 x 3.9 x 9.4"



ASSEMBLY TIME

20 min - video guide at umage.com



MEDIA KIT

Photos and press material
Download at umagepress.com



ORDERING INFORMATION

Black ash

EU/UK/US/APAC #5418



COLOUR VARIATIONS



black ash



TEASER | SHELF

Designed by Søren Ravn Christensen

SHOW ME, SHOW ME NOT, SHOW ME...

Instantly recognisable with its simple combination of graceful thin bars and slim sculptured metal, Teaser is the perfect shelf for displaying your favourite items.

Its linear design creates an eye-catching wall piece that suits virtually any room.

Teaser is ideal for all sorts of purposes, from keeping your papers in order to displaying your most treasured possessions.

Teaser's clever construction allows you to turn one shelf into three shelves on top of each other simply by adding 4 extra space rod bars and placing them in between two shelves.

Find more inspiration at page 98, 102



DIMENSIONS

HxWxD: 30 x 30 x 30 cm / 11.8 x 11.8 x 11.8"



MATERIAL

Aluminium and Steel



WEIGHT INCL. PACKAGING

3.2 kg / 7.1 lb



PACKAGING

Gift box dimensions (L x W x H):
33 x 33 x 7.5 cm / 13 x 13 x 3"



ASSEMBLY TIME

25 min - video guide at umage.com



MEDIA KIT

Photos and press materials
Download at umagepress.com



ORDERING INFORMATION

Teaser pearl white	EU/UK/US/APAC #5004
Teaser anthracite grey	EU/UK/US/APAC #5005
Teaser forest green	EU/UK/US/APAC #5006
Teaser petrol blue	EU/UK/US/APAC #5007
Teaser ruby red	EU/UK/US/APAC #5008
Teaser saffron yellow	EU/UK/US/APAC #5009
Space Rods	EU/UK/US/APAC #5010

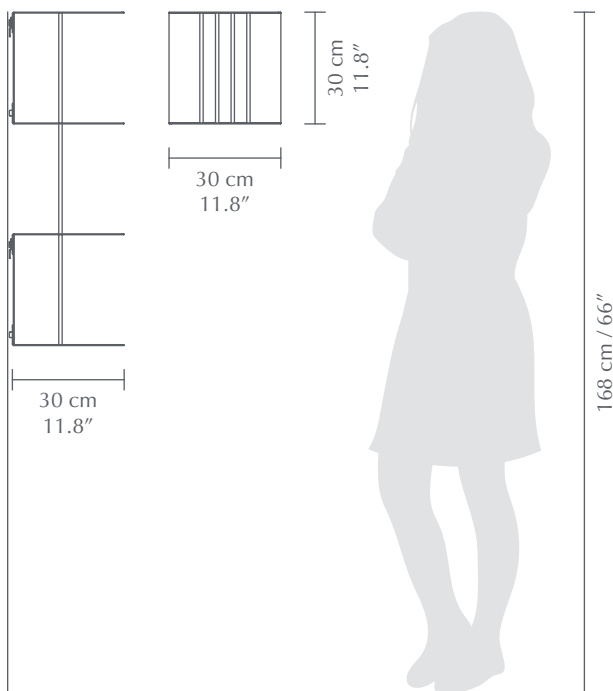
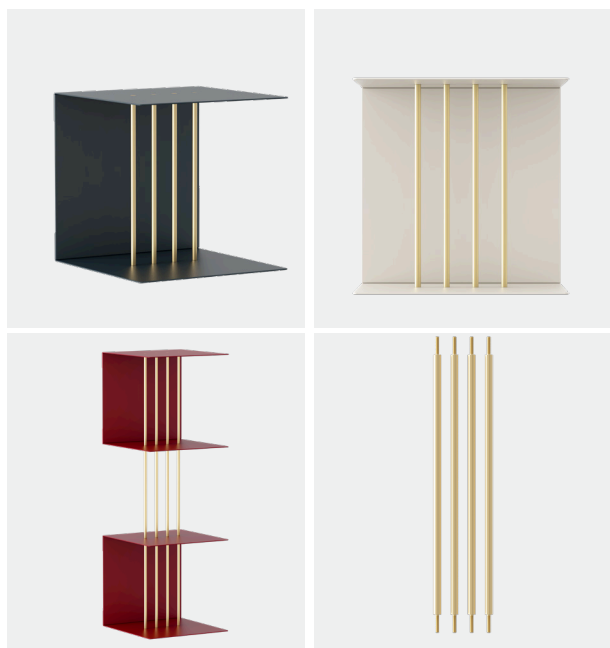

COLOUR VARIATIONS



pearl white
(RAL: 9001)

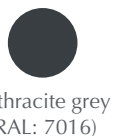

anthracite grey
(RAL: 7016)



forest green
(RAL: 6004)



petrol blue
(RAL: 3025)



ruby red
(RAL: 3032)



saffron yellow
(RAL: 1004)

NEW

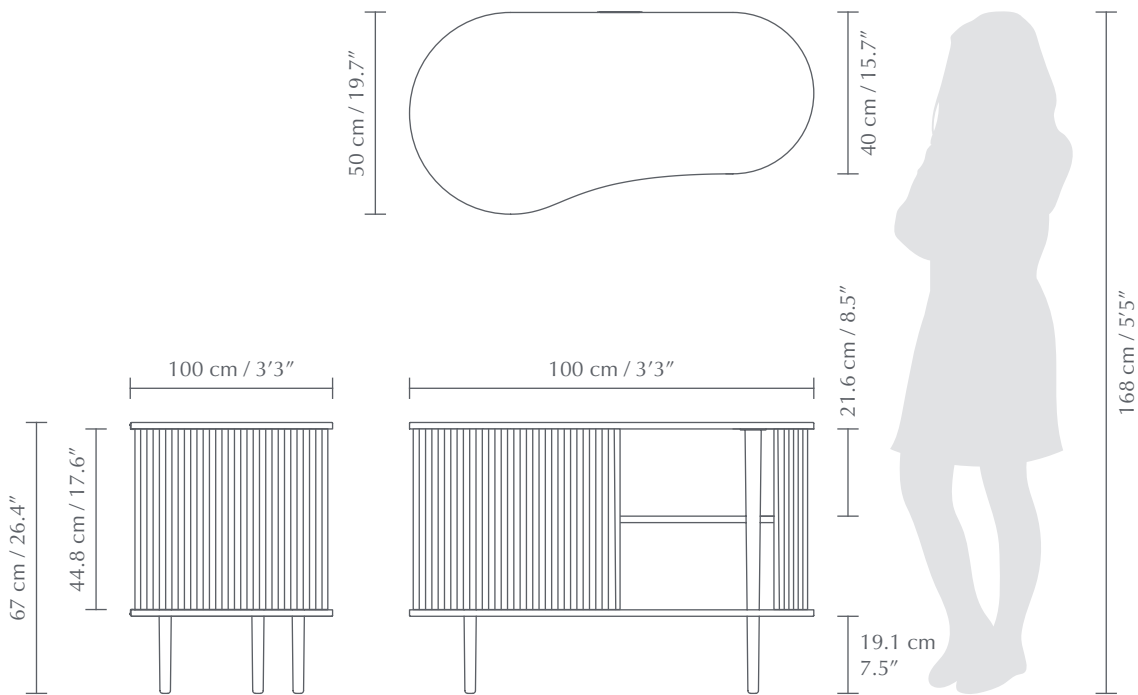

AUDACIOUS | CABINET

Designed by Jonas Søndergaard

SHOW AND TELL OR HIDE AND DISGUISE

Audacious is a cabinet with personality designed as a place for displaying your favourite pieces. Its special tambour doors slide around the edge of the cabinet, letting you choose how much of the interior you want to put on show. Change the position of the sliding doors to create new displays and uses.

Find more inspiration at page 25, 41, 84



DIMENSIONS

W x H x D: 100 x 67 x 50 cm / 39 x 26 x 20"



MATERIAL

Solid oak, MDF and Polyester (Marbella). Find more information in the Marbella fabric spec sheet.



CONSTRUCTION

Legs: Solid oak. Legs attached with insert bushings.
Plate: Oak veneered MDF. **Fabric:** 100% polyester. Moisture barrier added between fabric and filling to prevent moisture penetration. Leather handles on tambour made within the REACH standards.



WEIGHT INCL. PACKAGING

Box 1: 19.5 kg / 43 lb
Box 2: 3.5 kg / 8 lb



PACKAGING DIMENSIONS

Box 1: (L x W x H): 60 x 110 x 16 cm / 24 x 43.3 x 6.3"
Box 2: (L x W x H): 22 x 48 x 13 cm / 8.7 x 19 x 5"



ASSEMBLY TIME

30 min - video guide at umage.com



MEDIA KIT

Photos and press material
Download at umagepress.com



ORDERING INFORMATION

Oak petrol blue	EU/UK/US/APAC #5600+5600-1
Oak silver grey	EU/UK/US/APAC #5600+5600-2
Oak spring green	EU/UK/US/APAC #5600+5600-3
Oak dusty rose	EU/UK/US/APAC #5600+5600-4
Oak slate grey	EU/UK/US/APAC #5600+5600-5
Oak hazelnut	EU/UK/US/APAC #5600+5600-6
Dark oak petrol blue	EU/UK/US/APAC #5800+5600-1
Dark oak silver grey	EU/UK/US/APAC #5800+5600-2
Dark oak spring green	EU/UK/US/APAC #5800+5600-3
Dark oak dusty rose	EU/UK/US/APAC #5800+5600-4
Dark oak slate grey	EU/UK/US/APAC #5800+5600-5
Dark oak hazelnut	EU/UK/US/APAC #5800+5600-6
Black oak petrol blue	EU/UK/US/APAC #5111+5600-1
Black oak silver grey	EU/UK/US/APAC #5111+5600-2
Black oak spring green	EU/UK/US/APAC #5111+5600-3
Black oak dusty rose	EU/UK/US/APAC #5111+5600-4
Black oak slate grey	EU/UK/US/APAC #5111+5600-5
Black oak hazelnut	EU/UK/US/APAC #5111+5600-6

Colour variations



oak



dark oak



black oak



petrol blue



silver grey



spring green



dusty rose



slate grey



hazelnut

NEW

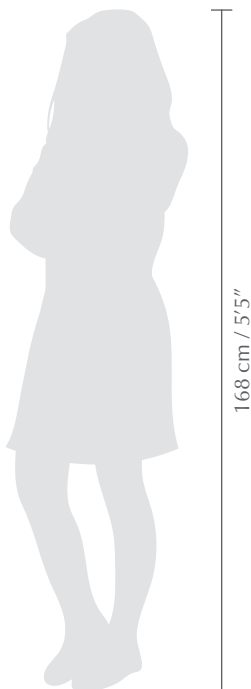
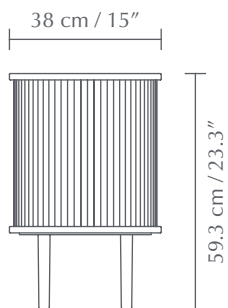

AUDACIOUS | SIDE TABLE

Designed by Jonas Søndergaard

PRACTICAL AND STYLISH SIDE TABLE WITH STORAGE

Audacious side table is very suitable as a bedside table in hotel rooms or next to the sofa.

Inside the table is a hidden USB-hub with four USB outlets and a micro-USB so the entire family can charge their phones and tablets at the same time.

The side table is a practical solution with storage space for your small bits and bobs. The inside shelf of Audacious is specially shaped with a cutaway section for higher items like books and magazines.

Find more inspiration at page 28, 32, 33, 35, 89



USB-hub with four USB outlets and a micro-USB hidden inside



DIMENSIONS

Ø: 38 cm / 15"
H: 59.3 cm / 23.3"



MATERIAL

Solid oak, MDF and Polyester (Marbella). Find more information in the Marbella fabric spec sheet.



CONSTRUCTION

Legs: Solid oak. Legs attached with insert bushings.

Plate: Oak veneered MDF. **Fabric:** 100% polyester. Moisture barrier added between fabric and filling to prevent moisture penetration. Leather handles on tambour made within the REACH standards.



WEIGHT INCL. PACKAGING

Box 1: 9 kg / 20 lb
Box 2: 1.5 kg / 3.3 lb



PACKAGING DIMENSIONS

Box 1 (L x W x H): 45.8 x 44.4 x 14.7 cm / 2 x 17.5 x 6"
Box 2 (L x W x H): 12 x 40 x 9 cm / 5 x 16 x 3.5"



ASSEMBLY TIME

30 min - video guide at umage.com



MEDIA KIT

Photos and press material
Download at umagepress.com



ORDERING INFORMATION

Oak petrol blue	EU/UK/US/APAC #5603+5603-1
Oak silver grey	EU/UK/US/APAC #5603+5603-2
Oak spring green	EU/UK/US/APAC #5603+5603-3
Oak dusty rose	EU/UK/US/APAC #5603+5603-4
Oak slate grey	EU/UK/US/APAC #5603+5603-5
Oak hazelnut	EU/UK/US/APAC #5603+5603-6
Black petrol blue	EU/UK/US/APAC #5113+5603-1
Black silver grey	EU/UK/US/APAC #5113+5603-2
Black spring green	EU/UK/US/APAC #5113+5603-3
Black dusty rose	EU/UK/US/APAC #5113+5603-4
Black slate grey	EU/UK/US/APAC #5113+5603-5
Black hazelnut	EU/UK/US/APAC #5113+5603-6

Colour variations



oak



dark oak



black oak



petrol blue



silver grey



spring green



dusty rose



slate grey



hazelnut

NEW

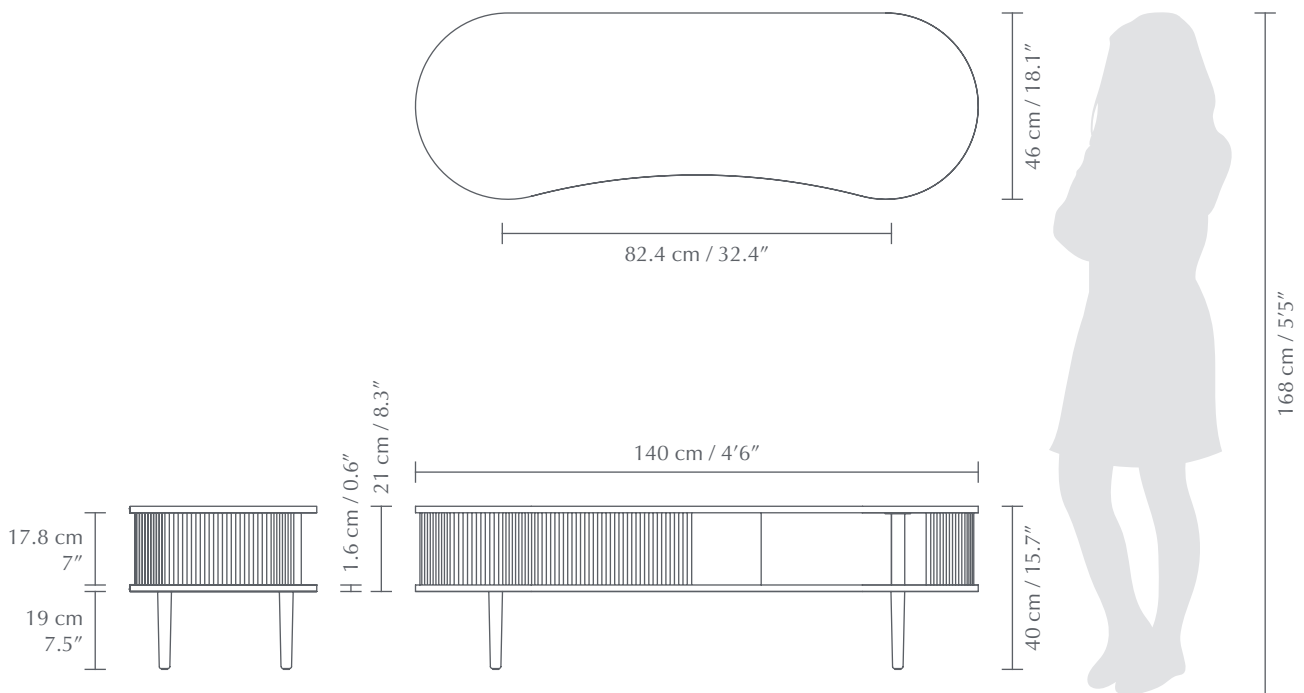

AUDACIOUS | TV BENCH

Designed by Jonas Søndergaard

MULTIPURPOSE BENCH

A multipurpose bench for seating or to hide your AV-equipment under the television. With a cable outlet in the back, it is easy to hide the messy cords.

Placed in the hallway it will store all your outdoor clothing, while you can take a seat as you put on your shoes.

Find more inspiration at page 26, 88, 104



DIMENSIONS

H: 40 x W: 140 x D: 46 cm / H: 15.7 x W: 55.1 x D: 18.1"



TESTS & CERTIFICATIONS

EU: Passed EN 16139 (L1) / EN 1022 & EN 16121 (L1) / EN 16122



MATERIAL

Solid oak, MDF and Polyester (Marbella). Find more information in the Marbella fabric spec sheet.



CONSTRUCTION

Legs: Solid oak. Legs attached with insert bushings.

Plate: Oak veneered MDF. **Fabric:** 100% polyester. Moisture barrier added between fabric and filling to prevent moisture penetration. Leather handles on tambour made within the REACH standards.



WEIGHT INCL. PACKAGING

Box 1: 20 kg / 44 lb
Box 2: 1.9 kg / 4 lb



PACKAGING DIMENSIONS

Box 1 (L x W x H): 148.4 x 52.4 x 10.3 cm / 58 x 21 x 4"
Box 2 (L x W x H): 10.5 x 26 x 20.5 cm / 4 x 10.2 x 8"



ASSEMBLY TIME

30 min - video guide at umage.com



MEDIA KIT

Photos and press material
Download at umagepress.com



ORDERING INFORMATION

Oak petrol blue	EU/UK/US/APAC #5601+5601-1
Oak silver grey	EU/UK/US/APAC #5601+5601-2
Oak spring green	EU/UK/US/APAC #5601+5601-3
Oak dusty rose	EU/UK/US/APAC #5601+5601-4
Oak slate grey	EU/UK/US/APAC #5601+5601-5
Oak hazelnut	EU/UK/US/APAC #5601+5601-6
Black petrol blue	EU/UK/US/APAC #5112+5601-1
Black silver grey	EU/UK/US/APAC #5112+5601-2
Black spring green	EU/UK/US/APAC #5112+5601-3
Black dusty rose	EU/UK/US/APAC #5112+5601-4
Black slate grey	EU/UK/US/APAC #5112+5601-5
Black hazelnut	EU/UK/US/APAC #5112+5601-6

Colour variations



oak



black oak



petrol blue



silver grey



spring green



dusty rose



slate grey



hazelnut

RECOMMENDED ACCS.

Seat Cushion

#5607

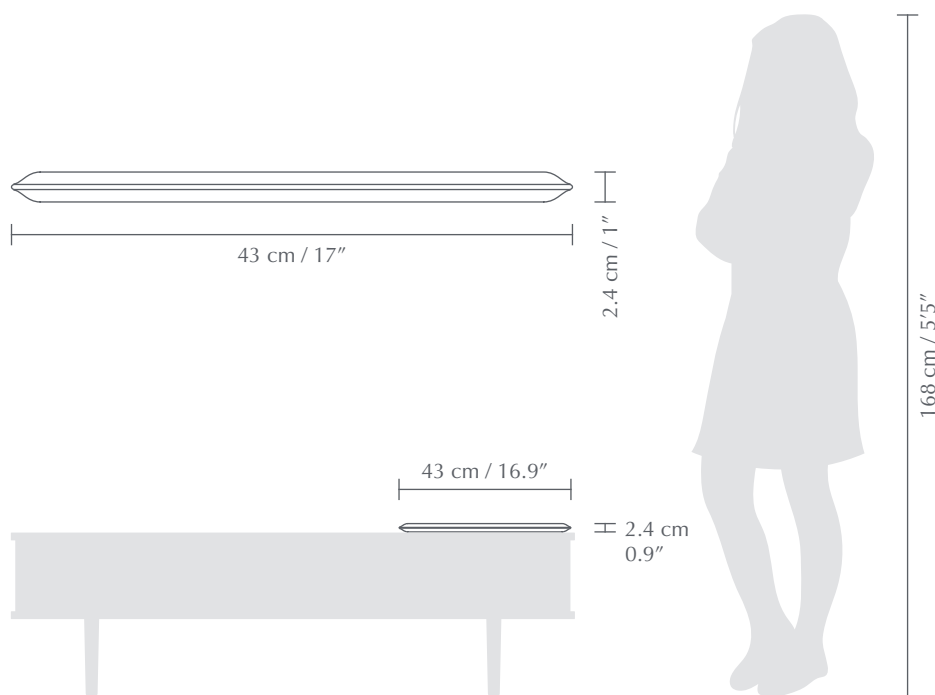

SEAT CUSHION

Designed by UIMAGE Design Team

ENHANCE THE SITTING COMFORT

Designed for the Audacious tv bench the leather Seat Cushion has been developed to add extra comfort when taking a seat on the bench. The Audacious tv bench can either be used under the television or as a normal bench in the living room or hallway.

The Seat Cushion can also be used on your dining table chairs to enhance the sitting comfort.

Find more inspiration at page 26



DIMENSIONS

Ø: 43 cm / 17"
H: 2.4 cm / 1"



MATERIAL

Leather (faux leather)



CONSTRUCTION

Cushion: 38 kg 150 Newton foam with PU leather.



WEIGHT INCL. PACKAGING

550 g / 1.2 lb



PACKAGING

Box dimensions (L x W x H):
43 x 43 x 3 cm / 17 x 17 x 1.2"



MEDIA KIT

Photos and press material
Download at umagepress.com



ORDERING INFORMATION

Seat Cushion EU/UK/US/APAC #5607



COLOUR VARIATIONS



brown

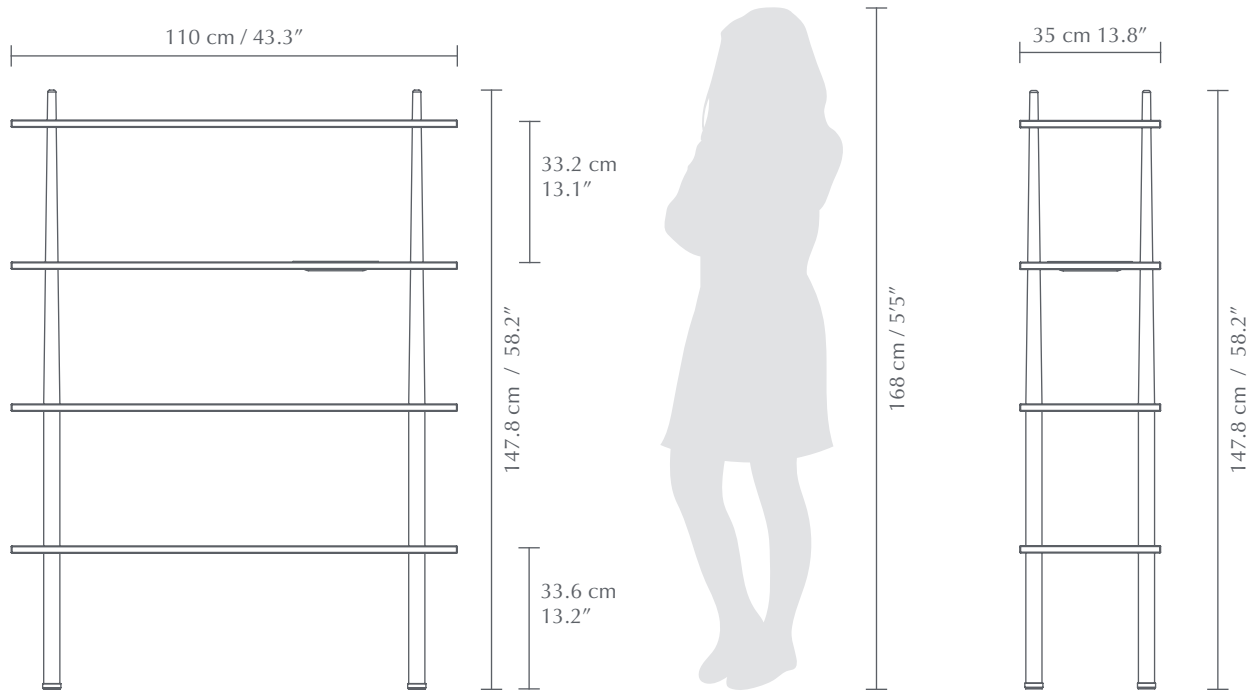

STORIES | SHELVING

Designed by Søren Ravn Christensen

FLEXIBLE SHELVING TO DISPLAY YOUR STORIES

Stories is a flexible shelving unit where you can put the things you love the most on display and share your life stories. Stories™ consists of 4 shelves, where one has a hole with a brass plate for your small bits and bobs. The Shelving unit also comes with three wooden trays that has a venetian cane front making it easy to beautifully hide away your messy stuff.

Stories™ can be expanded to the size you need and personalized with the several shelving accessories, including a glass bowl, extra storage trays and a side table. Stories is made from oak and has a simple visual attraction with its four conical legs that creates an agile and dainty appearance. The shelving system comes with four brass feet that can be adjusted and levelled to the slanting floors often seen in the old apartments of Copenhagen.

Remove the brass plate and exchange it with the glass bowl accessory to create a beautiful indoor terrarium planter or even hold a goldfish. Add the round corner table accessory to the side of the shelving system to display a plant or other things that need that extra important spot in your space. The three wooden trays accessory with a venetian cane front make it easy to beautifully hide away your otherwise messy stuff.

Find more inspiration at page 39, 88, 94



DIMENSIONS (H x W x D)

Stories: 147.8 x 110 x 35 cm / 58.2 x 43.3 x 13.8"

Trays:

13 cm x 25 cm x 35 cm / 5 x 9 x 13.8"

10 cm x 25 cm x 35 cm / 4 x 9 x 13.8"

7 cm x 30 cm x 35 cm / 3 x 12 x 13.8"



MATERIAL

Stories: Solid oak, MDF and Steel

Trays: Solid oak, Particle board and Venetian cane



WEIGHT INCL. PACKAGING

27.5 kg / 60.6 lb



PACKAGING DIMENSIONS (L x W x H)

118 x 42 x 17 cm / 46.5 x 16.5 x 6.7"



ASSEMBLY TIME

15-20 min - video guide at umage.com



MEDIA KIT

Photos and press material

Download at umagepress.com



ORDERING INFORMATION

Stories oak

EU/UK/US #5621+5621-4

Stories dark oak

EU/UK/US #5773+5773-4

RECOMMENDED ACCESSORIES

Trays oak

EU/UK/US/APAC #5621-4

Trays dark oak

EU/UK/US/APAC #5773-4

Round Corner table oak

EU/UK/US/APAC #5621-3

Round Corner table dark oak

EU/UK/US/APAC #5773-3

Bowl

EU/UK/US/APAC #5413

Shelf oak

EU/UK/US/APAC #5621-1

Shelf dark oak

EU/UK/US/APAC #5773-1

Shelf with hole oak

EU/UK/US/APAC #5621-2

Shelf with hole dark oak

EU/UK/US/APAC #5773-2

COLOUR VARIATIONS



oak



dark oak

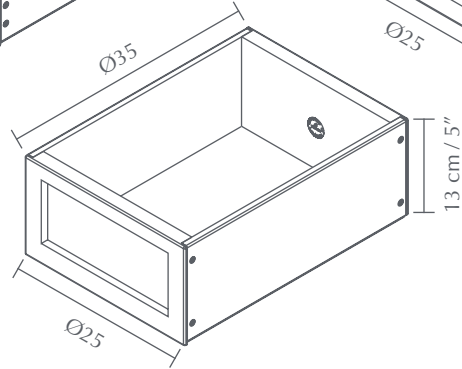
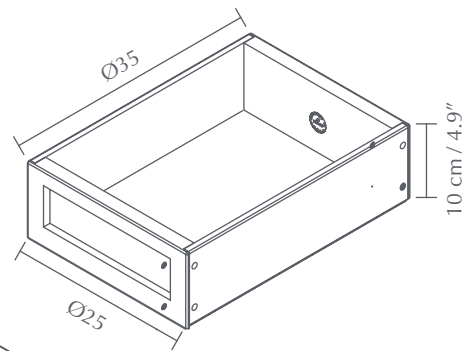
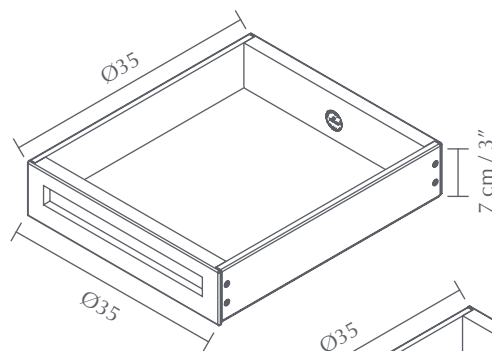
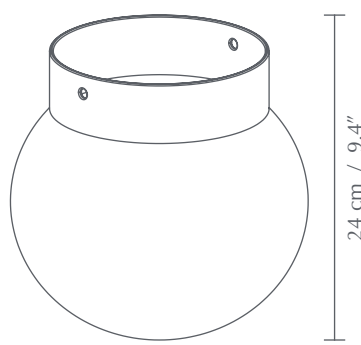
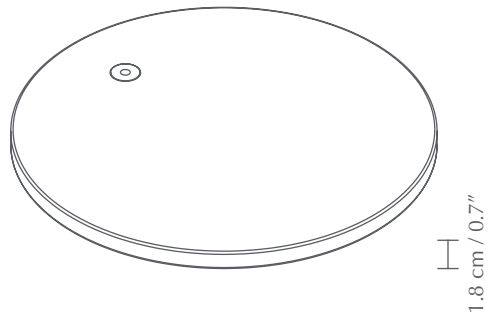
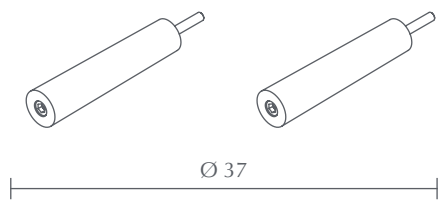

ACCESSORIES FOR STORIES

Designed by Søren Ravn Christensen

EXTEND THE STORIES YOU WANT TO TELL

With the Stories accessories you can add extra functionality to the Stories. One of the shelves has a hole with a brass tray for your small bits and bobs. You can also use the hole for the available glass bowl accessory. In the glass bowl you can create your own indoor terrarium planter or even hold a goldfish. Add the round corner table accessory to the side of the shelving system to display a plant or other things that need that extra important spot in your space. The three wooden trays accessory with a venetian cane front make it easy to beautifully hide away your otherwise messy stuff.

Find more inspiration at page 39, 88, 94

ROUND CORNER TABLE



DIMENSIONS

Ø: 37 H: 1.8 cm / 0.7"



MATERIAL

Solid oak



MEDIA KIT

Photos and press material
Download at umagepress.com



ORDERING INFORMATION

Round Corner Table oak EU/UK/US/APAC #5621-3
Round Corner Table dark oak EU/UK/US/APAC #5773-3



BOWL



DIMENSIONS

Ø: 24 H: 24 cm / 9.4"



MATERIAL

Glass and steel (plated brass)



MEDIA KIT

Photos and press material
Download at umagepress.com



ORDERING INFORMATION

Bowl EU/UK/US/APAC #5413



TRAYS



DIMENSIONS (H x W x D)

13 cm x 25 cm x 35 cm / 5 x 9 x 13.8"
10 cm x 25 cm x 35 cm / 4 x 9 x 13.8"
7 cm x 30 cm x 35 cm / 3 x 12 x 13.8"



MATERIAL

Solid oak, Particle board and Venetian cane



MEDIA KIT

Photos and press material
Download at umagepress.com



ORDERING INFORMATION

Trays oak EU/UK/US/APAC #5621-4
Trays dark oak EU/UK/US/APAC #5773-4



EXTRA SHELF | FOR STORIES

Designed by Søren Ravn Christensen



DIMENSIONS (H x W x D)

35 cm x 110 x 35 cm / 13.8 x 43.3 / 13.8"



MATERIAL

Solid oak and MDF



MEDIA KIT

Photos and press material
Download at umagepress.com



ORDERING INFORMATION

Extra Shelf oak	EU/UK/US/APAC #5621-1
Extra Shelf dark oak	EU/UK/US/APAC #5773-1

EXTEND THE STORIES YOU WANT TO TELL

Expand the size of the Stories shelving with extra shelves and create the size you need. Available in oak and dark oak with and without a hole.

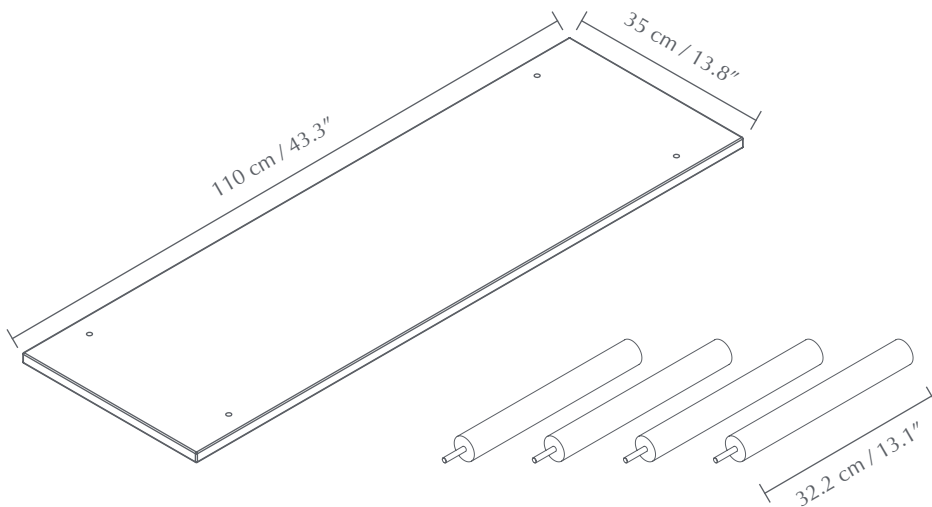

EXTRA SHELF WITH HOLE | FOR STORIES

Designed by Søren Ravn Christensen



DIMENSIONS (H x W x D)

35 cm x 110 x 35 cm / 13.8 x 43.3 / 13.8"



MATERIAL

Solid oak and MDF



MEDIA KIT

Photos and press material
Download at umagepress.com



ORDERING INFORMATION

Extra Shelf with hole oak EU/UK/US/APAC #5621-2
Extra Shelf with hole dark oak EU/UK/US/APAC #5773-2

EXTEND THE STORIES YOU WANT TO TELL

Expand the size of the Stories shelving with extra shelves and create the size you need. Available in oak and dark oak with and without a hole. Use the hole for the available brass plate or glass bowl, accessory. You can also add your own planters to implement your plants to the look of your shelving system.

Find more inspiration at page 88

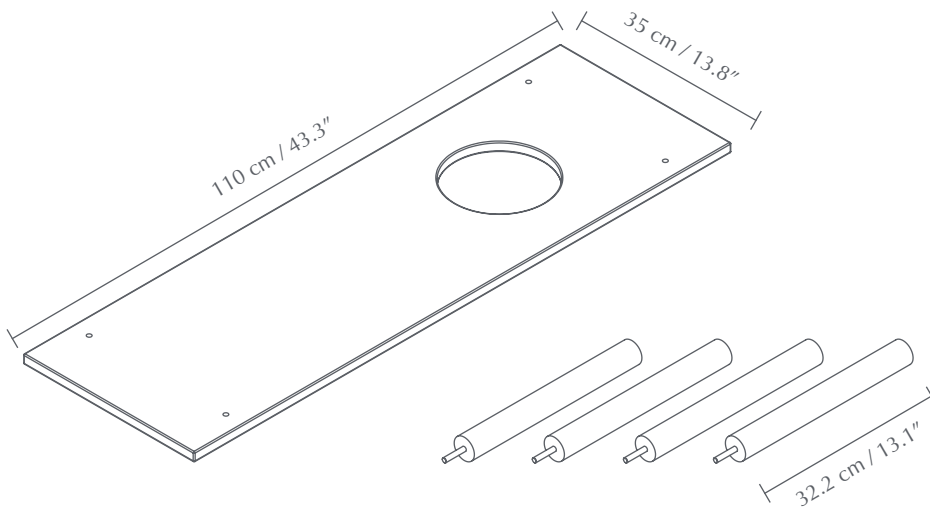

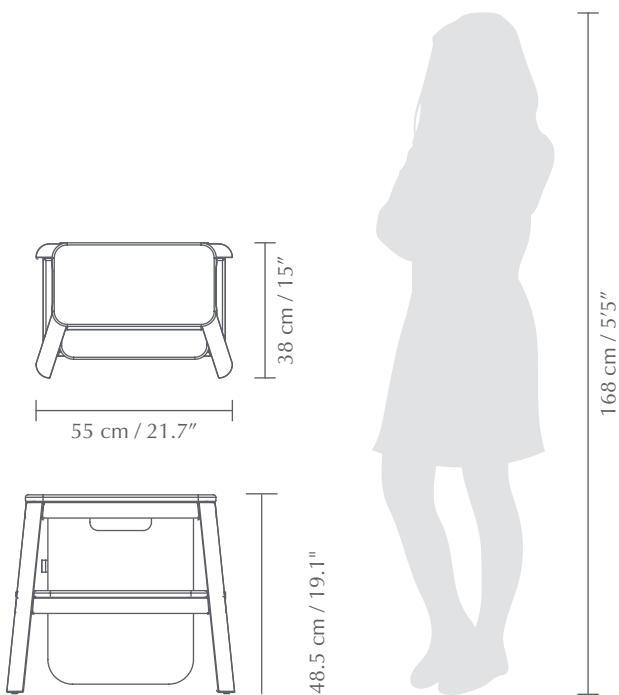
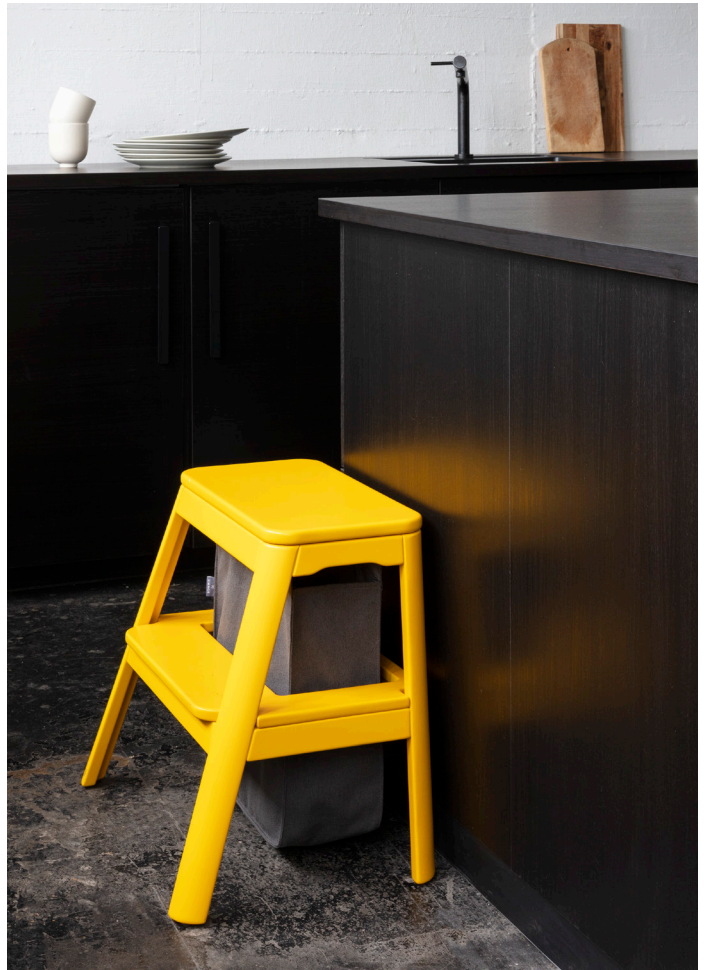

STEP IT UP | STEP STOOL

Designed by Søren Ravn Christensen

STEP IT UP™ FOR THE ENVIRONMENT

The step stool that will help you to reach the higher shelves in the kitchen and encourage you to step it up for the environment – hence the name.

Step It Up™ holds a storage bag that can be taken out and used for grocery shopping, to store your recycled bottles, or other things that you simply need space to store. The new step stool encourages you to minimise the use of plastic bags and sort your recyclable waste, making it easier to take better care for the environment in your everyday life, while enhancing the functionality in our living space.

The step stool comes in two subtle and two vibrant colours so there a little something for every taste. You can step up from three sides of the stepping stool and it has antifriction shoes to make sure you always have a steady balance on the stool. The bag can be washed in the washer on 30 degrees.



DIMENSIONS

W x H x D: 55 x 48 x 38 cm / 21.9 x 19.1 x 15"



MATERIAL

Solid oak, MDF, Polyester and Hardwood



CONSTRUCTION

Frame: Painted solid hardwood. Legs: Painted solid hardwood. Lig: Painted MDF. Fabric: Washable polyester. Bag handles: Solid oak.



PACKAGING DIMENSIONS

(L x W x H): 58 x 48 x 17.5 cm / 22.8 x 18.9 x 6.9"



ASSEMBLY TIME

30 min - video guide at umage.com



MEDIA KIT

Photos and press material
Download at umagepress.com



ORDERING INFORMATION

Step It Up pearl white	EU/UK/US/APAC #5414
Step It Up anthracite grey	EU/UK/US/APAC #5415
Step It Up ruby red	EU/UK/US/APAC #5416
Step It Up saffron yellow	EU/UK/US/APAC #5617



COLOUR VARIATIONS



pearl white
(RAL: 9001)



anthracite grey
(RAL: 7016)



ruby red
(RAL: 3032)



saffron yellow
(RAL: 1004)



LEAN ON ME | CLOTHES RACK

Designed by Jonas Søndergaard

GREAT STORAGE FOR SMALL SPACES

The Lean On Me clothes rack lets you comfortably store all of your outdoor essentials whilst still making the most of the space available.

Designed to lean at an angle away from the wall at its base, Lean On Me takes up almost no space on the floor.

Perfect for narrow hallways and other places where room is tight, its head turning design makes it an impressive piece to greet visitors in the important entrance area of the home.

Find more inspiration at page 57, 61, 101, 107



DIMENSIONS

H: 182 x W: 78 x D: 32 cm / 71.7 x W: 30.7 x D: 12.6"



MATERIAL

Steel (plated brass) and Leather (faux leather)



CONSTRUCTION

Steel: Painted. Electroplated steel (brass look). Steel pipes are joined using rivets. 4 suitable wall screws needed for given wall (screws and rawlplugs not included). 2 pinol screws to mount top shelf to wall brackets (screws and rawlplugs not included).



WEIGHT INCL. PACKAGING

8.2 kg / 18.1 lb



PACKAGING DIMENSIONS

(L x W x H): 81 x 35 x 6 cm / 31.9 x 13.8 x 2.4"



ASSEMBLY TIME

30 min - video guide at umage.com



MEDIA KIT

Photos and press material
Download at umagepress.com



ORDERING INFORMATION

Lean On Me white EU/UK/US/APAC #5250
Lean On Me black EU/UK/US/APAC #5251

COLOUR VARIATIONS



white



black



78 cm / 30.7"

32 cm / 12.6"

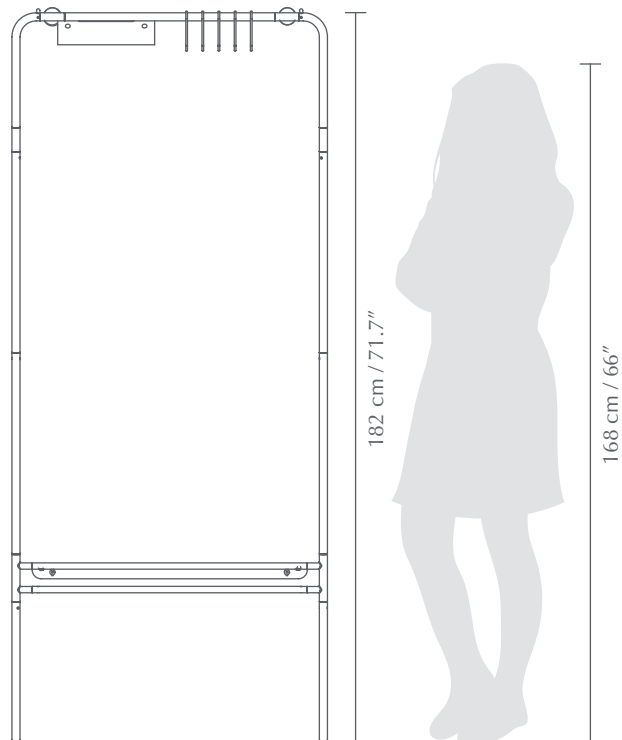

182 cm / 71.7"

168 cm / 66"

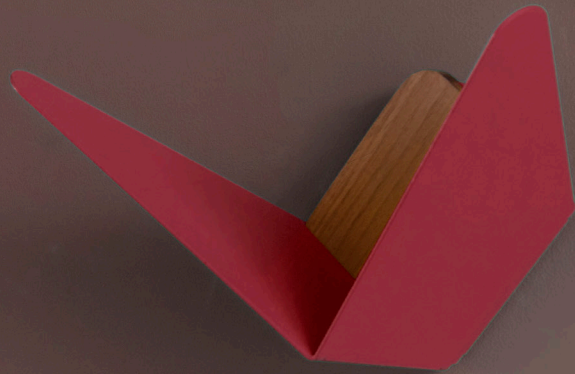

BUTTERFLIES | HOOK

Designed by Makers With Agendas

MAKE YOUR URBAN LIFE A NATURAL ONE, LIKE BUTTERFLIES IN THE SKY

Butterflies is a multipurpose dual coat hook that keeps your small items just where you need them. Butterflies comes with both an oak and dark oak back cover, letting you decide the look.

Its stylish and minimal form makes an eye-catching design statement in the home, office or other interior setting. The coat hook has two wings just right for hanging jackets and scarves and a small shelf for placing your keys and wallet.

Find more inspiration at page 103, 105

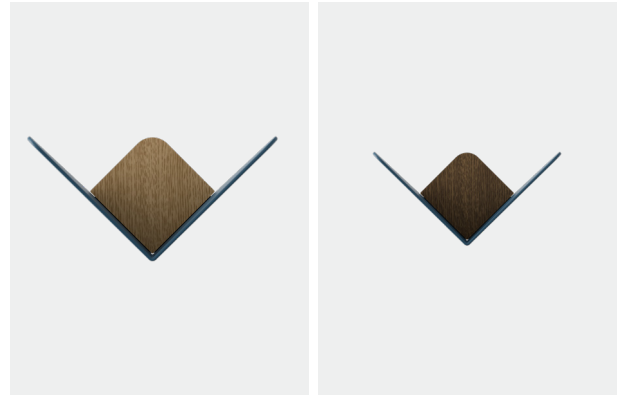

DIMENSIONS (HxWxD)

Mini: 8.5 x 17 x 9.2 cm / 3.3 x 6.7 x 3.6"

Medium: 11.3 x 22.6 x 12.2 cm / 4.4 x 8.9 x 4.8"



MATERIAL

Solid oak and Steel



CONSTRUCTION

Steel: Powder coated. Foldable steel.



WEIGHT INCL. PACKAGING

Mini: 380 g / 0.8 lb

Medium: 640 g / 1.4 lb



PACKAGING (Gift box dimensions)

Mini LxWxH: 24.1x15.2x1.4 cm / 9.5x6x0.6"

Medium LxWxH: 32.5x20x1.4 cm / 12.8x7.9x0.6"



ASSEMBLY TIME

10 min - video guide at umage.com



MEDIA KIT

Photos and press materials

Download at umagepress.com



ORDERING INFORMATION

Pearl white	mini #5260	medium #5280
Anthracite grey	mini #5261	medium #5281
Forest green	mini #5262	medium #5282
Petrol blue	mini #5263	medium #5283
Ruby red	mini #5264	medium #5284
Saffron yellow	mini #5265	medium #5285

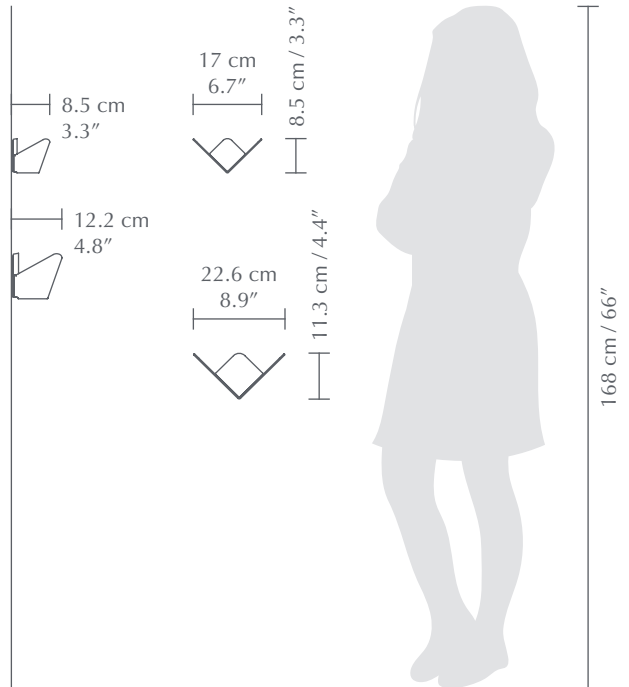

COLOUR VARIATIONS



pearl white
(RAL: 9001)



anthracite grey
(RAL: 7016)



forest green
(RAL: 6004)



petrol blue
(RAL: 3025)



ruby red
(RAL: 3032)



saffron yellow
(RAL: 1004)

MARBELLA | FABRIC

For Audacious cabinet, Audacious side table, Audacious tv bench & Lounge Around



COMPOSITION

100% Polyester

FLAME RESISTANCE

BS 5852 (UK)
EN 1021-1 / EN 1021-2 (EU)
TB 117 (US)

COLOUR FASTNESS TO RUBBING EN ISO 105X12:2002

4-5 (1 is bad and 5 is good)

ABRASION RESISTANCE EN ISO 12947-2:1999
MARTINDALE WEAR AND ABRASION TESTER 12KPA
40000 rubs

PILLING RESISTANCE EN ISO 12945-2:2000

MARTINDALE TESTER < 1 SEC
4-5 (1 is bad and 5 is good)

COLOUR VARIATIONS

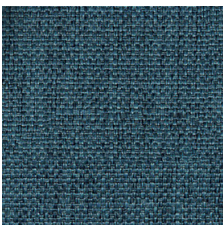

petrol blue

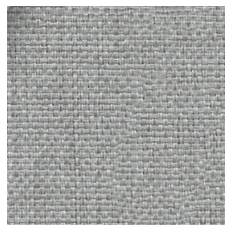

silver grey

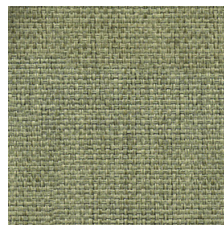

spring green

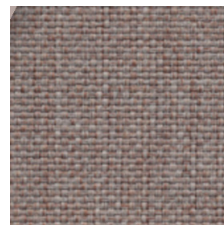

dusty rose



slate grey

KINGSTON | FABRIC

For A Conversation Piece low, A Conversation Piece tall, A Conversation Piece ottoman, The Reader, The Reader ottoman & Time Flies



COMPOSITION

100% Polyester

FLAME RESISTANCE

BS 5852 (UK)
EN 1021-1 / EN 1021-2 (EU)
TB 117 (US)

COLOUR FASTNESS TO RUBBING EN ISO 105X12:2002

4-5 (1 is bad and 5 is good)

ABRASION RESISTANCE EN ISO 12947-2:1999
MARTINDALE WEAR AND ABRASION TESTER 12KPA
40000 rubs

PILLING RESISTANCE EN ISO 12945-2:2000

MARTINDALE TESTER < 1 SEC
4-5 (1 is bad and 5 is good)

COLOUR VARIATIONS

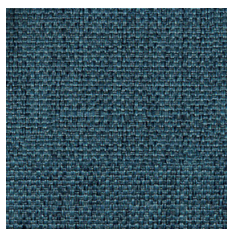

petrol blue

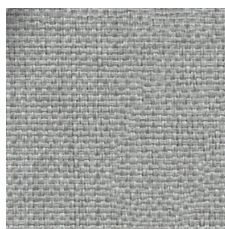

silver grey



spring green

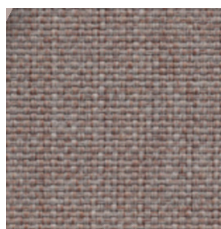

dusty rose

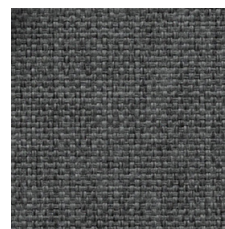

slate grey

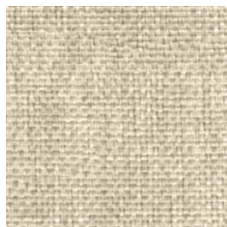

sand

TEDDY BEAR | FABRIC

For A Conversation Piece low, A Conversation Piece tall, A Conversation Piece ottoman, The Reader & Time Flies



COMPOSITION

100% Polyester

FLAME RESISTANCE

BS 5852 (UK)

TB 117 (US)

COLOUR FASTNESS TO RUBBING EN ISO 105X12:2002

4-5 (1 is bad and 5 is good)

ABRASION RESISTANCE EN ISO 12947-2:2016

MARTINDALE WEAR AND ABRASION TESTER 12KPA

>50000 rubs

PILLING RESISTANCE EN ISO 12945-2:2000

MARTINDALE TESTER < 1 SEC

4-5 (1 is bad and 5 is good)

COLOUR VARIATIONS

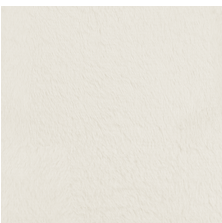

teddy white

FABRIC AND LEATHER SPECIFICATIONS

For Time Flies



rusty brown

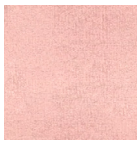

pale rose

Fabric name: Velour I
Composition: 100% Polyester
Color fastness: 4-5* (to rubbing EN ISO 105X12:2002)

Abrasion resistance: >50.000 rubs (EN ISO 12947-2:1999)
Martindale wear & abrasion tester 12kPa
Pilling resistance: 4-5* (EN ISO 12945-2:2000 Martindale tester)
Tearing strenght: Length direction 50.0 N
Width direction 55.8 N
(EN ISO 13937-3:2000 Wing-rip)



forest green

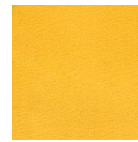

canary yellow

Fabric name: Velour II
Composition: 100% Polyester
Color fastness: 4-5* (to rubbing EN ISO 105X12:2002)

Abrasion resistance: >50.000 rubs (EN ISO 12947-2:1999)
Martindale wear & abrasion tester 12kPa
Pilling resistance: 4-5* (EN ISO 12945-2:2000 Martindale tester)
Tearing strenght: Warp direction 62.9 N
Weft direction 52.7 N
(EN ISO 13937-3:2000 Wing-rip)

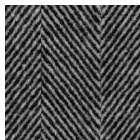

tweed**

Fabric name: Herringbone
Composition: 80% Polyester, 20% Wool
Color fastness: 4-5* (to rubbing EN ISO 105X12:2016)

Abrasion resistance: >50.000 rubs (EN ISO 12947-2:2016)
Martindale wear & abrasion tester 12kPa
Pilling resistance: 2-3* (EN ISO 12945-2:2000 Martindale tester)
Tearing strenght: Warp direction 87.1 N
Weft direction 46.7 N
(EN ISO 13937-3:2000 Wing-rip)

**This type of fabric is only available on the front of the chair

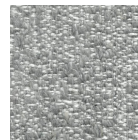

wellington**

Fabric name: Meadow
Composition: 78% Polyester, 10% Acrylic, 7% Linen, 5% Wool
Color fastness: 4-5* (to rubbing EN ISO 105X12:2002)

Abrasion resistance: >50.000 rubs (EN ISO 12947-2:1999)
Martindale wear & abrasion tester 12kPa
Pilling resistance: 4-5* (EN ISO 12945-2:2000 Martindale tester)
Tearing strenght: Warp direction 456.4 N
Weft direction 599.0 N
(EN ISO 13937-3:2000 Wing-rip)

**This type of fabric is only available on the back of the chair



burnt almond**

Fabric name: Faux leather II
Composition: 100% Polyester
Color fastness: 4-5* (to rubbing EN ISO 105X12:2002)
Abrasion resistance: >50.000 rubs (EN ISO 12947-2:1999)
Martindale wear & abrasion tester 12kPa
Pilling resistance: 4-5* (EN ISO 12945-2:2000 Martindale tester)
Tearing strenght: Length direction 72.6 N
Width direction 34.0 N
(EN ISO 13937-3:2000 Wing-rip)
Smolder time: 30 min 18 sec (CA TB 117:2013)
Vertical char length: 20.0 (CA TB 117:2013)

**This type of fabric is only available on the back of the chair



hazelnut**

Fabric name: Faux leather I
Composition: 100% Polyester
Color fastness: 4-5* (to rubbing EN ISO 105X12:2002)
Abrasion resistance: >50.000 rubs (EN ISO 12947-2:1999)
Martindale wear & abrasion tester 12kPa
Pilling resistance: 4-5* (EN ISO 12945-2:2000 Martindale tester)
Tearing strenght: Warp direction 38.4 N
Weft direction 29.0 N
(EN ISO 13937-3:2000 Wing-rip)

**This type of fabric is only available on the back of the chair

**Scale: 1 is bad and 5 is good



LEATHER FROM SORENSEN LEATHER

For A Conversation Piece low, The Reader wing chair & The Reader ottoman



DUNES | Leather from Sorensen Leather

The DUNES collection has received the Nordic Swan Ecolabel. A highly-respected certification verifying that it meets their rigorous requirements regarding the environment, use of energy and resources. A special process involving sanding, buffing and applying a special type of leather oil to the surface gives it that almost velvety

touch. At the same time, DUNES boasts a matt look that's raw with a touch of understated elegance. Part of DUNES' extra appeal are the subtle, natural markings which bring a unique personality to each hide. The five colours we feature will also vary from hide to hide and with each individual hide. Watch for a delicious patina

that will appear over time as a result of the leather's exposure to daylight, interior lighting and usage. In fact, the more you use DUNES, the more the leather becomes shinier and smoother.

Name:	DUNES	Finish:	Special leather oil to enhance the body
Type:	Aniline leather	Tannage:	Chrome-free
Thickness:	1.1 – 1.3 mm	Dye:	Water-based Aniline dye
Size:	4.5 – 5.5 m ²	Particular attributes:	Discrete exclusivity in a natural look that wears beautifully
Origin:	European rawhide, typically from Italy, Germany, Austria, Switzerland and Scandinavia	Price:	Upon request
Surface:	An elegant, matt surface with a somewhat velvety look and feel	Delivery time:	Within 6 weeks

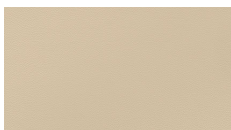
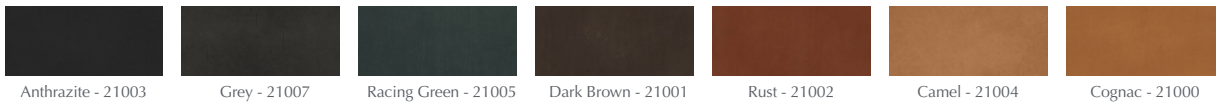

ULTRA | Leather from Sorensen Leather

One of the most versatile leathers around, ULTRA is everything you would want in an "everyday" type of leather. Buffed and embossed and truly nice to touch, the surface of ULTRA boasts a uniform grain pattern spanning

over the entire hide. Making it a dream to work with for designers. ULTRA has some additional amazing attributes. Thanks to its extremely strong protective finish, it's very user-friendly and easy to maintain. Stains don't even leave

a mark once wiped away using a fresh cloth with water. What's more, as a leather with a heavy surface protection, ULTRA will take longer to show signs of aging or fading due to exposure to light.

Name:	ULTRA	Tannage:	Chrome
Type:	Protected leather	Dye:	Water-based Aniline dye
Thickness:	0.9 – 1.1 mm	Particular attributes:	Water repellent, dirt repellent, stain resistant, durable, easy upkeep. A very strong leather that's smudge-proof, able to withstand wear and tear, showing little signs of aging or the effects of exposure to light
Size:	4.0 – 5.0 m ²	Price:	Upon request
Origin:	Non European	Delivery time:	Within 6 weeks
Surface:	Very strong and durable with a uniform, matt surface print		
Finish:	Extremely strong surface protection		



UPHOLSTERIES FROM KVADRAT

For A Conversation Piece low, The Reader wing chair & The Reader ottoman

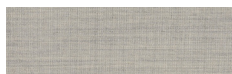

Canvas 2 | Upholstery from Kvadrat

Canvas is a vibrant woollen upholstery textile created by Giulio Ridolfo. Particularly well-suited to large surfaces thanks to its pronounced structure, it features a soft weave and an expanded palette inspired by the landscapes

of Skagen, Denmark. The melange yarn used to craft Canvas combines three colours, with six hues in every colourway. Consequently, the textile offers exceptional colour richness and an intriguing expression. From a di-

stance, it has the calm surface of a unicoloured textile. But, get closer, and shimmering colour nuances, delicate contrasts and an elegant structure emerge.

Name: Canvas 2
 Designer: Giulio Ridolfo
 Type: Upholstery
 Pattern: Solid
 Composition: 90% New wool (worsted), 10% Nylon

Weight: 480 g/lin.m
 Width: 140 cm
 Durability: 100.000 Martindale
 Pilling: 4
 Lightfastness: 5-7

Sustainability: Complies with EU Ecolabel "The Flower"
 Manufactured in: United Kingdom
 Price: Upon request
 Delivery time: Within 6 weeks

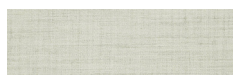
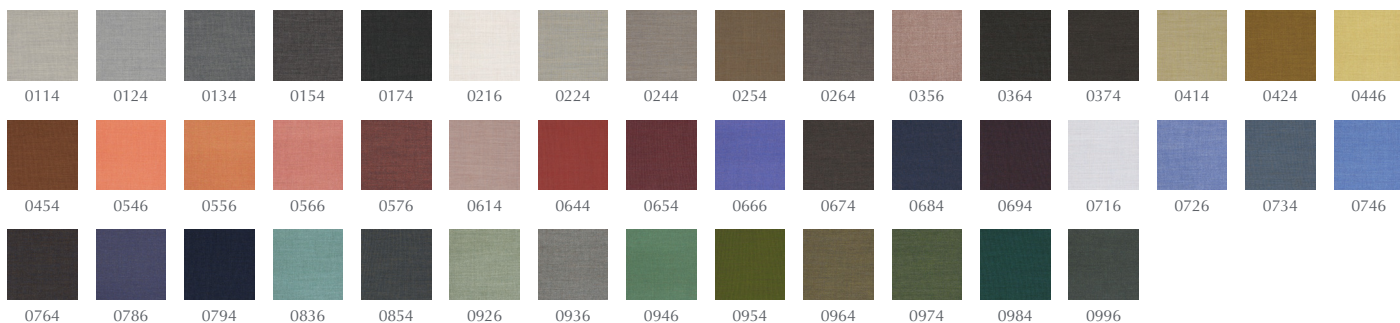

Remix 2 | Upholstery from Kvadrat

Remix 2 is an elegant woollen upholstery textile created by acclaimed designer Giulio Ridolfo. Featuring a plain, tight and minimalistic weave, Remix is made from melange yarns, and, consequently, offers exceptional colour

depth. These yarns comprise up to three colours and, as two differently coloured yarns are used to create every colourway, each combines up to six hues. This combination creates a lively play of irregular colours across the

fabric. Giulio Ridolfo: "Remix shows how beautiful a yarn can be and projects a strong sense of craftsmanship."

Name: Remix 2
 Designer: Giulio Ridolfo
 Type: Upholstery
 Pattern: Solid
 Composition: 90% New wool (worsted), 10% Nylon

Weight: 415 g/lin.m
 Width: 138 cm
 Durability: 100.000 Martindale
 Pilling: 4
 Lightfastness: 5-7

Sustainability: Complies with EU Ecolabel "The Flower"
 Manufactured in: United Kingdom
 Price: Upon request
 Delivery time: Within 6 weeks

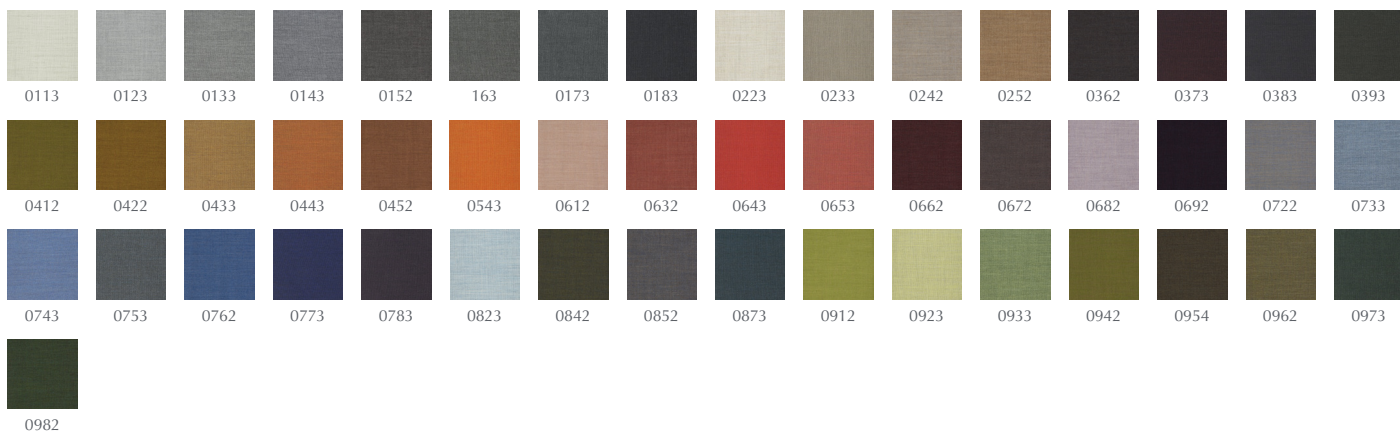



Harald 3 | Upholstery from Kvadrat

A closely-woven, very short-pile velour, Harald brings the fresh, soft texture of cotton to a directionless velvety textile. The intense colour offered by this matte velour places the focus strongly onto the silhouette of the up-

holstered object, emphasising its shape and contours. Originally designed by Fanny Aronsen, Harald comes in a new colour palette conceived by Raf Simons offering a particularly large selection of vivid keynote tones,

including primrose yellow, burnt orange, raspberry, lavender, aubergine and dark mint green, alongside more natural tones. Harald is a durable fabric suitable for use as curtains as well as in upholstery.

Name: Harald 3
Designer: Raf Simons & Fanny Aronsen
Type: Raf Simons upholstery
Pattern: Solid
Composition: 100% Cotton

Weight: 520 g/lin.m
Width: 140 cm
Durability: 100.000 Martindale
Pilling: 4-5
Lightfastness: 5

Sustainability: Natural fibres
Sustainable resource
Manufactured in: Italy
Price: Upon request
Delivery time: Within 6 weeks

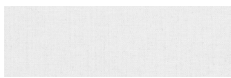
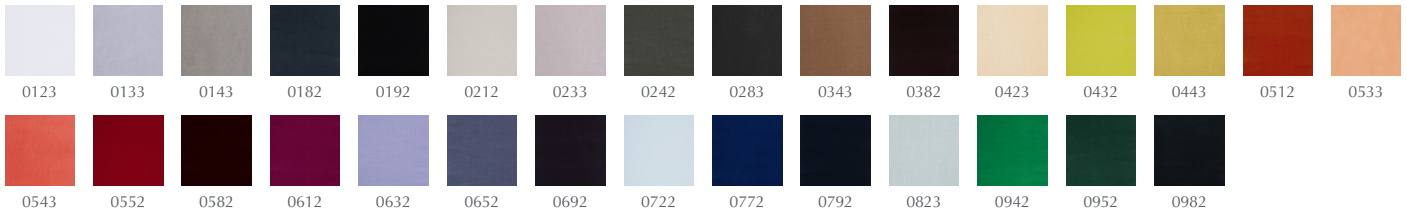

Maple | Upholstery from Kvadrat

Aero-finished and therefore extremely soft to the touch, Pine and Maple are made with three tone-in-tone coloured yarns. The viscose used in their construction gives them a distinctive shimmer, which deepens according

to the light and the perspective of the viewer. Pine is flat-woven and has a subtle striated look. Maple is woven with a chenille yarn and has a soft pile that reveals the structure of the weave. Foreign fibres and

small clusters of colour may appear on the textiles' surface adding to their slightly irregular, casual expression.

Name: Maple
Designer: Åsa Pärson
Type: Upholstery
Pattern: Solid
Composition: 81% Viscose, 15% Linen, 4% Polyester

Weight: 850 g/lin.m
Width: 140 cm
Durability: 30.000 Martindale
Pilling: 4-5
Lightfastness: 5-7

Sustainability: Natural fibres
Sustainable resource
Manufactured in: Turkey
Price: Upon request
Delivery time: Within 6 weeks



Re-wool | Upholstery from Kvadrat

Crafted using 45% recycled wool, Re-wool is a rich upholstery textile with a sustainable profile. The textile is partly made by reusing scraps from Kvadrat's yarn spinners in the UK. It is designed by Margrethe Odgaard. 'The

idea was to create a both honest and environmentally friendly – textile with a poetic feel by recycling leftover material from Kvadrat's own production', explains Margrethe Odgaard. Reminiscent of colourful stitchings on a

darker background, Re-wool features exceptional depth of colour, creating a dynamic play on the textile's surface when applied to furniture.

Name: Re-wool
Designer: Margrethe Odgaard
Type: Upholstery
Pattern: Solid
Composition: 45% New wool (worsted)
45% Recycled wool, 10% Nylon

Weight: 540 g/lin.m
Width: 140 cm
Durability: 50.000 Martindale
Pilling: 4
Lightfastness: 5-7

Sustainability: Complies with EU ecolabel
"The Flower"
Manufactured in: United Kingdom
Price: Upon request
Delivery time: Within 6 weeks

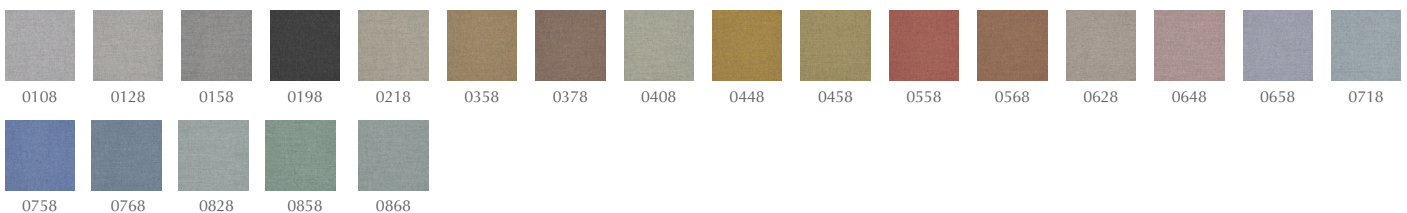

LIGHTING INFO

For inquiries & sales in Europe & rest of the world:

Most of our products are in stock in our warehouse in Copenhagen and in Texas in the US and can be delivered within 1 week. For more information about delivery, prices and sales conditions, please contact our sales office in Copenhagen in Denmark. If you are based in the US, please contact our sales office in New York.

UMAGE Aps

Sales office in Copenhagen
+45 31 39 31 31
info@umage.com | www.umage.com

UMAGE, Inc.

185 Wythe Avenue, Brooklyn, NY 11249
+1 646 790 7171
sales@umage.com | www.umage.com

LAMPS

ASTERIA

see page 123



Complete product	EU/UK/APAC	US	
	2170	2176	Asteria pearl white Ø 43 cm
	2206	2267	Asteria mini pearl white Ø 31 cm
	2171	2177	Asteria anthracite grey Ø 43 cm
	2207	2268	Asteria mini anthracite grey Ø 31 cm
	2172	2178	Asteria forest green Ø 43 cm
	2208	2269	Asteria mini forest green Ø 31 cm
	2173	2179	Asteria petrol blue Ø 43 cm
	2209	2270	Asteria mini petrol blue Ø 31 cm
	2174	2180	Asteria ruby red Ø 43 cm
	2210	2271	Asteria mini ruby red Ø 31 cm
	2175	2181	Asteria saffron yellow Ø 43 cm
	2211	2272	Asteria mini saffron yellow Ø 31 cm
	2182	2183	Asteria black Ø 43 cm
	2222	2273	Asteria mini black Ø 31 cm
	2420	N/A	Asteria nuance mist Ø 43 cm
	2430	N/A	Asteria mini nuance mist Ø 31 cm
	2421	N/A	Asteria nuance olive Ø 43 cm
	2431	N/A	Asteria mini nuance olive Ø 31 cm
	2422	N/A	Asteria nuance rose Ø 43 cm
	2432	N/A	Asteria mini nuance rose Ø 31 cm
	2423	N/A	Asteria nuance orange Ø 43 cm
	2433	N/A	Asteria mini nuance orange Ø 31 cm
	2170+4172	2176+4172	Asteria pearl white, steel metal cover incl. Ø 43 cm
	2206+4174	2267+4174	Asteria mini pearl white, steel metal cover incl. Ø 31 cm
	2171+4172	2177+4172	Asteria anthracite grey, steel metal cover incl. Ø 43 cm
	2207+4174	2268+4174	Asteria mini anthracite grey, steel metal cover incl. Ø 31 cm
	2172+4172	2178+4172	Asteria forest green, steel metal cover incl. Ø 43 cm
	2208+4174	2269+4174	Asteria mini forest green, steel metal cover incl. Ø 31 cm
	2173+4172	2179+4172	Asteria petrol blue, steel metal cover incl. Ø 43 cm
	2209+4174	2270+4174	Asteria mini petrol blue, steel metal cover incl. Ø 31 cm
	2174+4172	2180+4172	Asteria ruby red, steel metal cover incl. Ø 43 cm
	2210+4174	2271+4174	Asteria mini ruby red, steel metal cover incl. Ø 31 cm
	2175+4172	2181+4172	Asteria saffron yellow, steel metal cover incl. Ø 43 cm
	2211+4174	2272+4174	Asteria mini saffron yellow, steel metal cover incl. Ø 31 cm
	2182+4172	2183+4172	Asteria black, steel metal cover incl. Ø 43 cm
	2222+4174	2273+4174	Asteria mini black, steel metal cover incl. Ø 31 cm
	2420+4172	N/A	Asteria nuance mist, steel metal cover incl. Ø 43 cm
	2430+4174	N/A	Asteria mini nuance mist, steel metal cover incl. Ø 31 cm
	2421+4172	N/A	Asteria nuance olive, steel metal cover incl. Ø 43 cm
	2431+4174	N/A	Asteria mini nuance olive, steel metal cover incl. Ø 31 cm
	2422+4172	N/A	Asteria nuance rose, steel metal cover incl. Ø 43 cm
	2432+4174	N/A	Asteria mini nuance rose, steel metal cover incl. Ø 31 cm

ASTERIA		EU/UK/APAC	US	
	Complete product	2423+4172	N/A	Asteria nuance orange, steel metal cover incl. Ø 43 cm
		2433+4174	N/A	Asteria mini nuance orange, steel metal cover incl. Ø 31 cm
		2170+4173	2176+4173	Asteria pearl white, black metal cover incl. Ø 43 cm
		2206+4175	2267+4175	Asteria mini pearl white, black metal cover incl. Ø 31 cm
		2171+4173	2177+4173	Asteria anthracite grey, black metal cover incl. Ø 43 cm
		2207+4175	2268+4175	Asteria mini anthracite grey, black metal cover incl. Ø 31 cm
		2172+4173	2178+4173	Asteria forest green, black metal cover incl. Ø 43 cm
		2208+4175	2269+4175	Asteria mini forest green, black metal cover incl. Ø 31 cm
		2173+4173	2179+4173	Asteria petrol blue, black metal cover incl. Ø 43 cm
		2209+4175	2270+4175	Asteria mini petrol blue, black metal cover incl. Ø 31 cm
		2174+4173	2180+4173	Asteria ruby red, black metal cover incl. Ø 43 cm
		2210+4175	2271+4175	Asteria mini ruby red, black metal cover incl. Ø 31 cm
		2175+4173	2181+4173	Asteria saffron yellow, black metal cover incl. Ø 43 cm
		2211+4175	2272+4175	Asteria mini saffron yellow, black metal cover incl. Ø 31 cm
		2182+4173	2183+4173	Asteria black, black metal cover incl. Ø 43 cm
		2222+4175	2273+4175	Asteria mini black, black metal cover incl. Ø 31 cm
		2420+4173	N/A	Asteria nuance mist, black metal cover incl. Ø 43 cm
		2430+4175	N/A	Asteria mini nuance mist, black metal cover incl. Ø 31 cm
		2421+4173	N/A	Asteria nuance olive, black metal cover incl. Ø 43 cm
		2431+4175	N/A	Asteria mini nuance olive, black metal cover incl. Ø 31 cm
	2422+4173	N/A	Asteria nuance rose, black metal cover incl. Ø 43 cm	
	2432+4175	N/A	Asteria mini nuance rose, black metal cover incl. Ø 31 cm	
	2423+4173	N/A	Asteria nuance orange, black metal cover incl. Ø 43 cm	
	2433+4175	N/A	Asteria mini nuance orange, black metal cover incl. Ø 31 cm	
Accessories	4172	4172	Asteria steel metal cover Ø 6.3 cm	
	4174	4174	Asteria mini steel metal cover Ø 6.3 cm	
	4173	4173	Asteria black metal cover Ø 6.3 cm	
	4175	4175	Asteria mini black metal cover Ø 6.3 cm	

see page 123

ASTERIA FLOOR		EU/UK/APAC	US	
	2337	3018	Asteria floor pearl white Ø 43 cm	
	2338	3019	Asteria floor anthracite grey Ø 43 cm	
	2339	3020	Asteria floor forest green Ø 43 cm	
	2341	3022	Asteria floor ruby red Ø 43 cm	
	2340	3028	Asteria floor black Ø 43 cm	



see page 127





ASTERIA TABLE		EU/UK/APAC	US	
	2305	2311	Asteria table pearl white Ø 31 cm	
	2306	2312	Asteria table anthracite grey Ø 31 cm	
	2307	2313	Asteria table forest green Ø 31 cm	
	2309	2314	Asteria table ruby red Ø 31 cm	
	2308	2310	Asteria table black Ø 31 cm	

see page 129







ASTERIA MOVE		EU/UK/APAC	US	
	2385	N/A	Asteria Move pearl white Ø 20 cm	
	2386	N/A	Asteria Move anthracite grey Ø 20 cm	
	2387	N/A	Asteria Move forest green Ø 20 cm	
	2388	N/A	Asteria Move ruby red Ø 20 cm	
	2391	N/A	Asteria Move black Ø 20 cm	

see page 131

ASTERIA UP				EU/UK/APAC	US		<i>see page 133</i>
		2329	2335	Asteria Up pearl white Ø 60 cm			
		2330	2336	Asteria Up anthracite grey Ø 60 cm			
CASSINI				EU/UK/APAC	US		<i>see page 135</i>
		2360	N/A	Cassini medium Ø 40 cm			
		2361	N/A	Cassini mini Ø 20 cm			
HAZEL				EU/UK/APAC	US		<i>see page 137</i>
		2440	N/A	Hazel medium Ø 40 cm			
		2441	N/A	Hazel mini Ø 22 cm			
CHIMES				EU/UK/APAC	US		<i>see page 139</i>
		2165	N/A	Chimes oak Ø 3.4 cm			
		2167	N/A	Chimes dark oak Ø 3.4 cm			
		2265	N/A	Chimes black oak Ø 3.4 cm			
		2230	N/A	Chimes cluster 3 oak Ø 3.4 cm			
		2231	N/A	Chimes cluster 3 dark oak Ø 3.4 cm			
		2232	N/A	Chimes cluster 3 black oak Ø 3.4 cm			
		2233	N/A	Chimes tall oak Ø 3.4 cm			
		2234	N/A	Chimes tall dark oak Ø 3.4 cm			
		2235	N/A	Chimes tall black oak Ø 3.4 cm			
LAMPSHADES							
EOS EVIA				EU/UK	US/APAC*		<i>see page 145</i>
		2349	3026	Eos Evia white Ø 40 cm			
		2350	3027	Eos Evia large white Ø 55 cm			
EOS ESTHER				EU/UK	US/APAC*		<i>see page 147</i>
		2347	3024	Eos Esther medium W: 60 cm x 39 cm			
		2348	3025	Eos Esther large W: 75 cm x 49 cm			
EOS UP				EU/UK	US/APAC*		<i>see page 149</i>
		2142	2143	Eos Up mini white Ø 30 cm			
		2140	2150	Eos Up medium white Ø 40 cm			
		2141	3016	Eos Up large white Ø 70 cm			
EOS				EU/UK	US/APAC*		<i>see page 151</i>
		2091	3000	Eos micro white Ø 22 cm			
		2011	3001	Eos mini white Ø 35 cm			
		2010	3002	Eos medium white Ø 45 cm			
		2042	3003	Eos large white Ø 65 cm			
		2012	3004	Eos XL white Ø 75 cm			
		2041	3005	Eos XXL white Ø 110 cm			
		2022	3029	Eos mini red Ø 35 cm			
		2021	3030	Eos medium red Ø 45 cm			
		2023	3031	Eos large red Ø 65 cm			
		2123	3012	Eos micro light grey Ø 22 cm			
		2124	3013	Eos mini light grey Ø 35 cm			
		2085	3009	Eos medium light grey Ø 45 cm			

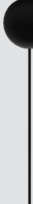
EOS	EU/UK	US/APAC*		
	2090	3010	Eos large light grey Ø 65 cm	
	2086	3011	Eos XL light grey Ø 75 cm	
	2125	3014	Eos micro light brown Ø 22 cm	
	2126	3015	Eos mini light brown Ø 35 cm	
	2066	3006	Eos medium light brown Ø 45 cm	
	2089	3007	Eos large light brown Ø 65 cm	
	2067	3008	Eos XL light brown Ø 75 cm	
	2046	3032	Eos mini light blue Ø 35 cm	
	2024	3033	Eos medium light blue Ø 45 cm	
	2047	3034	Eos large light blue Ø 65 cm	
	2298	N/A	Eos mini light rose Ø 35 cm	
	2300	N/A	Eos medium light rose Ø 45 cm	
	2299	N/A	Eos large light rose Ø 65 cm	
JAZZ see page 153				
	EU/UK/US/APAC			
	2216		Jazz oak Ø 65 cm	
	2218		Jazz dark oak Ø 65 cm	
2223		Jazz black oak Ø 65 cm		
ALUVIA see page 155				
	EU/UK/US/APAC			
	2121		Aluvia brushed brass Ø 59 cm	
	2122		Aluvia mini brushed brass Ø 40 cm	
	2127		Aluvia pearl white Ø 59 cm	
	2128		Aluvia mini pearl white Ø 40 cm	
	2129		Aluvia anthracite grey Ø 59 cm	
	2130		Aluvia mini anthracite grey Ø 40 cm	
	2131		Aluvia forest green Ø 59 cm	
	2132		Aluvia mini forest green Ø 40 cm	
	2133		Aluvia petrol blue Ø 59 cm	
	2134		Aluvia mini petrol blue Ø 40 cm	
	2135		Aluvia ruby red Ø 59 cm	
	2136		Aluvia mini ruby red Ø 40 cm	
	2137		Aluvia saffron yellow Ø 59 cm	
	2138		Aluvia mini saffron yellow Ø 40 cm	
	2146		Aluvia brushed bronze Ø 59 cm	
	2147		Aluvia mini brushed bronze Ø 40 cm	
ACORN see page 157				
	EU/UK/US/APAC			
	2081		Acorn black polished steel Ø 14 cm	
	2082		Acorn black polished brass Ø 14 cm	
	2083		Acorn black polished copper Ø 14 cm	
	2104		Acorn white polished steel Ø 14 cm	
	2105		Acorn white polished brass Ø 14 cm	
	2106		Acorn white polished copper Ø 14 cm	
	2214		Acorn smoked steel Ø 14 cm	
2215		Acorn amber brass Ø 14 cm		
CLAVA UP WOOD see page 159				
	EU/UK/APAC		US	
	2358		N/A	Clava Up Wood large oak / ash Ø 49 cm
	2381		N/A	Clava Up Wood medium oak / ash Ø 35 cm
	2359		N/A	Clava Up Wood large dark oak / ash Ø 49 cm
2382		N/A	Clava Up Wood medium dark oak / ash Ø 35 cm	

CLAVA UP WOOD		EU/UK/APAC	US		
	2369		N/A	Clava Up Wood large black oak / ash Ø 49 cm	
	2383		N/A	Clava Up Wood medium black oak / ash Ø 35 cm	
CLAVA DINE WOOD		EU/UK/US/APAC		see page 159	
	2343			Clava Dine Wood oak Ø 43 cm	
	2344			Clava Dine Wood dark oak Ø 43 cm	
	2362			Clava Dine Wood black oak Ø 43 cm	
CLAVA DINE		EU/UK/US/APAC		see page 163	
	2217			Clava Dine black Ø 43 cm	
	2301			Clava Dine red Ø 43 cm	
	2302			Clava Dine ochre Ø 43 cm	
	2303			Clava Dine umber Ø 43 cm	
	2304			Clava Dine slate Ø 43 cm	
	2097			Clava Dine polished steel Ø 43 cm	
	2098			Clava Dine brushed copper Ø 43 cm	
	2076			Clava Dine matt white Ø 43 cm	
	2099			Clava Dine brushed brass Ø 43 cm	
CLAVA		EU/UK/US/APAC		see page 165	
	2110			Clava polished steel Ø 21.5 cm	
	2111			Clava brushed copper Ø 21.5 cm	
	2051			Clava matt white Ø 21.5 cm	
	2112			Clava brushed brass Ø 21.5 cm	
CORNET		EU/UK/US/APAC		see page 167	
	2194			Cornet White & Brass W: 13.4 cm	
	2195			Cornet Black & Brass W: 13.4 cm	
CUNA		EU/UK/US/APAC		see page 169	
	2034			Cuna matt white Ø 38 cm	
	2035			Cuna matt black Ø 38 cm	
	2036			Cuna mint green Ø 38 cm	
SHADE		EU/UK/US/APAC		see page 171	
	2107			Shade felt grey Ø 33 cm	
SINE		EU/UK/US/APAC		see page 173	
	2084			Sine felt grey Ø 57 cm	
ACCESSORIES					
CHAMPAGNE		EU/APAC	UK*	US	see page 175
	4035		4043	4037	Champagne floor white H: 140 cm
	4036		4044	4038	Champagne floor black H: 140 cm
	4047		4047	4161	Champagne floor brushed steel H: 140 cm
	4048		4048	4160	Champagne floor brushed brass H: 140 cm
	4045		4045	4104	Champagne table white, w/USB, H: 42 cm
	4046		4046	4105	Champagne table black, w/USB, H: 42 cm
	4050		4050	4107	Champagne table brushed steel, w/USB, H: 42 cm
	4052		4052	4106	Champagne table brushed brass, w/USB, H: 42 cm

WILLOW	EU/APAC*	UK	US	
	4150	4154	N/A	Willow mini white H 50 cm
	4151	4155	N/A	Willow mini black H 50 cm
	4110	4146	4132	Willow single white H 123 cm
	4111	4147	4133	Willow single black H 123 cm
	4130	4148	4134	Willow double white H 123 cm
	4131	4149	4135	Willow double black H 123 cm
TRIPOD	EU/APAC*	UK	US	see page 179
	4053	4053	4055	Tripod base white H 18.6 cm
	4054	4054	4056	Tripod base black H 18.6 cm
	4021	4067	4023	Tripod table white H 36 cm
	4022	4068	4024	Tripod table black H 36 cm
	4015	4015	4011	Tripod floor white H 109 cm
	4016	4016	4012	Tripod floor black H 109 cm
UNIFIER	EU/UK/APAC	US		see page 181
	4186	N/A	Unifier white Ø 9.9 cm	
	4185	N/A	Unifier black Ø 9.9 cm	
CANNONBALL	EU/UK/APAC	US		see page 183
	4031	N/A	Cannonball white Ø 12 cm	
	4032	N/A	Cannonball black Ø 12 cm	
	4089	N/A	Cannonball white cluster 2 Ø 12 cm	
	4090	N/A	Cannonball white cluster 3 Ø 12 cm	
	4091	N/A	Cannonball black cluster 2 Ø 12 cm	
	4092	N/A	Cannonball black cluster 3 Ø 12 cm	
ROSETTE / CANOPY	EU/UK/APAC	US		see page 185
	4144	4007	Rosette / Canopy white Ø 14 cm	
	4145	4008	Rosette / Canopy black Ø 14 cm	
	N/A	4029	Canopy nickel Ø 14 cm	
	N/A	4030	Canopy oil rubbed bronze Ø 14 cm	
CORD SET	EU/UK/APAC	US		see page 187
	4005	N/A	Cord Set white Ø 11 cm E27	
	4006	N/A	Cord Set black Ø 11 cm E27	
SWAG KIT	EU/UK/APAC	US		see page 189
	N/A	4009	Swag Kit white E26	
	N/A	4010	Swag Kit black E26	
IDEA	EU/UK/APAC	US		see page 190-193
	4026	N/A	Idea LED A++ 60 mm / 6W - 2700 K	
	4033	N/A	Idea LED A++ 80 mm / 6.5W - 2700 K	
	4034	N/A	Idea LED A++ 125 mm / 3W - 2200 K	
	4039	N/A	Idea LED A+ 45 mm / 2W - 2200 K	
	4079	N/A	Idea LED A++ 45 mm / 4W - 2700 K	
	4136	N/A	Idea LED A+ 70 mm / 13W - 4000 K	
	4170	N/A	Idea LED A+ 80 mm / 2W - 2200 K	

IDEA	EU/UK/APAC	US	<i>see page 190-193</i>
	4171	N/A	Idea LED A+ 40 mm / 4W - 2700 K
	N/A	4040	Idea LED A++ 1.7" / 1.5W - 2200 K
	N/A	4042	Idea LED A+ 3.1" / 7W - 2700 K
	N/A	4103	Idea LED A++ 4.9" / 1.5 W - 2200 K

Scan the QR code to see recommended bulbs for your lampshade



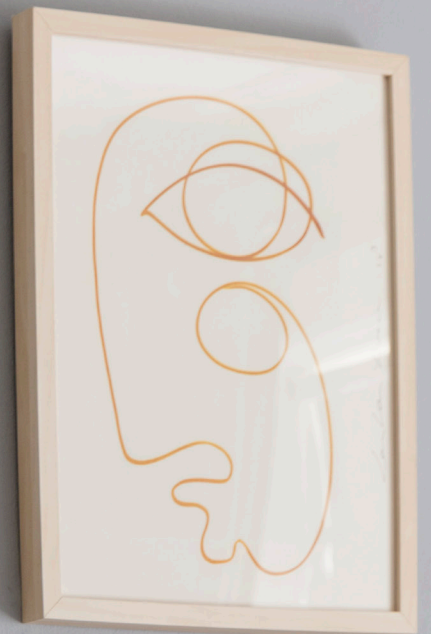

FURNITURE INFO

For inquiries & sales in Europe & rest of the world:

Most of our products are in stock in our warehouse in Copenhagen and in Texas in the US and can be delivered within 1 week. For more information about delivery, prices and sales conditions, please contact our sales office in Copenhagen in Denmark. If you are based in the US, please contact our sales office in New York.

UMAGE Aps

Sales office in Copenhagen
+45 31 39 31 31
info@umage.com | www.umage.com

UMAGE, Inc.

185 Wythe Avenue, Brooklyn, NY 11249
+1 646 790 7171
sales@umage.com | www.umage.com

SEATINGS

LOUNGE AROUND | sofa / daybed **EU/APAC** **UK*** **US*** *see page 195-205*

	3-seater sofa	5550+5550-1+5550-2	5550+5560-1+5560-2	5550+5551-1+5551-2	Lounge Around 3-seater sofa oak
		5750+5550-1+5550-2	5750+5560-1+5560-2	5750+5551-1+5551-2	Lounge Around 3-seater sofa dark oak
	1½-seater sofa	5562+5562-1	5562+5563-1	5562+5562-1	Lounge Around 1½-seater sofa oak
		5762+5562-1	5762+5563-1	5762+5562-1	Lounge Around 1½-seater sofa dark oak
	Daybed	5550+5550-1	5550+5551-1	5550+5560-1	Lounge Around daybed oak
		5750+5550-1	5750+5551-1	5750+5560-1	Lounge Around daybed dark oak
	Accessories	5405	5406	5407	Lean Back (backrest + back pillow)
		5400	5400	5408	Light Around white
		5401	5401	5409	Light Around black
		5403	5403	5403	Round Table oak
5404		5404	5404	Round Table dark oak	
5402		5402	5402	Side Pocket anthracite grey	

TIME FLIES | chair **EU/APAC** **UK*** **US*** *see page 207*

	Base	5900-1	5904-1	5907-1	Time Flies inner seat and back
	Legs	5901-1	5901-1	5901-1	Time Flies legs brass
		5901-2	5901-2	5901-2	Time Flies legs chrome
		5901-3	5901-3	5901-3	Time Flies legs black
	Seat	5902-1	5905-1	5908-1	Time Flies seat cover rusty brown
		5902-2	5905-2	5908-2	Time Flies seat cover forest green
		5902-3	5905-3	5908-3	Time Flies seat cover pale rose
		5902-4	5905-4	5908-4	Time Flies seat cover canary yellow
		5902-8	5905-8	5908-8	Time Flies seat cover tweed
		5902-9	5905-9	5908-9	Time Flies seat cover silver grey
		5910-1	N/A	N/A	Time Flies seat cover slate grey
		5910-2	N/A	N/A	Time Flies seat cover sand
		5910-3	N/A	N/A	Time Flies seat cover teddy white
		Back	5903-1	5906-1	5909-1
	5903-2		5906-2	5909-2	Time Flies back cover forest green
	5903-3		5906-3	5909-3	Time Flies back cover pale rose
	5903-4		5906-4	5909-4	Time Flies back cover canary yellow
	5903-6		5906-6	5909-6	Time Flies back cover tweed / hazelnut (faux leather)
	5903-7		5906-7	5909-7	Time Flies back cover silver grey / wellington
	5903-8		N/A	N/A	Time Flies back cover silver grey
5903-9	N/A		N/A	Time Flies back cover slate grey	
5911-1	N/A		N/A	Time Flies back cover sand	
5911-2	N/A		N/A	Time Flies back cover sand / burnt almond (faux leather)	
5911-3	N/A	N/A	Time Flies back cover teddy white		

A CONVERSATION PIECE LOW lounge chair		EU/APAC	UK*	US*	<i>see page 209</i>
Complete product		5501+5501-1	5501+5503-1	5501+5501-1	A Conversation Piece low oak petrol blue
		5501+5501-2	5539**	5501+5501-2	A Conversation Piece low oak silver grey
		5507**	N/A	5507**	A Conversation Piece low oak spring green
		5508**	5541**	5508**	A Conversation Piece low oak dusty rose
		5501+5501-5	5542**	5501+5501-5	A Conversation Piece low oak slate grey
		5501+5501-7	N/A	N/A	A Conversation Piece low oak teddy white
		5700+5501-1	5700+5503-1	5700+5501-1	A Conversation Piece low dark oak petrol blue
		5700+5501-2	5736	5700+5501-2	A Conversation Piece low dark oak silver grey
		5706**	N/A	5706**	A Conversation Piece low dark oak spring green
		5707**	5738	5707**	A Conversation Piece low dark oak dusty rose
		5708**	5739	5708**	A Conversation Piece low dark oak slate grey
		5700+5501-7	N/A	N/A	A Conversation Piece low dark oak teddy white
		5716	N/A	N/A	A Conversation Piece low dark oak sand
		5717	N/A	N/A	A Conversation Piece low dark oak brown
		5718	N/A	N/A	A Conversation Piece low dark oak cream
		5102+5501-1	5102+5503-1	5102+5501-1	A Conversation Piece low black oak petrol blue
		5102+5501-2	5102+5503-2	5102+5501-2	A Conversation Piece low black oak silver grey
		5102+5501-3	N/A	5102+5501-3	A Conversation Piece low black oak spring green
		5102+5501-4	5102+5503-4	5102+5501-4	A Conversation Piece low black oak dusty rose
		5102+5501-5	5102+5503-5	5102+5501-5	A Conversation Piece low black oak slate grey
5102+5501-7	N/A	N/A	A Conversation Piece low black oak teddy white		
Wooden bases only	5501	5501	5501	A Conversation Piece low wooden base oak	
	5700	5700	5700	A Conversation Piece low wooden base dark oak	
	5102	5102	5102	A Conversation Piece low wooden base black oak	
Upholstery (oak, dark oak & black oak)	5501-1	5503-1	5501-1	A Conversation Piece low upholstery petrol blue	
	5501-2	5503-2	5501-2	A Conversation Piece low upholstery silver grey	
	5501-3	N/A	5501-3	A Conversation Piece low upholstery spring green	
	5501-4	5503-4	5501-4	A Conversation Piece low upholstery dusty rose	
	5501-5	5503-5	5501-5	A Conversation Piece low upholstery slate grey	
	5501-7	N/A	N/A	A Conversation Piece low upholstery teddy white	

A CONVERSATION PIECE TALL lounge chair		EU/APAC	UK*	US*	<i>see page 211</i>
Complete product		5577+5577-1	N/A	5577+5577-1	A Conversation Piece tall oak petrol blue
		5577+5577-2	N/A	5577+5577-2	A Conversation Piece tall oak silver grey
		5577+5577-3	N/A	5577+5577-3	A Conversation Piece tall oak spring green
		5577+5577-4	N/A	5577+5577-4	A Conversation Piece tall oak dusty rose
		5577+5577-5	N/A	5577+5577-5	A Conversation Piece tall oak slate grey
		5577+5577-6	N/A	5577+5577-6	A Conversation Piece tall oak teddy white
		5872+5577-1	N/A	5872+5577-1	A Conversation Piece tall dark oak petrol blue
		5872+5577-2	N/A	5872+5577-2	A Conversation Piece tall dark oak silver grey
		5872+5577-3	N/A	5872+5577-3	A Conversation Piece tall dark oak spring green
		5872+5577-4	N/A	5872+5577-4	A Conversation Piece tall dark oak dusty rose
		5872+5577-5	N/A	5872+5577-5	A Conversation Piece tall dark oak slate grey
		5872+5577-6	N/A	N/A	A Conversation Piece tall dark oak teddy white
		5104+5577-1	N/A	5104+5577-1	A Conversation Piece tall black oak petrol blue
		5104+5577-2	N/A	5104+5577-2	A Conversation Piece tall black oak silver grey
		5104+5577-3	N/A	5104+5577-3	A Conversation Piece tall black oak spring green
		5104+5577-4	N/A	5104+5577-4	A Conversation Piece tall black oak dusty rose
		5104+5577-5	N/A	5104+5577-5	A Conversation Piece tall black oak slate grey
		5104+5577-6	N/A	N/A	A Conversation Piece tall black oak teddy white

*All upholstery on seating products (Lounge Around, Time Flies, A Conversation Piece & The Reader) are certified Fire Retardant

**Product currently delivered in one package will be switched to 2 packages when existing stock is over

A CONVERSATION PIECE TALL lounge chair		EU/APAC	UK*	US*	<i>see page 211</i>
Wooden bases only		5577	N/A	5577	A Conversation Piece tall wooden base oak
		5872	N/A	5872	A Conversation Piece tall wooden base dark oak
		5104	N/A	5104	A Conversation Piece tall wooden base black oak
Upholstery (oak, dark oak & black oak)		5577-1	N/A	5577-1	A Conversation Piece tall upholstery petrol blue
		5577-2	N/A	5577-2	A Conversation Piece tall upholstery silver grey
		5577-3	N/A	5577-3	A Conversation Piece tall upholstery spring green
		5577-4	N/A	5577-4	A Conversation Piece tall upholstery dusty rose
		5577-5	N/A	5577-5	A Conversation Piece tall upholstery slate grey
		5577-6	N/A	N/A	A Conversation Piece tall upholstery teddy white

A CONVERSATION PIECE ottoman		EU/APAC	UK	US	<i>see page 213</i>	
	Complete product	5573+5573-1	N/A	5573+5573-1	A Conversation Piece ottoman oak petrol blue	
		5573+5573-2	N/A	5573+5573-2	A Conversation Piece ottoman oak silver grey	
		5573+5573-3	N/A	5573+5573-3	A Conversation Piece ottoman oak spring green	
		5573+5573-4	N/A	5573+5573-4	A Conversation Piece ottoman oak dusty rose	
		5573+5573-5	N/A	5573+5573-5	A Conversation Piece ottoman oak slate grey	
		5573+5573-6	N/A	N/A	A Conversation Piece ottoman oak teddy white	
		5873+5573-1	N/A	5873+5573-1	A Conversation Piece ottoman dark oak petrol blue	
		5873+5573-2	N/A	5873+5573-2	A Conversation Piece ottoman dark oak silver grey	
		5873+5573-3	N/A	5873+5573-3	A Conversation Piece ottoman dark oak spring green	
		5873+5573-4	N/A	5873+5573-4	A Conversation Piece ottoman dark oak dusty rose	
		5873+5573-5	N/A	5873+5573-5	A Conversation Piece ottoman dark oak slate grey	
		5873+5573-6	N/A	N/A	A Conversation Piece ottoman dark oak teddy white	
		5105+5573-1	N/A	5105+5573-1	A Conversation Piece ottoman black oak petrol blue	
		5105+5573-2	N/A	5105+5573-2	A Conversation Piece ottoman black oak silver grey	
		5105+5573-3	N/A	5105+5573-3	A Conversation Piece ottoman black oak spring green	
		5105+5573-4	N/A	5105+5573-4	A Conversation Piece ottoman black oak dusty rose	
		5105+5573-5	N/A	5105+5573-5	A Conversation Piece ottoman black oak slate grey	
		5105+5573-6	N/A	N/A	A Conversation Piece ottoman black oak teddy white	
	Wooden bases		5573	N/A	5573	A Conversation Piece ottoman wooden base oak
			5873	N/A	5873	A Conversation Piece ottoman wooden base dark oak
		5105	N/A	5105	A Conversation Piece ottoman wooden base black oak	
Textile cover		5573-1	N/A	5573-1	A Conversation Piece ottoman petrol blue cover	
		5573-2	N/A	5573-2	A Conversation Piece ottoman silver grey cover	
		5573-3	N/A	5573-3	A Conversation Piece ottoman spring green cover	
		5573-4	N/A	5573-4	A Conversation Piece ottoman dusty rose cover	
		5573-5	N/A	5573-5	A Conversation Piece ottoman slate grey cover	
		5573-6	N/A	N/A	A Conversation Piece ottoman teddy white cover	

THE READER wing chair		EU/APAC	UK*	US*	<i>see page 215</i>
	Complete product	5502+5502-1	5502+5504-1	5502+5502-1	The Reader oak petrol blue
		5502+5502-2	5502+5504-2	5502+5502-2	The Reader oak silver grey
		5502+5502-3	N/A	5502+5502-3	The Reader oak spring green
		5502+5502-4	5502+5504-4	5502+5502-4	The Reader oak dusty rose
		5502+5502-5	5502+5504-5	5502+5502-5	The Reader oak slate grey
		5502+5502-7	N/A	N/A	The Reader oak teddy white
		5701+5502-1	5701+5504-1	5701+5502-1	The Reader dark oak petrol blue
		5701+5502-2	5741	5701+5502-2	The Reader dark oak silver grey
		5711**	N/A	5711**	The Reader dark oak spring green
		5701+5502-4	5701+5504-4	5701+5502-4	The Reader dark oak dusty rose

THE READER wing chair		EU/APAC	UK*	US*	see page 215
	Complete product	5701+5502-5	5701+5504-5	5701+5502-5	The Reader dark oak slate grey
		5701+5502-7	N/A	N/A	The Reader dark oak teddy white
		5103+5502-1	5103+5504-1	5103+5502-1	The Reader black oak petrol blue
		5103+5502-2	5103+5504-2	5103+5502-2	The Reader black oak silver grey
		5103+5502-3	N/A	5103+5502-3	The Reader black oak spring green
		5103+5502-4	5103+5504-4	5103+5502-4	The Reader black oak dusty rose
		5103+5502-5	5103+5504-5	5103+5502-5	The Reader black oak slate grey
		5103+5502-7	N/A	N/A	The Reader black oak teddy white
Wooden bases only	5502	5502	5502	The Reader wooden base oak	
	5701	5701	5701	The Reader wooden base dark oak	
	5103	5103	5103	The Reader wooden base black oak	
Upholstery (oak, dark oak & black oak)	5502-1	5504-1	5502-1	The Reader upholstery petrol blue	
	5502-2	5504-2	5502-2	The Reader upholstery silver grey	
	5502-3	N/A	5502-3	The Reader upholstery spring green	
	5502-4	5504-4	5502-4	The Reader upholstery dusty rose	
	5502-5	5504-5	5502-5	The Reader upholstery slate grey	
	5502-7	N/A	N/A	The Reader upholstery teddy white	

THE READER ottoman		EU/UK/US/APAC		see page 217
	Complete product	5583+5583-1	The Reader ottoman oak petrol blue	
		5583+5583-2	The Reader ottoman oak silver grey	
		5583+5583-3	The Reader ottoman oak spring green	
		5583+5583-4	The Reader ottoman oak dusty rose	
		5583+5583-5	The Reader ottoman oak slate grey	
		5588+5588-1	The Reader ottoman dark oak petrol blue	
		5588+5588-2	The Reader ottoman dark oak silver grey	
		5588+5588-3	The Reader ottoman dark oak spring green	
		5588+5588-4	The Reader ottoman dark oak dusty rose	
		5588+5588-5	The Reader ottoman dark oak slate grey	
		5116+5116-1	The Reader ottoman black oak petrol blue	
		5116+5116-2	The Reader ottoman black oak silver grey	
		5116+5116-3	The Reader ottoman black oak spring green	
		5116+5116-4	The Reader ottoman black oak dusty rose	
		5116+5116-5	The Reader ottoman black oak slate grey	
Wooden bases	5583	The Reader ottoman wooden base oak		
	5588	The Reader ottoman wooden base dark oak		
	5116	The Reader ottoman wooden base black oak		
Textile cover	5583-1	The Reader ottoman oak petrol blue cover		
	5583-2	The Reader ottoman oak silver grey cover		
	5583-3	The Reader ottoman oak spring green cover		
	5583-4	The Reader ottoman oak dusty rose cover		
	5583-5	The Reader ottoman oak slate grey cover		
	5588-1	The Reader ottoman dark oak petrol blue cover		
	5588-2	The Reader ottoman dark oak silver grey cover		
	5588-3	The Reader ottoman dark oak spring green cover		
	5588-4	The Reader ottoman dark oak dusty rose cover		
	5588-5	The Reader ottoman dark oak slate grey cover		
	5116-1	The Reader ottoman black oak petrol blue cover		
	5116-2	The Reader ottoman black oak silver grey cover		

THE READER ottoman		EU/UK/US/APAC		see page 217
	Textile cover	5116-3	The Reader ottoman black oak spring green cover	
		5116-4	The Reader ottoman black oak dusty rose cover	
		5116-5	The Reader ottoman black oak slate grey cover	

TABLES

COMFORT CIRCLE table		EU/UK/US/APAC		see page 219
	Complete product	5656+5656-1	Comfort Circle oak	
		5856+5856-1	Comfort Circle dark oak	
		5156+5156-1	Comfort Circle black oak	
	Top	5656	Comfort Circle legs oak	
		5856	Comfort Circle legs dark oak	
		5156	Comfort Circle legs black oak	
	Legs	5656-1	Comfort Circle top oak	
		5856-1	Comfort Circle top dark oak	
		5156-1	Comfort Circle top black oak	

MY SPOT side table		EU/UK/US/APAC		see page 221
		5571	My Spot oak / brass	
		5580	My Spot oak / steel	
		5771	My Spot dark oak / brass	
		5115	My Spot black oak / brass	

HANG OUT coffee table		EU/UK/US/APAC		see page 223
		5570	Hang Out oak / brass	
		5579	Hang Out oak / steel	
		5770	Hang Out dark oak / brass	
		5114	Hang Out black oak / brass	

AMBITIONS desk		EU/UK/US/APAC		see page 225
		5640+5640-1	Ambitions oak	
		5840+5840-1	Ambitions dark oak	

ONE MORE LOOK mirror		EU/UK/US/APAC		see page 227
	Complete product	5620+5620-1	One More Look oak pearl white	
		5620+5620-2	One More Look oak anthracite grey	
		5620+5620-3	One More Look oak forest green	
		5620+5620-4	One More Look oak petrol blue	
		5620+5620-5	One More Look oak ruby red	
		5620+5620-6	One More Look oak saffron yellow	
		5820+5620-1	One More Look dark oak pearl white	
		5820+5620-2	One More Look dark oak anthracite grey	
		5820+5620-3	One More Look dark oak forest green	
		5820+5620-4	One More Look dark oak petrol blue	
		5820+5620-5	One More Look dark oak ruby red	
		5820+5620-6	One More Look dark oak saffron yellow	
		5108+5620-1	One More Look black oak pearl white	
		5108+5620-2	One More Look black oak anthracite grey	
		5108+5620-3	One More Look black oak forest green	
		5108+5620-4	One More Look black oak petrol blue	
		5108+5620-5	One More Look black oak ruby red	
		5108+5620-6	One More Look black oak saffron yellow	

ONE MORE LOOK mirror		EU/UK/US/APAC		see page 227
	Mirror, shelf & cabinet unit only	5620	Mirror, shelf & cabinet oak	
		5820	Mirror, shelf & cabinet dark oak	
		5108	Mirror, shelf & cabinet black oak	
	Painted cabinet front only	5620-1	Cabinet front - Pearl white	
		5620-2	Cabinet front - Anthracite grey	
		5620-3	Cabinet front - Forest green	
		5620-4	Cabinet front - Petrol blue	
	5620-5	Cabinet front - Ruby red		
	5620-6	Cabinet front - Saffron yellow		

TRAYS		EU/UK/US/APAC		see page 229
		5419	Trays 3 pieces in silver grey (felt)	
		5420	Trays 3 pieces in slate grey (felt)	

TREASURES 2-door cabinet		EU/UK/US/APAC		see page 231
	Complete product	5622+5622-1	Treasures 2-door cabinet oak silver grey (fabric)	
		5622+5622-2	Treasures 2-door cabinet oak slate grey (fabric)	
		5622+5622-3	Treasures 2-door cabinet oak venetian cane	
		5622+5622-4	Treasures 2-door cabinet oak hazelnut (faux leather)	
		5774+5774-1	Treasures 2-door cabinet dark oak silver grey (fabric)	
		5774+5774-2	Treasures 2-door cabinet dark oak slate grey (fabric)	
		5774+5774-3	Treasures 2-door cabinet dark oak venetian cane	
		5774+5774-4	Treasures 2-door cabinet dark oak hazelnut (faux leather)	
		5106+5106-3	Treasures 2-door cabinet black oak venetian cane	
	Wooden bases	5622	Treasures 2-door cabinet oak frame	
		5774	Treasures 2-door cabinet dark oak frame	
		5106	Treasures 2-door cabinet black oak frame	
	Treasures doors	5622-1	Treasures doors oak silver grey (fabric)	
		5622-2	Treasures doors oak slate grey (fabric)	
		5622-3	Treasures doors oak venetian cane	
		5622-4	Treasures doors oak hazelnut (faux leather)	
		5774-1	Treasures doors dark oak silver grey (fabric)	
		5774-2	Treasures doors dark oak slate grey (fabric)	
		5774-3	Treasures doors dark oak venetian cane	
		5774-4	Treasures doors dark oak hazelnut (faux leather)	
	5106-3	Treasures doors black oak venetian cane		

TREASURES 3-door cabinet		EU/UK/US/APAC		see page 231
	Complete product	5623+5622-1	Treasures 3-door cabinet oak silver grey (fabric)	
		5623+5622-2	Treasures 3-door cabinet oak slate grey (fabric)	
		5623+5622-3	Treasures 3-door cabinet oak venetian cane	
		5623+5622-4	Treasures 3-door cabinet oak hazelnut (faux leather)	
		5775+5774-1	Treasures 3-door cabinet dark oak silver grey (fabric)	
		5775+5774-2	Treasures 3-door cabinet dark oak slate grey (fabric)	
		5775+5774-3	Treasures 3-door cabinet dark oak venetian cane	
		5775+5774-4	Treasures 3-door cabinet dark oak hazelnut (faux leather)	
		5107+5106-3	Treasures 3-door cabinet black oak venetian cane	
	Wooden bases	5623	Treasures 3-door cabinet oak frame	
		5775	Treasures 3-door cabinet dark oak frame	
		5107	Treasures 3-door cabinet black oak frame	

TREASURES 3-door cabinet		EU/UK/US/APAC		see page 231
	Treasures doors	5622-1	Treasures doors oak silver grey (fabric)	
		5622-2	Treasures doors oak slate grey (fabric)	
		5622-3	Treasures doors oak venetian cane	
		5622-4	Treasures doors oak hazelnut (faux leather)	
		5774-1	Treasures doors dark oak silver grey (fabric)	
		5774-2	Treasures doors dark oak slate grey (fabric)	
		5774-3	Treasures doors dark oak venetian cane	
		5774-4	Treasures doors dark oak hazelnut (faux leather)	
		5106-3	Treasures doors black oak venetian cane	

STORAGE

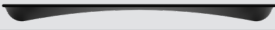
FLOW shelf		EU/UK/US/APAC		see page 233
		5418	Flow black ash	

TEASER shelf		EU/UK/US/APAC		see page 235
	Shelf	5004	Teaser pearl white	
		5005	Teaser anthracite grey	
		5006	Teaser forest green	
		5007	Teaser petrol blue	
		5008	Teaser ruby red	
		5009	Teaser saffron yellow	
	Shelf divider	5010	Space Rods brass	

AUDACIOUS cabinet		EU/UK/US/APAC		see page 237
	Complete product	5600+5600-1	Audacious oak petrol blue	
		5600+5600-2	Audacious oak silver grey	
		5600+5600-3	Audacious oak spring green	
		5600+5600-4	Audacious oak dusty rose	
		5600+5600-5	Audacious oak slate grey	
		5600+5600-6	Audacious oak hazelnut (faux leather)	
		5800+5600-1	Audacious dark oak petrol blue	
		5800+5600-2	Audacious dark oak silver grey	
		5800+5600-3	Audacious dark oak spring green	
		5800+5600-4	Audacious dark oak dusty rose	
		5800+5600-5	Audacious dark oak slate grey	
		5800+5600-6	Audacious dark oak hazelnut (faux leather)	
		5111+5600-1	Audacious black oak petrol blue	
		5111+5600-2	Audacious black oak silver grey	
		5111+5600-3	Audacious black oak spring green	
		5111+5600-4	Audacious black oak dusty rose	
		5111+5600-5	Audacious black oak slate grey	
		5111+5600-6	Audacious black oak hazelnut (faux leather)	
	Wooden bases	5600	Cabinet wooden base oak	
		5800	Cabinet wooden base dark oak	
		5111	Cabinet wooden base black oak	
	Tambour doors	5600-1	Tambour doors oak petrol blue	
		5600-2	Tambour doors oak silver grey	
		5600-3	Tambour doors oak spring green	
		5600-4	Tambour doors oak dusty rose	
		5600-5	Tambour doors oak slate grey	
		5600-6	Tambour doors oak hazelnut (faux leather)	

AUDACIOUS | side table
EU/UK/US/APAC
see page 239

	Complete product	5603+5603-1	Audacious side table oak petrol blue
		5603+5603-2	Audacious side table oak silver grey
		5603+5603-3	Audacious side table oak spring green
		5603+5603-4	Audacious side table oak dusty rose
		5603+5603-5	Audacious side table oak slate grey
		5603+5603-6	Audacious side table oak hazelnut (faux leather)
		5113+5603-1	Audacious side table black oak petrol blue
		5113+5603-2	Audacious side table black oak silver grey
		5113+5603-3	Audacious side table black oak spring green
		5113+5603-4	Audacious side table black oak dusty rose
		5113+5603-5	Audacious side table black oak slate grey
		5113+5603-6	Audacious side table black oak hazelnut (faux leather)
	Wooden base	5603	Side table wooden base oak
		5113	Side table wooden base black oak
	Tambour doors	5603-1	Tambour door oak petrol blue
		5603-2	Tambour door oak silver grey
		5603-3	Tambour door oak spring green
		5603-4	Tambour door oak dusty rose
		5603-5	Tambour door oak slate grey
5603-6		Tambour door oak hazelnut (faux leather)	

AUDACIOUS | tv bench
EU/UK/US/APAC
see page 241-243

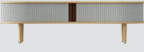
	Complete product	5601+5601-1	Audacious tv bench oak petrol blue
		5601+5601-2	Audacious tv bench oak silver grey
		5601+5601-3	Audacious tv bench oak spring green
		5601+5601-4	Audacious tv bench oak dusty rose
		5601+5601-5	Audacious tv bench oak slate grey
		5601+5601-6	Audacious tv bench oak hazelnut (faux leather)
		5112+5601-1	Audacious tv bench black oak petrol blue
		5112+5601-2	Audacious tv bench black oak silver grey
		5112+5601-3	Audacious tv bench black oak spring green
		5112+5601-4	Audacious tv bench black oak dusty rose
		5112+5601-5	Audacious tv bench black oak slate grey
		5112+5601-6	Audacious tv bench black oak hazelnut (faux leather)
	Wooden base	5601	Cabinet wooden base oak
		5112	Cabinet wooden base black oak
	Tambour doors	5601-1	Tambour doors oak petrol blue
		5601-2	Tambour doors oak silver grey
		5601-3	Tambour doors oak spring green
		5601-4	Tambour doors oak dusty rose
		5601-5	Tambour doors oak slate grey
5601-6		Tambour doors oak hazelnut (faux leather)	
Seat Cushion	5607	Cushion leather (faux leather)	

STORIES | shelving
EU/UK/US/APAC
see page 245-249

	Shelf	5621+5621-4	Stories 4 shelves oak, brass plate & 3 trays in venetian cane incl.
		5773+5773-4	Stories 4 shelves dark oak, brass plate & 3 trays in venetian cane incl.

STORIES shelving		EU/UK/US/APAC		see page 245-249
	Accessories (oak)	5621-1	Extra Shelf w/4 legs oak (add-on)	
		5621-2	Extra Shelf w/hole & 4 legs oak (add-on)	
		5621-3	Round Corner Table w/2 half legs oak (add-on)	
		5621-4	Trays 3 pieces in venetian cane oak	
	Accessories (dark oak)	5773-1	Extra Shelf w/4 legs dark oak (add-on)	
		5773-2	Extra Shelf w/hole & 4 legs dark oak (add-on)	
		5773-3	Round Corner Table w/2 half legs dark oak (add-on)	
		5773-4	Trays 3 pieces in venetian cane dark oak	
Other accessories	5413	Bowl		

STEP IT UP step stool		EU/UK/US/APAC		see page 251
	Complete product	5414	Step It Up pearl white	
		5415	Step It Up anthracite grey	
		5416	Step It Up ruby red	
		5417	Step It Up saffron yellow	

LEAN ON ME clothes rack		EU/UK/US/APAC		see page 253
	Complete product	5250	Lean On Me white	
		5251	Lean On Me black	

BUTTERFLIES hook		EU/UK/US/APAC		see page 255
	Complete product	5260	Butterflies mini pearl white	
		5261	Butterflies mini anthracite grey	
		5262	Butterflies mini forest green	
		5263	Butterflies mini petrol blue	
		5264	Butterflies mini ruby red	
		5265	Butterflies mini saffron yellow	
		5280	Butterflies medium pearl white	
		5281	Butterflies medium anthracite grey	
		5282	Butterflies medium forest green	
		5283	Butterflies medium petrol blue	
		5284	Butterflies medium ruby red	
		5285	Butterflies medium saffron yellow	



LIGHTING COLLECTION INDEX

LAMPSHADES



Eos Evia
page 144



Eos Esther
page 146



NEW

Eos Up
page 148

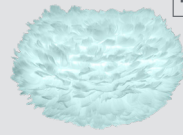

NEW

Eos
page 150



NEW

Jazz
page 152

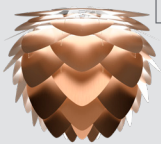

NEW

Aluvia
page 154



Acorn
page 156



NEW

Clava Up Wood
page 158

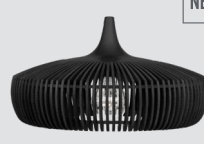

NEW

Clava Dine Wood
page 160



Clava Dine
page 162



Clava
page 164



Cornet
page 166



Cuna
page 168



Shade
page 170



Sine
page 172

LAMPS

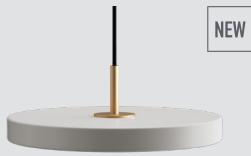

Asteria
page 122

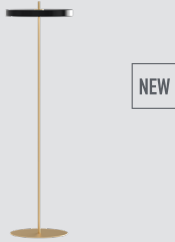

Asteria floor
page 126



Asteria table
page 128



Asteria Move
page 130

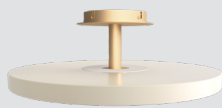

Asteria Up
page 132



Cassini
page 134



Hazel
page 136

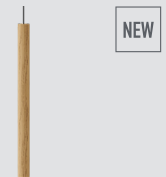

Chimes
page 138

ACCESSORIES

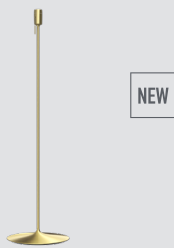

Champagne | light stand
page 174



Willow | wall stand
page 176



Tripod | light stand
page 178



Unifier | Qi wireless charger
page 180



Cannonball | canopy
page 182



Rosette | canopy
page 184



Cord Set
page 186



Swag Kit
page 188



Idea | bulbs
page 190

FURNITURE COLLECTION INDEX

SEATING



Lounge Around | sofa
page 194



Lounge Around | daybed
page 196



Lounge Around | 1.5-seater
page 198



Time Flies | chair
page 206



A Conversation Piece low | lounge chair
page 208



A Conversation Piece tall | lounge chair
page 210



A Conversation Piece | ottoman
page 212



The Reader | wing chair
page 214



The Reader | ottoman
page 216

TABLES



Comfort Circle | table
page 218



My Spot | side table
page 220



Hang Out | coffee table
page 222



Ambitions | desk
page 224

STORAGE



One More Look | mirror
page 226



Trays
page 228



Treasures | cabinet
page 230



Flow | shelf
page 232

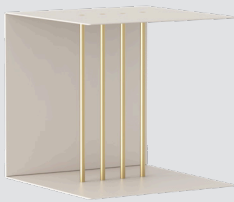

Teaser | shelf
page 234



Audacious | cabinet
page 236



Audacious | side table
page 238



Audacious | tv bench
page 240



Stories | shelving
page 244



Step It Up | step stool
page 250



Lean On Me | clothes rack
page 252

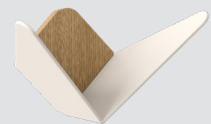

Butterflies | hook
page 254



umage.com @umagedesign #umagedesign

plastic change

We have entered the fight against plastic pollution and helping to minimize plastic waste in a collaboration the NGO Plastic Change.



Every time you buy a wooden furniture piece, we are planting a tree - making an effort for the environment.

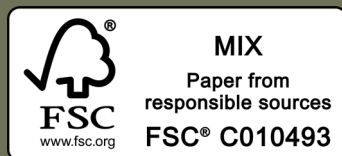

At UMAGE we make an effort for the environment, so this catalogue is printed on FSC®-certified paper to make sure the paper originates from responsibly managed forests.



